

Manitowoc 8500-1

Product Guide

ASME B30.5

Metric / Imperial



Features

- 80,0 t (85 USt) capacity
- 61 m (200 ft) heavy-lift boom
- Max boom + jib combination:
54,9 m (180 ft) + 18,3 m (60 ft)
- 213 kW (285 HP) engine
- 160 m/min (525 fpm) maximum line speed
- 75,6 kN (17,000 lb) rated line pull

Features

Energy saving systems

Green-Engine mode conserves fuel during full speed drum operation under load, at a lower engine RPM. Other available options include Green-Winch Mode and Auto Idling Stop Mode.



Self-erecting counterweight

Eliminates the need for an assist crane, and also allows for reduced counterweight chart operation.



Retractable crawlers

Crawlers can be extended and retracted for better jobsite maneuverability. On some models, these crawlers can also ship attached for easier transport and quicker setup.



Contents

Specifications	4
Outline dimensions	7
Winch performance data	12
Load chart notes	13
Boom combinations	14
Heavy-lift boom range / charts	16
Fixed jib boom range / load charts	18
Clamshell	21
Manitowoc Crane Care	22

Specifications

Upperworks



Engine

HINO J08E-UV, 6 cylinder, water-cooled diesel, direct fuel injection with turbocharger, 213 kW (285 HP) at 2100 high-idle RPM. Maximum torque 1017 N•m (750 lb•ft) net at 1,600 rpm; Interim Tier 4/ Stage IIIB (Required for sale in the US/Canada/ Europe; requires "Ultra Low Sulfur Diesel")

HINO J08E-VM, 6 cylinder, water-cooled diesel, direct fuel injection with turbocharger, 213 kW (285 HP) at 2100 high-idle RPM. Maximum torque 1017 N•m (750 lb•ft) net at 1,600 rpm; Tier 3 (Required for sale outside the US/Canada/Europe)

One diesel fuel tank, 400 liters (105 gallons) capacity.

Two 12 volt 136 AH capacity batteries, 24 volt system and 90 amp alternator.

All wiring harnesses and connectors are numbered for easier servicing. Machine is equipped with individual fused branch circuits.



Controls

Full-flow hydraulic control system for constant variable pressure to front and rear drums, boom hoist brakes and clutches. Controls respond instantly to the touch, delivering smooth function operation.

Relief valve pressures:

Load hoist, boom hoist and propel system	31.9 MPa (4,630 psi)
Swing system	27.5 MPa (3,989 psi)
Control system	5.4 MPa (783 psi)



Hydraulic system

All three variable displacement piston-type pumps are driven by a heavy-duty pump drive. One of these pumps is used in the right propel circuit and boom hoist circuit, and can accommodate an optional third circuit. Another is used in the left propel circuit and hook hoist circuit. The third variable displacement pump is used in the swing circuit. In addition, two gear pumps are used in the control system and auxiliary equipment, and two gear pumps serve the brake cooling system.

Maximum pressure rating31.9 MPa (4,630 psi)

Load hoist, boom hoist and propel	2 Piston pumps
Swing	1 Piston pump
Control system and auxiliary	2 Gear pumps
Brake cooling system	2 Gear pumps

Reservoir capacity 440 liter (116 US gallon)

Cooling: Oil-to-air heat exchanger (plate-fin type).

Filtration: Full-flow and bypass type with replaceable paper element.



Drums

Front and rear drums for load hoist powered by variable displacement piston-type motors, driven through planetary reducers. Powered hoisting/ lowering and free-fall operation is standard. Drum turn indicators for front and rear drums are also standard.

Brakes: spring set, hydraulically-released, multiple-disk holding brake is mounted on the hoist motor and is operated through a counter-balance valve. An external ratchet is fitted for locking the drums.

Drums: (front and rear) 545 mm (21.5") P.C.D. x 550 mm (21.7") wide drums, grooved for 22.0 mm wire rope.

Wire rope capacity:

Front drum	265 m (869 ft) working length
Rear drum	205 m (673 ft) working length

Line speed: Single line on the first drum layer

Hoisting: 120m/min (390 ft/min)

Lowering: 120m/min (390 ft/min)

▶ **Optional third drum:** free-fall is optional; drum grooved for 22 mm wire rope.

Wire rope working length 145m (476')



Swing system

Swing unit: Powered by a hydraulic piston-type motor driving spur gears through planetary reducers, the swing system provides 360° rotation.

Swing brake: A spring-set, hydraulically released multiple-disc brake is mounted on swing motor.

Swing lock: 4-Position lock for transportation.

Rotating bed turntable: Single-row ball bearing with an integral internally cut swing gear.

Swing speed: 4.0 rpm

Specifications



Boom support system

Single drum powered by a hydraulic axial piston motor through a planetary reducer.

Brake: A spring-set, hydraulically released multiple-disc brake is mounted on the boom hoist motor. An external ratchet is fitted for locking the drum.

Drum: Single drum, grooved for 16 mm diameter wire rope. Boom hoist reeving is 12-part line.

Wire Rope Capacity:

Drum 150 m (492 ft) working length.

Line speed:

Hoisting 70m/min (230 ft/min)

Lowering 70m/min (230 ft/min)



Gantry

This high folding type gantry is fitted with a sheave frame for boom hoisting. Hydraulic lift is standard. It provides full up, full down positions.



Counterweight

Upper weight (5 pieces): 26,120 kg (57,584 lb)
Carbody weight (2 pieces): 6,500 kg (14,330 lb)



Operator's cab

Totally enclosed, full vision cab fitted with tinted safety glass and opening front window. A fully adjustable, highbacked seat with arm rests. Short handle control levers; electronic twist grip hand throttle. An air conditioner, a signal horn and windshield wiper are standard.

Lights:

2 - Front flood lights
1 - Cab inside light

Safety device

New easy to read at a glance LMI and maintenance display.

Lowerworks



Carbody

The durable carbody features steel welded construction with extendible axles.



Crawlers

Crawler assemblies can be hydraulically extended for wide-track operation. Crawler belt tension adjusted with hydraulic jack and maintained by shims between idler block and frame.

The independent hydraulic propel drive is built into each crawler side frame. Each drive consists of a hydraulic motor driving a propel sprocket through a planetary gearbox. The hydraulic motor and gearbox are built into the crawler side frame within the shoe width. The track rollers are sealed for maintenance-free operation.

Crawler shoes

914 mm (36") wide crawler.

Travel speed

(High/Low) 1.73/1.2 km/h (1.07/0.71 mph)

Attachments



Boom

Welded lattice construction using tubular, high-tensile steel chords with pin connections between sections. Two idler sheaves and four point sheaves are standard.

Basic boom length 12,2 m (40') consists of the boom butt section 5,8 m (19') and boom top section 6,39 m (21').

Optional boom inserts are available to provide extension capabilities. They also have welded lattice construction with tubular, high-tension steel chords and pin connections on each one of the 3,0 m (10'), 6,1 m (20'), 12,2 m (40') inserts.

Maximum total length of boom 61,0 m (200').



Fixed jib

The optional fixed jib employs welded lattice construction with tubular, high-tensile steel chords with pin connections between sections.

Basic jib length 9,14 m (30') consists of jib butt section 4,57 m (15') and jib top section 4,57 (15').

Optional jib boom inserts of 3,0 m (10'), 6,1 m (20') are available for extension capabilities up to 18 m (60').

Maximum total length of boom and jib 54,9 m (180') + 18 m (60') is 73,1 m (240').

Specifications

Tools and accessories

A set of tools and accessories are furnished.

Optional Equipment

- ▶ Optional: blocks and hooks each with roller bearing sheaves grooved for 22 mm diameter wire rope, and roller bearing swivel with hook latch.
- ▶ 7,7 t ball hook, 160 kg, wedge socket for 22 mm wire rope. (12 USt ball hook, 722 lb wedge socket for 22 mm wire rope.)
- ▶ 19 t hook block, 400 kg with one 500 mm Nominal O.D. roller bearing sheave.
- ▶ 32 t hook block, 500 kg with two 500 mm Nominal O.D. roller bearing sheaves.
- ▶ 60 USt hook block, 2,486 lb, with four 24" Nominal O.D. roller bearing sheaves.
- ▶ 80 t hook block, 800 kg, with five 500 mm Nominal O.D. roller bearing sheaves. (90 USt hook block, 2,892 lb with five 24" Nominal O.D. roller bearing sheaves.)
- ▶ Optional: Detachable upper boom point with one 561 mm Nominal O. D. roller bearing steel sheave grooved for 22 mm rope for liftcrane.

Working weight

Approximately 75,100 kg (165,600 lb) including upperworks and lowerworks, full upper counterweights, full carbody counterweights and 12,2 m (40') basic boom.

Ground pressure

Approximately 74,2 kPa (10.8 psi) with basic boom.

Gradeability

With basic boom: 40%.

SALE & RENTAL

Outline dimensions

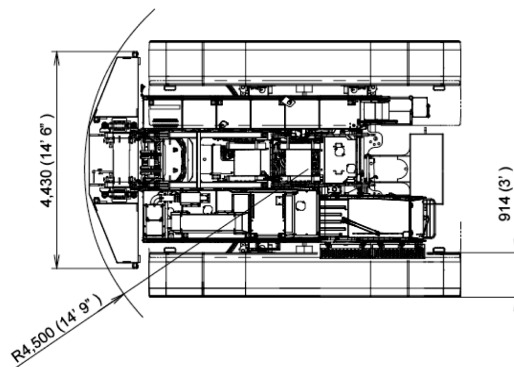
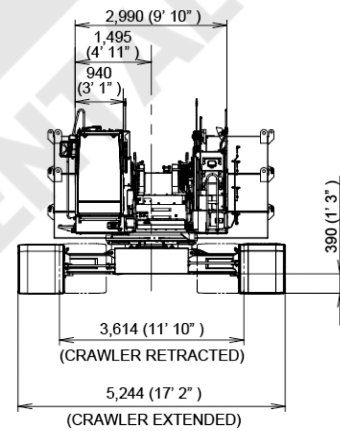
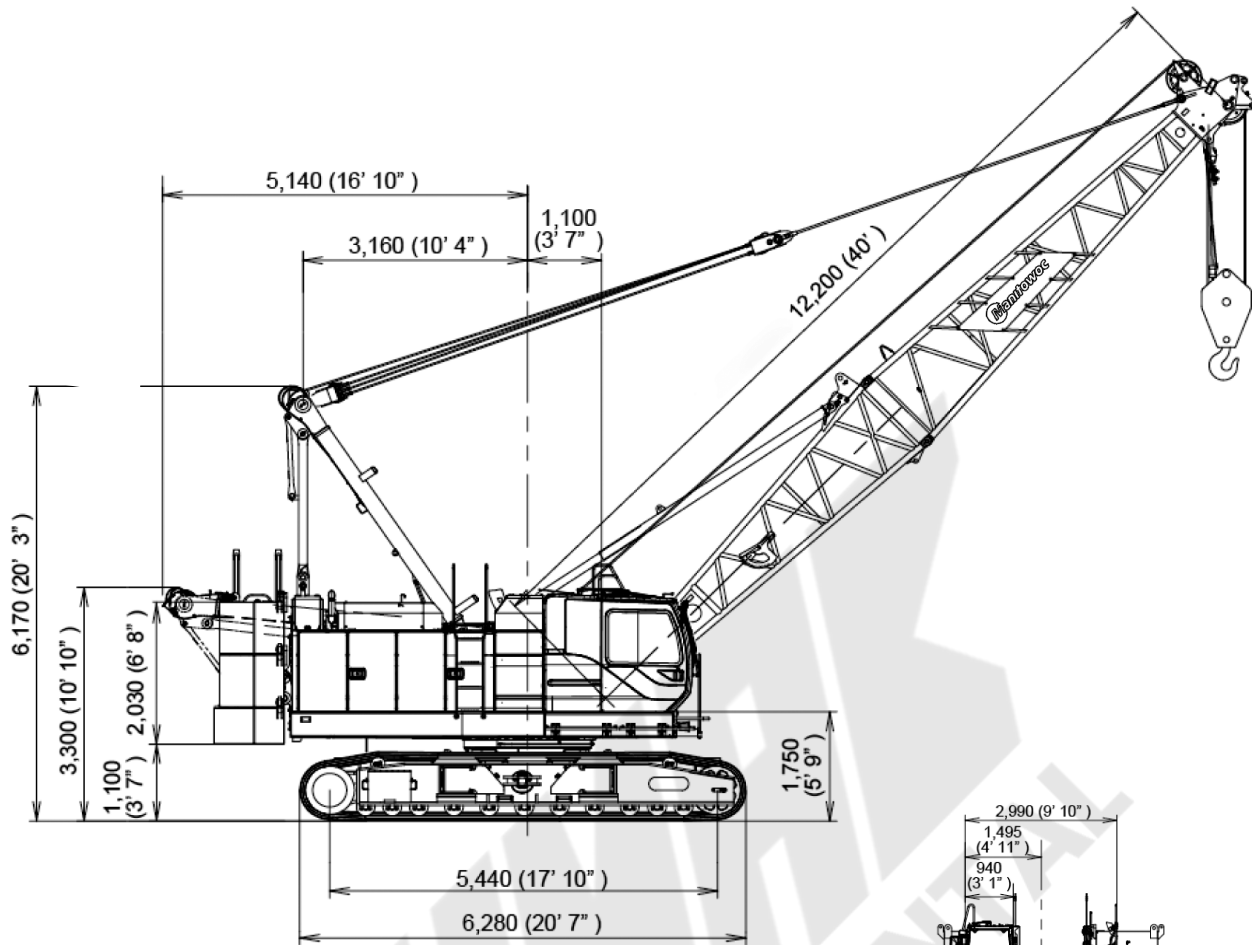

Outline dimensions

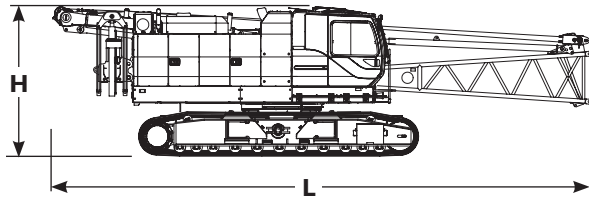

Upperworks x 1

Length	12,09 m	39' 8"
Width	3,61 m	11' 10"
Height	3,30 m	10' 10"
Weight	41 580 kg	91,677 lb

Note: Weight includes base machine, crawler, gantry, maximum hoist and whip lines on drums, boom butt, full hydraulic fluid reservoir, and one third tank of fuel.

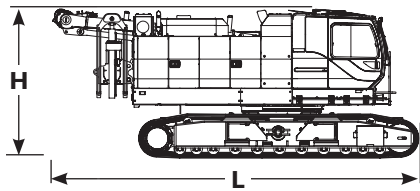

Upperworks x 1

Length	8,21 m	27' 0"
Width	3,61 m	11' 10"
Height	3,30 m	10' 10"
Weight	39 660 kg	87,434 lb

Note: Weight includes base machine, crawler, gantry, maximum hoist and whip lines on drums, full hydraulic fluid reservoir, and one third tank of fuel.

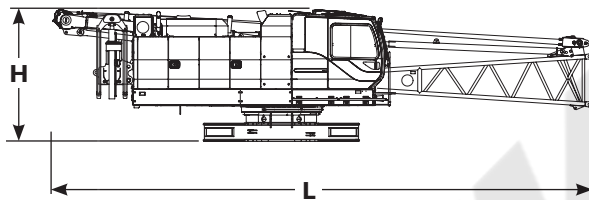

Upperworks without crawlers x 1

Length	12,09 m	39' 8"
Width	2,99 m	9' 10"
Height	2,91 m	9' 7"
Weight	26 330 kg	57,981 lb

Note: Weight includes base machine, gantry, maximum hoist and whip lines on drums, boom butt, full hydraulic fluid reservoir, and one third tank of fuel.

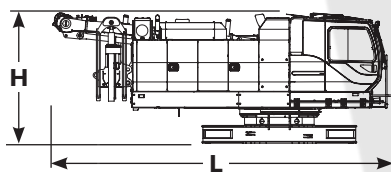

Upperworks without crawlers x 1

Length	7,70 m	25' 3"
Width	2,99 m	9' 10"
Height	2,94 m	9' 8"
Weight	24 380 kg	53,748 lb

Note: Weight includes base machine, gantry, maximum hoist and whip lines on drums, full hydraulic fluid reservoir, and one third tank of fuel.

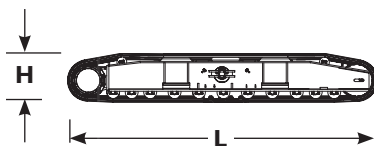

Crawlers x 2

Length	6,28 m	20' 7"
Width	0,91 m	3' 0"
Height	0,98 m	3' 3"
Weight	7 640 kg	16,843 lb

Option

Outline dimensions

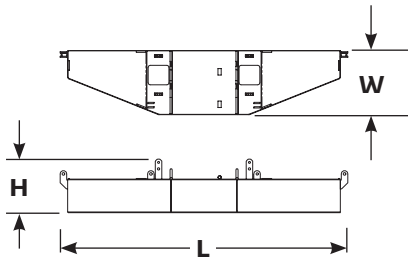

Upper counterweight		x 1
Length	4,43 m	14' 6"
Width	0,99 m	3' 3"
Height	0,83 m	2' 9"
Weight	9 320 kg	20,550 lb

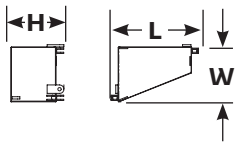

Upper counterweight (R)		x 2
Length	1,45 m	4' 9"
Width	0,95 m	3' 1"
Height	0,88 m	2' 11"
Weight	4 200 kg	9,260 lb

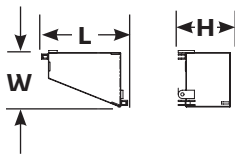

Upper counterweight (L)		x 2
Length	1,45 m	4' 9"
Width	0,95 m	3' 1"
Height	0,88 m	2' 11"
Weight	4 200 kg	9,260 lb

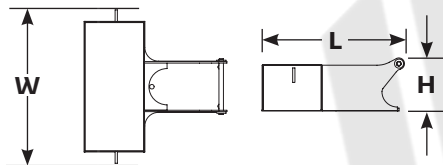

Carbody counterweight		x 2
Length	1,58 m	5' 2"
Width	1,69 m	5' 7"
Height	0,59 m	1' 11"
Weight	3 250 kg	7,165 lb

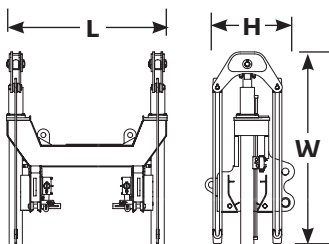

Self removal unit		x 1
Length	1,59 m	5' 3"
Width	1,90 m	6' 3"
Height	0,88 m	2' 11"
Weight	860 kg	1,896 lb

WARRANTY SALE & RENTAL

Outline dimensions

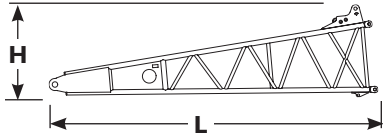

Boom butt 5,8 m (19')		
Length	5,97 m	19' 7"
Width	1,42 m	4' 8"
Height	1,69 m	5' 7"
Weight	1 055 kg	2,326 lb

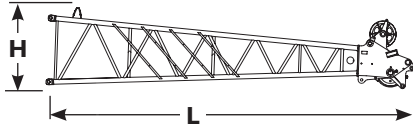

Boom top 6,4 m (21')		
Length	6,90 m	22' 8"
Width	1,38 m	4' 6"
Height	1,48 m	4' 10"
Weight	1 010 kg	2,227 lb

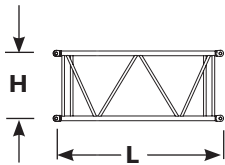

Boom insert 3,0 m (10')		
Length	3,16 m	10' 4"
Width	1,36 m	4' 6"
Height	1,31 m	4' 4"
Weight	270 kg	590 lb

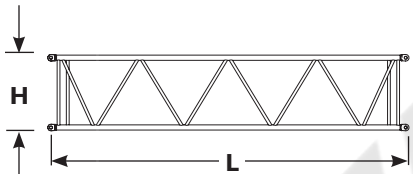

Boom insert 6,10 m (20')		
Length	6,21 m	20' 5"
Width	1,36 m	4' 6"
Height	1,31 m	4' 4"
Weight	465 kg	1,025 lb

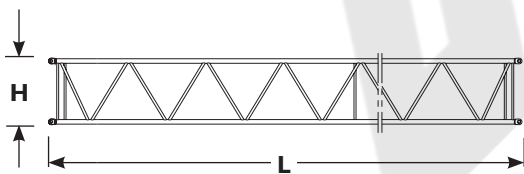

Boom insert 12,2 m (40')		
Length	12,31 m	40' 5"
Width	1,36 m	4' 6"
Height	1,31 m	4' 4"
Weight	860 kg	1,896 lb

Note: Use one "A" type insert with lug required for any boom combinations that require a 12,2 m (40') insert.

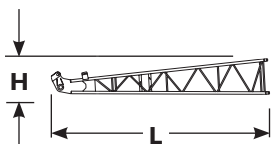

Fixed jib butt		
Length	4,81 m	15' 9"
Width	0,80 m	2' 8"
Height	0,80 m	2' 8"
Weight	200 kg	440 lb

Option

Outline dimensions

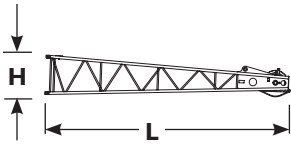

Fixed jib top x 1		
Length	4,91 m	16' 1"
Width	0,79 m	2' 7"
Height	0,80 m	2' 8"
Weight	220 kg	485 lb

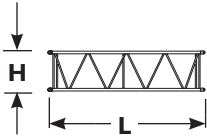

Fixed jib insert 3,0 (10') x 1		
Length	3,11 m	10' 2"
Width	0,80 m	2' 8"
Height	0,80 m	2' 8"
Weight	95 kg	210 lb

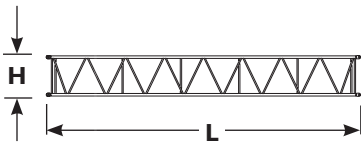

Fixed jib insert 6,1 m (20') x 1		
Length	6,16 m	20' 3"
Width	0,80 m	2' 8"
Height	0,80 m	2' 8"
Weight	175 kg	390 lb

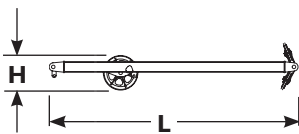

Fixed jib strut x 1		
Length	3,62 m	11' 11"
Width	0,84 m	2' 9"
Height	0,50 m	1' 8"
Weight	207 kg	456 lb

WRENTA
SALE & RENTAL

Winch performance data

Line pull		
	Rated line pull kg (lb)	*Maximum line pull kg (lb)
Front drum	7700 (17,000)	15,600 (34,400)
Rear drum	7700 (17,000)	15,600 (34,400)
Optional 3rd drum	7700 (17,000)	15,600 (34,400)

* Maximum line pull is not based on wire rope strength.

Wire rope specifications				
Use	Specs	Diameter mm (in)	Working length m (ft)	Breaking strength kg (lb)
Front drum	IWRCC/O 6 X Fi (29)	22,0	265 (869)	37 015 (81,570)
Rear drum	IWRCC/O 6 X Fi (29)	22,0	205 (672)	37 015 (81,570)
Boom hoist drum	IWRCC/O 6 X Fi (31)	22,0	150 (492)	21 400 (47,210)
Optional 3rd drum	IWRCC/O 6 X Fi (29)	22,0	145 (476)	37 015 (81,570)

Front and rear winch							
Layer		Line speed m/min (ft/min)					
		1	2	3	4	5	6
Rated line pull	Single line pull kg (lb)						
	0 (0)	120 (394)	128 (420)	136 (446)	144 (495)	152 (499)	160 (525)
	2 268 (5,000)	120 (394)	128 (420)	136 (466)	144 (495)	152 (499)	160 (525)
	4 536 (10,000)	108 (353)	108 (353)	108 (353)	108 (353)	108 (353)	108 (353)
	6 804 (15,000)	72 (235)	72 (235)	72 (235)	72 (235)	72 (235)	72 (235)
	7 711 (17,000)	63 (208)	63 (208)	63 (208)	63 (208)	63 (208)	63 (208)
	9 072 (20,000)	54 (176)	54 (176)	54 (176)	54 (176)	55 (179)	56 (182)
	11 340 (25,000)	43 (141)	44 (146)	45 (148)	45 (149)	45 (149)	–
	13 608 (30,000)	38 (123)	–	–	–	–	–

NOTE: Line speeds and line pull based on single line.
Line pulls are not based on wire rope strength.

Load chart notes

- Rated loads included in the charts are the maximum allowable freely suspended loads at a given boom length, boom angle and load radius, and have been determined for the machine standing level on firm supporting surface under ideal operating conditions. The user must limit or de-rate rated loads to allow for adverse conditions (such as soft or uneven ground, out-of-level conditions, wind side loads, pendulum action, jerking or sudden stopping of loads, inexperience of personnel, multiple machine lifts, and traveling with a load).
- Capacities do not exceed 75% of minimum tipping loads. Capacities based on factors other than machine stability such as structural competence are shown by asterisk * in the charts.
- The machine must be reeved and set-up as stated in the operation manual and all the instruction manuals. If these manuals are missing, obtain replacements. Boom backstops are required for all boom lengths. Gantry must be in the fully raised position for all operations. Crawlers must be fully extended and be locked in position. The crane must be leveled to within 1% on a firm supporting surface.
- Do not attempt to lift where no radius or load is listed as crane may tip or collapse.
- Attempting to lift more than rated loads may cause machine to tip or collapse. Do not tip machine to determine capacity.
- Weight of hooks, hook blocks, slings and other lifting devices are a part of the total load. Their total weight must be subtracted from the rated load to obtain the weight that can be lifted.
- When lifting over boom point with jib or upper boom point installed, rated loads for the boom must be deducted as shown below.

Jib length m (ft)	Upper boom point	9,1 (30)	12,2 (40)	15,2 (50)	18,3 (60)
Deduct kg (lb)	200 (320)	1100 (2,400)	1500 (3,200)	2000 (4,200)	2400 (5,200)

- The total load that can be lifted by the jib is limited by rated jib loads.
- Boom lengths for jib mounting are 24,4 m (80 ft) to 54,9 m (180 ft).
- The total load that can be lifted by the upper boom point is: the rated load for the boom (without upper boom point installed) minus 200 kg (320 lb); however, the upper boom point rated load should not exceed 7 700 kg (17,000 lb).

- An upper boom point cannot be used on a 61 m (200 ft) boom length.
- The boom should be erected over the front of the crawlers, not laterally. When erecting and lowering the boom with a length of 54,9 m (180 ft) with jib, blocking must be placed at the end of the crawlers. See operator's manual for details.
- Least stable position is over the side.
- Maximum hoist load for number of reeving parts of line for hoist rope.

Maximum load for main boom

No. of parts of line	1	2	3	4	5
Maximum loads kg (lb)	7 700 (17,000)	15 400 (34,000)	23 100 (51,000)	30 800 (68,000)	38 500 (85,000)

No. of parts of line	6	7	8	9	10
Maximum loads kg (lb)	46 200 (102,000)	53 900 (119,000)	61 600 (136,000)	69 400 (153,000)	80 000 (177,000)

Maximum load for fixed jib

No. of parts of line	1	2
Maximum loads kg (lb)	7 700 (17,000)	10 800 (24,000)

Maximum load for upper boom point

No. of parts of line	1
Maximum loads kg (lb)	7 700 (17,000)

- Lifting capacities listed apply only to the machine as originally manufactured for and supplied by Manitowoc Cranes, Inc. Modifications to this machine or use of equipment other than that specified can reduce operating capacity.
- Designed and rated to comply with ASME Code B30.5.

Operation of this equipment in excess of rated loads or disregard of instruction voids the warranty.

Boom combinations

No. 8500-1 heavy-lift boom combinations

Boom length m (ft)	Boom inserts		
	3,1 m (10 ft)	6,1 m (20 ft)	12,2 m (40 ft)
12,2 (40)	–	–	–
15,2 (50)	1	–	–
18,3 (60)	2	–	–
21,3 (70)	1	1	–
24,4 (80)	2	1	–
27,4 (90)	1	2	–
30,5 (100)	2	2	–
33,5 (110)	1	1	1*
36,6 (120)	2	1	1*
39,6 (130)	1	2	1*
42,7 (140)	2	2	1*
45,7 (150)	1	1	2*
48,8 (160)	2	1	2*
51,8 (170)	1	2	2*
54,9 (180)	2	2	2*
57,9 (190)	1	1	3*
61,0 (200)	2	1	3*

* NOTE: One 40 ft (12,20 m) boom insert with lug 40A is required for fixed jib. When no jib is installed a 40 ft (12,20 m) boom can be used instead of 40A.

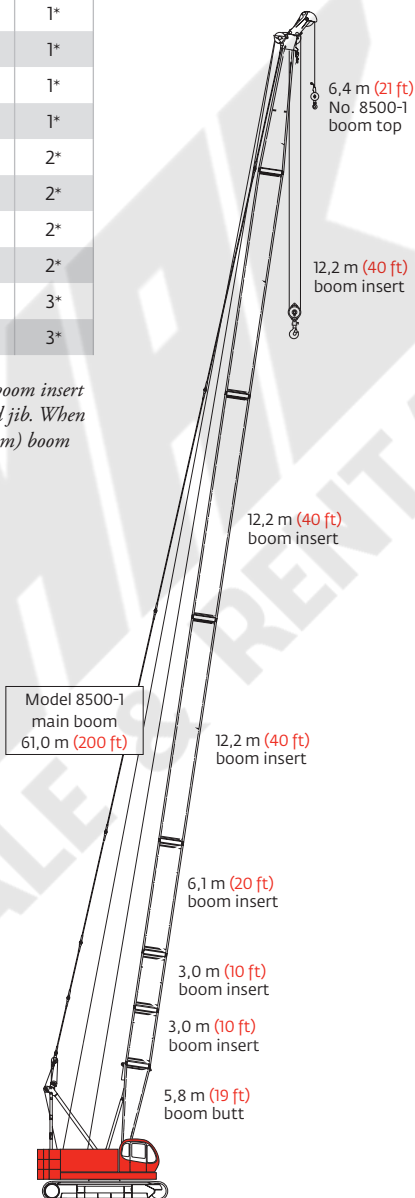

Model 8500-1
Main boom 61,0 m (200 ft)

Boom combinations

No. 8500-1 fixed jib combinations		
Fixed jib length m (ft)	Fixed jib inserts	
	3,1 m (10 ft)	6,1 m (20 ft)
9,1 (30)	–	–
12,2 (40)	1	–
15,2 (50)	–	1
18,3 (60)	1	1

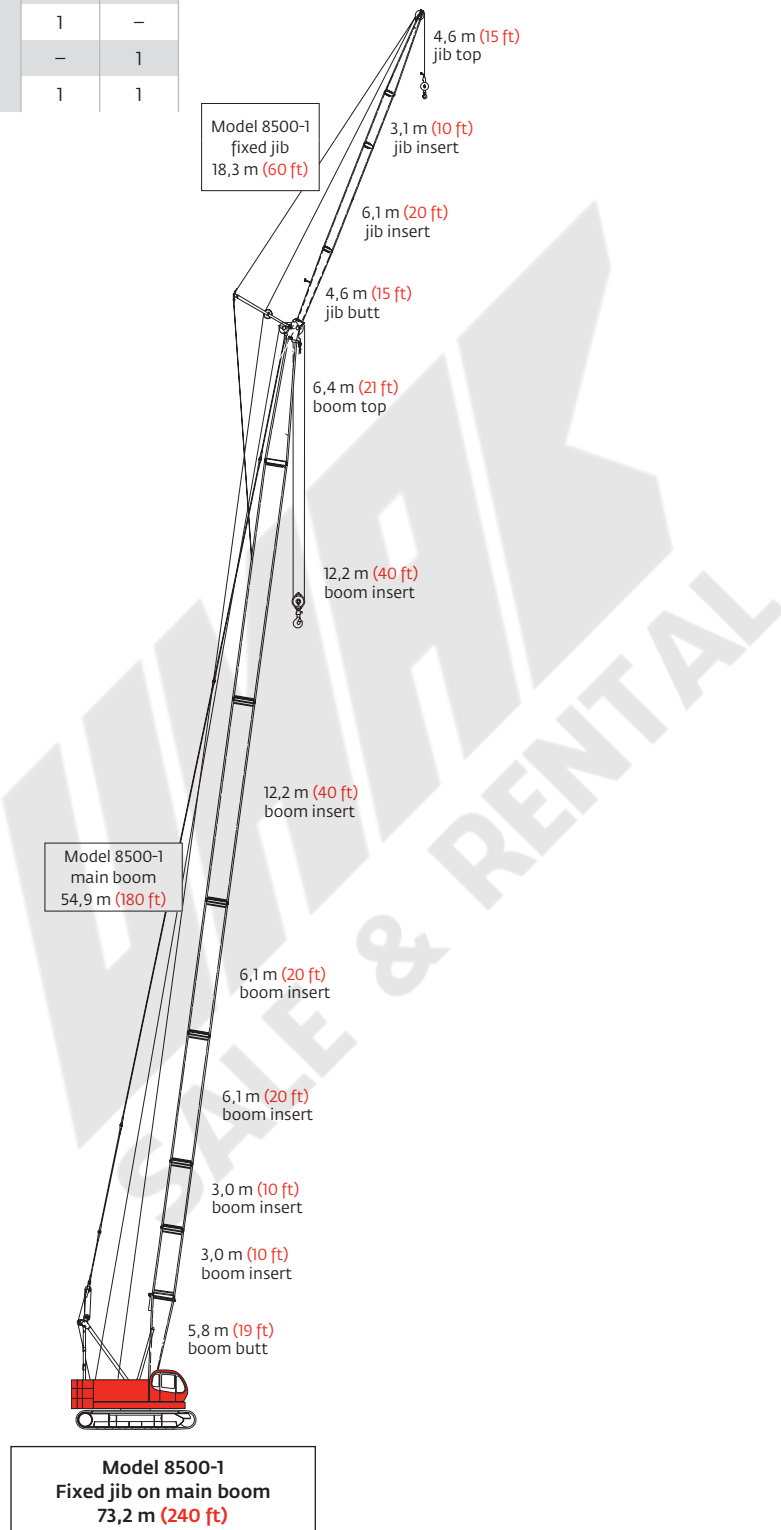

**Model 8500-1
Fixed jib on main boom
73,2 m (240 ft)**

Heavy-lift boom range diagram

No. 8500-1 main boom

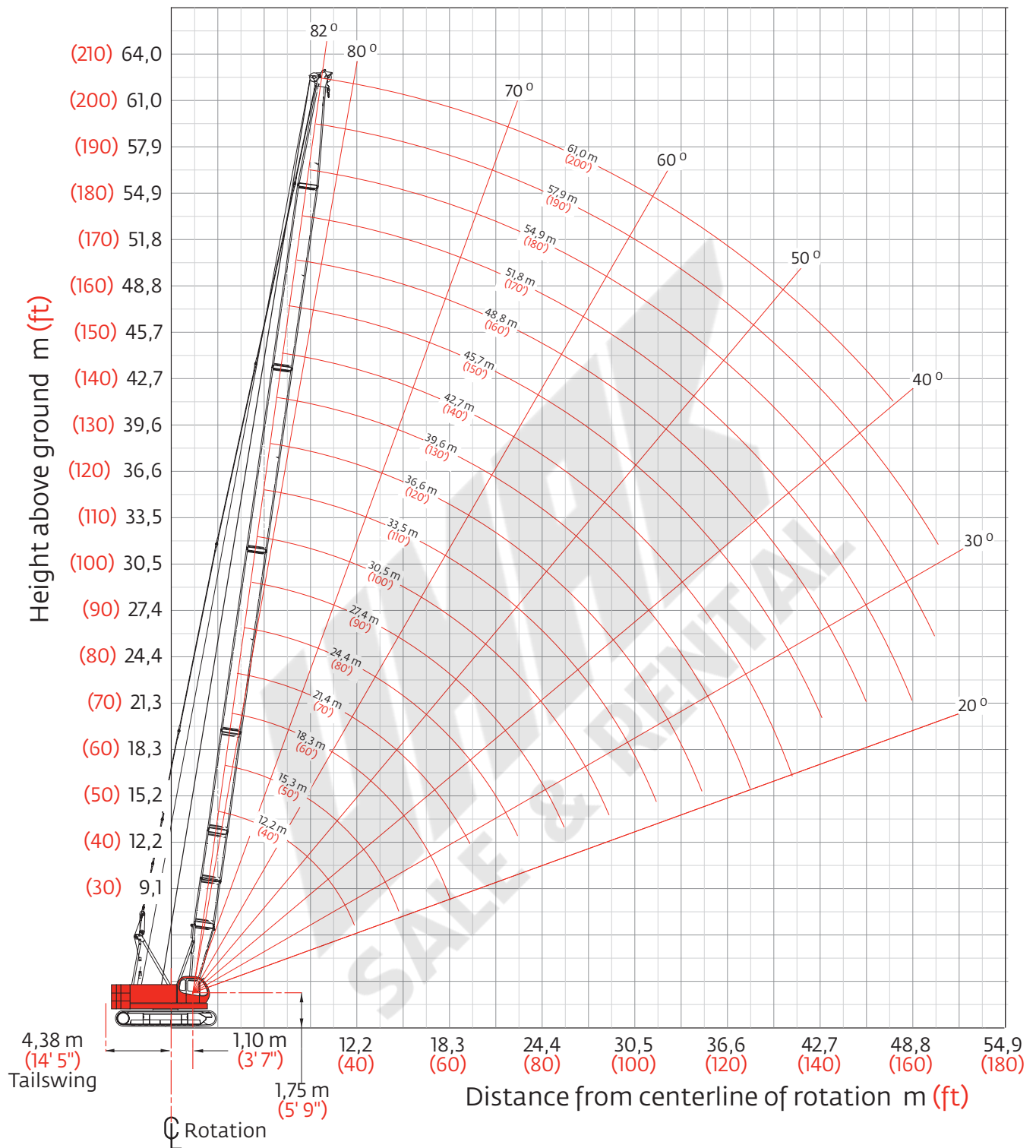

Heavy-lift boom load charts

Model 8500-1 liftcrane boom capacities - 8500-1 main boom

26 120 kg (57,584 lb) crane counterweight
6 500 kg (14,330 lb) carbody counterweight crawler extended

360° Rating kg (lb) x1 000

Boom m (ft)	12,2 (40)	15,2 (50)	18,3 (60)	24,4 (80)	30,5 (100)	36,6 (120)	42,7 (140)	48,8 (160)	54,9 (180)	57,9 (190)	61,0 (200)
Radius											
3,0 (11)	80,0* (170.0)										
3,5 (12)	76,3* (166.6)	— (166.4)*									
4,0 (14)	69,5* (144.2)	69,5* (144.0)	69,3* (143.8)								
4,5 (16)	62,2* (127.1)	62,1* (126.9)	62,0* (126.7)	— (126.3)*							
5,5 (18)	51,2* (113.4)	51,1* (113.2)	51,1* (113.0)	50,9* (112.6)							
6,0 (20)	45,4 (97.5)	45,3 (97.4)	45,2 (97.1)	45,1 (96.9)	44,6* (96.8)						
7,0 (24)	35,9 (74.0)	35,8 (73.8)	35,7 (73.6)	35,6 (73.3)	35,5 (73.1)	34,9* (73.0)	— (61.7)*				
8,0 (28)	29,5 (59.5)	29,4 (59.2)	29,3 (58.9)	29,2 (58.7)	29,1 (58.4)	29,0 (58.3)	27,4* (57.9)	— (44.0)*			
10,0 (34)	21,7 (45.7)	21,6 (45.5)	21,5 (45.2)	21,3 (44.8)	21,2 (44.5)	21,1 (44.3)	21,0 (44.0)	19,2* (42.1)	14,9* (32.6)	13,2* (28.8)	— (25.7)*
12,0 (40)	16,4* (34.8)	17,0 (36.8)	16,8 (36.4)	16,7 (36.0)	16,5 (35.7)	16,4 (35.4)	16,3 (35.1)	16,2 (34.9)	14,1* (31.0)	12,5* (27.5)	11,1* (24.4)
14,0 (45)		13,9* (31.6)	13,8 (31.2)	13,6 (30.8)	13,4 (30.5)	13,3 (30.2)	13,2 (29.9)	13,1 (29.7)	12,9 (29.2)	11,9* (26.4)	10,5* (23.3)
16,0 (55)			11,6 (24.2)	11,4 (23.7)	11,2 (23.3)	11,1 (23.0)	11,0 (22.6)	10,9 (22.4)	10,7 (22.0)	10,7 (22.1)	9,9* (21.3)
22,0 (75)				7,5 (15.9)	7,3 (15.4)	7,1 (15.0)	7,0 (14.6)	6,9 (14.3)	6,7 (13.9)	6,7 (13.9)	6,6 (13.7)
28,0 (95)					5,3 (11.2)	5,1 (10.7)	4,9 (10.2)	4,7 (10.0)	4,5 (9.5)	4,5 (9.5)	4,4 (9.3)
32,0 (105)						4,2 (9.2)	3,9 (8.7)	3,8 (8.5)	3,6 (8.0)	3,6 (8.0)	3,5 (7.8)
34,0 (115)						3,8 (8.1)	3,6 (7.6)	3,4 (7.2)	3,2 (6.7)	3,2 (6.8)	3,1 (6.5)
38,0 (125)							3,0 (6.6)	2,8 (6.2)	2,6 (5.7)	2,6 (5.7)	2,4 (5.4)
40,0 (135)							2,7 (5.9)	2,6 (5.4)	2,3 (4.7)	2,3 (4.8)	2,1 (4.5)
44,0 (145)								2,1 (4.7)	1,8 (4.0)	1,8 (4.0)	1,7 (3.7)
46,0 (155)									1,6 (3.3)	1,6 (3.3)	1,4 (3.0)
52,0 (170)									1,1 (2.6)	— (2.5)	

Meets ANDI B30.5 requirements – Capacities do not exceed 75% of static tipping load.
NOTICE: This capacity chart is for reference only and must not be used for lifting purposes.

For complete chart, refer to www.cranelibrary.com.

Meets ASME B30.5 Requirements - Capacities do not exceed 75% of static tipping load.
NOTICE: This capacity chart is for reference only and must not be used for lifting purposes.

Fixed jib range diagram

No. 8500-1 fixed jib on main boom

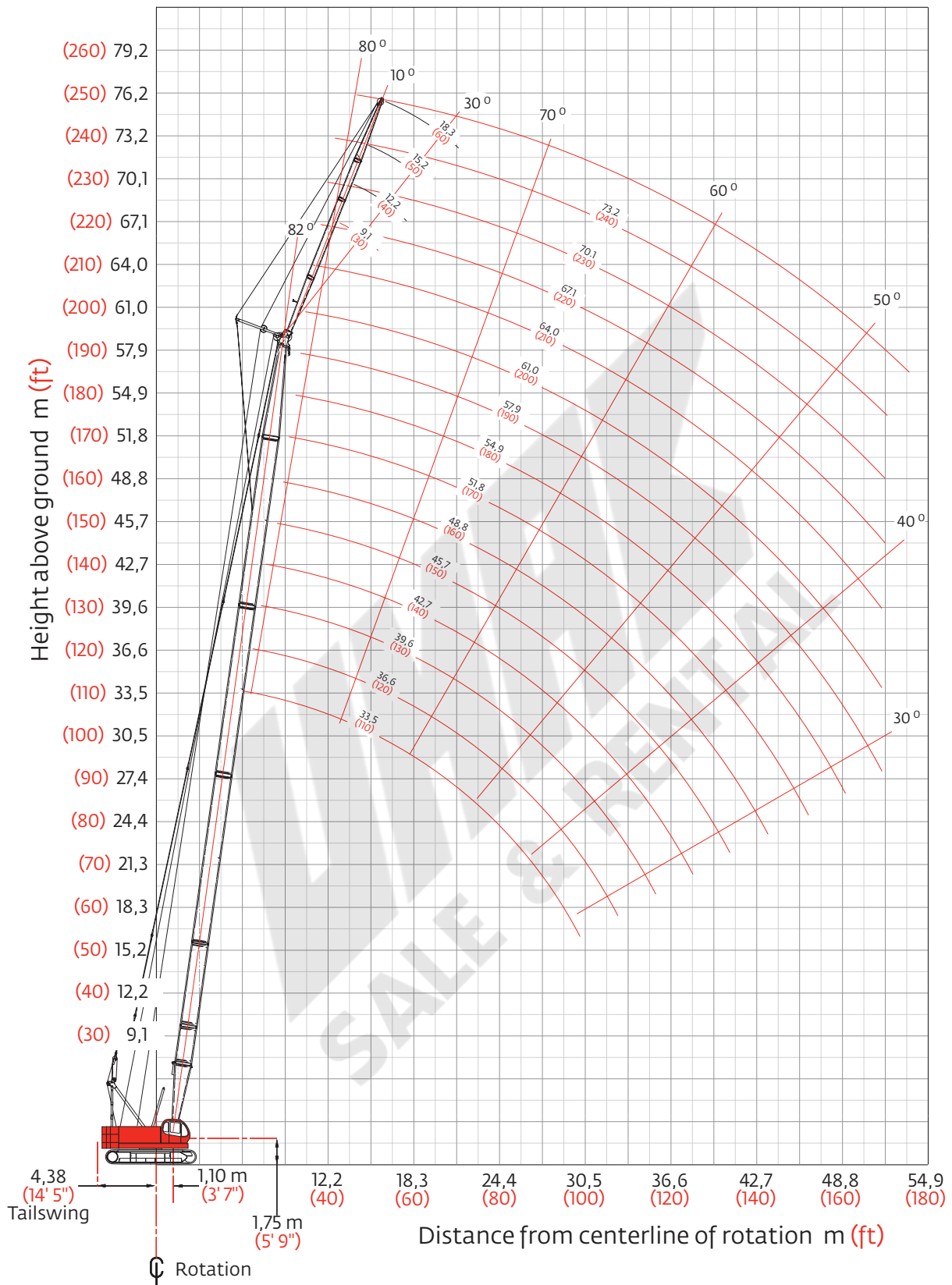

Fixed jib load charts

Model 8500-1 liftcrane jib capacities

No. 8500-1 fixed jib on main boom

26 120 kg (57,584 lb) crane counterweight; 6 500 kg (14,330 lb) carbody counterweight crawler extended

360° Rating

kg (lb) x 1 000

		10° offset					30° offset						
Boom m (ft)		24,4 (80)	30,5 (100)	39,6 (130)	48,8 (160)	54,9 (180)	Boom m (ft)		24,4 (80)	30,5 (100)	39,6 (130)	48,8 (160)	54,9 (180)
jib 9,1 m (30 ft)	Radius												
	10,0 (30)	10,8* (24.0)	10,8* (—)	10,8* (—)			10,0 (30)						
	12,0 (40)	10,8* (24.0)	10,8* (24.0)	10,8* (24.0)			12,0 (40)	9,0* (19.7)					
	14,0 (50)	10,8* (24.0)	10,8* (24.0)	10,8* (24.0)	10,8* (24.0)	8,9* (19.7)	14,0 (50)	8,3* (17.6)	8,7* (18.5)	— (19.6)			
	18,0 (60)	9,8 (21.3)	9,6 (20.8)	9,4 (20.3)	9,1 (19.7)	8,5* (18.7)	18,0 (60)	7,3* (15.9)	7,7* (16.9)	8,2* (18.0)	8,6* (18.9)	8,4* (18.5)	
	24,0 (80)	6,7 (14.4)	6,4 (13.9)	6,2 (13.3)	5,9 (12.7)	5,7 (12.3)	24,0 (80)	6,2* (13.7)	6,5* (14.3)	6,4 (13.7)	6,1 (13.2)	6,0 (12.9)	
	30,0 (100)	4,9 (10.6)	4,6 (10.0)	4,3 (9.4)	4,1 (8.8)	3,9 (8.3)	30,0 (100)			4,5 (9.7)	4,2 (9.1)	4,1 (8.7)	
	36,0 (120)		3,6 (—)	3,2 (6.9)	2,9 (6.2)	2,7 (5.8)	36,0 (120)				3,0 (6.5)	2,8 (6.1)	
	42,0 (140)			2,3 (5.2)	2,0 (4.4)	1,8 (3.7)	42,0 (140)						1,9 (4.0)
	44,0 (150)				1,8 (3.6)	1,5 (2.9)	44,0 (150)						1,6 (—)
48,0 (160)				1,3 (2.9)	1,1 (—)	48,0 (160)							
52,0 (170)						52,0 (170)							
jib 12,2 m (40 ft)	Radius												
	10,0 (30)	10,8* (—)	10,8* (—)				10,0 (30)						
	12,0 (40)	10,8* (24.0)	10,8* (24.0)	10,8* (—)			12,0 (40)	6,9* (—)					
	14,0 (50)	10,7* (22.1)	10,8* (24.0)	10,8* (24.0)	10,3* (22.8)		14,0 (50)	6,8* (14.4)	6,8* (15.1)				
	18,0 (60)	8,6* (18.8)	9,6* (20.9)	9,5 (20.5)	9,2* (20.3)	8,1* (17.8)	18,0 (60)	5,9* (12.9)	6,2* (13.6)	6,6* (14.5)	6,8* (15.1)		
	24,0 (80)	6,6* (14.5)	6,5 (14.1)	6,2 (13.5)	6,0 (12.9)	5,8 (12.5)	24,0 (80)	5,0* (10.9)	5,3* (11.6)	5,7* (12.5)	6,0* (13.2)	6,2* (13.5)	
	30,0 (100)	4,9 (10.7)	4,7 (10.2)	4,4 (9.5)	4,1 (8.9)	4,0 (8.5)	30,0 (100)		4,7* (10.3)	4,6 (10.0)	4,5 (9.6)	4,3 (9.3)	
	36,0 (120)		3,5 (7.6)	3,2 (7.0)	2,9 (6.4)	2,8 (5.9)	36,0 (120)			3,4 (7.4)	3,2 (6.9)	3,0 (6.5)	
	42,0 (140)			2,4 (5.2)	2,1 (4.5)	1,8 (3.9)	42,0 (140)				2,3 (5.0)	2,1 (4.5)	
	44,0 (150)			2,2 (4.6)	1,9 (3.7)	1,6 (3.1)	44,0 (150)					1,8 (3.6)	
48,0 (160)				1,4 (3.0)	1,2 (—)	48,0 (160)							
52,0 (170)						52,0 (170)							

For complete chart, refer to www.cranelibrary.com.

Meets ASME B30.5 Requirements - Capacities do not exceed 75% of static tipping load.
 NOTICE: This capacity chart is for reference only and must not be used for lifting purposes.

Fixed jib load charts

Model 8500-1 liftcrane jib capacities

No. 8500-1 fixed jib on main boom

26 120 kg (57,584 lb) crane counterweight; 6 500 kg (14,330 lb) carbody counterweight crawler extended

360° Rating

kg (lb) x 1 000

		10° offset					30° offset						
Boom m (ft)		24,4 (80)	30,5 (100)	39,6 (130)	48,8 (160)	54,9 (180)	Boom m (ft)		24,4 (80)	30,5 (100)	39,6 (130)	48,8 (160)	54,9 (180)
Radius													
jib 15,2 m (50 ft)	10,0 (30)	9,0* (20.0)					10,0 (30)						
	12,0 (40)	9,0* (20.0)	9,0* (20.0)	9,0* (—)			12,0 (40)						
	14,0 (50)	8,9* (18.5)	9,0* (20.0)	9,0* (20.0)			14,0 (50)						
	18,0 (60)	7,2* (15.6)	7,9* (17.2)	8,8* (19.3)	8,7* (19.2)	7,4* (17.0)	18,0 (60)	4,8* (10.4)	5,0* (10.9)	5,2* (11.4)	5,1* (—)		
	24,0 (80)	5,5* (12.0)	6,1* (13.3)	6,3 (13.6)	6,1 (13.1)	5,9* (12.7)	24,0 (80)	4,0* (8.7)	4,2* (9.2)	4,5* (9.8)	4,7* (10.3)	4,8* (10.6)	
	30,0 (100)	4,5* (9.7)	4,7 (10.3)	4,5 (9.7)	4,2 (9.1)	4,0 (8.7)	30,0 (100)	3,4* (7.6)	3,7* (8.0)	3,9* (8.7)	4,2* (9.2)	4,3* (9.5)	
	36,0 (120)	3,9* (8.6)	3,6 (7.7)	3,3 (7.1)	3,0 (6.5)	2,8 (6.0)	36,0 (120)		3,5* (7.6)	3,3 (7.1)	3,1 (6.8)		
	42,0 (140)		2,9 (—)	2,5 (5.7)	2,0 (4.6)	1,9 (4.0)	42,0 (140)			2,4 (5.2)	2,2 (4.8)		
	44,0 (150)			2,2 (4.6)	1,9 (3.1)	1,6 (3.2)	44,0 (150)				2,2 (—)	2,0 (3.9)	
	48,0 (160)			1,9 (4.0)	1,4 (—)	1,2 (—)	48,0 (160)					1,5 (3.1)	
52,0 (170)						52,0 (170)							
Boom m (ft)		24,4 (80)	30,5 (100)	39,6 (130)	48,8 (160)	54,9 (180)	Boom m (ft)		24,4 (80)	30,5 (100)	39,6 (130)	48,8 (160)	54,9 (180)
Radius													
jib 18,3 m (60 ft)	10,0 (30)						10,0 (30)						
	12,0 (40)	8,1* (18.0)	8,1* (—)				12,0 (40)						
	14,0 (50)	8,0* (16.3)	8,1* (17.6)	8,1* (18.0)			14,0 (50)						
	18,0 (60)	6,3* (13.7)	6,9* (15.0)	7,6* (16.7)	8,0* (17.8)	6,8* (15.0)	18,0 (60)	4,0* (8.9)	3,9* (—)				
	24,0 (80)	4,8* (10.4)	5,3* (11.5)	6,0* (13.0)	6,1 (13.2)	5,9* (12.8)	24,0 (80)	3,3* (7.3)	3,5* (7.7)	3,7* (8.1)	3,9* (8.5)	3,9* (8.7)	
	30,0 (100)	3,8* (8.3)	4,3* (9.3)	4,5 (9.7)	4,2 (9.1)	4,1 (8.7)	30,0 (100)	2,8* (6.2)	3,0* (6.6)	3,2* (7.1)	3,4* (7.5)	3,5* (7.7)	
	36,0 (120)	3,2* (7.0)	3,6* (7.8)	3,3 (7.1)	3,0 (6.5)	2,8 (6.1)	36,0 (120)		2,7* (5.9)	2,9* (6.3)	3,1* (6.7)	3,2 (7.0)	
	42,0 (140)		2,8 (6.0)	2,5 (5.4)	2,2 (4.7)	1,9 (4.1)	42,0 (140)			2,6 (5.8)	2,5 (5.3)	2,3 (5.0)	
	44,0 (150)		2,6 (—)	2,3 (4.7)	1,9 (3.9)	1,7 (3.3)	44,0 (150)				2,2 (4.5)	2,1 (4.1)	
	48,0 (160)			1,9 (4.0)	1,5 (3.1)	1,2 (2.5)	48,0 (160)				1,8 (3.8)	1,6 (3.3)	
52,0 (170)			— (3.4)	1,1 (2.5)		52,0 (170)					1,1 (2.6)		

For complete chart, refer to www.cranelibrary.com.

Meets ASME B30.5 Requirements - Capacities do not exceed 75% of static tipping load.
NOTICE: This capacity chart is for reference only and must not be used for lifting purposes.

Clamshell

Boom:

Welded lattice construction using tubular, high-tensile steel chords with pin connections between sections.

Basic boom length: 12,2 m (40 ft)

Max. boom length: 21,3 m (70 ft)

Limit on clamshell bucket weight: 2 100 kg (4,600 lb)

Maximum component chart

Boom length m (ft)	Boom arrangement
12,2 (40)	Base-Tip
15,2 (50)	Base-A-Tip
18,3 (60)	Base-A-A-Tip, Base-B-Tip
21,3 (70)	Base-A-B-Tip

Base = 6,10 m (20 ft)

Insert: A = 3,1 m (10 ft)

B = 6,1 m (20 ft)

Tip = 6,10 m (20 ft)

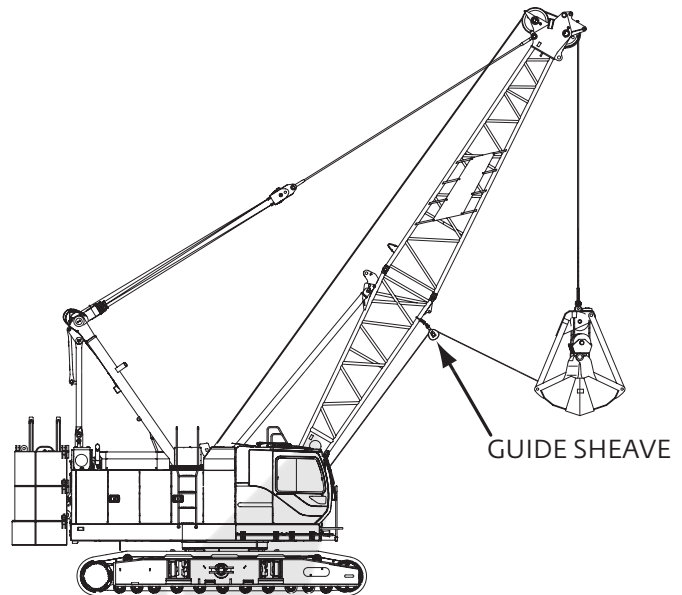

1. Figures represent maximum allowable capacity, and assume level ground and ideal working conditions.
2. Capacities are calculated at 66% of the minimum tipping loads.
3. Capacities are maximum recommended by PCSA Standard #4. Allowances must be made by the user for such unfavorable conditions as a soft or uneven supporting surface, rapid cycle operations, or bucket suction.
4. The combined weight of the bucket and load must not exceed these capacities.
5. Boom length for clamshell operation should not exceed 21,3 m (70 ft).

Clamshell Capacities

17,7 t (19.5 USt) counterweight
(three upper counterweights, crawlers extended)

kg (lb) x 1 000

Boom m (ft)	12,2 (40)	15,2 (50)	18,3 (60)	21,3 (70)
Radius				
6,7 (22)	7,2* (16.0)			
7,9 (26)	7,2* (16.0)	7,2* (16.0)		
9,1 (30)	7,2* (16.0)	7,2* (16.0)	7,2* (16.0)	
10,9 (36)	7,2* (16.0)	7,2* (16.0)	7,2* (16.0)	7,2* (16.0)
12,2 (40)	7,2* (16.0)	7,2* (16.0)	7,2* (16.0)	7,2* (16.0)
14,0 (46)		6,9* (16.0)	7,0* (16.0)	7,0* (15.6)
15,2 (50)			6,1* (14.5)	6,1* (14.3)
17,1 (56)			5,1 (12.3)	5,1* (12.3)
18,7 (60)				5,1* (11.2)
20,1 (66)				4,4* (9.7)

Manitowoc Crane Care

Crane Care is Manitowoc's comprehensive service and support program. It includes classroom and on-site training, prompt parts availability, expert field service, technical support and documentation.

That's commitment you won't find anywhere else.

That's Crane Care.

Service training

Manitowoc specialists work with you in our training centers and in the field to make sure you know how to get maximum performance, reliability and life from your cranes.

Manitowoc Cranes Technical Training Centers provide valuable multi-level training, which is available for all models and attachments, in the following format:

- **Intro to Canbus and Canbus 1, 2, 3**
- **Intro to EPIC and EPIC 1, 2, 3**
- **Small Crawler 1**
- **Canbus 1 and 2 assembly, operation and maintenance**
- **EPIC 1 and 2 assembly, operation and maintenance**

Refer to www.manitowoc.com for course descriptions.

Parts availability

Genuine Manitowoc replacement parts are accessible through your distributor 24 hours a day, 7 days a week, 365 days a year.

Service interval kits
200 hour kit
1,000 hour kit
2,000 hour kit
Hydraulic test kit
U.S. standard tools kit

Field service

Factory-trained service experts are always ready to help maintain your crane's peak performance.

For a worldwide listing of dealer locations, please consult our website at: www.manitowoc.com

Technical support

Manitowoc's dealer network and factory personnel are available 24 hours a day, 7 days a week, 365 days a year to answer your technical questions and more, with the help of computerized programs that simplify crane selection, lift planning, and ground-bearing calculations.

For a worldwide listing of dealer locations, please consult our website at: www.manitowoc.com

Technical documentation

Manitowoc has the industry's most extensive documentation; available in major languages and formats that include print, videotape, and DVD/CD.

Additional copies available through your Authorized Manitowoc Distributor.

- Crane operator's manual
- Crane parts manual
- Crane capacity manual
- Crane vendor manual
- Crane service manual
- Luffing jib operator's/parts manual
- Capacity chart manual - attachments

Available from your Authorized Manitowoc Cranes Distributor, these videos are available in NTSC, PAL, SECAM, and DVD formats.

- Your Capacity Chart Video
- Respect the Limits Video
- Crane Safety Video
- Boom Inspection/Repair Video

Crane Care Package

Manitowoc has assembled all of the available literature, CD's and videos listed above plus several Manitowoc premiums into one complete Crane Care Package, which is supplied to the owner of each new crane.



Manitowoc Cranes

Regional headquarters

Americas

Manitowoc, Wisconsin, USA
Tel: +1 920 684 6621
Fax: +1 920 683 6277

Shady Grove, Pennsylvania, USA
Tel: +1 717 597 8121
Fax: +1 717 597 4062

Europe, Middle East, Africa

Ecully, France
Tel: +33 (0)4 72 18 20 20
Fax: +33 (0)4 72 18 20 00

China

Shanghai, China
Tel: +86 21 6457 0066
Fax: +86 21 6457 4955

Greater Asia-Pacific

Singapore
Tel: +65 6264 1188
Fax: +65 6862 4040

Regional offices

Americas

Brazil
Alphaville
Mexico
Monterrey
Chile
Santiago

Europe, Middle East, Africa

France
Baudemont
Cergy
Decines
Germany
Langenfeld
Italy
Lainate
Netherlands
Breda
Poland
Warsaw
Portugal
Baltar
Russia
Moscow
South Africa
Johannesburg
U.A.E.
Dubai
U.K.
Buckingham

China

Beijing
Chengdu
Guangzhou
Xian

Greater Asia-Pacific

Australia
Brisbane
Melbourne
Sydney
India
Chennai
Delhi
Hyderabad
Pune
Korea
Seoul
Philippines
Makati City
Singapore

Factories

Brazil
Passo Fundo
China
TaiAn
Zhangjiagang
France
Charlieu
Moulins
Germany
Wilhelmshaven
India
Pune
Italy
Niella Tanaro
Portugal
Baltar
Fânzeres
Slovakia
Saris
USA
Manitowoc
Port Washington
Shady Grove

This document is non-contractual. Constant improvement and engineering progress make it necessary that we reserve the right to make specification, equipment, and price changes without notice. Illustrations shown may include optional equipment and accessories and may not include all standard equipment.