

model 777T

product guide

features

- 181 mton (200 ton) capacity
- 698 mton-m (5,050 kips) Maximum Load Moment
- 82,3 m (270') Heavy-Lift Boom
- 90,8 m (298') Long-Reach Boom
- 91,4 m (300') Fixed Jib on Heavy-Lift Boom
- 96,9 m (318') Fixed Jib on Long-Reach Boom
- 106,7 m (350') Luffing Jib on Heavy-Lift Boom
- 125,0 m (410') Fixed Jib on Luffing Jib on Heavy-Lift Boom
- 195 kW (260 HP) engine upperworks
- 373 kW (500 HP) engine carrier
- EPIC® controls
- 135 m/min (442 fpm) line speed standard
- 177 m/min (581 fpm) line speed optional
- 131 kN (29,500 lb) line pull standard
- Hydraulic-cylinder Boom Hoist for maximum performance with minimum maintenance
- Fast, efficient self-assembly
- 10x6 Carrier travels with upperworks in place. 96,6 kph (60 mph) travel speed.
- Manitowoc CraneCARE®

contents

Specifications	3
Outline Dimensions	7
Transport / Assembly	13
Performance Data	16
Boom Combinations	24
Main Boom Range / Load Charts	27
Long Reach Range / Load Charts	31
Fixed Jib Range / Load Charts	33
Luffing Jib Range / Load Charts	39
Luffing Jib on Luffing Jib Range / Load Charts	43
CraneCARE™	47

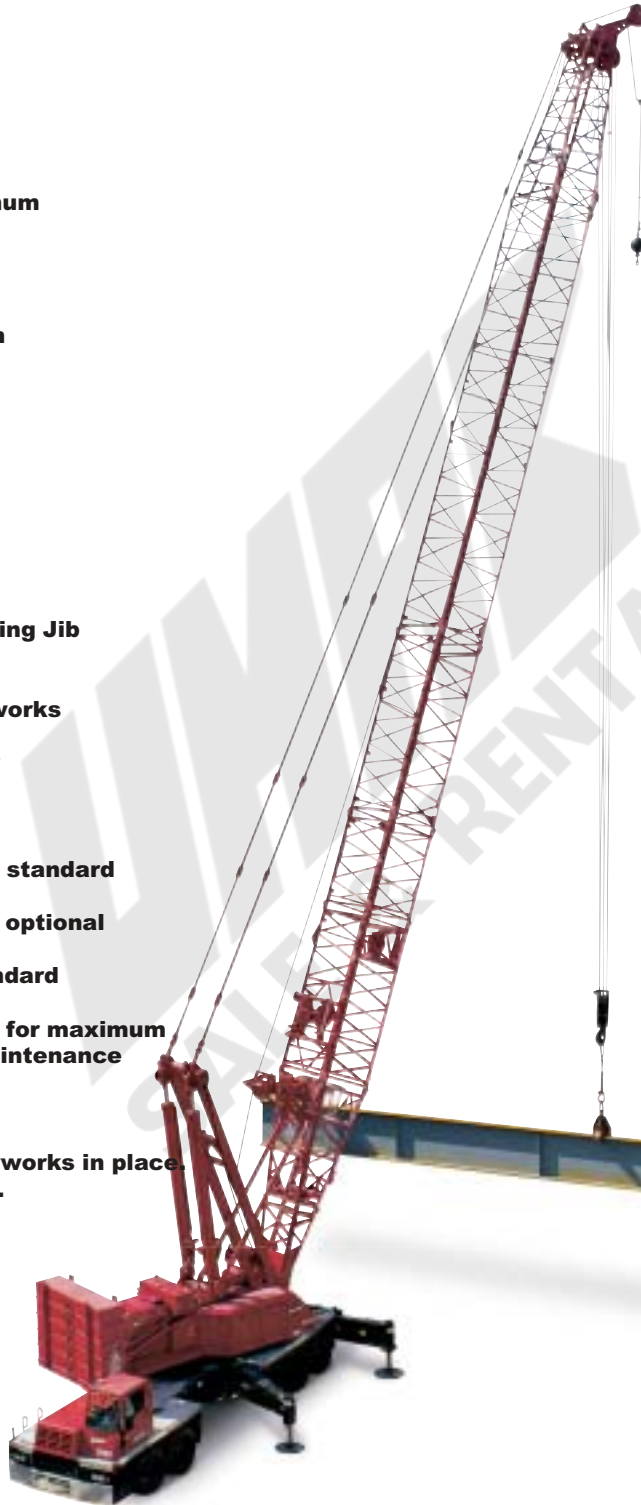

	Specifications	Outline Dimensions/Weights	Wire Rope Lengths	Wire Rope Specifications	Boom Raising	Boom Combinations	Range Diagram/Capacity Charts
No. 777T Basic Crane	3-6	7-8					
Engine(s)	3						
Hydraulic System	3						
Drums & Laggings	3, 21-22						
Boom Hoist	4						
Swing System	4						
Mast	4						
Counterweights	4	9					
Operator's Cab	4						
Carrier, Axles, Outriggers	4	9					
Roading options		13					
Optional Equipment							
Boom point	5	12					
Hook block/weight ball	5	12					
Miscellaneous	5-6	12					
Working Weights	23						
Transport/Assembly	13-15						
CraneCARE SM	48-49						
No. 78 Boom							
Heavy-Lift No. 78T	5	9-10	16	20	22	24	27-30
Long-Reach No. 78T	5	10	17	20	23	25	31-32
Heavy-Lift No. 78T with No. 134 Fixed Jib	5	11	16	20	23	24	33-35
Long-Reach No. 78T with No. 134 Fixed Jib			17	20	23	25	36-38
Heavy-Lift No. 78T with No. 139 Luffing Jib	5	11-12	19	20	23	26	39-42
Heavy-Lift No. 78T with No. 139 Luffing Jib with No. 138 Fixed Jib	5	12	19	20	23	26	43-46

SALE & RENTAL

Upperworks

Engine

Cummins Model 6CTA 8.3 – C260 diesel, 6 cylinder, 195 kW (260 BHP) @ 2200 governed RPM.

Optional: Caterpillar Model C-9 diesel, 6 cylinder, 253 kW (340 BHP) @ 2100 governed RPM.

Includes engine block heater (120 V), ether starting aid, manually operated disconnect clutch for cold weather starting, high silencing muffler, hydraulic oil cooler, radiator and fan.

Multiple hydraulic pump drive transmission provides independent power for all machine functions.

Two 12 volt maintenance-free, Group 8D batteries, 1400 CCA at -18°C (0° F), 24 volt starting and 120 amp alternator.

One 469 l (124 gal) capacity diesel fuel tank, mounted on rear of upperworks, with level indicator in operator's cab.

Controls

Modulating electronic-over-hydraulic controls provide infinite speed response directly proportional to control lever movement. Controls include Manitowoc's exclusive EPIC® Electronically Processed Independent Control system providing microprocessor driven control logic, pump control, on-board diagnostics, and service information.

Block-up limit control is standard for hoist and auxiliary lines.

Integrated Load Moment Indicator system (LMI) is standard for main boom. "Function cut-out" or "warning only" operation is selected via a keyed switch on the LMI console. Includes travel and swing alarms.

Optional: Upper boom point assembly with LMI.

Optional: Anemometer (wind indicator).

Hydraulic System

Four high-pressure piston pumps are driven through a multi-hydraulic pump transmission. These six pumps provide independent "closed loop" hydraulic power for front drum, rear drum, boom hoist system, swing system, and both left and right crawler operation.

System	kg/cm ² (psi)	lpm (gpm)
Front Drum	422 (6,000)	300 (79)
Rear Drum	422 (6,000)	300 (79)
Boom Hoist	422 (6,000)	300 (79)
Swing System	386 (5,500)	225 (59)
Auxiliary Pump*	422 (6,000)	390 (102)

*Optional pump powers auxiliary drum on liftcrane.

Hydraulic reservoir capacity is 469 l (124 gal) and is equipped with breather, dipstick, clean out access, and internal diffuser.

Each function is equipped with relief valves to protect the hydraulic circuit from overload or shock.

Replaceable, spin on ten micron (absolute) full flow line filter is furnished in the hydraulic circuit. All oil is filtered prior to return to the hydraulic reservoir.

Hydraulic system also includes pump transmission disconnect clutch & hydraulic oil cooler.

Drums

Two equal width winches 770 mm (30-1/8") wide and 495 mm (19-1/2") diameter are driven by independent variable displacement axial piston hydraulic motors through planetary reduction mounted on separate front and rear shafts with anti-friction bearings. Drums are grooved for 25,4 mm (1") rope.

Powered hoisting/lowering operation is standard with automatic (spring applied, hydraulically released) multi-disc brakes, and drum rotation indicators.

Optional: Free-fall operation for front and/or rear drum(s). External contracting band brake mounted on drum manually applied by foot pedal with locking latch in operator's cab. Operator may select free-fall or powered lowering mode using a selector switch.

Optional: High line speed drum 207m/min (581 fpm) can be ordered in place of standard front or rear drum.

Optional: Auxiliary (third) hydraulic powered drum rated at 89,0 kN (20,000 lb) line pull mounted in boom butt. Includes third drum control system.

Optional: Auxiliary drum preparation includes electric wiring, controls, hydraulic pump and plumbing.

Optional: Bolt-on liftcrane/clamshell laggings.

Optional: Wire rope for various applications.

specifications

4

Mast

Moving mast is 7,9 m (26') long and connects the boom hoist cylinders to the boom-support pendants.

Spring cushioned boom stop and automatic boom stop standard.

Boom Hoist

Independent boom hoist is provided by two double-acting hydraulic cylinders connected to the mast. Boom hoist provides full range of boom angles from horizontal to 88 degrees, with or without load.

Boom hoist speed: raise 82,3 m (270') full main boom from 0° - 82° in 1 minute, 40 seconds.

Swing System

High strength fabricated steel rotating bed is mounted on 2,15 m (84-1/2") diameter turntable single-row ball bearing.

Independent swing powered by a fixed displacement hydraulic motor coupled to a planetary gearbox with internal brake. 360° positive swing lock.

Swing system maximum speed: 2.7 rpm.

Counterweight

QTY.	ITEM	UNIT WEIGHT		TOTAL WEIGHT	
		kg	lb	kg	lb
1	Upper Tray	4 717	10,400	4 717	10,400
5	Upper Box	7 699	16,975	38 495	84,875
UPPER TOTAL		47 628	95,400		
1	Front Bumper Adapter	3 649	8,045	3 649	8,045
1	Front Box	7 699	16,975	7 699	16,975
FRONT BUMPER TOTAL		11 340	25,000		
COMBINED TOTAL		54 613	120,400		

Includes connecting pins, brackets, and stops.

Operator's Cab

Fully enclosed and insulated steel module located at the left front corner of rotating bed. Module is equipped with sliding door, large safety glass windows on all sides and roof. Signal horn, cab space heater, front and roof windshield wipers, dome light, sun visor and shade, fire extinguisher and air circulating fan are standard.

- ▶ Optional: Air conditioner.
- ▶ Optional: Nylon protective window covers.

Truck Chassis

Carrier

10 x 6 carrier has an overall length of 12,2 m (40' 0") and is 3,35 m (11' 0") wide with the rear outrigger assembly removed. The carrier is powered by a Detroit Diesel Series 60 diesel engine rated at 373 kW (500 HP) at 2100 RPM and an Allison HD4560 automatic transmission (6 speeds forward, 1 reverse) with a four speed auxiliary transmission. A Jacob's "Jake Brake" engine retarder is included as standard on the engine. Carrier fuel tank of 100 gallon capacity is provided as standard.

Axles

Axles 1 and 2 are steerable, single wheel type, 2 972 mm (117") track and mounted on a spring-over-walking beam suspension. Axles 3, 4, and 5 are planetary, dual wheel type, 2 540 mm (100") track and mounted on a walking beam suspension.

Outriggers

The rear outriggers are bypassing tunnel out-and-down type, FACTTM connected to the rear of the carrier, and hydraulically extended and retracted. The front outriggers are radial type and are FACT connected to the mid-section of the carrier. The front outriggers are hinged to swing radially and can be either removed or swung forward hydraulically to provide and 3,35 m (11' 0") travel width. All outriggers are equipped with hydraulic jacks with check valves and 91cm (36") diameter composite outrigger pads. Front hydraulic jack assembly is mounted on front of carrier to support carrier engine and driver's cab weight during crane operation, and is equipped with 64cm (24") diameter. composite pad. Outrigger controls are located on each side of carrier and in carrier cab as standard equipment.

Chassis Operator's Cab

The large one-man cab is an insulated module with adequate ventilation to provide excellent driver comfort and visibility. Left side window (in door) rolls down. Right side window slides open. Cab accessories include normal vehicle accessories, instrumentation, and an air-ride seat.

Attachments

No. 78T Heavy-Lift Main Boom

The liftcrane is equipped with a 18,3 m (60') No. 78T basic heavy-lift angle chord boom consisting of a 6,9 m (22' 6") No. 78T two-piece butt, 5,3 m (17' 6") No. 78T basic insert and 6,1 m (20') No. 78T quick reave top with six 76,2 cm (30") diameter roller bearing sheaves on one shaft. Includes rope guides, boom angle indicator, and 13,6 mton (15 ton) swivel hook and weight ball. The No. 78T boom utilizes steel suspension straps and Manitowoc's patented, exclusive FACT™ connection system. The FACT connection system consists of two vertical pins, two horizontal connection pins and alignment pads for each boom connection location.

Luffing jib preparation included as standard.

- Optional: 3,05 m (10'), 6,1 m (20'), and 12,2 m (40') No. 78T boom inserts with pendant rigging and FACT™ connection system.
- Optional: No. 78T detachable upper boom point with one 76,2 cm (30") diameter tapered roller bearing steel sheave grooved for 1-1/8" rope with rope guard for liftcrane.

No. 78T Long-Reach Boom

The long-reach top option requires a 15,2 m (50') transition insert and 14,6 m (48') tapered top with three 68,6 cm (27") straight roller bearing sheaves and wire rope guide. Includes LMI hardware. Optional No. 78T inserts can be added for long-reach top lengths from 42,1 m (138') to 90,8 m (298'). Intermediate strut suspension parts are required for boom lengths of 51,2 m (168') and greater.

No. 134 Fixed Jib

- Optional: No. 134 basic fixed jib 9,1 m (30') length consisting of 4,6 m (15') jib butt and 4,6 m (15') jib top with 3,7 m (12') jib strut, pendants and backstay. Includes LMI hardware.
- Optional: No. 134 fixed jib inserts 3,05 m (10') and 6,1 m (20') with pendants.

Utilize fixed jib inserts in combination with the No. 134 basic fixed jib for total lengths up to 24,4 m (80').

Note: Jib lengths greater than 18,3 m (60') require the use of at least one 6,1 m (20') No. 134 fixed jib insert.

No. 139 Luffing Jib

- Optional: 21,3 m (70') basic No. 139 luffing jib assembly with LMI hardware consisting of 8,2 m (27') butt, 6,1 m (20') insert and 7,0 m (23') top with two 68,6 cm (27") straight roller bearing sheaves, pin connected jib sections, pendant rigging, fixed strut, jib strut, backstay straps, jib point wheel, 26 mm or (1") luffing jib hoist line, and 54 cm (21-1/4") grooved lagging for rear luffing drum.
- Optional: 3,05 m (10'), 6,1 m (20'), and 12,2 m (40') No. 139 inserts with steel boom suspension straps.

No. 138 Fixed Jib

- Optional: No. 138 basic fixed jib 9,1 m (30') length consisting of 4,6 m (15') jib butt and 4,6 m (15') jib top with 5,4 m (17' 9-7/16") jib strut, pendants and backstay. For use with No. 139 Luffing Jib.
- Optional: No. 138 fixed jib inserts 3,0 m (10') and 6,1 m (20') with pendants.

Utilize fixed jib inserts in combination with the No. 138 basic fixed jib for total lengths up to 18,3 m (60').

Optional Equipment

- Optional: Blocks and Hooks, each with 762 mm (30") roller-bearing sheaves for 26 mm or (1") wire rope, a roller-bearing swivel hook, a hook latch, and a swivel lock.
- 13,6 mton (15 ton) swivel hook and weight ball.
- 54,4 mton (60 ton) hook block with two 76,2 cm (30") sheaves.
- 90,7 mton (100 ton) hook block with three 76,2 cm (30") sheaves .
- 160 mton (175 ton) hook block with six 76,2 cm (30") sheaves.
- Optional: Wire rope for various applications.
- Optional: Rolling outrigger attachments for rear out-and-down outriggers.
- Optional: Equipment and testing for special code compliance.
- Optional: Hydraulic Test Kit: required to properly analyze the performance of the EPIC® control system.

specifications

6

Optional: Service Interval Kits: for the regularly scheduled maintenance of general crane operations.

Optional: Lighting Packages: consult dealer for available options.

Optional: Special paint colors other than Manitowoc standard red and black.

Optional: Custom vinyl decals of customer name and/or logo from artwork supplied by customer.

Optional: Export Packaging: basic crane, boom and jib sections.

Optional Application

Optional: For limited clamshell work: guide bars for lower boom point; Rud-O-Matic® No. 1866 spring-powered three-barrel tagline with 76,2 cm (36") diameter wheel; and pressure rollers for the front and rear hoisting drums. Front drum is closing line. Rear drum is holding line. Manitowoc's EPIC® controls can be changed from liftcrane to clamshell mode with the flip of a switch.

outline dimensions

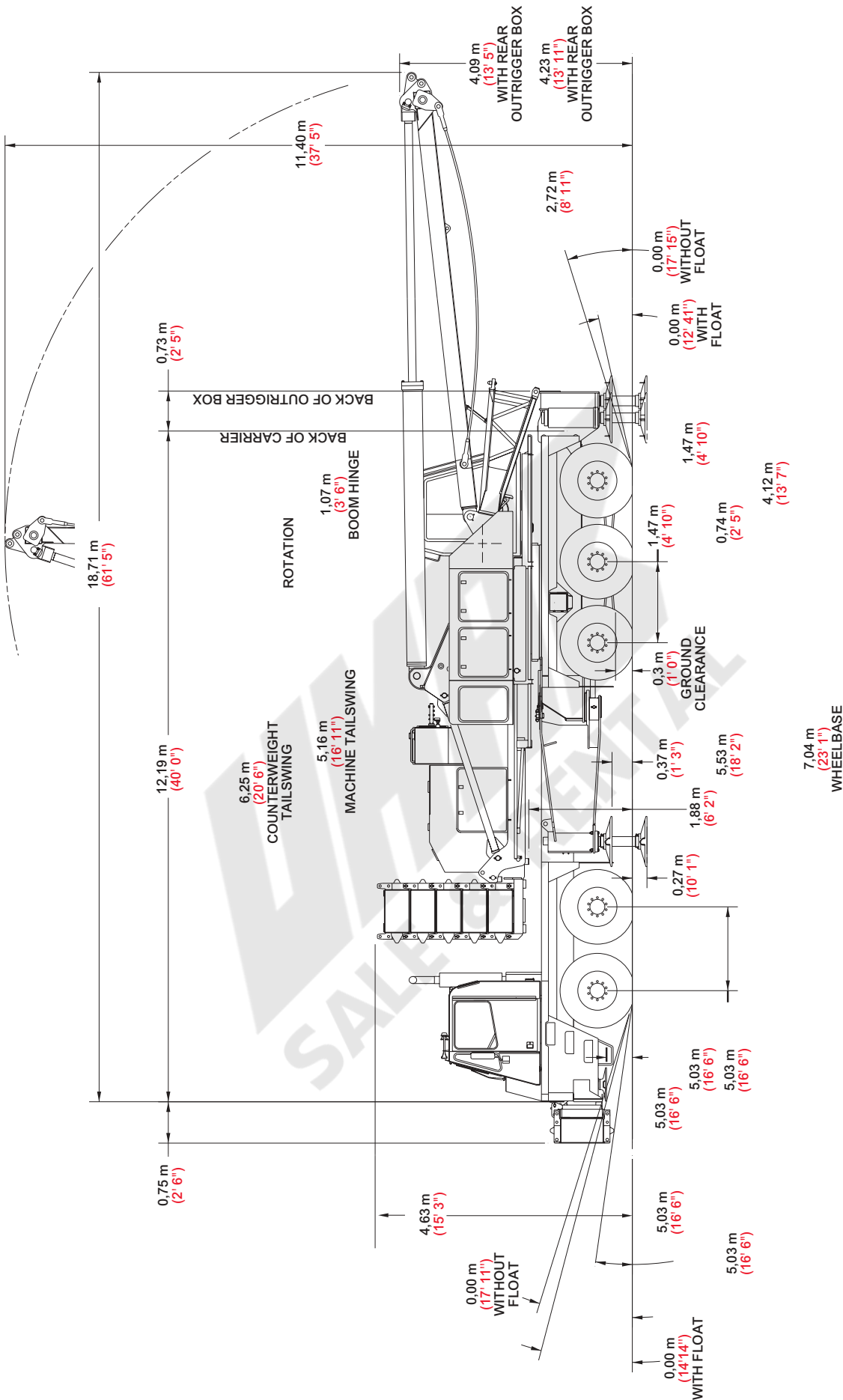

outline dimensions

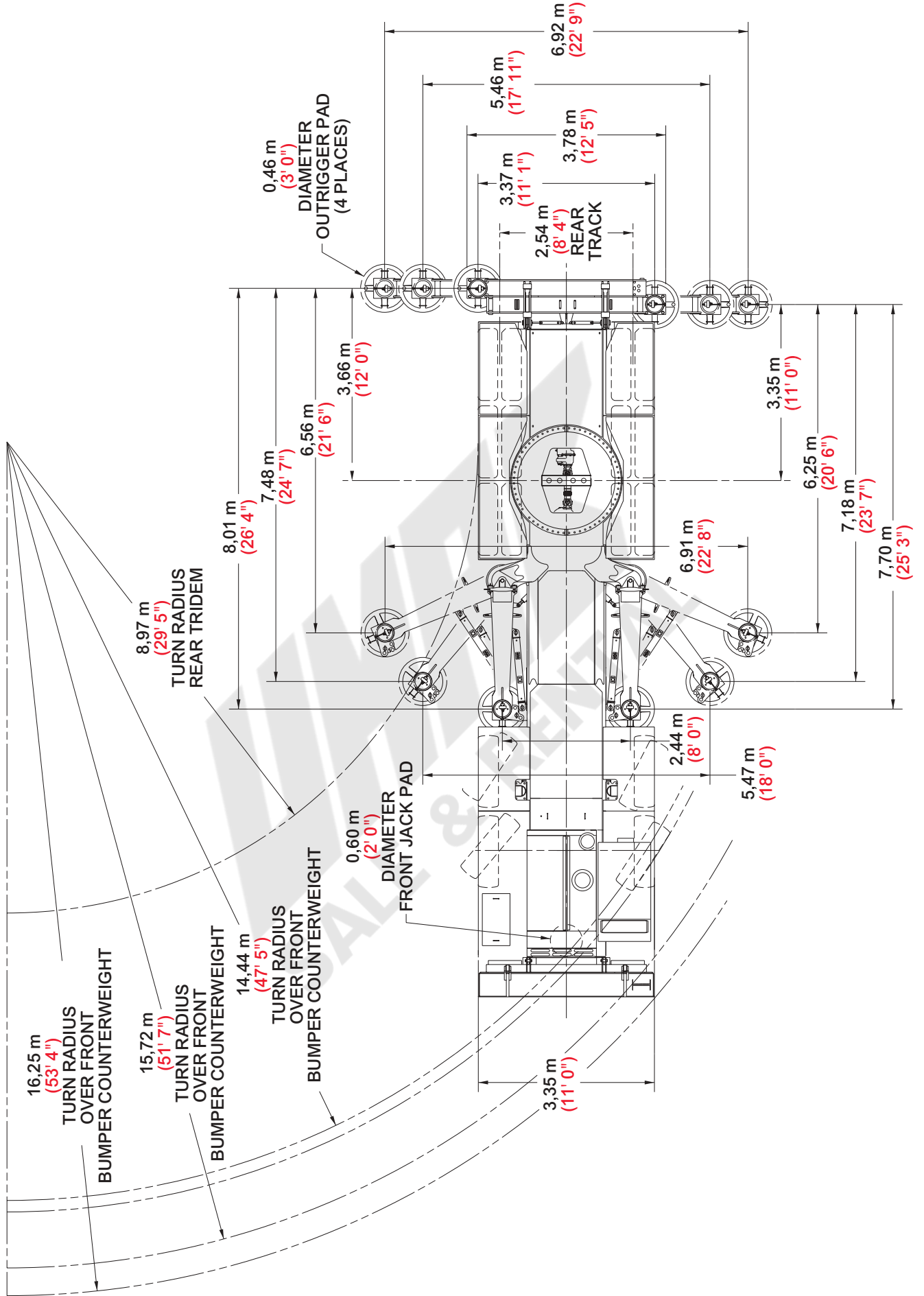

outline dimensions

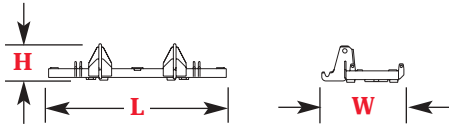

Counterweight - Upper Tray x 1

Length	3,35 m	11' 0"
Width	1,55 m	5' 1"
Height	0,69 m	2' 3"
Weight	4 717 kg	10,400 lb

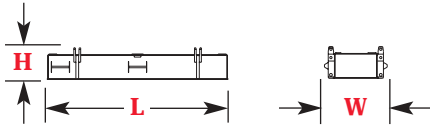

Counterweight - Upper x 5

Length	3,35 m	11' 0"
Width	0,58 m	1' 11"
Height	1,16 m	3' 10"
Weight	7 699 kg	16,975 lb

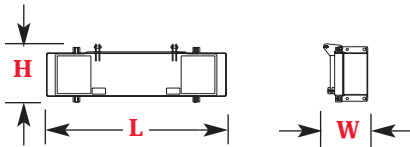

Counterweight - Front Bumper with Adapter x 1

Length	3,35 m	11' 0"
Width	0,74 m	2' 5"
Height	1,07 m	3' 6"
Weight	11 340 kg	25,000 lb

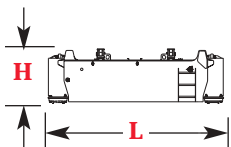

No. 78T Outriggers - Rear with Jacks and Pads x 1

Length	3,78 m	12' 5"
Width	1,13 m	3' 9"
Height	1,12 m	3' 8"
Weight	6 336 kg	13,970 lb

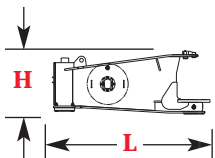

No. 78T Outrigger - Front with Jacks and Pads x 2

Length	2,96 m	9' 9"
Width	0,78 m	2' 6"
Height	1,20 m	3' 11"
Weight	1 830 kg	4,035 lb

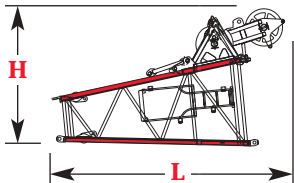

No. 78T Boom Upper Butt 4,0 m (13') & Wire Rope Guide x 1

Length	4,86 m	15' 10"
Width	2,24 m	7' 4"
Height	2,81 m	9' 3"
Weight	2 840 kg	6,625 lb

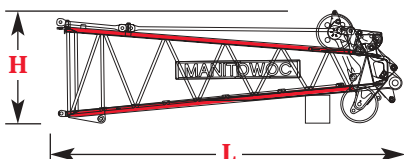

No. 78T Boom Top 6,1 m (20') & Wire Rope Guides, Straps, Lower Point x 1

Length	7,04 m	23' 1"
Width	2,24 m	7' 4"
Height	2,27 m	7' 6"
Weight	3 300 kg	7,275 lb

Option

9

model 777T



outline dimensions

10

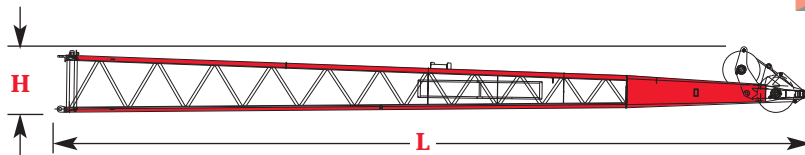

**No. 78T Boom Long Reach Top
15,2 m (50') & Wire Rope Guides,
Straps, Lower Point x 1**

Length	15,32 m	50' 3"
Width	2,24 m	7' 4"
Height	1,33 m	4' 5"
Weight	3 456 kg	7,620 lb

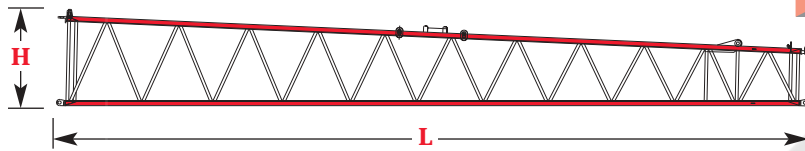

**No. 78T Boom Long Reach Insert
12,3 m (50') & Straps x 1**

Length	15,34 m	50' 4"
Width	2,24 m	7' 4"
Height	1,89 m	6' 8"
Weight	2 497 kg	5,505 lb

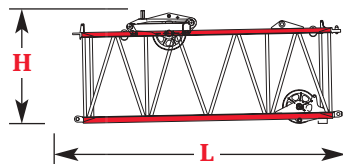

**No. 78T Boom Insert 5,3 m (17' 6")
& Wire Rope Guides, Straps x 1**

Length	5,48 m	18' 0"
Width	2,24 m	7' 4"
Height	2,39 m	7' 10"
Weight	2 112 kg	4,655 lb

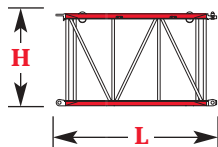

**No. 78 Boom Insert 3,0 m (10')
& Straps x 1, 2**

Length	3,35 m	11' 0"
Width	2,24 m	7' 4"
Height	1,89 m	6' 8"
Weight	660 kg	1,455 lb

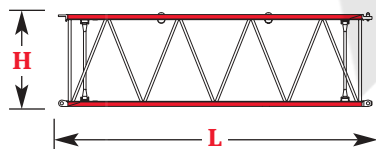

**No. 78 Boom Insert 6,1 m (20')
& Straps x 1, 2**

Length	6,40 m	21' 0"
Width	2,24 m	7' 4"
Height	1,89 m	6' 8"
Weight	1 148 kg	2,530 lb

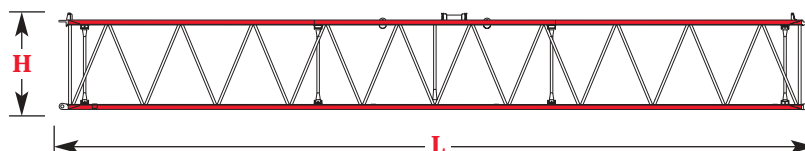

**No. 78T Boom Insert 15,2 m (50')
& Straps x 1, 2, 3, 4**

Length	15,55 m	51' 0"
Width	2,24 m	7' 4"
Height	1,89 m	6' 8"
Weight	2 483 kg	5,475 lb

Option

outline dimensions

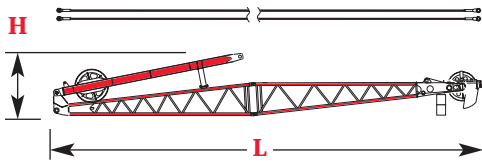

No. 134 Fixed Jib 9,1 m (30') & Strut, Pendants x 1

Length	9,60 m	31' 6"
Width	0,76 m	2' 6"
Height	0,91 m	3' 0"
Weight	1 055 kg	2,325 lb

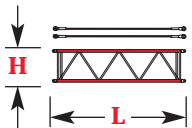

No. 134 Jib Insert 3,0 m (10') & Pendants x 1, 2

Length	3,12 m	10' 3"
Width	0,78 m	2' 7"
Height	0,78 m	2' 7"
Weight	213 kg	480 lb

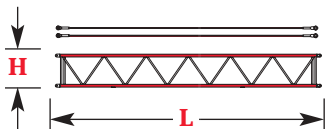

No. 134 Jib Insert 6,1 m (20') & Pendants x 1, 2

Length	6,16 m	20' 3"
Width	0,78 m	2' 7"
Height	0,78 m	2' 7"
Weight	339 kg	750 lb

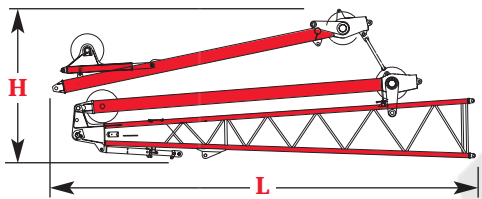

No. 139 Luffing Jib 8,2 m (27') Butt & Main Strut, Jib Strut, Guides, Pendants x 1

Length	8,78 m	28' 10"
Width	1,51 m	5' 0"
Height	3,14 m	10' 3"
Weight	5 056 kg	10,460 lb

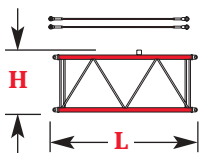

No. 139 Jib Insert 3,0 m (10') & Pendants x 1

Length	3,15 m	10' 4"
Width	1,51 m	5' 0"
Height	1,34 m	4' 5"
Weight	379 kg	840 lb

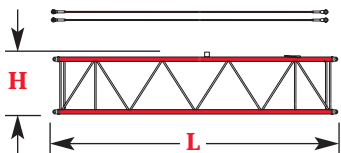

No. 139 Jib Insert 6,1 m (20') & Pendants x 1, 2

Length	6,20 m	20' 4"
Width	1,51 m	5' 0"
Height	1,34 m	4' 5"
Weight	610 kg	1,350 lb

Option

11

outline dimensions

12

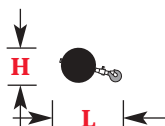
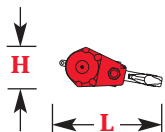
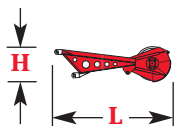
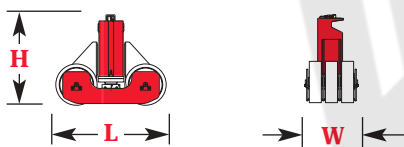
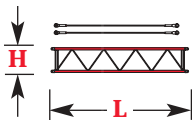
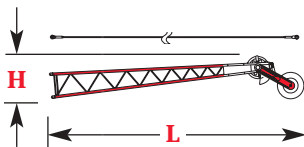
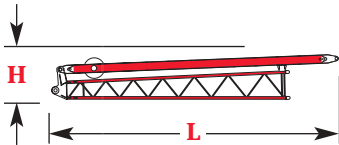
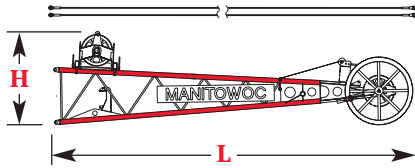
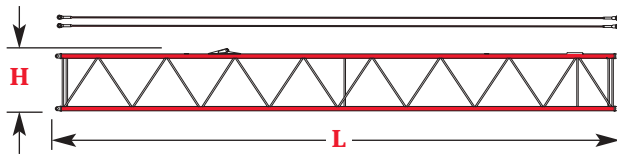

No. 139 Jib Insert 12,3 m (40') & Pendants x 1, 2

Length	12,40 m	40' 4"
Width	1,51 m	5' 0"
Height	1,34 m	4' 5"
Weight	1 048 kg	2,315 lb

No. 139 Jib Top 7,0 m (23') & Pendants x 1

Length	7,83 m	25' 8"
Width	1,51 m	5' 0"
Height	2,06 m	6' 9"
Weight	2 226 kg	4,915 lb

No. 138 Fixed Jib 4,6 m (15') Butt & Strut x 1

Length	5,64 m	18' 6"
Width	0,75 m	2' 6"
Height	0,91 m	3' 0"
Weight	350 kg	775 lb

No. 138 Fixed Jib 4,6 m (15') Top & Roller, Pendant x 1

Length	5,51 m	18' 1"
Width	0,76 m	2' 6"
Height	1,05 m	3' 5"
Weight	351 kg	773 lb

No. 138 Jib Insert 3,0 m (10') & Pendants x 1, 2, 3

Length	3,12 m	10' 3"
Width	0,76 m	2' 6"
Height	0,58 m	1' 11"
Weight	98 kg	215 lb

No. 78T Rolling Outrigger x 2

Length	1,63 m	5' 4"
Width	0,79 m	2' 7"
Height	1,29 m	4' 3"
Weight	1 830 kg	4,035 lb

No. 78 Upper Boom Point x 1

Length	2,64 m	8' 8"
Width	0,41 m	1' 4"
Height	0,81 m	2' 8"
Weight	420 kg	925 lb

Hook block for 26 mm or (1") wire rope

Capacity	160 mt	175 t	Length	1,68 m	5' 6"
Weight	2 268 kg	5,000 lb	Width	1,29 m	4' 0"

Weight Ball

Capacity/Swivel	13,6 mt	15 t	Diameter	0,56 m	1' 10"
Weight	594 kg	1 310 lb	Length	1,07 m	3' 6"

Option

transport data

13

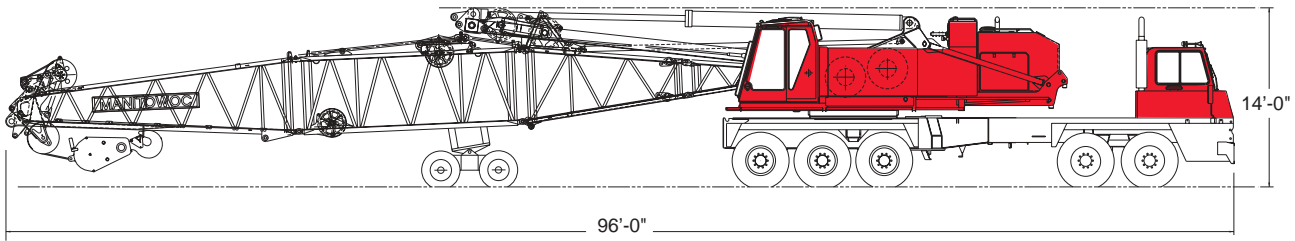

APPROXIMATE GROSS WEIGHT: 137,925 LB

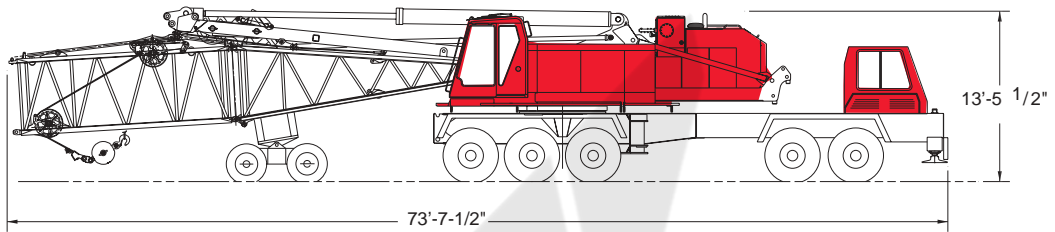

APPROXIMATE GROSS WEIGHT: 127,385 LB

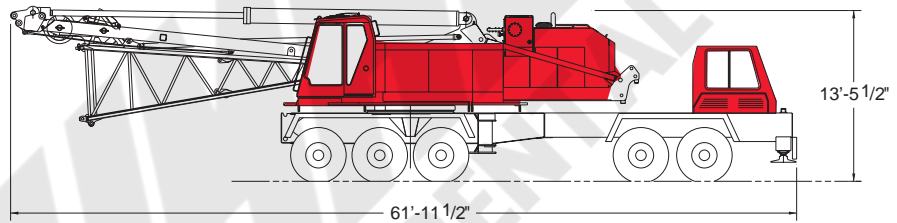

APPROXIMATE GROSS WEIGHT: 118,305 LB

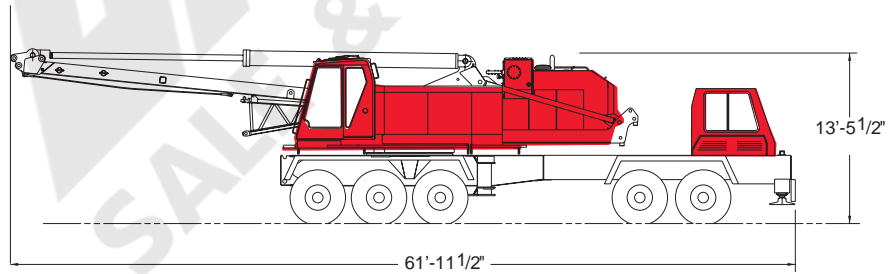

APPROXIMATE GROSS WEIGHT: 112,040 LB

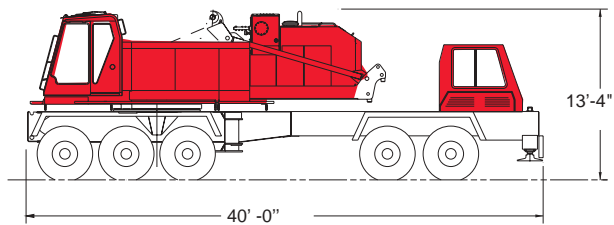

APPROXIMATE GROSS WEIGHT: 100,240 LB

transport data

14

Trailer Load Out Summary

Item	Weight each Item kg (lb)	Quantity on Trailer Load #						
		0	1	2	3	4	5	6
Model 777T Series 2 No. 78 Boom 79,3 m (250') and No. 134 Fixed Jib 24,4 m (80')								
777 Truck Normal Configuration	50 820 (112,040)	1						
Counterweight Tray	4 717 (10,400)		1					
Counterweight Box - Upper	7 699 (16,975)				2	2	1	
Counterweight - Front Bumper	3 649 (8,045)			1				
Counterweight - Front Adapter	7 699 (16,975)							1
Outrigger, Jacks & Pad - Rear	6 336 (13,970)		1					
Outrigger, Jacks & Pads - Front	1 830 (4,035)			2				
6,1 m (22' 6") No. 78T Upper Butt & Guides	2 840 (6,265)			1				
6,1 m (20') No. 78T Top, Guides & Straps	3 498 (7,715)		1					
5,3 m (17') No. 78T Boom Insert & Straps	2 023 (4,465)			1				
3,0 m (10') No. 78T Boom Insert & Straps	753 (1,660)							2
6,1 m (20') No. 78T Boom Insert & Straps	1 116 (2,460)							1
15,2 m (50') No. 78T Boom Insert & Straps	2 471 (5,455)				1	1	1	
9,1 m (30') No. 134 Jib & Pendants	1 055 (2,325)							1
3,0 m (10') No. 134 Jib Insert & Pendants	213 (480)						1	
6,1 m (20') No. 134 Jib Insert & Pendants	339 (750)						1	1
Upper Boom Point	420 (925)		1					
160-mton (175-ton) Hook Block	2 268 (5,000)		1					
Miscellaneous*								
Approximate Total Shipping Weight Each Trailer Load kg (lb)	50 820 (112,040)	17 239 (38,010)	12 172 (26,845)	17 869 (39,405)	17 869 (39,405)	10 722 (23,660)	11 715 (23,505)	

*Miscellaneous weights vary and are not itemized for individual trailer load totals.

Trailer configurations - double drop (#2); step deck (#s 1, 3-5); flat bed (# 6).

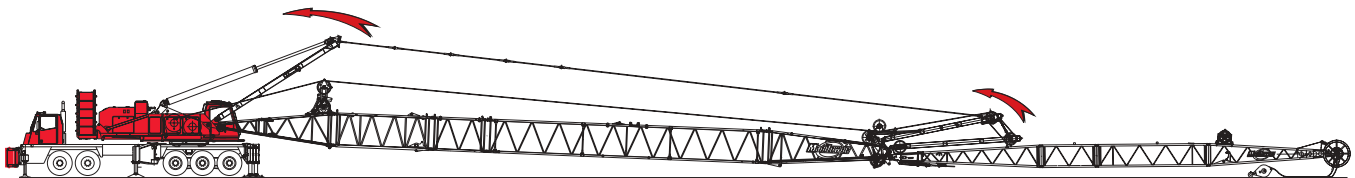
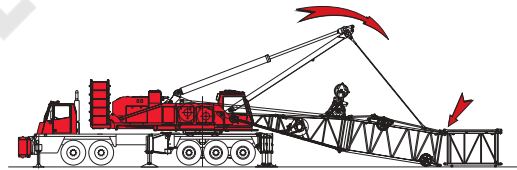
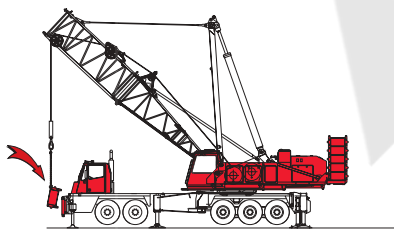
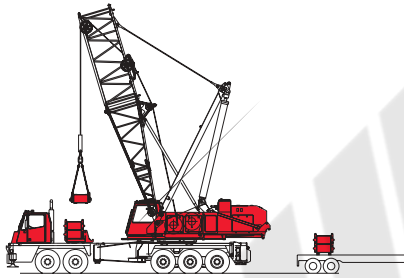
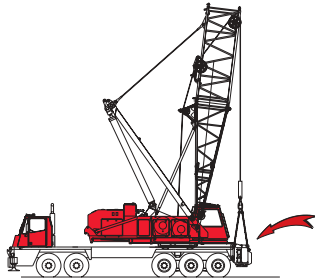
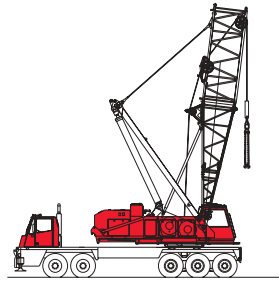
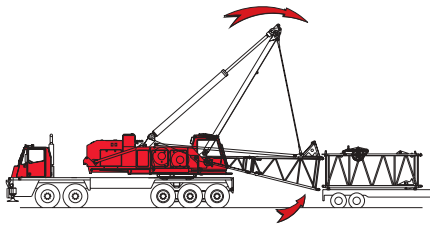

Note: Read the assembly folio in the operator's manual for a complete description of approved crane assembly procedures.

performance data

16

Wire Rope Lengths
Boom No. 78T
 - or -
Fixed Jib No. 134 on Boom No. 78T with HL top

Boom or Boom and Jib Length	Whip Line				Front or Rear Drum			Auxiliary Drum		
	Front, Rear or Auxiliary Drum				26 mm or (1") Hoist Line			32 mm or (1-1/4") Hoist Line		
	(1 Part of Line)		(2 Parts of Line)		Maximum Required Parts of Line		Maximum Required Parts of Line		Maximum Required Parts of Line	
m (ft)	m	(ft)	m	(ft)	m	(ft)	m	(ft)	m	(ft)
13,0 (42.5)	49	(160)	67	(220)	221	(725)	13	214	(700)	12
18,3 (60)	52	(170)	73	(240)	297	(975)	13	274	(900)	12
21,3 (70)	58	(190)	82	(270)	297	(975)	11	312	(1,025)	12
24,4 (80)	64	(210)	91	(300)	305	(1,000)	10	351	(1,150)	12
27,4 (90)	70	(230)	101	(330)	335	(1,100)	10	396	(1,300)	12
30,5 (100)	76	(250)	110	(360)	335	(1,100)	9	434	(1,425)	12
33,5 (110)	82	(270)	119	(390)	335	(1,100)	8	434	(1,425)	11
36,6 (120)	88	(290)	128	(420)	335	(1,100)	7	434	(1,425)	10
39,6 (130)	94	(310)	137	(450)	343	(1,125)	7	434	(1,425)	9
42,7 (140)	101	(330)	146	(480)	343	(1,125)	6	457	(1,500)	9
45,7 (150)	107	(350)	155	(510)	343	(1,125)	5	457	(1,500)	8
48,8 (160)	113	(370)	165	(540)	343	(1,125)	5	457	(1,500)	7
51,8 (170)	119	(390)	174	(570)	343	(1,125)	5	457	(1,500)	7
54,9 (180)	125	(410)	183	(600)	351	(1,150)	5	457	(1,500)	6
57,9 (190)	131	(430)	192	(630)	366	(1,200)	5	457	(1,500)	6
61,0 (200)	137	(450)	201	(660)	366	(1,200)	4	457	(1,500)	6
64,0 (210)	143	(470)	210	(690)	366	(1,200)	4	472	(1,550)	6
67,1 (220)	149	(490)	219	(720)	366	(1,200)	4	488	(1,600)	6
70,1 (230)	155	(510)	229	(750)	366	(1,200)	4	488	(1,600)	5
73,2 (240)	162	(530)	238	(780)	366	(1,200)	3	488	(1,600)	5
76,2 (250)	168	(550)	247	(810)	366	(1,200)	3	488	(1,600)	5
79,2 (260)	174	(570)	256	(840)	366	(1,200)	3	488	(1,600)	5
82,3 (270)	180	(590)	265	(870)	366	(1,200)	3	488	(1,600)	4
85,3 (280)	186	(610)	274	(900)						
88,4 (290)	192	(630)								
91,4 (300)	198	(650)								

Note: Line lengths are based on single part lead line. Hoist line and whip line lengths given in table will allow hook to touch ground. When block travel below ground is required, add additional rope equal to parts of line times added travel distance. Hoisting distance or line pull may be limited when block travel below ground is required.

Auxiliary Drum cannot be used with 18,3 m (60') or less boom length.

Capacity chart restrictions will occur when auxiliary drum is used. Maximum capacity is 108 860 kg (240,000 lb) with 12 parts line.

Wire Rope Lengths
Boom No. 78T
- or -
Fixed Jib No. 134 on Boom No. 78T with LR top

Boom or Boom and Jib Length	Whip Line				Front or Rear Drum		Auxiliary Drum			
	Front, Rear or Auxiliary Drum				26 mm or (1") Hoist Line		32 mm or (1-1/4") Hoist Line		Maximum Required Parts of Line	
	(1 Part of Line)		(2 Parts of Line)		m	(ft)	m	(ft)		
m (ft)	m	(ft)	m	(ft)	m	(ft)	m	(ft)		
42,1 (138)					274	(900)	5	320	(1,050)	6
45,1 (148)					290	(950)	5	335	(1,100)	6
48,2 (158)					312	(1,025)	5	358	(1,175)	6
51,2 (168)	113	(370)	168	(550)	328	(1,075)	5	381	(1,250)	6
54,3 (178)	119	(390)	177	(580)	351	(1,150)	5	404	(1,325)	6
57,3 (188)	125	(410)	186	(610)	366	(1,200)	5	427	(1,400)	6
60,4 (198)	131	(430)	195	(640)	366	(1,200)	4	442	(1,425)	6
63,4 (208)	137	(450)	204	(670)	366	(1,200)	4	465	(1,450)	6
66,4 (218)	143	(470)	213	(700)	366	(1,200)	4	488	(1,525)	6
69,5 (228)	149	(490)	223	(730)	366	(1,200)	4	488	(1,600)	5
72,5 (238)	155	(510)	232	(760)	366	(1,200)	3	488	(1,600)	5
75,6 (248)	162	(530)	241	(790)	366	(1,200)	3	488	(1,600)	4
78,6 (258)	168	(550)	250	(820)	366	(1,200)	3	488	(1,600)	4
81,7 (268)	174	(570)	259	(850)	366	(1,200)	3	488	(1,600)	4
84,7 (278)	180	(590)	268	(880)	366	(1,200)	2	488	(1,600)	3
87,8 (288)	186	(610)	277	(910)	366	(1,200)	2	488	(1,600)	3
90,8 (298)	192	(630)	287	(940)	366	(1,200)	2	488	(1,600)	3
93,9 (308)	198	(650)								
96,9 (318)	204	(670)								

Note: Line lengths are based on single part lead line. Hoist line and whip line lengths given in table will allow hook to touch ground. When block travel below ground is required, add additional rope equal to parts of line times added travel distance. Hoisting distance or line pull may be limited when block travel below ground is required.

Capacity chart restrictions will occur when auxiliary drum is used. Maximum capacity is 54 430 kg (120,000 lb) with 6 parts line.

SALE & RENTAL

performance data

18

Wire Rope Lengths Luffing Jib No. 139 on Boom No. 78T with HL top

Boom and Luffing Jib Length	Luffing Jib Hoist Line Front Drum							
	(4 Parts of Line)		(3 Parts of Line)		(2 Parts of Line)		(1 Part of Line)	
	m	(ft)	m	(ft)	m	(ft)	m	(ft)
39,6 (130)	221	(725)					91	(300)
42,7 (140)	236	(775)					98	(320)
45,7 (150)	251	(825)	198	(650)			104	(340)
48,8 (160)	267	(875)	213	(700)			110	(360)
51,8 (170)	282	(925)	229	(750)			116	(380)
54,9 (180)	297	(975)	236	(775)			122	(400)
57,9 (190)	312	(1,025)	251	(825)	191	(625)	128	(420)
61,0 (200)	328	(1,075)	259	(850)	198	(650)	134	(440)
64,0 (210)	343	(1,125)	274	(900)	206	(675)	140	(460)
67,1 (220)	358	(1,175)	290	(950)	213	(700)	146	(480)
70,1 (230)			297	(975)	229	(750)	152	(500)
73,2 (240)			312	(1,025)	236	(775)	158	(520)
76,2 (250)			320	(1,050)	244	(800)	165	(540)
79,2 (260)			335	(1,100)	251	(825)	171	(560)
82,3 (270)					259	(850)	177	(580)
85,3 (280)					267	(875)	183	(600)
88,4 (290)					282	(925)	189	(620)
91,4 (300)					290	(950)	195	(640)
94,5 (310)					297	(975)	201	(660)
97,5 (320)					305	(1,000)	207	(680)
100,6 (330)					312	(1,025)	213	(700)
103,6 (340)							219	(720)
106,7 (350)							226	(740)

Note: Line lengths are based on single part lead line. Hoist line and whip line lengths given in table will allow hook to touch ground. When block travel below ground is required, add additional rope equal to parts of line times added travel distance. Hoisting distance or line pull may be limited when block travel below ground is required.

Capacity chart restrictions will occur when auxiliary drum is used. Maximum capacity is 36 290 kg (80,000 lb) with four parts of line.

Wire Rope Lengths Luffing Jib No. 139 on Boom No. 78T with HL top

Boom and Luffing Jib Length	Luffing Jib Hoist Line Auxiliary Drum							
	(4 Parts of Line)		(3 Parts of Line)		(2 Parts of Line)		(1 Part of Line)	
	m (ft)	m (ft)	m (ft)	m (ft)	m (ft)	m (ft)	m (ft)	
39,6 (130)	221	(725)					91	(300)
42,7 (140)	236	(775)					98	(320)
45,7 (150)	251	(825)					104	(340)
48,8 (160)	267	(875)					110	(360)
51,8 (170)	282	(925)					116	(380)
54,9 (180)	297	(975)					122	(400)
57,9 (190)	312	(1,025)	251	(825)			128	(420)
61,0 (200)	328	(1,075)	259	(850)			134	(440)
64,0 (210)	343	(1,125)	274	(900)			140	(460)
67,1 (220)	358	(1,175)	290	(950)	213	(700)	146	(480)
70,1 (230)	373	(1,225)	297	(975)	229	(750)	152	(500)
73,2 (240)	389	(1,275)	312	(1,025)	236	(775)	158	(520)
76,2 (250)	404	(1,325)	320	(1,050)	244	(800)	165	(540)
79,2 (260)	419	(1,375)	335	(1,100)	251	(825)	171	(560)
82,3 (270)			351	(1,150)	259	(850)	177	(580)
85,3 (280)			358	(1,175)	267	(875)	183	(600)
88,4 (290)			373	(1,225)	282	(925)	189	(620)
91,4 (300)			381	(1,250)	290	(950)	195	(640)
94,5 (310)					297	(975)	201	(660)
97,5 (320)					305	(1,000)	207	(680)
100,6 (330)					312	(1,025)	213	(700)

Wire Rope Lengths Fixed Jib No. 138 on Luffing Jib No. 139 on Boom No. 78T with HL top

Boom, Luffing Jib, & Fixed Jib Length	Front Drum or Auxiliary Drum	
	(1 Part of Line)	
m (ft)	m	(ft)
94,5 (310)	201	(600)
97,5 (320)	207	(680)
100,6 (330)	213	(700)
103,6 (340)	219	(720)
106,7 (350)	226	(740)
109,7 (360)	232	(760)
112,8 (370)	238	(780)
115,8 (380)	244	(800)
118,9 (390)	250	(820)
121,9 (400)	256	(840)
125,0 (410)	262	(860)

Note: Line lengths are based on single part lead line. Hoist line and whip line lengths given in table will allow hook to touch ground. When block travel below ground is required, add additional rope equal to parts of line times added travel distance. Hoisting distance or line pull may be limited when block travel below ground is required.

Capacity chart restrictions will occur when auxiliary drum is used. Maximum capacity is 36 290 kg (80,000 lb) with four parts of line.

Note: Line lengths are based on single part lead line. Hoist line and whip line lengths given in table will allow hook to touch ground. When block travel below ground is required, add additional rope equal to parts of line times added travel distance. Hoisting distance or line pull may be limited when block travel below ground is required.

Front drum maximum load on 1" wire rope is 12 250 kg (27,000 lb) per line.

Auxiliary drum maximum load on 26 mm or 1" wire rope is 9 070 kg (20,000 lb) per line.

performance data

20

Wire Rope Specifications 5:1 Safety Factor
Boom No. 78T
 - or -
Boom No. 78T with Long Reach Top
 - or -
Fixed Jib No. 134 on Boom No. 78T
 - or -
Fixed Jib No. 134 on Boom No. 78T with Long Reach Top
 - or -
Luffing Jib No. 139 on Boom No. 78T
 - or -
Fixed Jib No. 138 on Luffing Jib No. 139 on Boom No. 78T

Part Number Function	5:1 Safety Factor 2 160 N/nm ² Rotation Resistant		
	No. 719392* Hoist Line Whip Line	No. 719393 Auxiliary Line	No. 719378 Auxiliary Line
Size Wire Rope	- (1")	- (1")	26 mm -
Minimum Breaking Strength	684,2 kN (153,800 lb)	620,9 kN (139,600 lb)	650,6 kN (146,200 lb)
Maximum Load Per Line	13 380 kg (29,500 lb)	9 070 kg (20,000 lb)	9 070 kg (20,000 lb)
Approximate Weight	3,02 kg/m (2.03 lb/ft)	3,02 kg/m (2.03 lb/ft)	3,17 kg/m (2.13 lb/ft)

* Not Required for Fixed Jib No. 138 on Luffing Jib No. 139 on Boom No. 78T.

Wire Rope Specifications 3.5:1 Safety Factor
Boom No. 78T
 - or -
Boom No. 78T with Long Reach Top
 - or -
Fixed Jib No. 134 on Boom No. 78T
 - or -
Fixed Jib No. 134 on Boom No. 78T with Long Reach Top
 - or -
Luffing Jib No. 139 on Boom No. 78T
 - or -
Fixed Jib No. 138 on Luffing Jib No. 139 on Boom No. 78T

Part Number Function	3.5:1 Safety Factor Right Regular Lay, 6x25 Filler Wire, Extra Improved Plow Steel, IWRC		
	No. 719060 Hoist Line Whip Line	No. 719073 Auxiliary Line	No. 719387 Auxiliary Line
Size Wire Rope	- (1")	- (1")	26 mm -
Minimum Breaking Strength	460,0 kN (103,400 lb)	40 730 kg (89,890 lb)	483,1 kN (108,600 lb)
Maximum Load Per Line	13 380 kg (29,500 lb)	9 070 kg (20,000 lb)	13 380 kg (29,500 lb)
Approximate Weight	2,75 kg/m (1.85 lb/ft)	2,75 kg/m (1.85 lb/ft)	2,89 kg/m (1.94 lb/ft)

Drums & Laggings

		Tandem Drums							
Application	Drum Location	Drum Part Number	Drum Type	Drum Diameter	Drum Width	Optional Grooved Lagging Part Number	Lagging Diameter	Wire Rope Size	
Basic Liftercrane	Hoist	Front	192700	Grooved	540 mm (21-1/4")	765 mm (30-1/8")			- 1"
	Hoist (Optional Dual Input Drive)	Front	192700	Grooved	540 mm (21-1/4")	765 mm (30-1/8")			- 1"
	Whip	Rear	192700	Grooved	540 mm (21-1/4")	765 mm (30-1/8")			- 1"
	Whip (Optional Dual Input Drive)	Rear	192700	Grooved	540 mm (21-1/4")	765 mm (30-1/8")			- 1"
	Hoist (Auxiliary)	Boom Butt	177379	Bare	495 mm (19-1/2")	940 mm (37")	502372 502382	540 mm (21-1/4") 540 mm (21-1/4")	26 mm - 1"
Luffing Jib Liftercrane	Hoist	Front	192700	Grooved	540 mm (21-1/4")	765 mm (30-1/8")			- 1"
	Hoist (Auxiliary)	Boom Butt	177379	Bare	495 mm (19-1/2")	940 mm (37")	502372 502382	540 mm (21-1/4") 540 mm (21-1/4")	26 mm - 1"

Drum Capacities - Wire Rope

	Maximum Length	
	No Lagging	With Lagging
Front or Rear Grooved Drum (Hoist or Whip) (1") Wire Rope	283 m (928 ft) 5 Layers	
Auxiliary Drum (Whip) 26 mm Wire Rope or (1") Wire Rope	403 m (1,323 ft) 6 Layers	431 m (1,415 ft) 6 Layers*
	407 m (1,335 ft) 6 Layers	435 m (1,428 ft) 6 Layers

Note: 5 m (17') is deducted from maximum spooling capacities for 3 dead wraps per drum or lagging.

*Lagging diameter 540 mm (21-1/4").

performance data

22

Main & Whip Drums - 131 kN (29,500 lb)

Layer	High Speed Drum - Continuous Duty Single Line Pull/Single Line Speed				
	m/min (ft/min)				
	1	2	3	4	5
Line Pull kg (lb)					
0 (0)	131 (428)	142 (466)	154 (505)	166 (543)	177 (581)
2 268 (5,000)	120 (392)	129 (424)	139 (455)	148 (485)	157 (515)
4 536 (10,000)	103 (337)	104 (340)	104 (342)	105 (345)	106 (347)
6 803 (15,000)	71 (234)	72 (237)	73 (239)	74 (242)	74 (244)
9 072 (20,000)	56 (183)	56 (185)	57 (188)	58 (190)	59 (193)
11 340 (25,000)	46 (152)	47 (154)	48 (157)	49 (160)	49 (162)
13 380 (29,500)	41 (133)	42 (136)	42 (138)	43 (141)	44 (143)

NOTE: Line pull is infinitely variable. With 540 mm (21-1/4") lagging for 26 mm or (1") wire rope.

Maximum Length - Unassisted Raising

Method	No. 134 Fixed Jib on No. 78T Heavy-Lift	
	Main Boom	Fixed Jib
m (ft)	82,3 (270)	-
	79,2 (260)	-
	76,2 (250)	-
	73,2 (240)	9,1 (30)
Over Rear of Outriggers	70,1 (230)	15,2 (50)
	67,1 (220)	24,4 (80)
	67,1 (220)	-
Over side of Fully Extended Outriggers	64,0 (210)	-
	61,0 (200)	9,1 (30)
	57,9 (190)	18,3 (60)
	54,9 (180)	24,4 (80)

Note: Load block(s), hook(s) and weight ball(s) on ground at start.

Main & Whip Drums - 131 kN (29,500 lb)

Layer	Standard Speed Drum - Continuous Duty Single Line Pull/Single Line Speed				
	m/min (ft/min)				
	1	2	3	4	5
Line Pull kg (lb)					
0 (0)	99 (325)	108 (354)	117 (383)	126 (413)	135 (442)
2 268 (5,000)	93 (304)	101 (330)	108 (355)	116 (379)	123 (404)
4 536 (10,000)	87 (284)	93 (305)	99 (326)	103 (337)	104 (340)
6 803 (15,000)	70 (231)	71 (234)	73 (238)	74 (241)	75 (245)
9 072 (20,000)	56 (183)	57 (186)	58 (190)	59 (193)	60 (197)
11 340 (25,000)	47 (154)	48 (158)	49 (161)	51 (165)	51 (168)
13 380 (29,500)	42 (137)	43 (140)	44 (144)	45 (147)	46 (151)

NOTE: Line pull is infinitely variable. With 540 mm (21-1/4") lagging for 26 mm or (1") wire rope.

performance data

23

Maximum Length – Unassisted Raising

Method	No. 134 Fixed Jib on No. 78T Long-Reach	
	Main Boom	Fixed Jib
Over Rear of Outriggers	90,8 (298)	-
	87,8 (288)	-
	84,7 (278)	-
	81,7 (268)	9,1 (30)
	78,6 (258)	9,1 (30)
	75,6 (248)	18,3 (60)
	72,5 (238)	24,4 (80)
Over side of Fully Extended Outriggers	75,6 (248)	-
	72,5 (238)	-
	69,5 (228)	9,1 (30)
	66,4 (218)	18,3 (60)
	63,4 (208)	24,4 (80)

Note: Load block(s), hook(s) and weight ball(s) on ground at start.

Maximum Length – Unassisted Raising

Method	No. 139 Luffing Jib on No. 78T Main Boom with 11 340 kg (25,000 lb) Front Bumper Counterweight			
	In-Line Procedure		Jack-Knife Procedure	
	Main Boom	Luffing Jib	Main Boom	Luffing Jib
With 11 340 kg (25,000 lb) Front Bumper Counterweight m (ft)	18,3 (60)	21,3 - 51,8 (70 - 170)		
	21,3 (70)	21,3 - 51,8 (70 - 170)		
	24,4 (80)	21,3 - 51,8 (70 - 170)		
	27,4 (90)	21,3 - 51,8 (70 - 170)		
	30,5 (100)	21,3 - 51,8 (70 - 170)		
	33,5 (110)	21,3 - 48,8 (70 - 160)	33,5 (110)	51,8 (170)
	36,6 (120)	21,3 - 42,7 (70 - 140)	36,6 (120)	45,7 - 51,8 (150 - 170)
	39,6 (130)	21,3 - 36,6 (70 - 120)	39,6 (130)	39,6 - 51,8 (130 - 170)
	42,7 (140)	21,3 - 30,5 (70 - 100)	42,7 (140)	33,5 - 51,8 (110 - 170)
	45,7 (150)	21,3 (70)	45,7 (150)	24,4 - 51,8 (80 - 170)
			48,8 (160)	21,3 - 51,8 (70 - 170)
			51,8 (170)	21,3 - 51,8 (70 - 170)
			54,9 (180)	21,3 - 51,8 (70 - 170)

NOTE: Load block(s), hook(s) and weight ball(s) on ground at start.

Working Weight

Configuration	kg (lb) 777T Complete
13,0 m (42' 6") No. 78T Main Boom with HL top	125 100 (275,800)
67,1 m (220') No. 78T Main Boom combined with 24,4 m (80') No. 134 Fixed Jib	136 402 (300,715)

Typical working weight consists of: maximum counter and bumper weights, hydraulic reservoirs full, fuel half-full, drums loaded with standard lengths of wire rope, upper boom point, 160 mt (175 t) hook block on 13,0 m (42' 6") boom or 54,4 mt (60 t) on 67,1 m (220') boom, and standard weight ball.

Note: Upper boom point not used with fixed jib.

Maximum Length – Unassisted Raising

Method	Fixed Jib No. 138 on No. 139 Luffing Jib on No. 78T Main Boom with 11 340 kg (25,000 lb) Front Bumper Counterweight		
	Layout Jack-Knife Procedure		
	Main Boom	Luffing Jib	Fixed Jib
With 11 340 kg (25,000 lb) Front Bumper Counterweight m (ft)	42,7 (140)	42,7 - 51,8 (140 - 170)	9,1 - 18,3 (30 - 60)
	48,8 (160)	42,7 - 51,8 (140 - 170)	9,1 - 18,3 (30 - 60)
	51,8 (170)	42,7 - 51,8 (140 - 170)	9,1 - 18,3 (30 - 60)
	54,9 (180)	42,7 - 51,8 (140 - 170)	9,1 - 18,3 (30 - 60)

NOTE: Load block(s), hook(s) and weight ball(s) on ground at start.

boom combinations

24

No. 78T Main Boom Combinations

Boom Length m (ft)	Boom Inserts			
	3,0 m (17.5 ft)	3,0 m (10 ft)	6,1 m (20 ft)	12,2 m (40 ft)
13,0 (42.5)	-	-	-	-
18,3 (60)	1	-	-	-
21,3 (70)	1	1	-	-
24,4 (80)	1	-	1	-
27,4 (90)	1	1	1	-
30,5 (100)	1	-	-	1
33,5 (110)	1	1	-	1
36,6 (120)	1	-	1	1
39,6 (130)	1	1	1	1
42,7 (140)	1	-	-	2
45,7 (150)	1	1	-	2
48,8 (160)	1	-	1	2
51,8 (170)	1	1	1	2
54,9 (180)	1	-	-	3
57,9 (190)	1	1	-	3
61,0 (200)	1	-	1	3
64,0 (210)	1	1	1	3
67,1 (220)	1	-	-	4
70,1 (230)	1	1	-	4
73,2 (240)	1	-	1	4
76,2 (250)	1	1	1	4
79,2 (260)	1	-	-	5
82,3 (270)	1	1	2	4

Note: Intermediate suspension required for 57,9 m (190') and longer boom lengths.

No. 134 Fixed Jib Combinations

Jib Length m (ft)	Fixed Jib Inserts	
	3,0 m (10 ft)	6,1 m (20 ft)
9,1 (30)	-	-
12,2 (40)	1	-
15,2 (50)	-	1
18,3 (60)	1	1
21,3 (70)	-	2
24,4 (80)	1	2

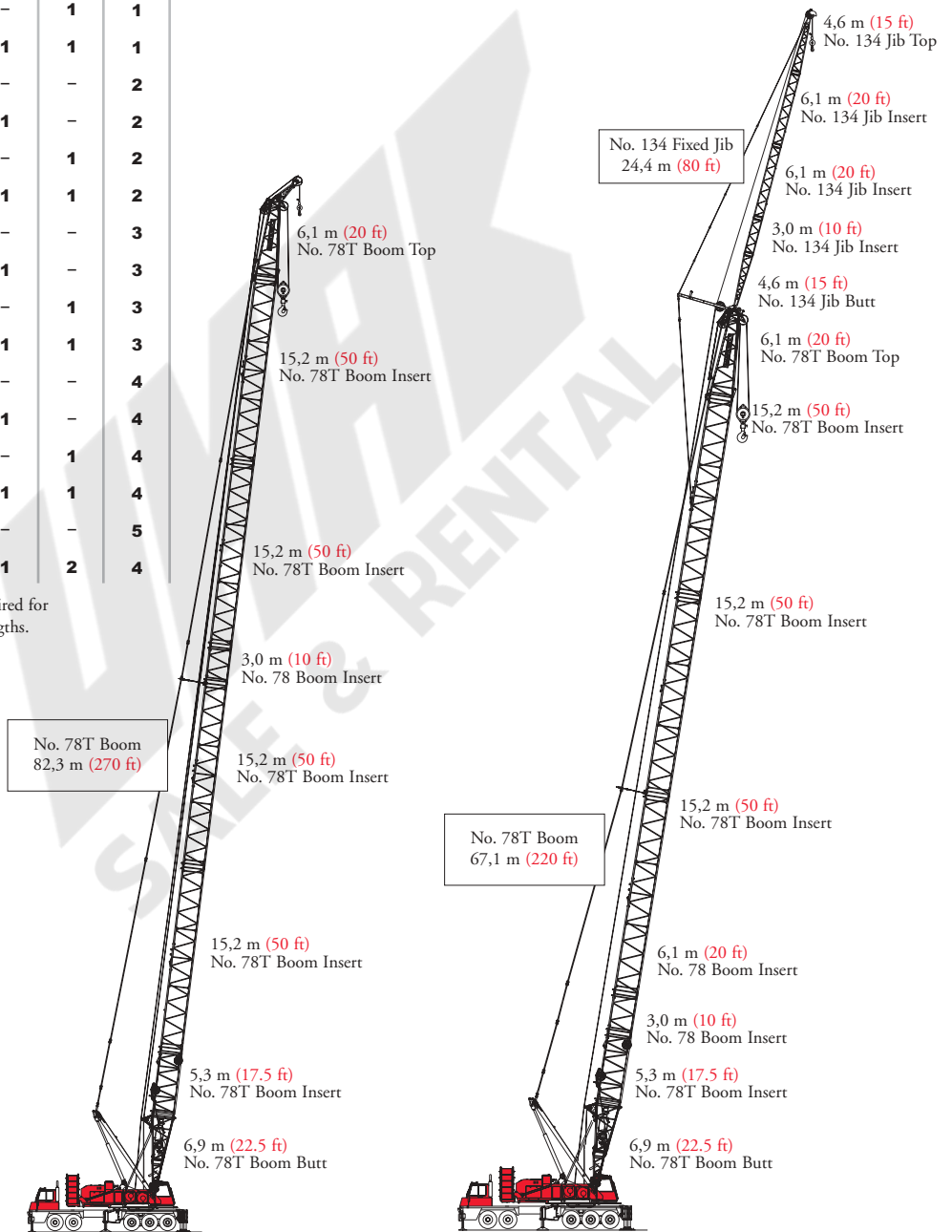

**Model 777T
No. 78T Main Boom
82,3 m (270 ft)**

**Model 777T
No. 134 Fixed jib on
No. 78T Main Boom
91,4 m (300 ft)**

boom combinations

No. 78T Main Boom with LR Top Combinations

Boom Length m (ft)	Boom Inserts			
	3,0 m (17.5 ft)	3,0 m (10 ft)	6,1 m (20 ft)	15,2 m (50 ft)
42,1 (138)	1	-	-	-
45,1 (148)	1	1	-	-
48,2 (158)	1	-	1	-
51,2 (168)	1	1	1	-
54,3 (178)	1	-	2	-
57,3 (188)	1	-	-	1
60,4 (198)	1	1	-	1
63,4 (208)	1	-	1	1
66,4 (218)	1	1	1	1
69,5 (228)	1	-	2	2
72,5 (238)	1	-	-	2
75,6 (248)	1	1	-	2
78,6 (258)	1	-	1	2
81,7 (268)	1	1	1	2
84,7 (278)	1	-	2	2
87,8 (288)	1	-	-	3
90,8 (298)	1	1	-	3

Note: Intermediate suspension required for 51,2 m (168') and longer boom lengths.

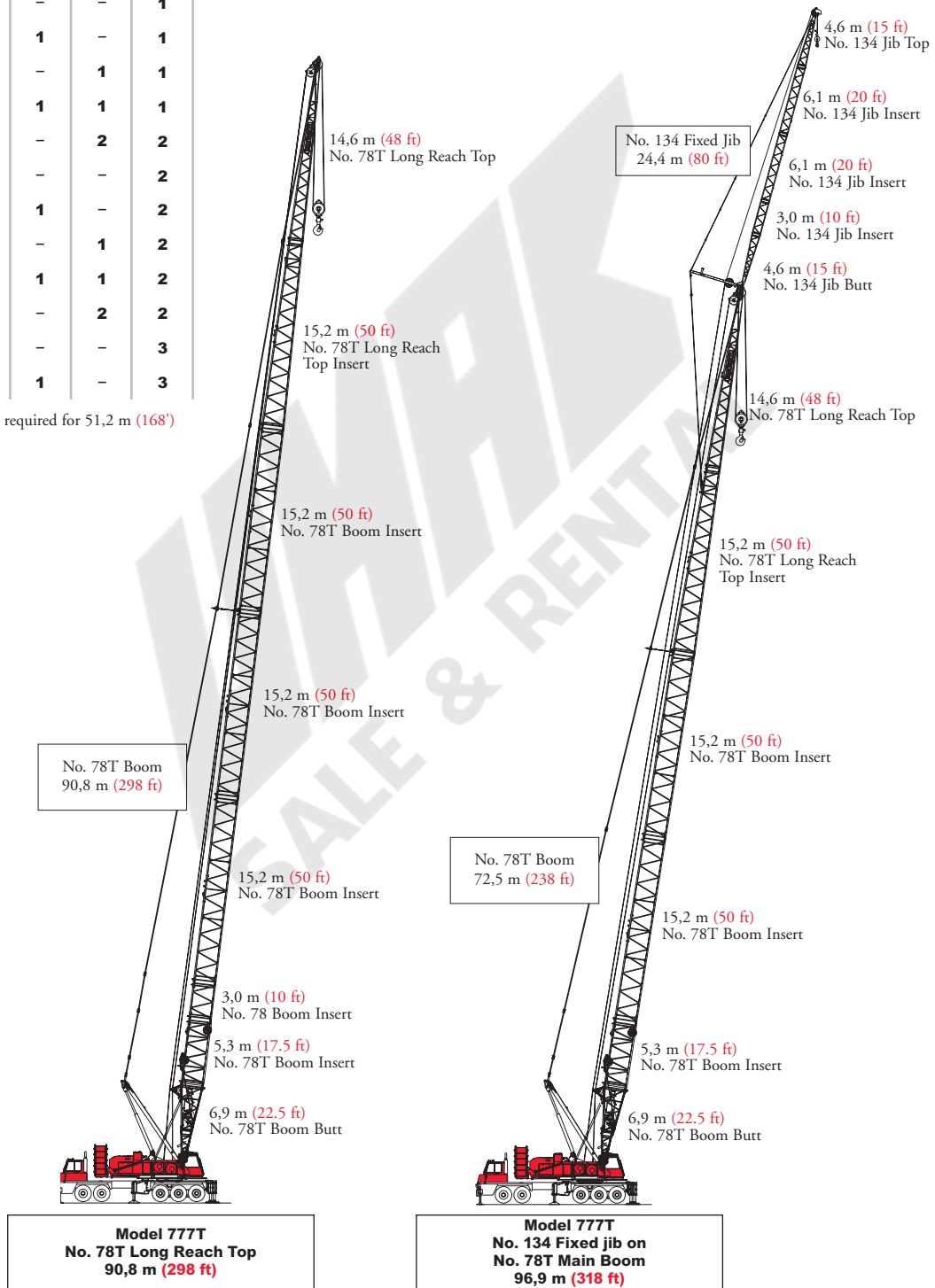

boom combinations

26

No. 139 Luffing Jib Combinations

Jib Length m (ft)	Luffing Jib Inserts		
	3,0 m (10 ft)	6,1 m (20 ft)	12,2 m (40 ft)
21,3 (70)	-	1	-
24,4 (80)	1	1	-
27,4 (90)	-	-	1
30,5 (100)	1	-	1
33,5 (110)	-	1	1
36,6 (120)	1	1	1
39,6 (130)	-	-	2
42,7 (140)	1	-	2
45,7 (150)	-	1	2
48,8 (160)	1	1	2
51,8 (170)	0	0	3

No. 138 Fixed Jib Combinations

Jib Length m (ft)	Fixed Jib Inserts
	3,0 m (10 ft)
9,1 (30)	-
12,2 (40)	1
15,2 (50)	2
18,3 (60)	3

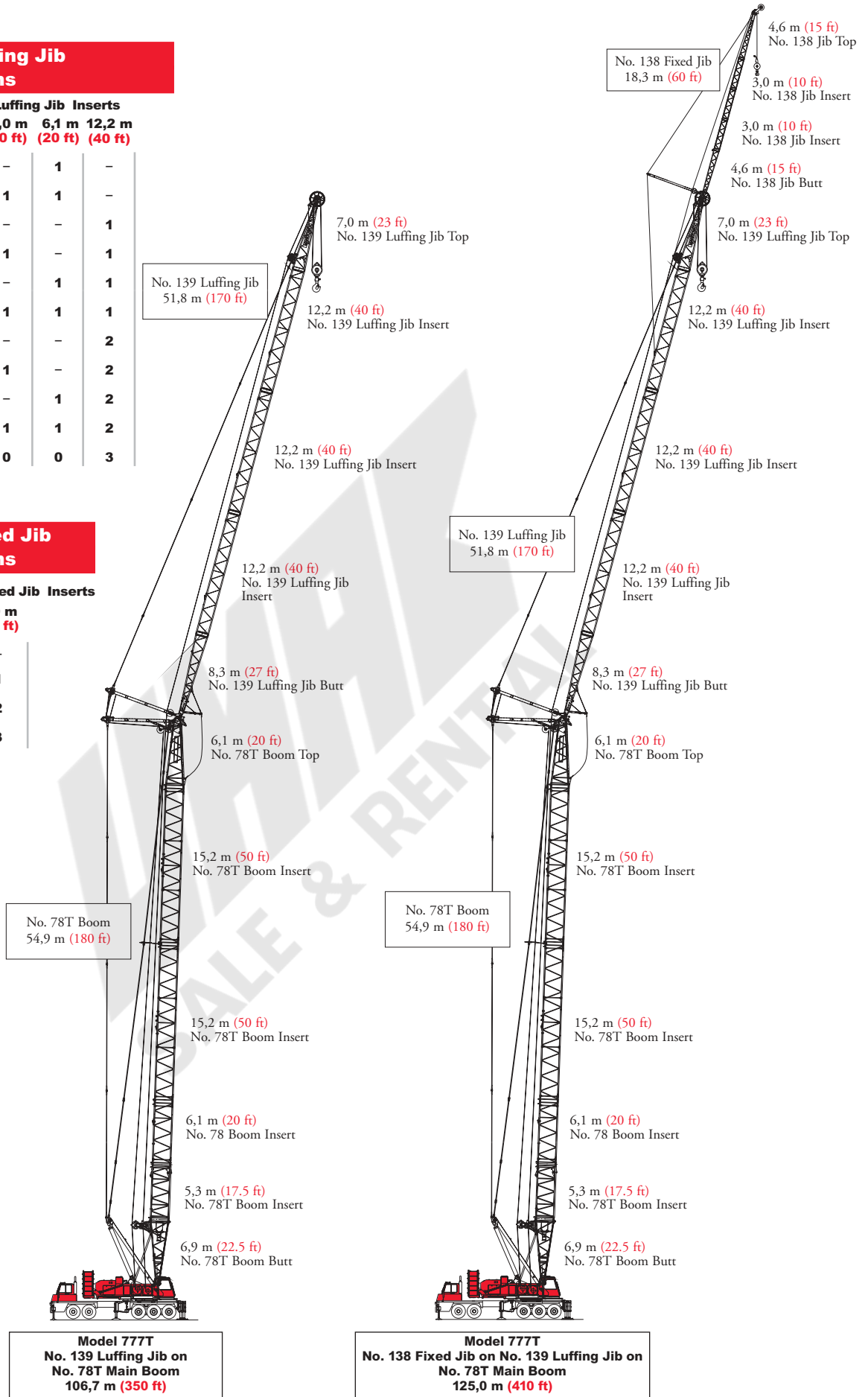

heavy-lift boom range diagram

No. 78T Heavy-Lift Boom

27

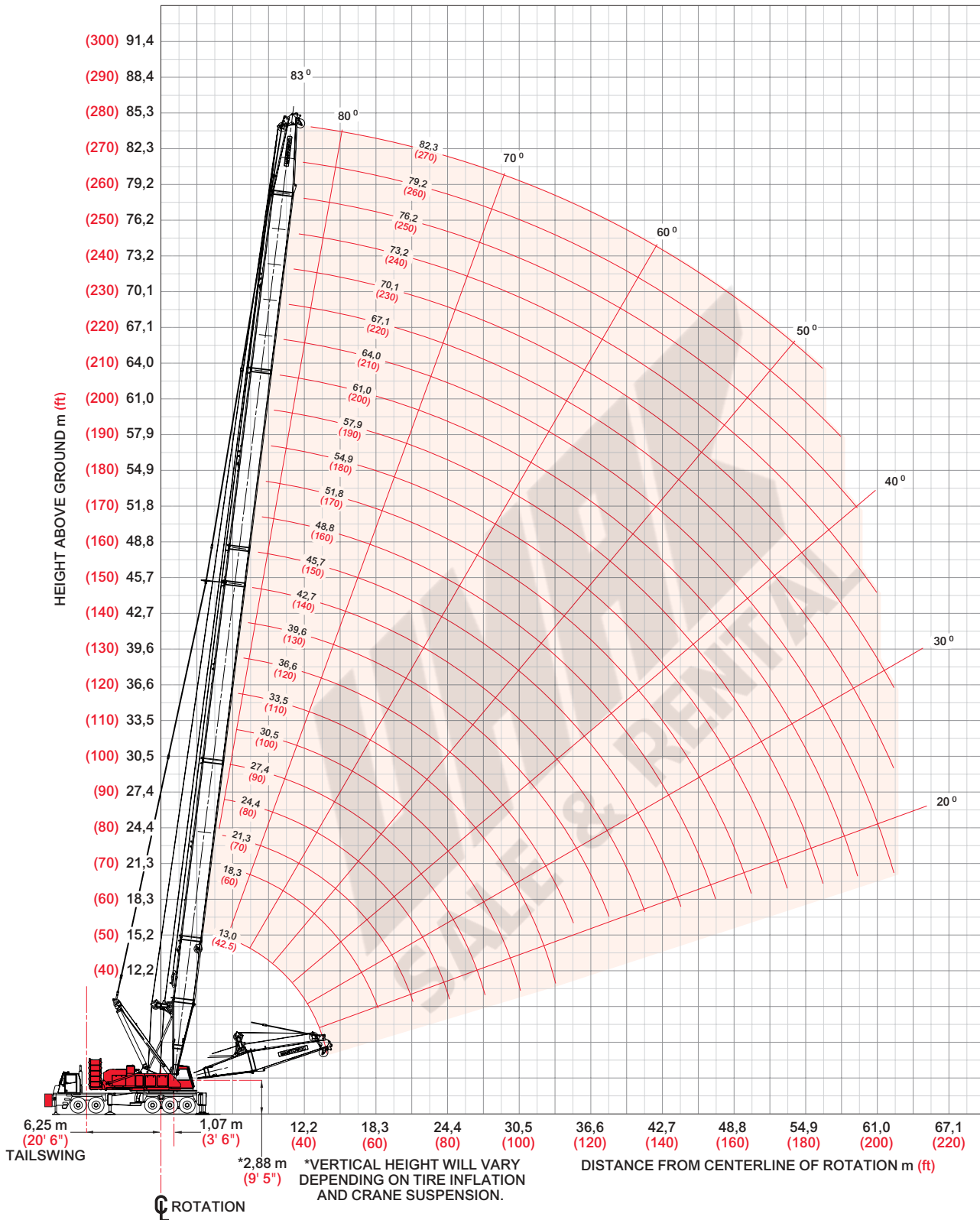

heavy-lift load charts

28

Liftcrane Boom Capacities Boom No. 78T with Heavy Lift Top

95,400 lb Counterweight 25,000 lb Front Bumper Counterweight

360° Rating

lb x 1 000

Boom ft	42.5	70	90	110	130	150	170	190	210	230	250	270
Radius												
12	364.0											
14	354.9											
16	312.8	294.3										
20	252.1	252.1	247.5	208.8								
24	210.4	210.6	210.3	185.8	168.9							
30	165.4	166.2	166.2	158.8	145.7	148.0	142.3	121.1				
40	118.8	120.1	120.1	119.7	115.5	112.0	106.9	101.5	97.7	92.6		
50		92.8	92.8	92.5	92.3	90.7	86.2	81.5	78.7	74.7	71.9	68.7
60		74.6	72.5	74.5	72.7	73.3	71.8	68.1	65.5	61.8	59.0	56.0
70		61.6	57.7	61.7	57.8	60.6	56.9	58.4	55.7	52.5	49.8	47.0
80			47.1	52.1	47.3	51.0	46.3	49.8	45.0	44.5	42.9	40.2
90			39.0	44.7	39.4	43.6	38.4	42.4	37.0	36.5	35.7	34.9
100				38.7	33.3	37.7	32.2	36.5	30.9	30.3	29.5	28.7
110				33.6	28.4	32.8	27.3	31.7	25.9	25.4	24.5	23.7
120					24.3	28.8	23.3	27.6	21.9	21.3	20.5	19.7
130					20.8	25.4	20.0	24.2	18.6	18.0	17.1	16.3
140						22.4	17.1	21.3	15.7	15.1	14.2	13.5
160							12.5	16.5	11.2	10.6	9.7	8.9
180								12.0	7.7	7.1	6.2	5.4
200									4.8	4.3	3.4	2.7
210									3.6	3.1	2.2	
220										2.0	3.6*	
230											2.4*	

* Over rear outriggers only.

heavy-lift load charts

29

Liftcrane Boom Capacities Boom No. 78T with Heavy Lift top on Rubber

44,000 lb Counterweight 24,000 lb Front Bumper Counterweight

360° Rating

lb x 1 000

Boom ft	42.5	60	70	80	90	100	110	120	130	140
Radius										
12	177.1									
14	166.4	161.2								
16	143.6	143.5	144.5	144.7						
18	123.5	123.5	124.5	124.6	124.7	124.6				
20	108.1	108.0	109.0	109.1	109.2	109.1	109.1			
22	95.7	95.7	96.7	96.8	96.9	96.8	96.7	96.9	96.7	
26	77.3	77.3	78.3	78.4	78.5	78.3	78.2	78.4	78.2	77.9
30	64.1	64.2	65.3	65.3	65.4	65.2	65.1	65.3	65.0	64.8
34	54.2	54.4	55.5	55.6	55.6	55.4	55.3	55.5	55.2	55.0
40	43.2	43.6	44.7	44.8	44.8	44.6	44.5	44.7	44.4	44.2
45	35.9	36.9	38.0	38.1	38.1	38.0	37.9	38.0	37.7	37.5
50		31.5	32.7	32.8	32.8	32.7	32.6	32.8	32.5	32.2
60		23.3	24.7	24.9	25.0	24.8	24.7	24.9	24.6	24.4
70			18.9	19.3	19.4	19.3	19.2	19.4	19.1	18.8
80				14.9	15.2	15.1	15.0	15.3	15.0	14.7
90					11.7	11.8	11.8	12.1	11.8	11.5
100						9.1	9.2	9.5	9.2	9.0
110							6.9	7.3	7.1	6.9
120								5.4	5.3	5.1
130									3.7	3.6
140										2.2

Meets ANSI B30.5 Requirements - Capacities do not exceed 75% of static tipping load.
NOTICE: This capacity chart is for reference only and must not be used for lifting purposes.

heavy-lift load charts

30

Liftcrane Boom Capacities Boom No. 78T with Heavy Lift Top on Rolling Outriggers

44,000 lb Counterweight 24,000 lb Front Bumper Counterweight

360° Rating

lb x 1 000

Boom ft	42.5	60	70	80	90	100	110	120	130	140	150
Radius											
12	364.0										
14	354.9	353.7									
16	312.8	311.8	294.3	280.6							
18	279.4	278.5	279.3	276.5	265.3	241.2					
20	252.1	251.3	252.1	252.0	247.5	225.8	208.8				
22	229.5	228.8	229.6	229.4	229.3	211.9	196.7	189.7	178.1		
26	194.1	193.5	194.0	194.3	194.1	188.7	176.0	169.0	160.5	153.3	161.1
30	153.3	154.7	156.0	156.5	156.9	157.1	157.3	152.0	145.7	138.7	148.0
34	124.1	125.3	126.6	127.0	127.3	127.5	127.7	127.9	128.0	126.2	128.0
40	95.5	96.7	97.9	98.3	98.5	98.6	98.7	99.0	99.0	98.9	98.8
45	79.1	80.7	81.9	82.2	82.4	82.5	82.5	82.8	82.7	82.6	82.4
50		68.8	70.0	70.2	70.4	70.5	70.5	70.8	70.7	70.6	70.3
60		52.0	53.4	53.7	53.9	53.9	53.9	54.2	54.0	53.9	53.6
70			42.3	42.7	43.0	43.0	43.0	43.2	43.1	42.9	42.6
80				34.8	35.2	35.2	35.2	35.4	35.3	35.1	34.8
90					29.2	29.3	29.4	29.6	29.5	29.3	28.9
100						24.7	24.8	25.1	24.9	24.8	24.4
110							21.1	21.4	21.3	21.2	20.8
120								18.4	18.3	18.2	17.8
130									15.8	15.7	15.3
140										13.5	13.2
145											12.2
150											11.3

long-reach boom range diagram

No. 78T Long Reach Boom

31

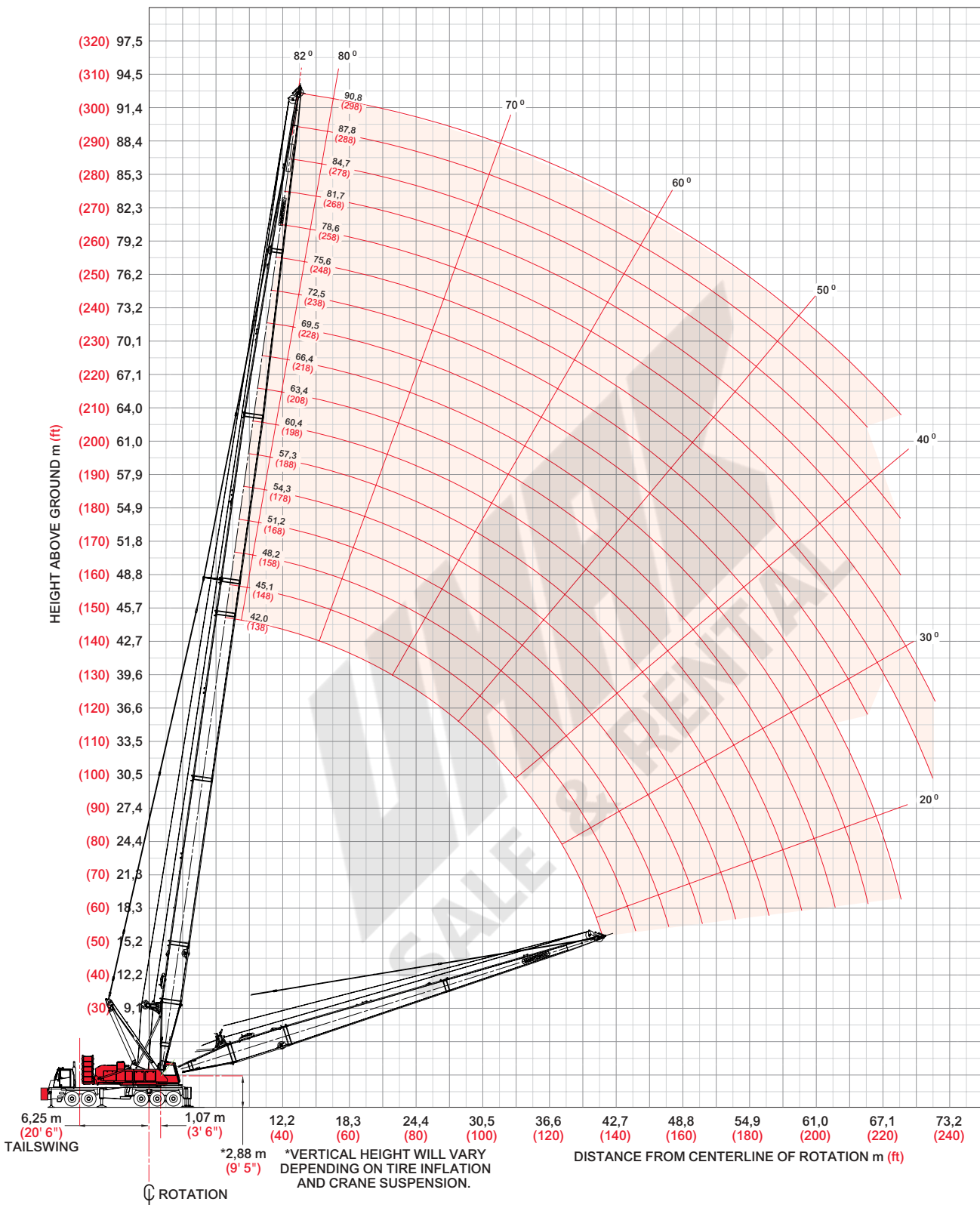

long-reach load charts

32

Liftcrane Boom Capacities Boom No. 78T with Long Reach Top

95,400 lb Counterweight 24,000 lb Front Bumper Counterweight

360° Rating

lb x 1 000

Boom ft	138	148	168	178	198	208	228	238	258	268	288	298
Radius												
24	146.2	141.6										
26	140.7	136.2										
30	130.6	126.3	144.1	124.1								
34	121.5	117.4	133.9	117.6	111.8	108.6						
40	109.5	105.5	113.9	108.5	104.4	101.8	86.2	77.9	77.4			
50	93.0	89.4	91.8	89.3	85.8	83.8	76.1	68.2	72.0	68.3	61.0	
60	74.3	74.1	73.4	73.1	71.6	69.7	66.2	59.7	62.3	60.8	55.6	53.7
70	59.6	59.4	58.7	58.3	57.9	57.5	56.4	52.3	52.6	51.2	48.6	46.4
80	49.2	49.0	48.2	47.8	47.4	47.0	46.2	45.8	45.3	44.1	41.5	39.7
90	41.4	41.2	40.4	40.0	39.5	39.1	38.3	37.9	37.3	36.9	36.0	34.4
100	35.4	35.1	34.3	33.9	33.4	33.0	32.2	31.8	31.2	30.8	29.9	29.9
110	30.6	30.3	29.4	29.0	28.6	28.1	27.3	26.9	26.3	25.9	25.0	25.0
120	26.6	26.3	25.5	25.1	24.6	24.2	23.3	22.9	22.3	21.9	21.0	21.0
130	23.2	23.0	22.2	21.8	21.3	20.9	20.0	19.6	19.0	18.6	17.7	17.7
140		20.2	19.4	19.0	18.5	18.1	17.2	16.8	16.2	15.8	14.8	14.8
160			14.8	14.4	14.0	13.6	12.7	12.3	11.7	11.2	10.3	10.3
180					10.5	10.1	9.3	8.9	8.2	7.8	6.9	6.9
190					9.1	8.7	7.8	6.9	6.8	6.4	5.4	5.4
200						7.3	6.5	4.9	5.5	5.1	4.1	4.1
210							5.3	3.2	4.4	3.9	3.0	3.0
220								3.9	3.3	2.1		3.1*
230									2.3			
235										2.8*		

* Over rear outriggers only.

fixed jib range diagram

No. 138 Fixed Jib on Boom No. 78T with Heavy Lift Top

33

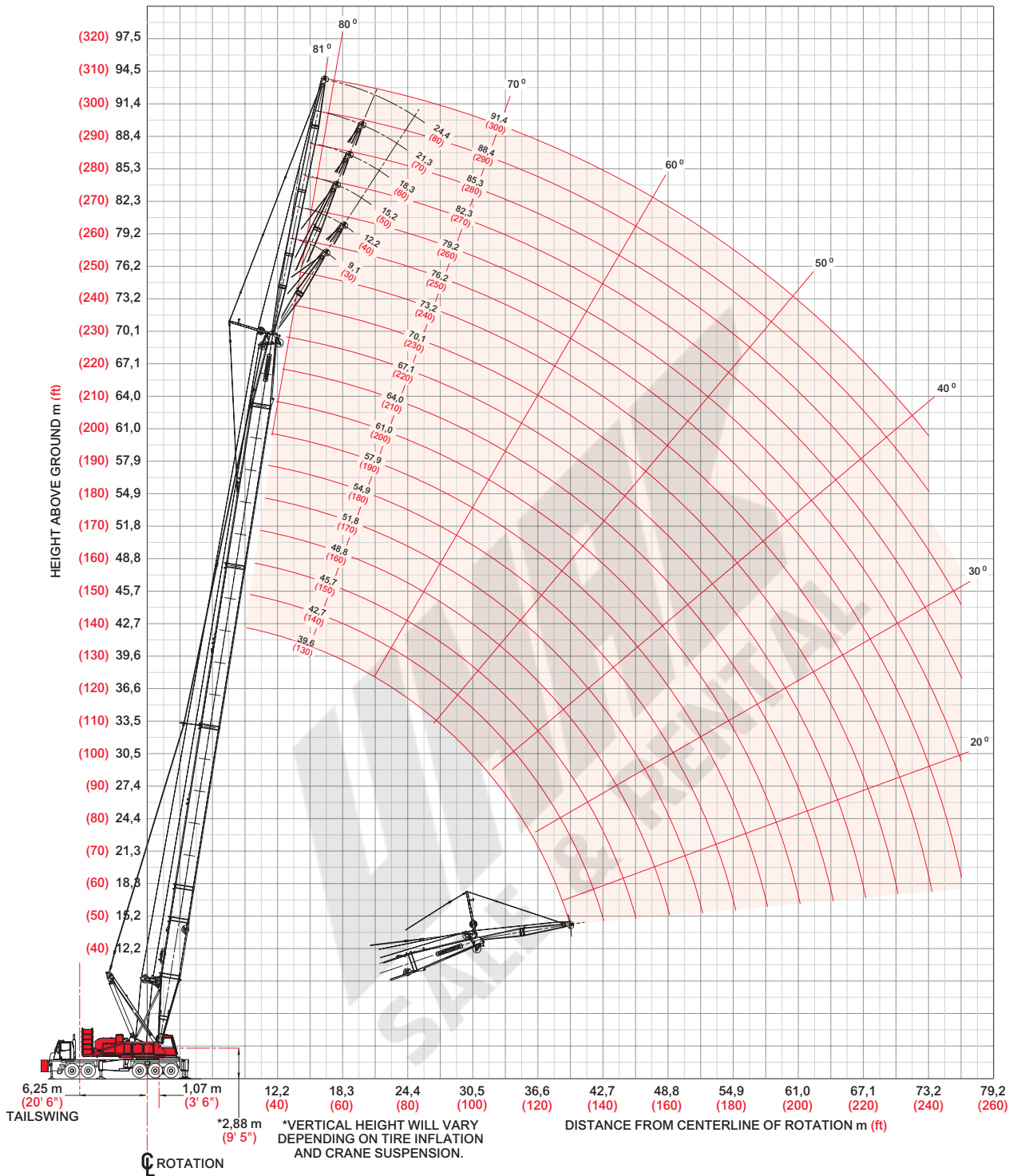

fixed jib load charts

35

Liftcrane Jib Capacities Jib No. 134 with (12'6") Strut on Boom No. 78T with Heavy Lift Top

95,400 lb Counterweight 25,000 lb Front Bumper Counterweight
00' 0" Crawlers extended
360° Rating lb x 1 000

		5' Offset					25' Offset					
		100	130	160	190	220	Boom ft	100	130	160	190	220
Jib 60 ft	Radius											
	35	36.0					60	26.4				
	40	35.1	36.0				65	25.1	26.5	27.4		
	50	33.4	34.5	35.3	36.0		80	21.9	23.5	24.8	25.8	25.6
	70	30.5	31.9	32.9	33.8	33.6	100	18.8	20.4	21.8	22.9	22.8
	100	26.7	28.4	29.8	30.9	28.2	120	16.6	18.2	19.5	20.5	17.9
	130	22.6	23.1	21.4	20.4	18.7	140	15.1	16.5	17.4	16.5	14.1
	160	16.4	15.6	14.1	13.0	11.8	160		15.2	14.3	13.3	11.2
	190		10.5	9.1	7.9	6.8	180		12.5	11.5	10.7	8.8
	210			6.5	5.4	4.3	210				6.2	5.4
240				2.4		240					2.0	
250						250						

		5' Offset					25' Offset					
		100	130	160	190	220	Boom ft	100	130	160	190	220
Jib 80 ft	Radius											
	35						60					
	40	20.6					65	17.4				
	50	20.3	20.5	20.6			80	16.4	16.8	17.1	17.4	
	70	19.7	19.9	20.1	20.3	21.6	100	14.9	15.7	16.1	16.4	17.6
	100	17.5	18.6	19.5	19.7	20.7	120	12.8	14.0	15.0	15.6	16.3
	130	15.3	16.5	17.5	18.4	17.6	140	11.3	12.4	13.5	14.4	12.9
	160	13.5	14.7	14.6	13.3	11.9	160	10.2	11.2	12.2	12.6	10.2
	190		11.1	9.6	8.3	7.1	180		10.3	11.2	10.2	8.0
	210		8.6	7.1	5.8	4.6	210			7.9	7.0	5.4
240			4.0	2.9		240				3.6	2.7	
250				2.0		250				2.6		

Meets ANSI B30.5 Requirements - Capacities do not exceed 75% of static tipping load.
NOTICE: This capacity chart is for reference only and must not be used for lifting purposes.



fixed jib range diagram

No. 138 Fixed Jib on Boom No. 78T with Long Reach Top

36

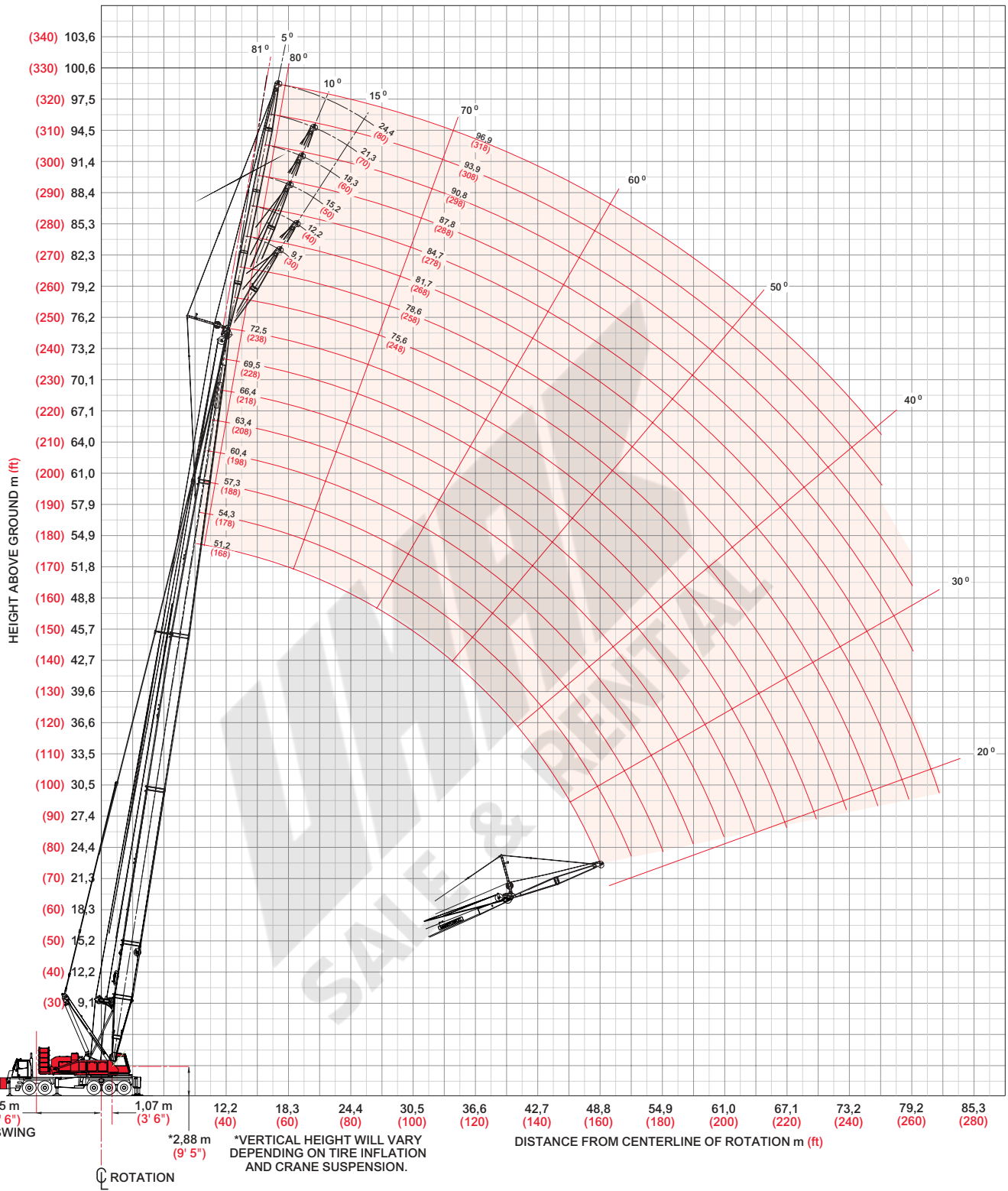

fixed jib load charts

37

Liftcrane Jib Capacities Jib No. 134 with 12'6" Strut on Boom No. 78T with Long Reach Top

95,400 lb Counterweight 25,000 lb Front Bumper Counterweight
00' 0" Crawlers extended
360° Rating lb x 1 000

		5' Offset					25' Offset				
		138	168	198	238	268	138	168	198	238	268
Jib 30 ft	Boom ft										
	Radius										
	35	59.0					45.0				
	45	59.0	59.0	59.0			43.3	44.9			
	55	59.0	59.0	59.0	58.8	48.6	40.3	41.2	40.3	42.0	
	70	55.3	49.6	50.3	54.0	44.4	37.8	38.1	37.4	39.5	34.0
	90	41.9	40.7	39.7	38.1	36.9	33.8	33.1	32.7	35.5	29.9
	120	26.9	25.6	24.6	22.8	21.7	27.6	26.5	25.6	24.2	23.2
	150	18.3	17.0	15.9	14.2	13.0		17.5	16.6	15.1	14.1
	180		11.3	10.3	8.5	7.4			10.8	9.2	8.2
	210			6.4	4.6	3.5				5.0	4.0
230				2.2							
240											

		138	168	198	238	248	138	168	198	238	248	
Jib 50 ft	Boom ft											
	Radius											
	35						45					
	45	45.5	45.4				50					
	55	43.7	43.8	43.4	41.4		60	28.3				
	70	40.8	37.8	38.1	38.8	36.0	70	26.5	27.4	27.5		
	90	34.0	31.2	31.6	35.2	30.0	90	23.6	24.7	24.2	25.4	22.1
	120	27.4	24.7	25.1	23.6	23.4	120	20.5	20.9	20.5	22.2	18.8
	150	19.0	17.7	16.6	14.8	14.6	150	18.5	18.3	17.9	16.5	16.3
	180	13.3	12.0	10.9	9.1	8.9	180		12.7	11.8	10.3	10.1
	210		7.9	6.9	5.1	4.9	210				6.0	5.8
230			4.8	3.1	2.8	230				3.7	3.5	
240			3.9	2.1		240				2.7	2.5	

Meets ANSI B30.5 Requirements - Capacities do not exceed 75% of static tipping load.
NOTICE: This capacity chart is for reference only and must not be used for lifting purposes.



luffing jib range diagram

No. 139 Luffing Jib on No. 78T Heavy-Lift Boom

39

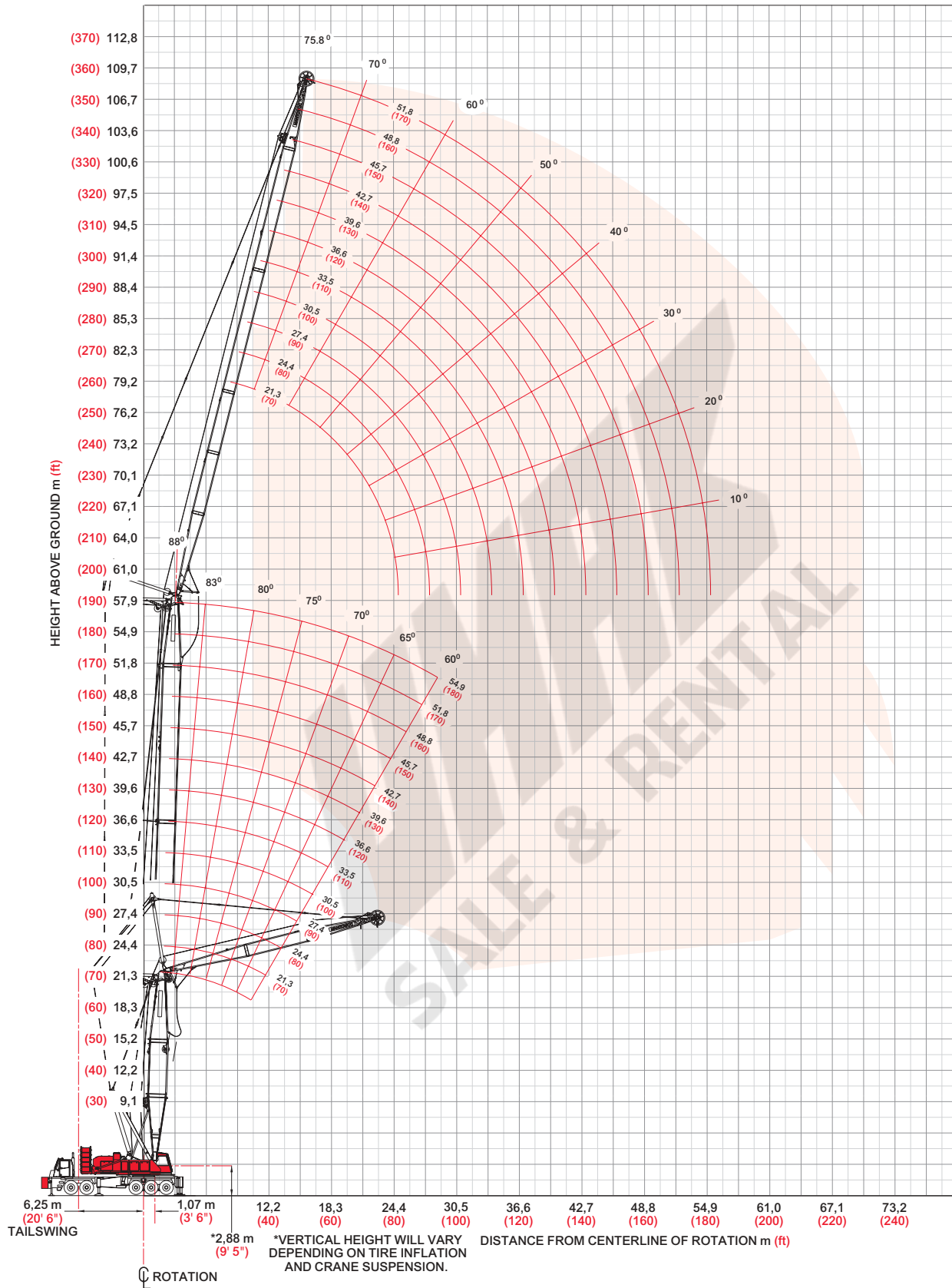

model 777T



luffing jib load charts

40

Liftcrane Luffing Jib Capacities Luffing Jib No. 139 on Boom No. 78T with Heavy Lift Top

95,400 lb Counterweight 25,000 lb Carbody Counterweight

360° Rating

lb x 1 000

88° Boom Angle

Luffing Jib Length	70 ft	Boom ft					Luffing Jib Length	100 ft	Boom ft				
	Radius	60	90	130	150	180		Radius	60	90	130	150	180
30	105.0	103.9				30							
35	100.3	99.3	93.4	90.1		35	77.1	75.6	72.1	69.3			
40	94.7	94.1	89.5	88.0	75.5	40	73.3	72.7	69.9	67.7	50.3		
50	73.0	75.3	78.4	78.0	67.5	50	66.2	66.1	65.3	63.9	48.4		
60	57.3	58.9	61.0	62.1	60.6	60	57.8	59.4	60.1	59.4	46.6		
70	46.4	47.6	49.1	49.9	51.3	70	47.0	48.2	49.7	50.4	45.1		
80					36.2	80	39.3	40.1	41.3	41.8	40.8		
90						90	33.3	34.0	34.9	35.3	36.2		
100						100	28.5	29.0	29.8	30.1	30.9		
110						110					23.5		

Luffing Jib Length	130 ft	Boom ft					Luffing Jib Length	170 ft	Boom ft				
	Radius	60	90	130	150	180		Radius	60	90	130	150	180
40	50.8	49.3				40							
50	48.6	47.3	45.1	43.7	41.3	50	35.9	35.3					
60	44.9	44.8	43.6	42.4	39.9	60	32.5	32.3	31.8	31.3	27.6		
80	37.5	37.7	37.8	37.6	34.6	80	26.3	26.4	26.5	26.3	23.5		
100	28.8	29.3	30.1	30.4	29.2	100	21.0	21.3	21.6	21.6	19.4		
120	21.8	22.2	22.7	23.0	23.3	120	16.8	17.0	17.4	17.5	15.9		
140					15.8	140	13.3	13.6	13.9	14.0	12.9		
160						160	10.2	10.5	10.8	11.0	9.9		
170						170	8.7	8.9	9.2	9.4	8.5		
180						180					7.3		

Luffing jib load charts

Liftcrane Luffing Jib Capacities Luffing Jib No. 139 on Boom No. 78T with Heavy Lift Top

95,400 lb Counterweight 25,000 lb Carbody Counterweight
360° Rating lb x 1 000

60° Boom Angle

41

Luffing Jib Length	Boom ft					Luffing Jib Length	Boom ft						
	60	90	130	150	180		60	90	130	150	180		
70 ft	45.2					100 ft							
85	42.0					110	31.3						
90	36.6	33.2				120	27.9	24.9					
100		29.3				130	24.9	22.3					
110		26.0	21.8			140		20.0	16.3				
120			19.5	16.7		160			13.2	10.9			
130			17.5	15.0		180				8.7	5.9		
140					9.0	190						5.2	
160													
180													
190													

Luffing Jib Length	Boom ft					Luffing Jib Length	Boom ft						
	60	90	130	150	180		60	90	130	150	180		
130 ft						170 ft							
125						180							
130	24.3					190	10.0	10.7	7.8				
140	21.9	19.2				210		8.8	6.2	4.3			
150	19.8	17.4				230			4.9				
160	17.9	15.7	12.3			240			4.3				
170		14.3	11.1	8.9									
190			9.1	7.1									
210				5.6									
230													
240													

Meets ANSI B30.5 Requirements - Capacities do not exceed 75% of static tipping load.
NOTICE: This capacity chart is for reference only and must not be used for lifting purposes.

luffing jib load charts

42

Liftcrane Luffing Jib Capacities Luffing Jib No. 139 on Boom No. 78T with Heavy Lift Top

95,400 lb Counterweight 25,000 lb Carbody Counterweight

360° Rating

lb x 1 000

60° Boom Angle

Luffing Jib Length	Boom ft					Luffing Jib Length	Boom ft					
	60	90	130	150	180		60	90	130	150	180	
70 ft	85	45.2				100 ft	85					
	90	42.0					90					
	100	36.6	33.2				100					
	110		29.3				110	31.3				
	120		26.0	21.8			120	27.9	24.9			
	130			19.5	16.7		130	24.9	22.3			
	140			17.5	15.0		140		20.0	16.3		
	160						160			13.2	10.9	
	180						180				8.7	5.9
	190				9.0		190					5.2

Luffing Jib Length	Boom ft					Luffing Jib Length	Boom ft				
	60	90	130	150	180		60	90	130	150	180
130 ft	125					170 ft	125				
	130	24.3					130				
	140	21.9	19.2				140				
	150	19.8	17.4				150	16.3			
	160	17.9	15.7	12.3			160	14.6			
	170		14.3	11.1	8.9		170	13.1	13.1		
	190			9.1	7.1		190	10.0	10.7	7.8	
	210				5.6		210		8.8	6.2	4.3
	230						230			4.9	
	240						240			4.3	

fixed jib on luffing jib range diagram

No. 138 Fixed Jib on No. 139 Luffing Jib on No. 77T Heavy-Lift Boom

43

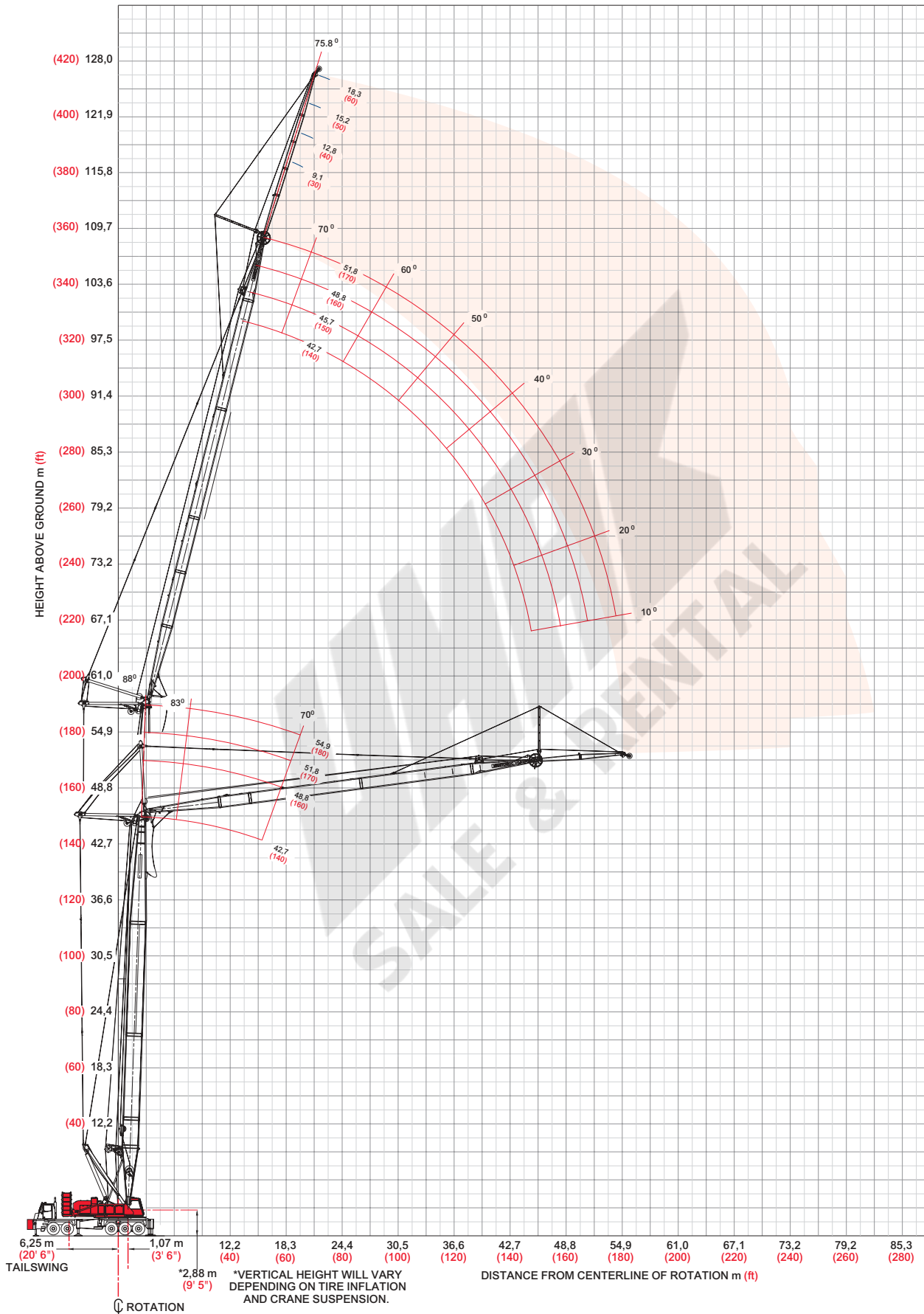

fixed jib on luffing jib load charts

44

Liftcrane Fixed Jib on Luffing Capacities - Series 2

Fixed Jib No. 138 at 3 Degree Angle on Luffing Jib No. 139 on Boom No. 78T

64 410 kg (142,000 lb) Upperworks Counterweight 19 960 kg (44,000 lb) Carbody Counterweight

360° Rating

lb x 1 000

88° Boom Angle

Luffing Jib ft	140			150			160			170			
	Boom ft	140	160	180	140	160	180	140	160	180	140	160	180
Fixed Jib Length 30 ft	Radius												
	55	27.0	26.6										
	65	26.5	26.1	25.6	25.9	24.9	23.5	23.3	22.3	21.3	20.9	20.0	19.1
	80	25.7	25.4	24.3	25.1	24.1	22.5	22.5	21.6	20.6	20.1	19.3	18.4
	100	21.9	22.0	21.5	21.5	21.5	20.2	21.0	20.2	18.7	19.0	18.3	17.3
	120	19.1	19.2	18.6	18.8	18.8	17.7	18.5	18.0	16.7	17.8	16.8	15.6
	140	16.9	17.0	15.7	16.7	16.5	15.2	16.5	15.8	14.6	16.0	15.0	13.8
	160	14.2	14.2	13.2	14.1	14.0	13.0	13.9	13.7	12.6	13.6	13.1	12.1
	180	9.7	10.0	10.3	11.1	11.2	11.0	10.9	11.0	10.8	10.7	10.8	10.6
	200							7.2	7.5	7.7	8.2	8.3	8.4
210										6.1	6.3	6.5	

Luffing Jib ft	140			150			160			170			
	Boom ft	140	160	180	140	160	180	140	160	180	140	160	180
Fixed Jib Length 60 ft	Radius												
	65	15.7	15.4	15.1	15.1	14.8							
	80	14.8	14.6	14.3	14.3	14.0	13.7	13.7	13.4	13.0	12.9	12.6	12.3
	100	13.6	13.5	13.3	13.2	13.0	12.8	12.7	12.5	12.2	12.1	11.9	11.6
	120	12.6	12.5	12.4	12.3	12.2	12.0	11.9	11.7	11.5	11.4	11.2	10.9
	140	11.2	11.3	11.4	11.0	11.1	11.2	10.9	10.9	10.9	10.6	10.6	10.4
	160	9.9	10.0	10.1	9.8	9.8	9.9	9.6	9.7	9.7	9.4	9.5	9.5
	180	8.9	9.0	9.0	8.8	8.8	8.9	8.7	8.7	8.8	8.5	8.6	8.6
	200	8.1	8.2	8.1	8.0	8.1	8.1	7.9	7.9	8.0	7.8	7.8	7.8
	220				6.4	6.7	6.9	7.3	7.3	7.0	7.1	7.2	6.9
240										4.4	4.7	4.8	

fixed jib on luffing jib load charts

45

Liftcrane Fixed Jib on Luffing Capacities - Series 2

Fixed Jib No. 138 at 3 Degree Angle on Luffing Jib No. 139 on Boom No. 78T

64 410 kg (142,000 lb) Upperworks Counterweight 19 960 kg (44,000 lb) Carbody Counterweight

360° Rating

lb x 1 000

83° Boom Angle

Fixed Jib Length 30 ft	Luffing Jib ft 140			150			160			170			
	Boom ft	140	160	180	140	160	180	140	160	180	140	160	180
	Radius												
80	26.4												
90	26.0	25.7	24.6	24.5	23.4	22.0	21.7	20.7			19.3		
100	24.5	25.0	24.2	23.9	23.1	21.9	21.4	20.5	19.5		19.0	18.2	17.4
120	21.0	21.5	21.9	20.6	21.0	21.4	20.2	19.9	19.0		18.2	17.6	16.9
140	18.4	18.8	17.8	18.1	18.5	17.5	17.8	18.1	17.1		17.2	17.0	16.4
160	16.4	15.4	14.3	16.2	15.2	14.1	15.8	14.7	13.7		15.4	14.4	13.3
180	13.0	12.6	11.7	13.0	12.4	11.5	12.7	12.0	11.0		12.5	11.6	10.7
200				10.1	10.2	9.4	10.0	9.8	8.9		9.8	9.4	8.6
210							8.7	8.8	8.1		8.6	8.5	7.7
220											7.4	7.6	6.9

Fixed Jib Length 60 ft	Luffing Jib ft 140			150			160			170			
	Boom ft	140	160	180	140	160	180	140	160	180	140	160	180
	Radius												
95	14.3	14.1		13.8									
105	13.8	13.7	13.5	13.3	13.2	12.9	12.7	12.5	12.2		12.0	11.8	
120	13.1	13.0	12.9	12.7	12.6	12.4	12.2	12.0	11.8		11.6	11.4	11.1
140	12.2	12.2	12.1	11.9	11.8	11.7	11.5	11.4	11.2		11.0	10.8	10.6
160	10.8	11.0	11.3	10.6	10.9	11.1	10.5	10.7	10.7		10.2	10.3	10.2
180	9.6	9.8	10.0	9.5	9.7	9.8	9.3	9.5	9.7		9.2	9.3	9.5
200	8.7	8.8	9.0	8.6	8.7	8.9	8.4	8.6	8.7		8.3	8.4	8.5
220	8.0	8.1	8.2	7.8	7.9	8.1	7.7	7.8	7.6		7.6	7.7	7.3
240							6.7	6.9	6.2		6.5	6.6	5.8
250											5.6	5.9	5.2

Meets ANSI B30.5 Requirements - Capacities do not exceed 75% of static tipping load.
 NOTICE: This capacity chart is for reference only and must not be used for lifting purposes.

fixed jib on luffing jib load charts

46

Liftcrane Fixed Jib on Luffing Capacities - Series 2

Fixed Jib No. 138 at 3 Degree Angle on Luffing Jib No. 139 on Boom No. 78T

64 410 kg (142,000 lb) Upperworks Counterweight 19 960 kg (44,000 lb) Carbody Counterweight

360° Rating

lb x 1 000

70° Boom Angle

Luffing Jib ft	140			150			160			170			
	Boom ft	140	160	180	140	160	180	140	160	180	140	160	180
Radius													
Fixed Jib Length 30 ft	150	13.6											
	160	12.2	11.0	9.3	12.1	10.9		11.7					
	170	11.1	10.0	8.5	10.9	9.8	8.2	10.6	9.4		10.3	9.1	
	180	10.0	9.0	7.8	9.9	8.8	7.5	9.5	8.5	7.0	9.2	8.2	6.7
	190	9.1	8.1	7.0	9.0	8.0	6.9	8.6	7.6	6.3	8.3	7.3	6.1
	200	8.3	7.3	6.3	8.2	7.2	6.2	7.8	6.8	5.7	7.5	6.5	5.4
	210	7.5	6.6	5.7	7.4	6.5	5.5	7.0	6.1	5.1	6.8	5.9	4.8
	220	6.8	6.0	5.1	6.7	5.9	4.9	6.4	5.5	4.6	6.1	5.2	4.3
	240					4.7		5.1	4.4		4.9	4.1	
	250										4.4		

Luffing Jib ft	140			150			160			170			
	Boom ft	140	160	180	140	160	180	140	160	180	140	160	180
Radius													
Fixed Jib Length 60 ft	165	11.8											
	170	11.2	10.1		11.1								
	180	10.2	9.1	7.5	10.1	9.0		9.7			9.4		
	190	9.3	8.3	6.9	9.2	8.1	6.6	8.8	7.7	6.1	8.5	7.4	
	200	8.5	7.5	6.3	8.3	7.4	6.1	8.0	7.0	5.6	7.7	6.7	5.3
	210	7.8	6.8	5.8	7.6	6.7	5.5	7.2	6.3	5.1	7.0	6.0	4.8
	220	7.1	6.2	5.2	6.9	6.1	5.0	6.6	5.7	4.5	6.3	5.4	4.3
	240	5.9	5.1	4.2	5.8	5.0	4.0	5.4	4.6		5.1	4.3	
	260		4.1		4.7	4.0		4.4			4.2		
	270							4.0					

Meets ANSI B30.5 Requirements - Capacities do not exceed 75% of static tipping load.
 NOTICE: This capacity chart is for reference only and must not be used for lifting purposes.

CraneCARE is Manitowoc's comprehensive service and support program. It includes classroom and on-site training, prompt parts availability, expert field service, technical support and documentation — for every one of the more than 7,000 Manitowoc cranes currently in use throughout the world.

That's commitment you won't find anywhere else.

That's **CraneCARE**.

Service Training

Manitowoc specialists work with you in our training center and in the field to make sure you know how to get maximum performance, reliability, and life from your cranes.

Manitowoc Cranes Technical Training Center provides valuable multi-level training, which is available for all models and attachments, in the following format:

- **Basic** – Provides technicians with the basic skills required in our Level I and II classes covering hydraulic and electrical theory and schematics, pump, motor, control, and LMI operation, and the use of meters and gauges.
- **Level 1** – This model-specific class covers theory and offers hands-on training and trouble shooting for all crane systems.
- **Level 2** – This model-specific class provides in depth coverage of all crane systems and components, and advanced troubleshooting of simulated faults. (Requires Level 1.)
- **Level 3/Masters** – Covering all EPIC models and the 4100W, this class stresses high level system knowledge and trouble shooting of simulated faults. (Requires Level 2.)

Parts Availability

Genuine Manitowoc replacement parts are accessible through your distributor 24 hours a day, 7 days a week, 365 days a year.

Service Interval Kits

Provides all the parts required by Manitowoc's Preventative Maintenance Checklist.

Hydraulic Filter Kit – Part No. 495138-0

Consists of the following:

- Filter Element - No substitutions allowed (1x Part No. 427283-0)
- Filter Element (1x Part No. 427292-0)
- Filter Element (Spin on) - No substitutions allowed (1x Part No. 427282-0)

Cummins Model QSC8.3 – C340 Diesel – Part No. 414176-0 Service Interval Kits

200 Hour Kit – Part No. 495198-0

Consists of the following:

Engine

- Air Cleaner - Disposable (1x Part No. 347066-0)
- Oil Filter (1x Part No. 413653-0)
- Water Filter (1x Part No. 413654-0)
- Separator - Fuel/Water (1x Part No. 413652-0)

1,000 Hour Kit – Part No. 495199-0

Consists of the following:

Engine

- Air Cleaner - Disposable (1x Part No. 347066-0)
- Oil Filter (1x Part No. 413653-0)
- Water Filter (1x Part No. 413654-0)
- Separator - Fuel/Water (1x Part No. 413652-0)

Hydraulic

- Filter Element - No substitutions allowed (1x Part No. 427283-0)
- Filter Element (1x Part No. 427292-0)
- Filter Element (Spin on) - No substitutions allowed (1x Part No. 427282-0)

2,000 Hour Kit – Part No. 495202-0

Consists of the following:

Engine

- Air Cleaner - Disposable (1x Part No. 347066-0)
- Oil Filter (1x Part No. 413653-0)
- Water Filter (1x Part No. 413654-0)
- Separator - Fuel/Water (1x Part No. 413652-0)
- Belt - Alternator & Fan (1x Part No. 413650-0)
- Belt - Compressor (1x Part No. 413651-0)

Hydraulic

- Filter Element - No substitutions allowed (1x Part No. 427283-0)
- Filter Element (1x Part No. 427292-0)
- Filter Element (Spin on) - No substitutions allowed (1x Part No. 427282-0)
- Filter Element (Spin on) - Hydraulic (3x Part No. 427278-0)
- Filter Element (Spin on) - Hydraulic (1x Part No. 427291-0)
- Filter Element (Spin on) - Hydraulic (1x Part No. 427279-0)

Hydraulic Test Kit – Part No. 499791-6

Protect your investment by demanding Genuine Manitowoc Parts Service Kits. The Hydraulic Service Kit consist of the following:

- All hydraulic fittings to access all pressures and flows
- Hydraulic flow meters and pressure gauges to record hydraulic data.
- Electrical “Break out” harnesses to access voltages on all electrical circuits on all machines.
- Fluke® Digital volt ohm meter, as used in all Manitowoc service literature.

Hydraulic Test Kit with case – Part No. 499792-9

The above kit (Part No. 4299791-6) plus a custom heavy-duty carrying case.

U.S. Standard Tools Kit – Part No. 22205-1

All standard tools needed to properly maintain and service your crane. (Does not include torque wrench.)

Carrier Engine Service Kits

Hydraulic Filter Kit – Part No. 495153-0

Consists of the following:

- Filter Element (Spin on) - No substitutions allowed (2x Part No. 427282-0)

Detroit Diesel Series 60– Part No. 414167-0 Service Interval Kits

200 Hour Kit – Part No. 495154-0

Consists of the following:

Engine

- Air Cleaner - Disposable (1x Part No. 347066-0)
- Oil Filter (1x Part No. 413644-0)
- Fuel Filter (1x Part No. 413643-0)

1,000 Hour Kit – Part No. 495155-0

Consists of the following:

Engine

- Air Cleaner - Disposable (1x Part No. 347066-0)
- Oil Filter (1x Part No. 413644-0)
- Fuel Filter (1x Part No. 413643-0)

Hydraulic

- Filter Element (Spin on) - No substitutions allowed (2x Part No. 427282-0)

2,000 Hour Kit – Part No. 495156-0

Consists of the following:

Engine

- Air Cleaner - Disposable (1x Part No. 347066-0)
- Oil Filter (1x Part No. 413644-0)
- Fuel Filter (1x Part No. 413643-0)
- Fuel Filter Strainer (1x Part number not assigned)
- Belt - Fan - set of two (1x Part No. 413641-0)
- Belt - Alternator - set of two (1x Part No. 413642-0)

Hydraulic

- Filter Element (Spin on) - No substitutions allowed (2x Part No. 427282-0)

Field Service

Factory-trained service experts are always ready to help maintain your crane's peak performance.

For a worldwide listing of dealer locations, please consult our website at: www.manitowoccrane.com

Technical Support

Manitowoc's dealer network and factory personnel are available 24 hours a day, 7 days a week, 365 days a year to answer your technical questions and more, with the help of computerized programs that simplify crane selection, lift planning, and ground-bearing calculations.

For a worldwide listing of dealer locations, please consult our website at: www.manitowoccrane.com

Technical Documentation

Manitowoc has the industry's most extensive documentation, and the easiest to understand, available in major languages and formats that include print, disk, and videotape.

A complete set of Operator's, Parts, Capacity, Vendor, and Service Technician's Manuals are shipped with each crane.

Additional copies available through your Authorized Manitowoc Distributor.

- **Crane Operator's Manual – Part No. 899721**
- **Crane Parts Manual – Part No. 899720**
- **Crane Capacity Chart Manual – Part No. 899794**
- **Attachment Capacity Chart Manual – Part No. 899795**
- **Crane Vendor Manual – Part No. 899722**
- **Service Technician's Manual (EPIC) – Part No. 899732**

CD rom versions of the Operator's and Parts Manuals are shipped with each crane.

Also available are the following CDs:

- **777T Service – Yearly subscription CD – Part No. 899760-0**
- **Ground Bearing Pressure Estimator CD – Part No. 899765-0**
- **Crane Selection and Planning Software (CompuCRANE®) CD – Part No. 899766-0**

- **EPIC® Crane Library** consisting of capacity charts, range diagrams, wire rope specifications, travel specifications, crane weights, counter weight arrangement, luffing jib raising procedures, operating range diagrams, drum and lagging charts, and wind condition charts.

CD – Part No. 899801-0

Available from your Authorized Manitowoc Cranes Distributor, these VHS videos are available in NTSC, PAL and SECAM formats.

- **Model 777T Assembly Video – Part No. 899826-0**
- **Model 777T Operation Video – Part No. 899827-0**
- **Model 777T Lubrication Video – Part No. 899828-0**
- **Your Capacity Chart Video – Part No. 899737**
- **Respect the Limits Video – Part No. 899734**
- **Crane Safety Video – Part No. 899736**
- **Boom Inspection/Repair Video – Part No. 899738**

CraneCARE Package

Manitowoc has assembled all of the available literature, CDs, and videos listed above plus several Manitowoc premiums into one complete CraneCARE Package.



Notes

50

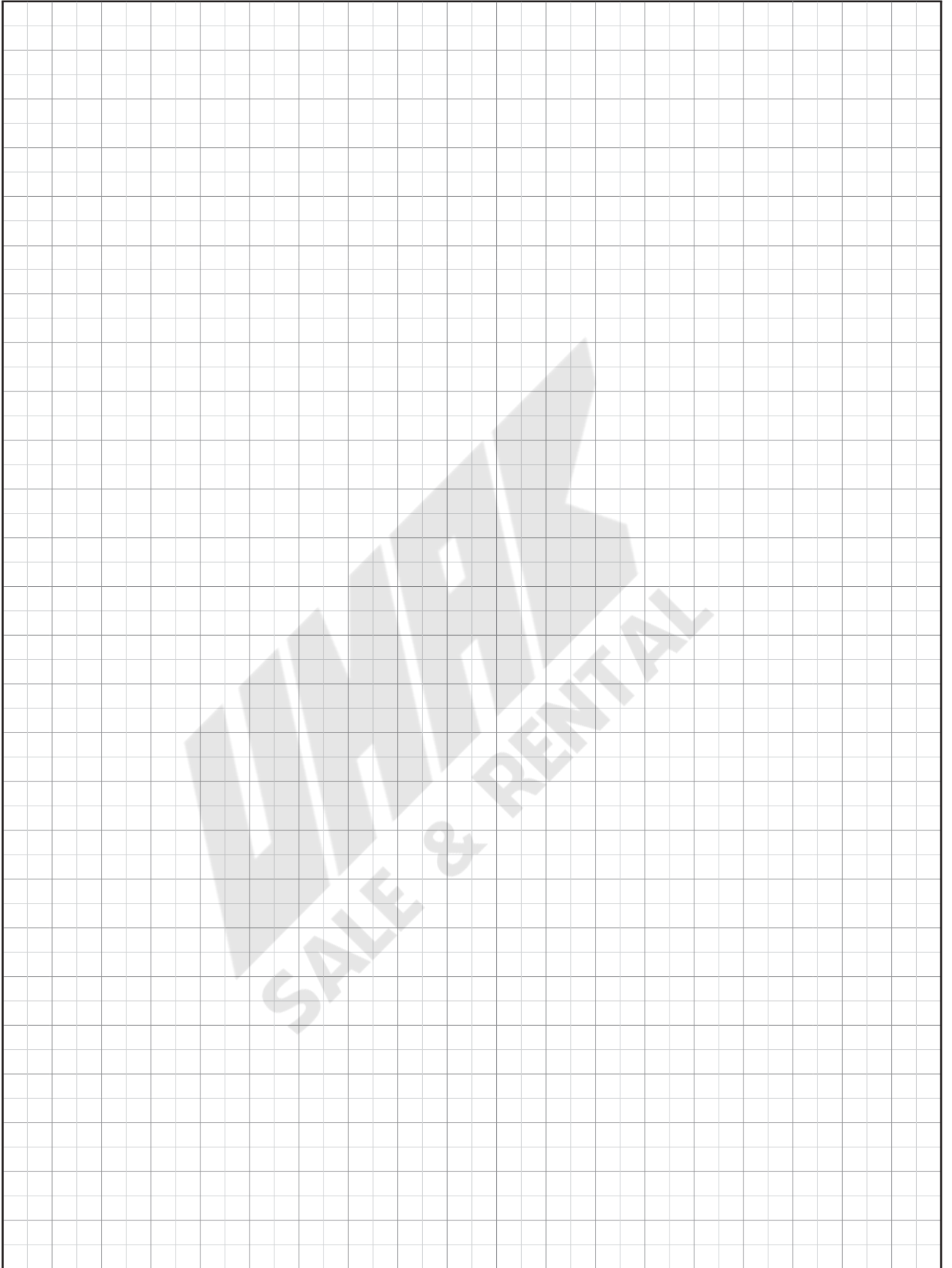

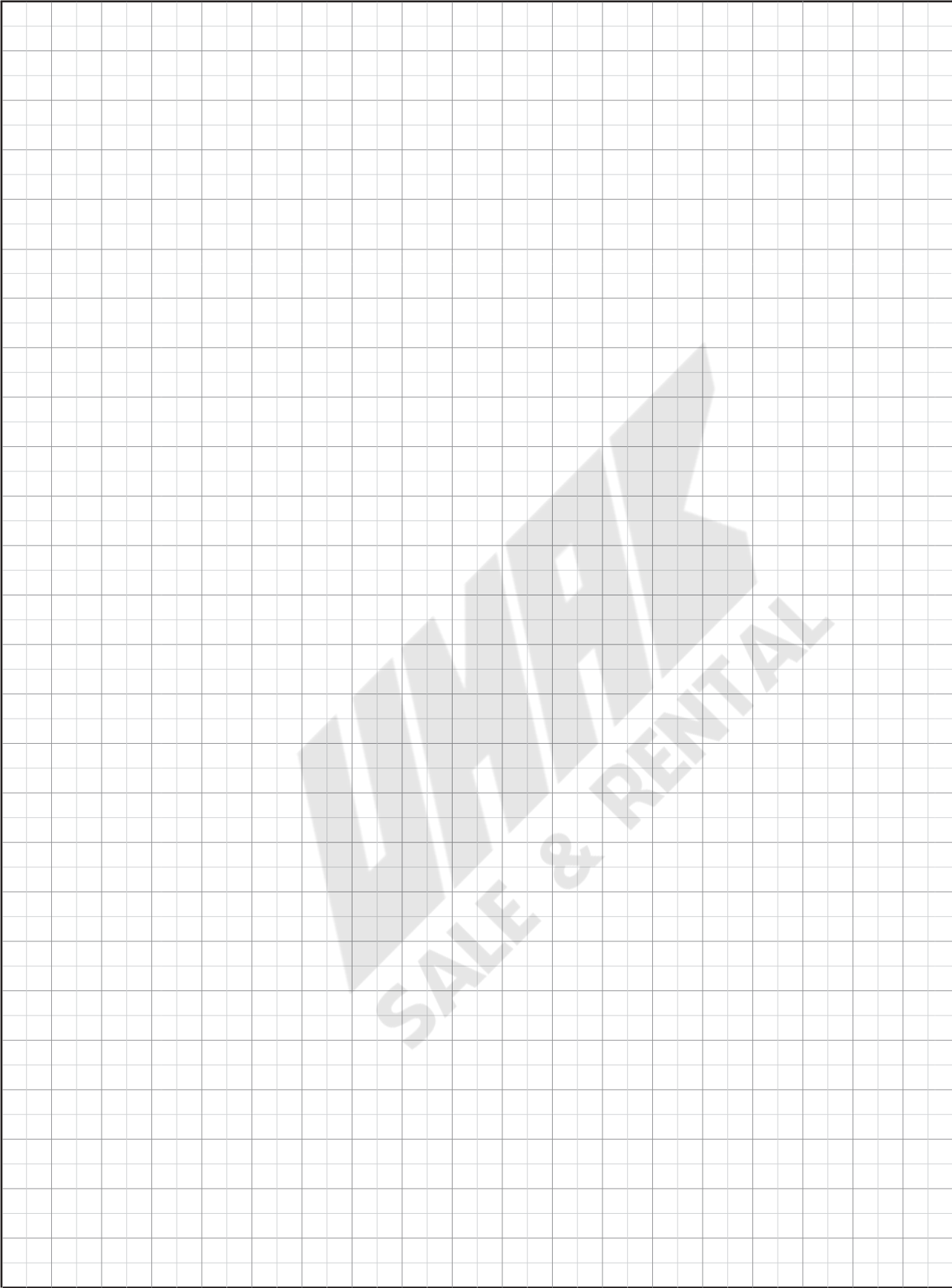



Backed by Manitowoc

CraneCARESM

CraneCARE is Manitowoc's comprehensive service and support program. It includes classroom and on-site training, prompt parts availability, expert field service, technical support and documentation — for every one of the more than 7,000 Manitowoc cranes currently in use throughout the world. That's commitment you won't find anywhere else. That's CraneCARE.



Manitowoc Cranes, Inc.
P.O. Box 70
Manitowoc, WI, USA 54221-0070
Telephone 920-684-6621
Facsimile 920-683-6277
www.manitowoccrane.com