



WMA
SALE & RENTAL

MANITOWOC 7000

HIGH CAPACITY, LONG REACH PICK & TRAVEL CAPABILITY

OUTLINE DIMENSIONS

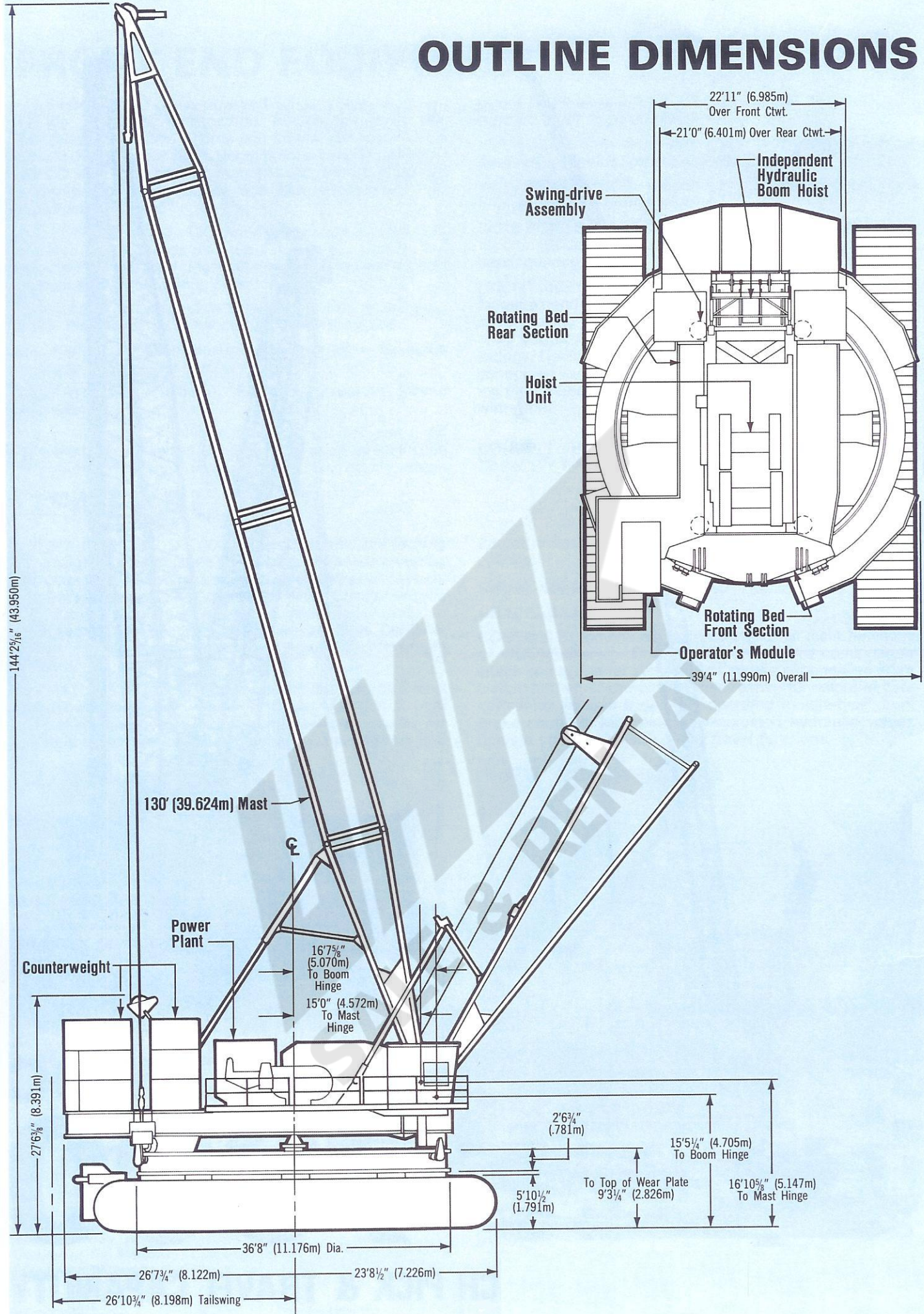

COVER ILLUSTRATIONS

Left: A Manitowoc Model 7000, equipped with a 400' boom and 100' jib, undergoes pre-delivery testing. Lifting a 30-ton test load at a 130' radius with its jib offset 20 degrees, the Model 7000 demonstrates its exceptional reach and heavy lift capabilities for long boom applications.

Right: During another pre-delivery test, this Model 7000 was equipped with a 150' boom to pick and walk with a 350-ton test load.

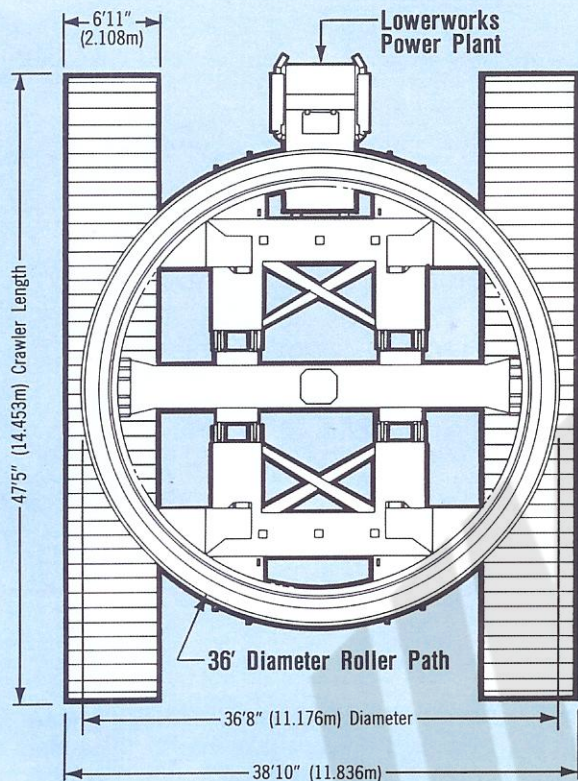

WEIGHTS

Pounds*

LIFTCRANE (complete): lowerworks, upperworks, and 150' basic boom 1,739,545

LOWERWORKS:

Front Carbody Beam 92,200
 Center Carbody Beam 86,600
 Rear Carbody Beam 92,200
 End Support Beam (4, each 8,590) 34,360
 King Pin 1,090
 Power Plant 12,300
 Crawler Assemblies (2) with 83" wide treads and hydraulic motors (each assembly 191,480) 382,960
 36' Diameter Roller Path, 4 segments with wear plates 136,150
 Ring Gear, 10 segments 6,410

UPPERWORKS:

Rotating Bed Assembly:
 Rear Section with Model 560 Hoist (2 drums on a single shaft), power plant, hydraulic boom hoist, 2 rear house and hook roller assemblies, 2 Swing-drive assemblies, boom hoist guide sheave assembly, links for backhitch attachment, mast stop support, and catwalks.
 Front Section with 4 house rollers, 2 hook roller assemblies, mast support, 2 Swing-drive assemblies, and operator's module complete with all operating controls and mounting bracket. 230,000
Removable Counterweight (13-piece):
 Rear Left and Right (4 boxes, each 46,500) 186,000
 Rear Center (3 boxes, each 46,000) 138,000
 Front Left and Right (6 boxes, each 38,000) 228,000
 Mast and Backhitch, 130' mast with ladder, mast stop, and pendant backhitch 48,500

BOOM NO. 64:

Butt (less wire rope and pendants) 14,300
 Top (equipped with 8-sheave lower boom point) 15,300
Inserts:
 25' (with pendants and wire rope guide) 6,500
 50' (with pendants and wire rope guide) 11,900

*Weights are approximate and may vary between machines as a result of design changes and component variations.

POWER PLANTS

| UPPERWORKS & LOWERWORKS: | Cylinder | Bore | Stroke | Cubic Inch Displacement | Net HP @ RPM (at flywheel) |
|---|----------|-------|---|-------------------------|----------------------------|
| Caterpillar 3412 DIT Dual Turbo | 12 | 5.40" | 6.00" | 1,649 | 590 @ 2,000 |
| Lowerworks Fuel Tank Capacity: 125 Gallons. | | | Upperworks Fuel Tank Capacity: 200 Gallons. | | |

For other power plant options, consult factory.

DRUMS AND LAGGINGS

| 560 HOIST 2-Drum | Application | Drum | Diameter | Drum Width | Wire Rope Size | Spooling Capacity | | |
|----------------------------|-------------|-------|----------|------------|----------------|-------------------|--------|---------|
| | | | | | | First Layer | Layers | Maximum |
| LIFTCRANE Hoist Whip | Right | Right | 28.00" | 31.797" | 1 3/8" | 107' | 13 | 3,311' |
| | Left | Left | 28.00" | 14.609" | 1 3/8" | 49' | 13 | 1,521' |

For other drum and lagging options, consult factory.

LOWERWORKS

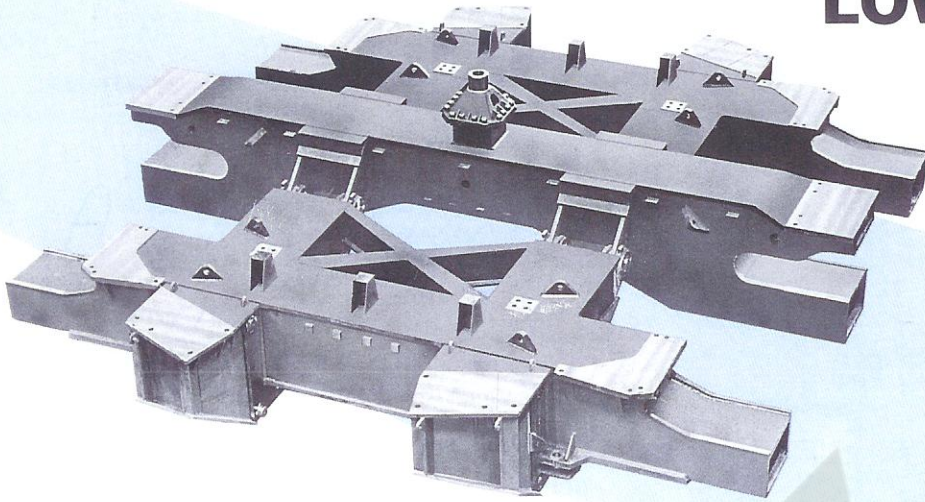

CARBODY: Three heavy-duty fabricated steel, deep-section beams pin-connect together and form the carbody. Beam ends are machined and mate with integral pockets in crawler side frames. Supports for 36' diameter roller path mount to front and rear beams with bolts and wedge locks. Center beam has mount for king pin.

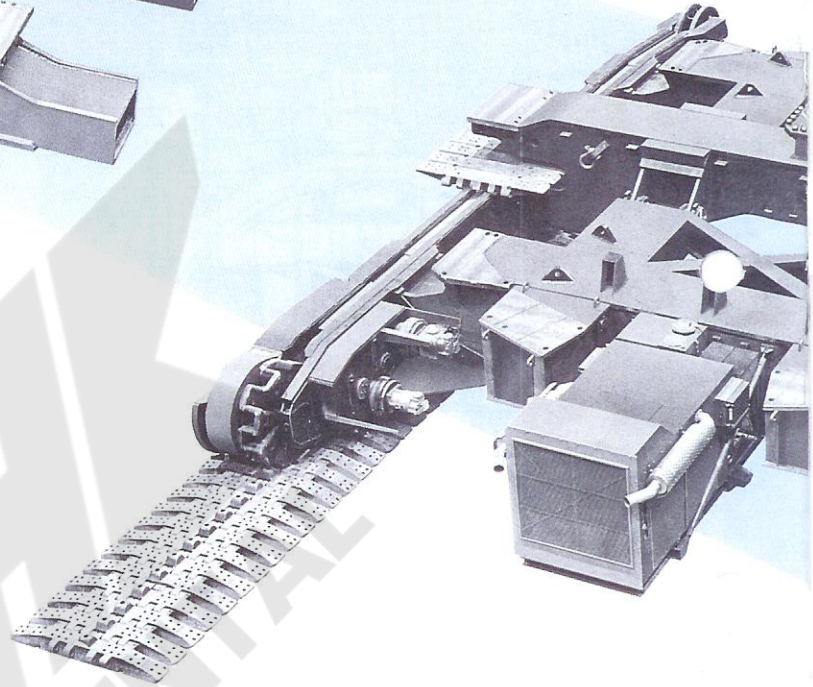

LOWERWORKS POWER TRAIN

TRAVEL DRIVE: Provided by independent hydraulic drive on each crawler. Power is transmitted from the hydraulic motors (one variable and one fixed displacement motor per crawler) to the crawlers via a planetary gear arrangement and a reduction gear train to the drive tumbler. This eliminates the need for conventional drive chains. Two variable displacement reversible pumps run the hydraulic motors, allowing the motors to change crawler rotation and provide travel in both directions. Crawlers can also be counter-rotated for maximum maneuverability.

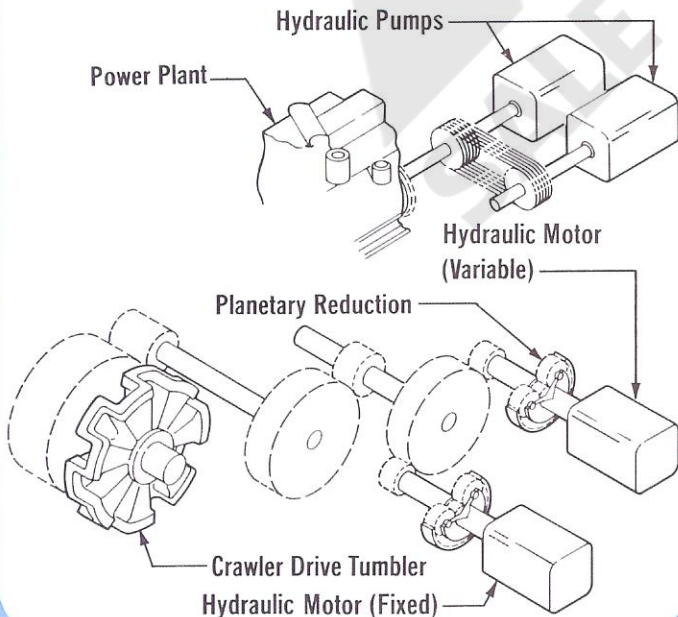

CRAWLER SIDE FRAMES: Two deep, reinforced, fabricated steel frames with integral pockets for mounting crawler frames on carbody beam ends. Each crawler frame fully encloses travel gears and provides mounting for hydraulic travel motors, crawler gear and tumbler, front idler roller, and 20 intermediate rollers. Intermediate rollers are mounted in pockets along underside of crawler frame. Slide rails of abrasion-resistant steel along crawler frame top provide smooth, continuous support for crawler tread and eliminate need for upper idler rollers.

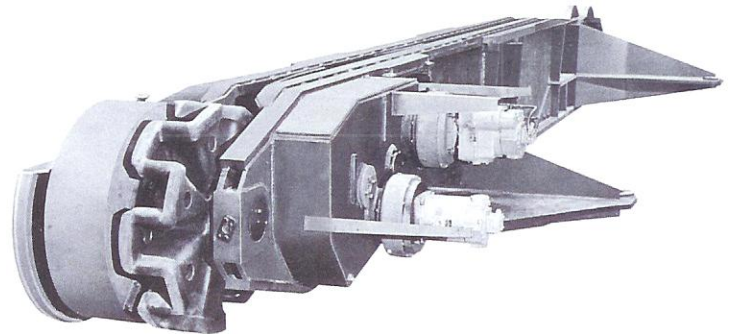

CRAWLER GEAR AND TUMBLER: Transmit drive torque. Constructed of cast steel. Mounted on stationary shaft with large bushing at each end and grease pocket in center. Shaft ends supported in crawler frame. Self-cleaning tumbler has alternate sides open.

INDEPENDENT TRAVEL POWER: Provided by an independent lowerworks diesel power plant mounted on a frame pinned to rear carbody beam. Diesel engine powers two variable-displacement hydraulic pumps, each driving one crawler frame's travel machinery. System enables each crawler to be rotated independently in either direction at variable speed. Travel controls located in operator's module and at engine.

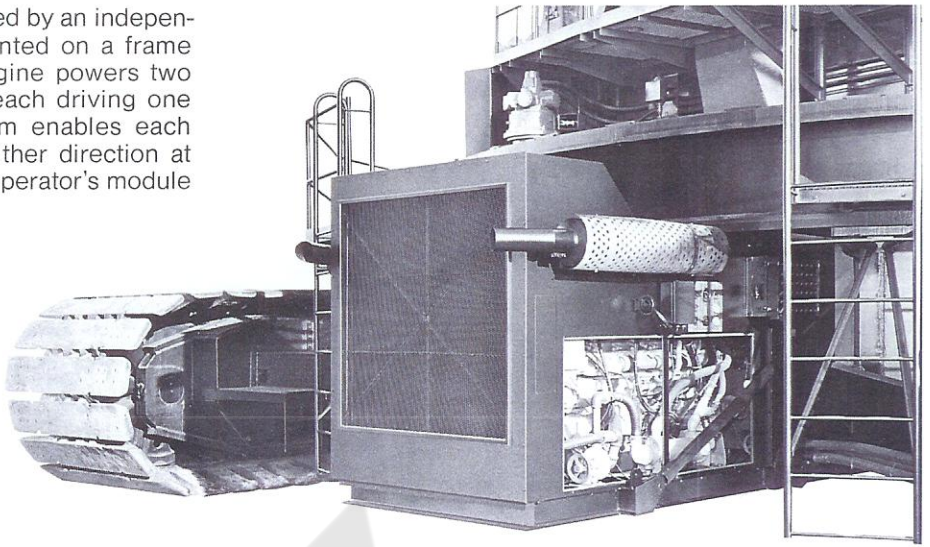

KING PIN: Cast steel. Bolted to center carbody beam with high-strength bolts. Provides pivot for rotating bed. Takes horizontal reactions only, no uplift.

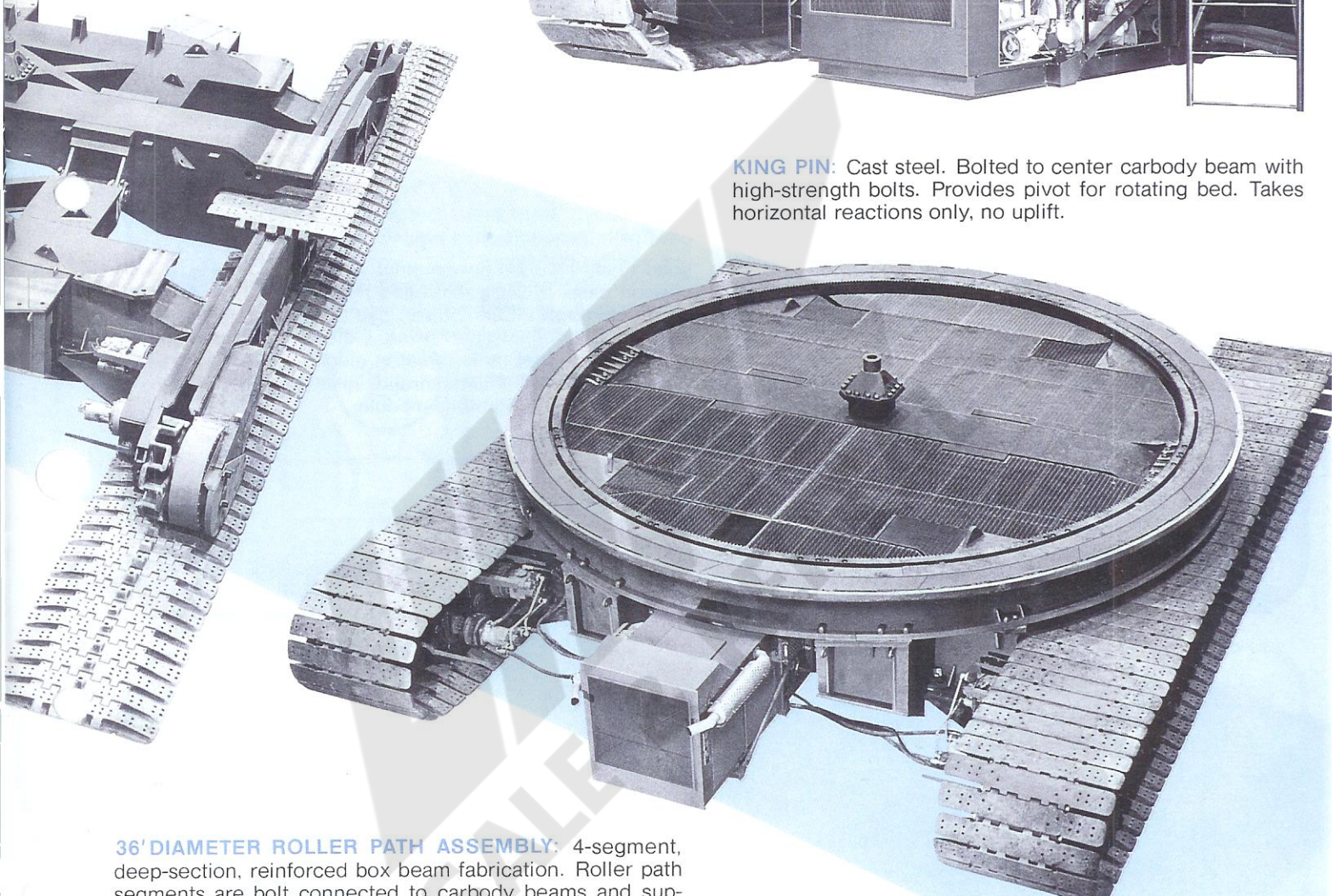

36' DIAMETER ROLLER PATH ASSEMBLY: 4-segment, deep-section, reinforced box beam fabrication. Roller path segments are bolt connected to carbody beams and supports. Path has 30" depth, 26" wide face, and 3/4" thick flange. Roller path top has 14 alloy steel wear plates, and underside of hook roller flange 16 wear plates. Assembly also includes 10-segment internal ring gear bolted to roller path, internal service platform, external catwalks, and king pin.

CRAWLER TREADS: 83" wide, with 91 pads per crawler frame. Pads constructed of cast alloy steel in a closed box-section design with large center driving lug. Adjacent pads connected by two high-carbon steel pins.

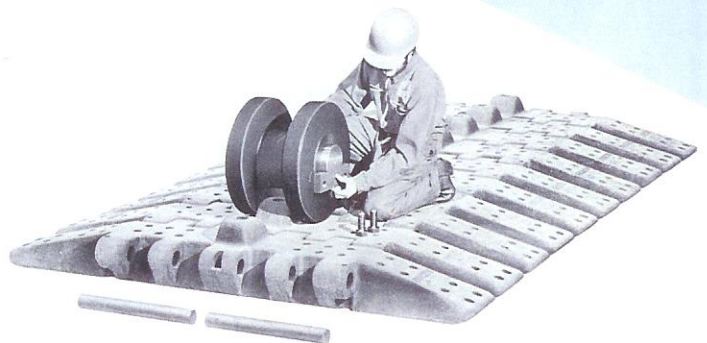

UPPERWORKS

SECTIONAL ROTATING BED: Rear section constructed of fabricated deep girder side beams with lattice-type internal framing. Provides support for load hoist, independent boom hoist, mast stop, and counterweight. Rear bed section includes catwalks and railings, two pair of equalized antifriction bearing mounted rear house rollers, and two pair of antifriction bearing mounted rear hook rollers.

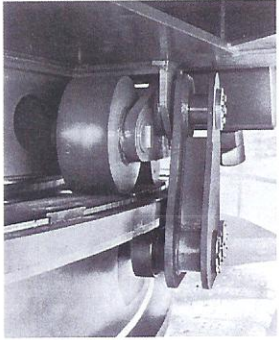

**REAR HOUSE
AND HOOK ROLLERS**

Front section, shown to right of operator's module in main illustration below, is a fabricated box-section construction pin connected to rear section. Provides lugs for boom and mast hinge pins. Rolls on four large antifriction bearing mounted house rollers. Assembly also includes two pair of antifriction bearing mounted hook rollers.

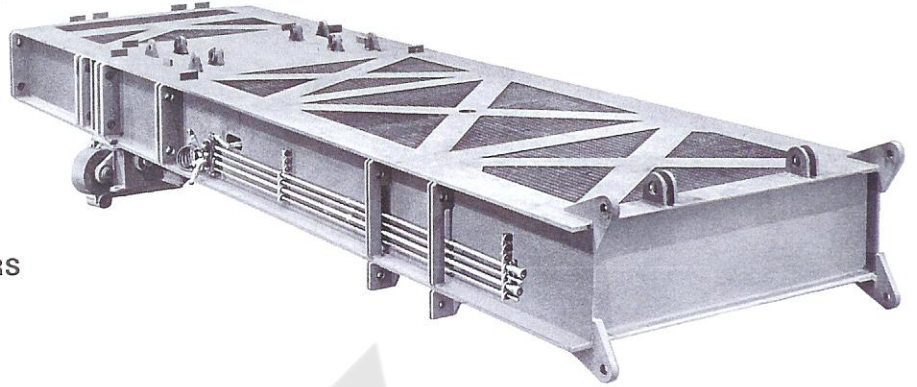

LOAD HOIST: VICON® (Variable Independent CONTROL) equipped Model 560 Hoist with power plant and drum options to provide versatility in meeting specific application requirements. Shown is a two-drum arrangement with wide and narrow drums antifriction bearing mounted on a single shaft. Each drum is equipped with an air-applied clutch, an

air-released, air-applied, spring-set brake, and a ratchet and pawl. All gears and drive chains are fully enclosed.

Load hoist includes power plant with diesel engine, transmission case, VICON controlled torque converter for load hoist, full-range VICON power load lowering, and hydraulic pumps for boom hoist and swing. Other power plant components include fuel tank, radiator, electric starting, air compressor, and engine shroud. Instrument panel and air controls in operator's module.

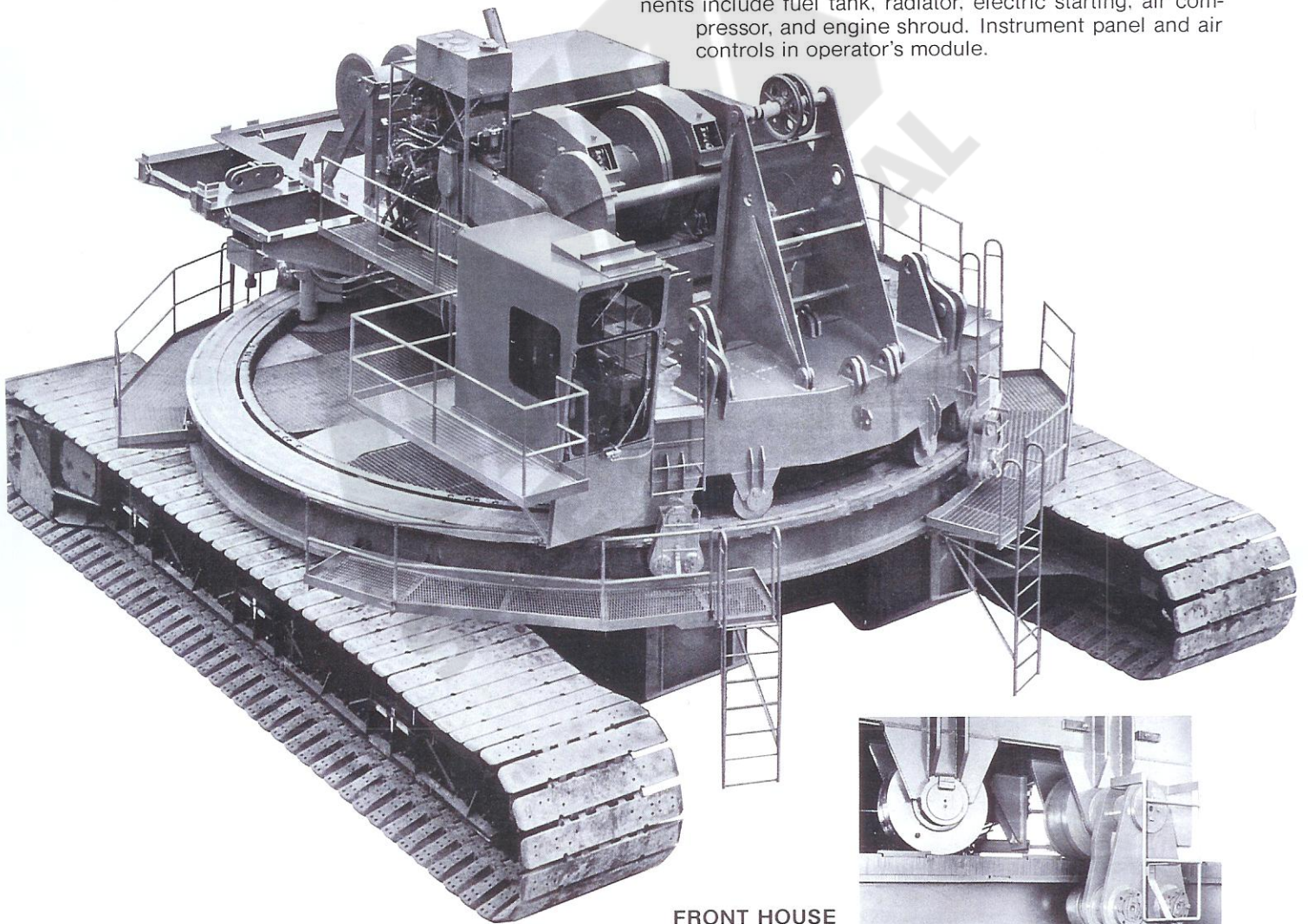

**FRONT HOUSE
AND HOOK ROLLERS**

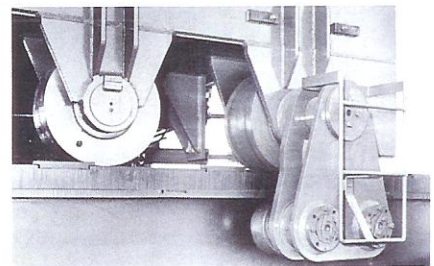

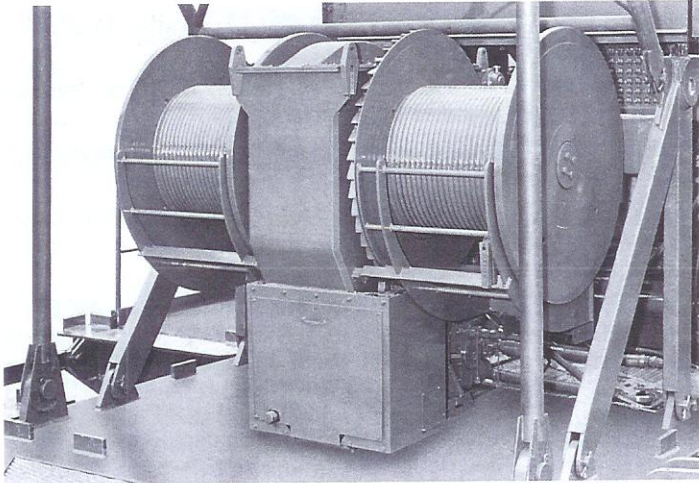

INDEPENDENT BOOM HOIST: Grooved dual drums on alloy steel shaft. Driven through gear and pinion reduction by alloy steel worm shaft and bronze worm wheel. All rotating shafts are antifriction bearing mounted; all gears are fully enclosed and run in oil. Boom hoist powered by variable-displacement hydraulic motor, providing full-range speed control. Boom hoist main brake external-contracting band-type, air-released, air-applied, and spring-set. Auxiliary brake external-contracting band-type, air-applied and air-operated from operator's module. Ratchet on boom hoist drum flange, with pawl mounted on gear housing. Boom hoist pinned to rotating bed.

UPPERWORKS POWER TRAIN

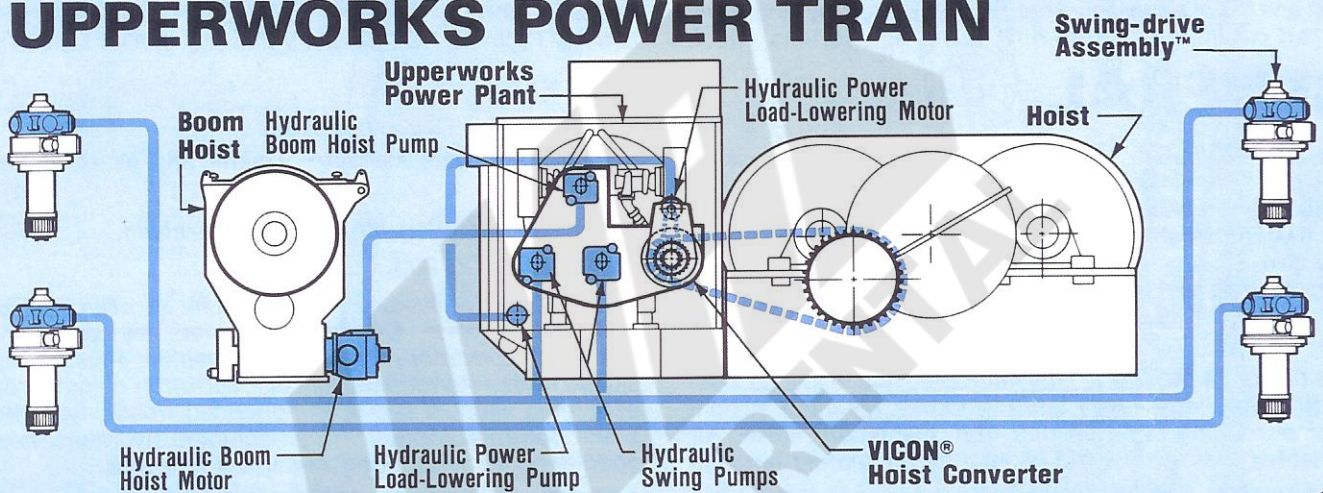

SWING-DRIVE ASSEMBLY™

The Model 7000's swing function is performed by Manitowoc's exclusive, patented, Swing-drive system. This hydraulically-powered system provides swing acceleration or deceleration in either direction. Operation is controlled by a single lever, and free swing exists when lever is in neutral position. Control lever also applies swing service brakes, one located on each Swing-drive unit. System uses as many Swing-drive units as required to meet specific applications. In each unit, a hydraulic motor powers a direct drive pinion held in constant mesh with the ring gear by hydraulic and spring positioners. A drive pinion flange and gear segment skirt maintain pitch control between pinion and ring gear.

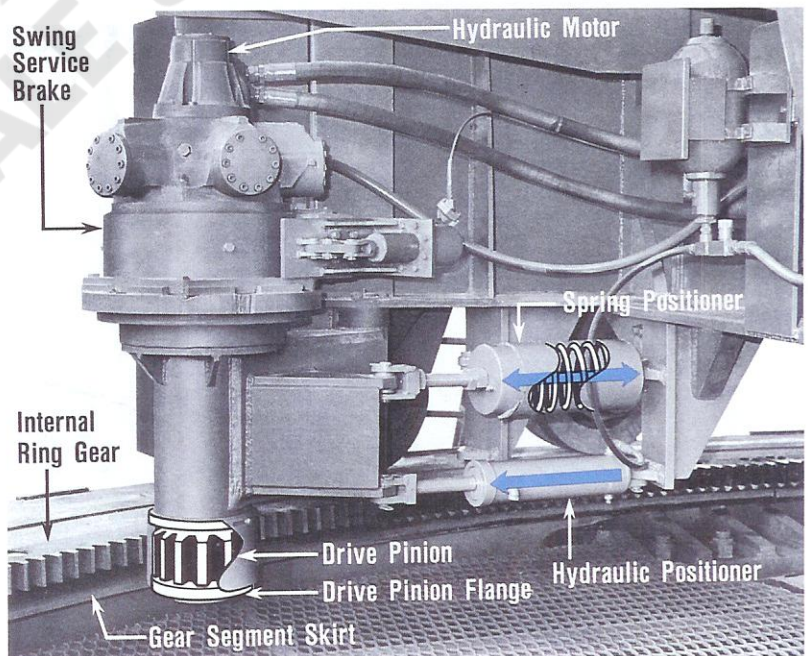

FRONT END EQUIPMENT

NO. 64 BOOM: 50' heavy-duty butt, 25' and 50' inserts, and 50' top. All-welded construction. Rectangular boom with fabricated box-section chords and tubular lacings. Chords are 100,000 PSI yield steel. Boom point equipped with eight 32" OD antifriction bearing mounted sheaves for maximum sixteen-part 1 $\frac{3}{8}$ " diameter wire rope. Basic boom length 150'; maximum length 400'.

NO. 27 FIXED MAST: 130' rectangular section mast with inverted angle chords and tubular lacings. Chords are 100,000 PSI yield steel. Mast pin-connected to mast support on front section of rotating bed.

TELESCOPIC BOOM STOPS: Air-cushioned telescoping tubes. Pin-connected to boom butt and rotating bed.

MAST STOP: Two-piece box-section construction. Supports mast when boom hoist lines are slack.

BACKHITCH PENDANTS: Four 2 $\frac{1}{4}$ " structural strand pendants.

BOOM RIGGING: Twelve-part line reeved between fixed mast and boom equalizer. Controls boom angle by single line reeved continuously from dual boom hoist drums, which

power boom up and down. Two pair of 1 $\frac{3}{8}$ " pendants connect equalizer to boom point.

EQUALIZER: Fabricated steel frame supporting six vertical sheaves, all antifriction bearing mounted.

WIRE ROPE GUIDE: Mounted on top side of boom. Two fleeting sheaves bronze bearing mounted.

WIRE ROPE ROLLER GUIDE: Mounted on top side of boom inserts. Roller is induction hardened tubing, antifriction bearing mounted.

NO. 127 JIB: Optional. 80-ton maximum capacity. 40' basic length extendible to 60', 80', or 100' with 20' and 40' inserts and matching pendants. Jib offset angle adjustable to 3, 10, or 20 degrees. All-welded construction. Tubular chords and lacings. Rectangular box section 55" wide x 45" deep at pin-connected joints. Jib point has two 32" OD antifriction bearing mounted sheaves for maximum four-part 1 $\frac{3}{8}$ " diameter wire rope.

CONSULT JIB LIFTING CAPACITY CHARTS FOR SPECIFIC CAPACITY WHEN USED ON VARIOUS BOOM LENGTHS.

GENERAL

COUNTERWEIGHT: 552,000 pounds. Optional interlocking filled steel boxes. Complete set consists of 4 boxes weighing 46,500 pounds each, 3 boxes weighing 46,000 pounds each, and 6 boxes weighing 38,000 pounds each. Counterweights may also be supplied at job site in most readily-available form, such as cast concrete, steel plate, or billets. Certification of weights is recommended to assure counterweight accuracy.

OPERATOR'S MODULE: Fully enclosed and insulated steel module with large safety glass windows. Mounted at right front of rotating bed. Isolated from machinery noise. Air signal horn, air windshield wipers, air circulating fan, and

24-volt dome light standard. Heater and air conditioner optional.

SWING SPEED: Variable, 2.5 RPM maximum.

GRADEABILITY: 20%.

CONTROLS: Modulating air controls for all main functions of VICON[®] system. Drum control levers are combination clutch and converter control: first movement engages drum clutch; further movement increases converter output torque, permitting variable speed. Air-operated treadle-type drum brake controls. Modulating air-actuated hydraulic valves operate boom hoist, swing, and travel functions.

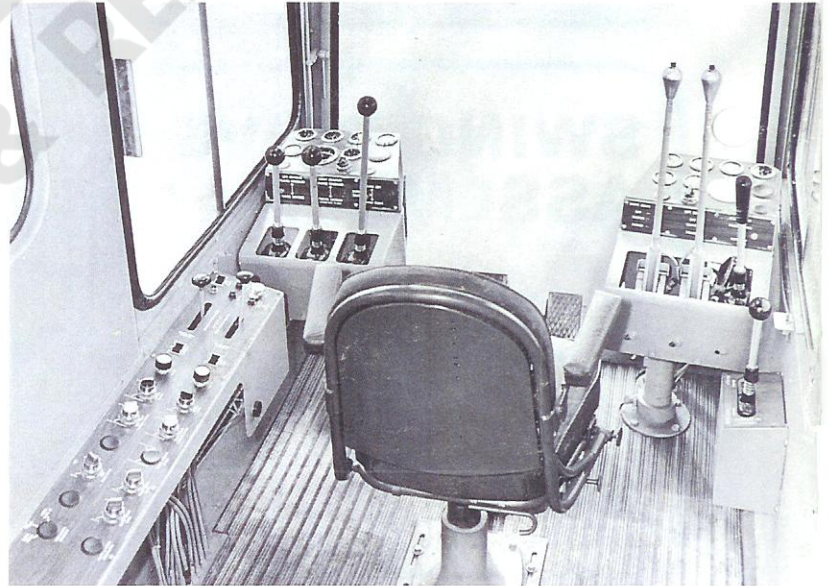
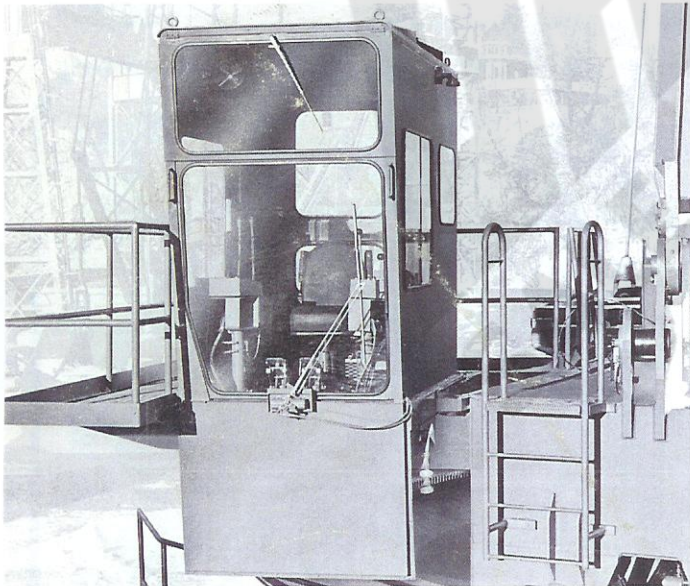

Because of a program of continuing improvements, Manitowoc Engineering Co. reserves the right to change specifications at any time, without notice.

MANITOWOC ENGINEERING CO.
Division of The Manitowoc Company, Inc.
Manitowoc, Wisconsin 54220

The Manitowoc logo, featuring the word "Manitowoc" in a stylized, bold, sans-serif font. The letters are white with a blue outline, set against a blue circular background.

Litho in U.S.A.