



model 5000

product guide

- 50 ton Lift Capacity
- 1,200 ft-kips Maximum Load Moment
- 160' Heavy-Duty Boom
- 190' Fixed Jib on Heavy-Duty Boom
- 213 HP engine
- 338 fpm line speed
- 35,000 lb Maximum Line Pull
- 16,800 lb Rated Line Pull
- 15,500 lb Material Rehandling Clamshell capacity
- Fast, efficient self-assembly and disassembly
- Manitowoc Crane CARE comprehensive support



contents

Specifications	3
Outline Dimensions	6
Winch Performance Data	10
Boom Combinations	11
Load Chart Notes	12
Heavy-lift Boom Range / Load Charts	13
Fixed Jib Range / Load Charts	15
Clamshell	18
Dragline	19



 **model 5000**

UMAX
SALE & RENTAL

specifications

Upperworks



Engine

Mitsubishi 6D16-TLA2B, 6 cylinder, water-cooled diesel, direct fuel injection with turbocharger, 159 kW (213 HP) @ 2000 high-idle RPM. Maximum torque 593 lb·ft (804 N·m) net at 1,600 rpm (SAE J 1349).

One diesel fuel tank, 74 gallons (280 liters).

Two 12 volt 120 AH capacity, 24 volt system and 80 amp alternator.

All wiring harnesses and connectors are numbered for easier servicing. Machine is equipped with individual fused branch circuits.



Controls

Full-flow hydraulic control system for constant variable pressure to front and rear drums, boom hoist brakes and clutches. Controls respond instantly to the touch, delivering smooth function operation.

Relief valve pressures:

Load hoist, boom hoist and propel system 4,120 psi (290 kg/cm²)
Swing system 3,200 psi (225 kg/cm²)
Control system 1,490 psi (105 kg/cm²)



Hydraulic System

All three variable displacement piston-type pumps are driven by a heavy-duty pump drive. One of these pumps is used in the right propel circuit and hook hoist circuit, and can accommodate an optional third circuit. Another is used in the left propel circuit, boom hoist circuit and hook hoist circuit. The third variable displacement pump is used in the swing circuit. In addition, two gear pumps are used in the control system and auxiliary equipment.

Maximum pressure rating 4,125 psi (28,4 MPa)

Load hoist, boom hoist and propel ... 2 Piston pumps
Swing 1 Piston pump
Control system and auxiliary 2 Gear pumps

Reservoir capacity: 66 US gallon (250 liter).

Cooling: Oil-to-air heat exchanger (plate-fin type).

Filtration: Full-flow and bypass type with replaceable paper element.



Drums

Front and rear drums for load hoist powered by hydraulic variable displacement piston-type motors, driven through planetary reducers. Powered hoisting/lowering and free-fall operation is standard. Drum turn indicators for front and rear drums are also standard.

Clutch: internally expanding band clutch.

Brake: externally contracting spring set, hydraulically released, band type brake operated through a counterbalance valve. An external ratchet is fitted for locking the drum.

Drums: front and rear 16.5" (419 mm) P.C.D. X 16.9" (427 mm) wide, grooved for 3/4" (20 mm) wire rope.

Wire rope capacity:

Front drum 558' (170 m) working length
Rear drum 426' (130 m) working length
Storage length (each drum) 919' (280 m)

Line speed: Single line on the first drum layer

Hoisting 230 ft/min (70 m/min)

Lowering 230 ft/min (70 m/min)

Line speed based on single line on the first drum layer.

Standard third drum: Third drum is powered by hydraulic variable displacement piston-type motor, driven through a planetary reducer. Powered hoisting/lowering and free-fall operation is standard. Drum turn indicator is also standard.

Clutch: internally expanding band clutch.

Brake: externally contracting spring set, hydraulically released, band type brake operated through a counterbalance valve. An external ratchet is fitted for locking the drum.

Drum: third drum 11.6" (294 mm) P.C.D. X 14.9" (378 mm), grooved for 9/16" (14,5 mm) wire rope.

Line speed: Single line on the first drum layer

Hoisting 197 ft/min (60 m/min)

Lowering 197 ft/min (60 m/min)

Line speed based on single line on the first drum layer.

Wire rope capacity:

Third drum 787' (240 m) working length
Storage length (each drum) 787' (240 m)

3

specifications



Swing System

4

Swing unit: Powered by a hydraulic piston-type motor driving spur gears through planetary reducers, the swing system provides 360° rotation.

Swing brake: A spring-set, hydraulically released multiple-disc brake is internally fitted in swing motor.

Swing lock: 2 Position lock for transportation.

Rotating bed turntable: Single-row ball bearing with an integral internally cut swing gear.

Swing speed 3.5 rpm



Boom Hoist

Single drum powered by a hydraulic variable displacement piston motor through a planetary reducer. Grooved drum including 407' (124 m) of 9/16" (14,5 mm) diameter wire rope reeved with 12 parts of lline. Boom hoist speed: 223 ft/min (68 m/min) hoisting/lowering.

Brake: A spring-set, hydraulically released multiple-disc brake is internally fitted in the boom hoist motor and operated through a counter-balance valve. An external ratchet is fitted for locking the drum.



Gantry

This high folding type gantry is fitted with a sheave frame for boom hoist reeving. It provides full up, full down positions.



Counterweight

QTY.	ITEM	UNIT WEIGHT		TOTAL WEIGHT	
		kg	lb	kg	lb
1	Counterweight A	5 000	11,023	5 000	11,023
1	Counterweight B	5 000	11,023	5 000	11,023
1	Counterweight C	5 400	11,905	5 400	11,905
Counterweight TOTAL		15 400	33,951		



Operator's Cab

Totally enclosed, full vision cab fitted with tinted safety glass. A fully adjustable, highbacked seat with arm rests permits operators to set their ideal working position. Side mounted console for auxiliary controls and instruments. An air conditioner, a signal horn, cigarette lighter, windshield wiper and inspection lamp socket are standard features.

Controls

In front of operator are the foot pedals for front, rear and third drum brakes and foot throttle pedal. At operator's right side are the travel (propel) control levers and the function lock lever. To the operator's right front are the boom hoist control lever, front and rear winch control levers and the free-fall select switches for the front and rear winches and drum turn indicators (front/rear drum). To the operators left front are the swing control lever and third drum control lever To the operator's left are the crawler extend/retract lever and the positive swing lock. The left-hand console contains switches for the anti-two-block/boom overhoist. Directly in front of the console are the drum pawl lock for boom, front, rear and third drum and the engine ignition key. The swing brake and signal horn are mounted on the swing control lever.

Gauges

Fuel gauge, engine water temperature gauge, hour meter and tachometer are located on the monitor display.

Warning display

All potential warnings, including battery charge, engine oil pressure, air cleaner, engine oil filter, control main pressure, and hydraulic oil temperature will appear on the monitor display when a fault occurs.

Safety devices

Function lock lever, anti-two-block, boom over hoist limit switch, boom angle indicator, signal horn, boom hoist drum lock, front and rear drum lock, swing lock, swing alarm (buzzer and lamps), boom backstops, safety latch on hook blocks, and load moment indicator.

Lowerworks



Carbody

The durable carbody features steel welded construction with axles.



Crawlers

Crawler assemblies can be hydraulically extended for wide-track operation or retracted for transportation. Crawler belt tension adjusted with hydraulic jack and maintained by shims between idler block and frame.

Crawler drive

The independent hydraulic propel drive is built into each crawler side frame. Each drive consists of a hydraulic motor driving a propel sprocket through a

specifications

planetary gearbox. The hydraulic motor and gearbox are built into the crawler side frame within the shoe width. The track rollers are sealed for maintenance-free operation.

Crawler brakes

Spring set, hydraulically released, multiple disc-type parking brakes are built into each propel drive.

Steering mechanism

The hydraulic propel system provides both skid steering (driving one track only) and counter-rotating steering (driving each track in opposite direction), as well as, differential track speed.

Crawler shoes

59 shoes, 36" (914 mm) wide, each crawler.

Travel speed

0.87 mph (1,4 km/h)

Attachments



Boom

Welded lattice construction using tubular, high-tensile steel chords with pin connections between sections. Boom tip is open throat construction. Three idler sheaves and four point sheaves are standard.

Basic boom length 30' (9,14 m) consists of the boom butt section 15' (4,57 m) and boom top section 15' (4,57 m).

Optional boom inserts are available to provide extension capabilities. They also have welded lattice construction with tubular, high-tension steel chords and pin connections on each one of 10' (3,0 m), 20' (6,1 m), 30' (9,14 m) inserts.

Maximum total length of boom 160' (48,77 m).



Fixed Jib

The optional fixed jib employs welded lattice construction with tubular, high-tension steel chords with pin connections between sections.

Basic jib length 20' (6,10 m) consists of Jib butt section 10' (3,0 m) and Jib top section 10' (3,0 m).

Optional jib inserts of 10' (3,0 m), and 20' (6,1 m) are available for extension capabilities up to 60' (18,3 m).

Maximum total length 190' (57,9 m) consists of boom 130' (39,6 m) and jib 60' (18,3 m).

Tools and Accessories

A set of tools and accessories are furnished.

5

Optional Equipment

Optional: Blocks and Hooks

7 US ton ball hook, 202 lbs.

30 US ton hook block, 670 lbs, two 16" Nom. OD roller bearing sheaves grooved for 3/4" dia. wire rope, and roller bearing swivel with hook latch.

50 US ton hook block, 1,089 lbs, four 16" Nom. OD roller bearing sheaves grooved for 3/4" wire rope, roller bearing swivel with hook latch.

Detachable upper boom point
Custom color

outline dimensions

6

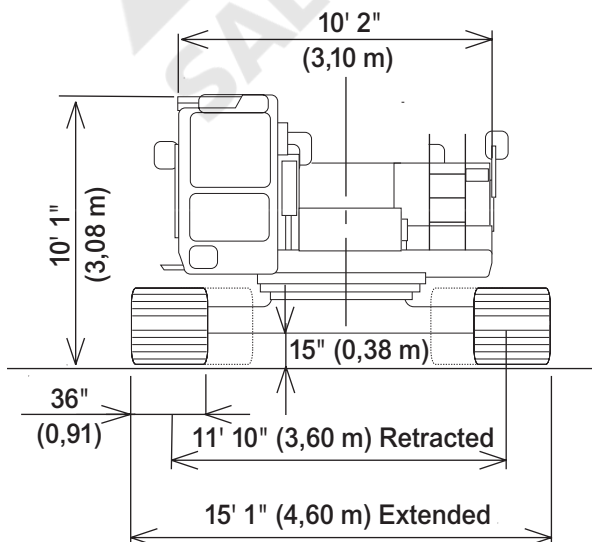
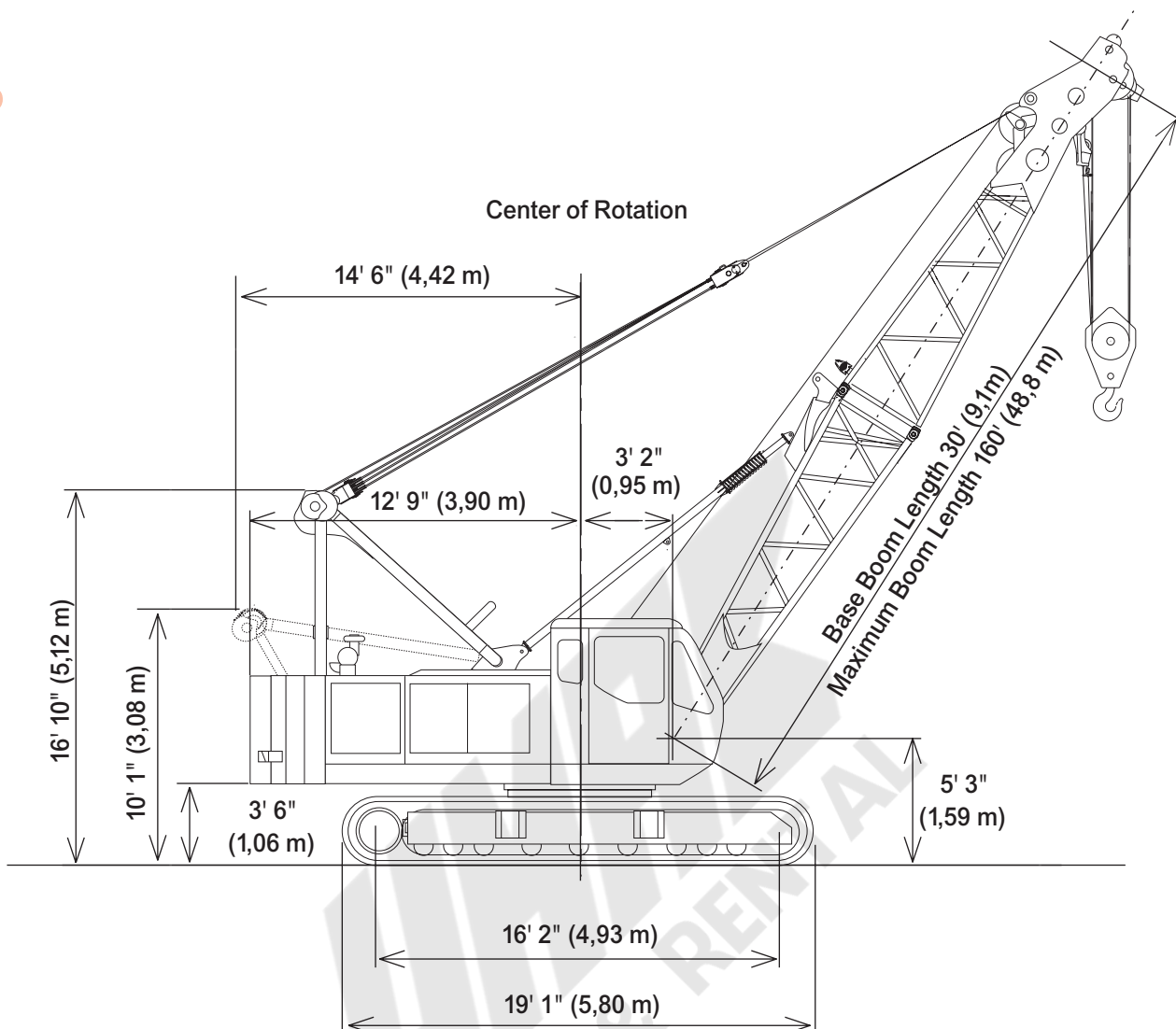

outline dimensions

7

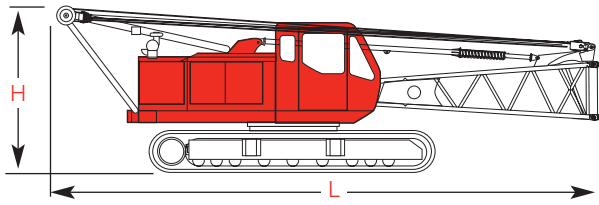

Upperworks x 1

Length	12,05 m	39' 6"
Width	3,69 m	11' 10"
Height	3,08 m	10' 1"
Weight	30 530 kg	67,320 lb

Note: Weight includes base machine, crawler, gantry, maximum hoist and whip lines on drums, third drum, boom butt, full hydraulic fluid reservoir, and half tank of fuel.

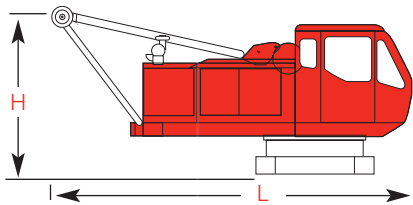

Upperworks x 1

Length	5,97 m	19' 7"
Width	3,45 m	11' 3"
Height	2,70 m	9' 9"
Weight	16 900 kg	37,265 lb

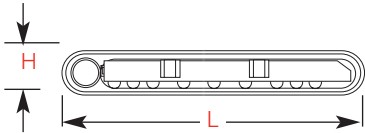

Crawlers x 2

Length	5,81 m	19' 0"
Width	0,91 m	3' 0"
Height	0,90 m	2' 11"
Weight	6 300 kg	13,890 lb

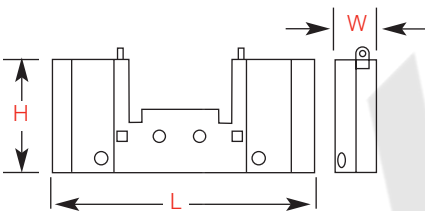

Upper Counterweight A x 1

Length	2,95 m	9' 8"
Width	0,47 m	1' 6"
Height	1,25 m	4' 8"
Weight	5 000 kg	11,023 lb

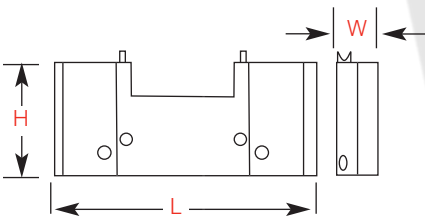

Upper Counterweight B x 1

Length	2,95 m	9' 8"
Width	0,47 m	1' 6"
Height	1,25 m	4' 8"
Weight	5 000 kg	11,023 lb

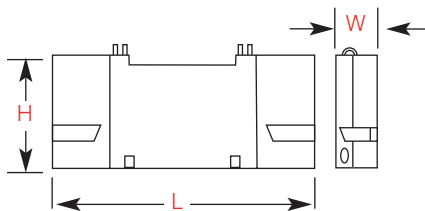

Upper Counterweight C x 1

Length	2,95 m	9' 8"
Width	0,49 m	1' 7"
Height	1,25 m	4' 8"
Weight	5 400 kg	11,905 lb

Option

outline dimensions

8

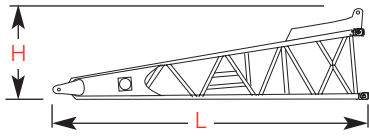

Boom Butt 15' x 1

Length	4,73 m	15' 6"
Width	1,37 m	4' 6"
Height	1,63 m	5' 4"
Weight	590 kg	1,300 lb

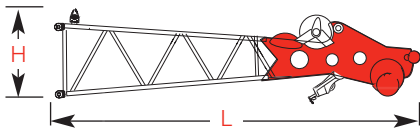

Boom Top 15' x 1

Length	5,10 m	16' 9"
Width	1,37 m	4' 6"
Height	1,37 m	4' 6"
Weight	930 kg	2,050 lb

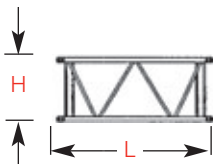

▶ Boom Insert 3,0 m (10') x 1, 2

Length	3,15 m	10' 4"
Width	1,37 m	4' 6"
Height	1,50 m	4' 11"
Weight	240 kg	530 lb

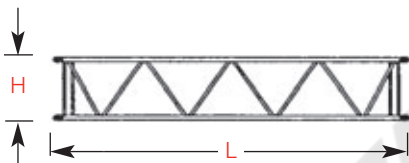

▶ Boom Insert 6,1 m (20') x 1, 2, 3

Length	6,20 m	20' 4"
Width	1,37 m	4' 6"
Height	1,50 m	4' 11"
Weight	430 kg	950 lb

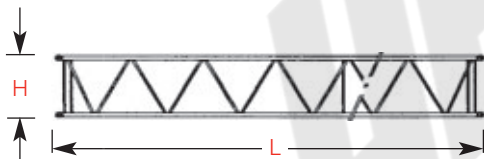

▶ Boom Insert 9,14 m (30') x 1, 2

Length	9,25 m	30' 4"
Width	1,37 m	4' 6"
Height	1,50 m	4' 11"
Weight	570 kg	1,260 lb

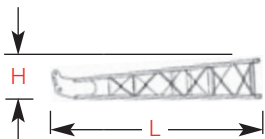

▶ Fixed Jib Butt x 1

Length	3,19 m	10' 6"
Width	0,57 m	1' 11"
Height	0,56 m	1' 10"
Weight	130 kg	290 lb

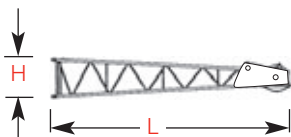

▶ Fixed Jib Top x 1

Length	3,38 m	11' 0"
Width	0,57 m	1' 11"
Height	0,47 m	1' 6"
Weight	170 kg	375 lb

▶ Option

outline dimensions

9

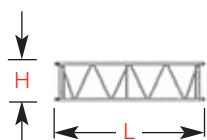

Fixed Jib Insert 3,0 m (10') x 1, 2		
Length	3,12 m	10' 3"
Width	0,57 m	1' 11"
Height	0,47 m	1' 6"
Weight	95 kg	210 lb

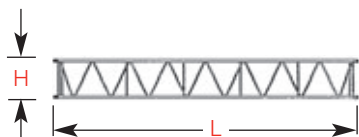

Fixed Jib Insert 6,1 m (20') x 1		
Length	6,16 m	20' 3"
Width	0,57 m	1' 11"
Height	0,47 m	1' 6"
Weight	165 kg	365 lb

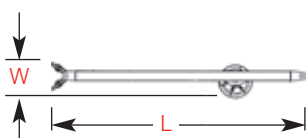

Fixed Jib Strut x 1		
Length	3,17 m	10' 5"
Width	0,62 m	2' 0"
Weight	200 kg	440 lb

WMA
SALE & RENTAL

Option

winch performance data

10

Line pull

	Rated line pull	*Maximum line pull
Front Drum	16,800 lbs (7 620 kg)	35,273 lbs (16 000 kg)
Rear Drum	16,800 lbs (7 620 kg)	35,273 lbs (16 000 kg)
Standard 3rd Drum	N/A (N/A)	11,000 lbs (4 990 kg)

* Maximum line pull is not based on wire rope strength.

Wire rope specifications

Use	Specs	Diameter inch (mm)	Working Length feet (m)	Breaking Strength lbs (kg)
Front Drum	IWRC 6 X Fi (25) C/O	3/4" (19,4)	558' (170)	58,900 (26 700)
Rear Drum	IWRC 6 X Fi (25) C/O	3/4" (19,4)	426' (130)	58,900 (26 700)
Boom Hoist Drum	IWRC 6 X WS (26) C/O	9/16" (14,5)	407' (124)	33,500 (15 200)
Third Drum	IWRC 6 X WS (26) C/O	9/16" (14,5)	787' (240)	33,500 (15 200)

Model 5000 Front & Rear Winch

Line speed (ft/min)								
Layer	1	2	3	4	5	6	7	
Line Pull (lbs)								
0	230	248	266	284	302	320	338	
5,000	229	246	264	282	299	317	334	
10,000	227	244	263	279	296	313	330	
Rated Line pull	16,800	201	201	198	193	185	182	180
	20,000	164	158	153	153	153	151	148
	25,000	123	121	119	115			
	30,000	97						

Line speed (m/min)								
Layer	1	2	3	4	5	6	7	
Line Pull (kgf)								
0	70	76	81	87	92	97	103	
2 268	70	75	80	86	91	96	102	
4 536	69	74	80	85	90	95	101	
Rated Line pull	7 620	61	61	60	59	56	55	55
	9 072	50	48	47	47	47	46	45
	11 340	37	37	36	35			
	13 608	30						

Note:

Line speeds and line pull based on single line.

Line pulls are not based on wire rope strength.

boom combinations

No. 5000 Heavy-Lift Boom Combinations

Boom Length m (ft)	Boom Inserts		
	3,1 m (10 ft)	6,1 m (20 ft)	9,14 m (30 ft)
9,14 (30)	-	-	-
12,2 (40)	1	-	-
15,2 (50)	-	1	-
18,3 (60)	1	1	-
21,3 (70)	1	-	1
24,4 (80)	1	2	-
27,4 (90)	1	1	1
30,5 (100)	-	2	1
33,5 (110)	1	2	1
36,6 (120)	-	3	1
39,6 (130)	1	3	1
42,7 (140)	1	2	2
45,7 (150)	-	3	2
48,8 (160)	1	3	2

No. 5000 Fixed Jib Combinations

Jib Length m (ft)	Fixed Jib Inserts	
	3,1m (10 ft)	6,1m (20 ft)
6,1 (20)	-	-
9,1 (30)	1	-
12,2 (40)	-	1
15,2 (50)	1	1
18,3 (60)	2	1

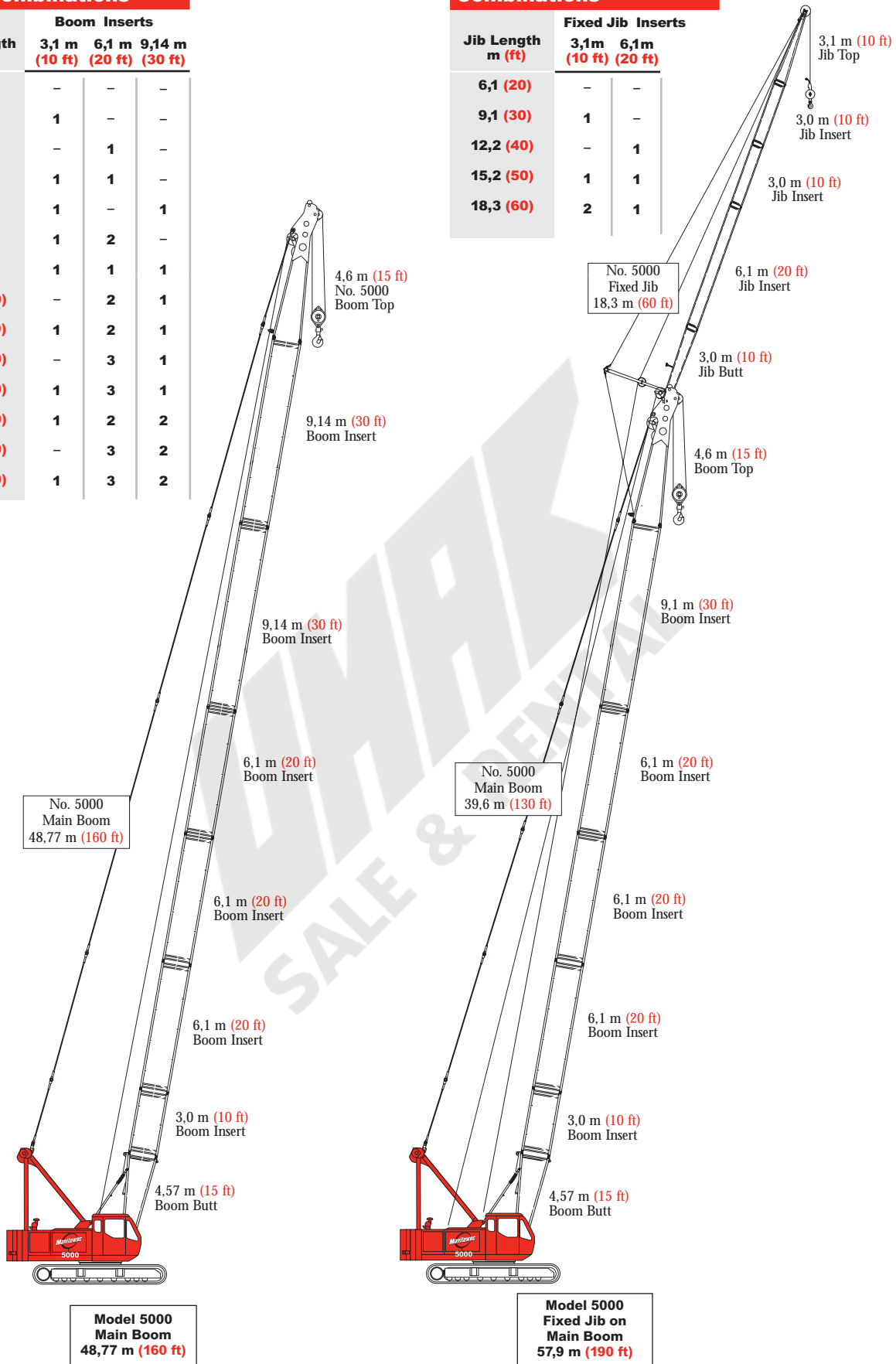

load chart notes

12

- Rated loads included in the charts are the maximum allowable freely suspended loads at a given boom length, boom angle and load radius, and have been determined for the machine standing level on firm supporting surface under ideal operating conditions. The user must limit or de-rate rated loads to allow for adverse conditions (such as soft or uneven ground, out-of-level conditions, wind, side loads, pendulum action, jerking or sudden stopping of loads, inexperience of personnel, multiple machine lifts, and traveling with a load).
- Maximum rated single line pull is 12,566 lb. at 221 FPM when using one to seven parts of line, 13,800 lb. with eight parts of line.
- Capacities do not exceed 75% of minimum tipping loads. Capacities based on factors other than machine stability such as structural competence are shown by asterisk * in the charts located in the operator's crane cab.
- The machine must be reeved and set-up as stated in the operation manual and all the instruction manuals if these manuals are missing, obtain replacements. Boom backstops are required for all boom lengths. Gantry must be fully raised position for all operations. Crawlers must be fully extended and be locked in position. The crane must be leveled to within 1% on a firm supporting surface. Do not attempt to lift where no radius or load is listed as crane may tip or collapse.
- Attempting to lift more than rated loads may cause machine to tip or collapse. Do not tip machine to determine capacity.
- Weight of hooks, hook blocks, slings and other lifting devices are a part of the total load. Their total weight must be subtracted from the rated load to obtain the weight that can be lifted.
- When lifting over boom point with jib or upper boom point installed, rated loads for the boom must be deducted as shown below.

Jib length	Upper Boom Point	20'	30'	40'	50'	60'
Deduct (lbs)	330	1,760	1,980	2,200	2,430	2,700

- The total load that can be lifted by the fixed jib is limited by rated fixed jib loads. The total load that can be lifted with the upper boom point is limited by the rated upper boom point loads.
- Boom lengths for jib mounting are 90 ft (27,43 m) to 130 ft (39,62 m).
- An upper boom point cannot be used on a 160 ft (48,77 m) boom length.

- The boom should be erected over the front of the crawlers, not laterally
- Least stable position is over the side.
- Maximum hoist load for number of reeving parts of line for hoist rope.

Maximum Load for Main Boom

No. of Parts of Line	1	2	3	4
Maximum Loads (lbs)	12,566	25,132	37,698	50,264

No. of Parts of Lines	5	6	7	8
Maximum Loads (lbs)	62,830	75,396	87,962	100,000

Maximum Load for Fixed Jib

No. of Parts of Line	1
Maximum Loads (lbs)	11,000

Maximum Load for Upper Boom Point

No. of Parts of Line	1
Maximum Loads (lbs)	12,000

- Lifting capacities listed apply only to the machine as originally manufactured for and supplied by Manitowoc Cranes, Inc. Modifications to this machine or use of equipment other than that specified can reduce operating capacity.
- Designed and rated to comply with ANSI Code B30.5.

Operation of this equipment in excess of rated loads or disregard of instruction voids the warranty.

heavy-lift boom range diagram

No. 5000 Heavy-Lift Boom

13

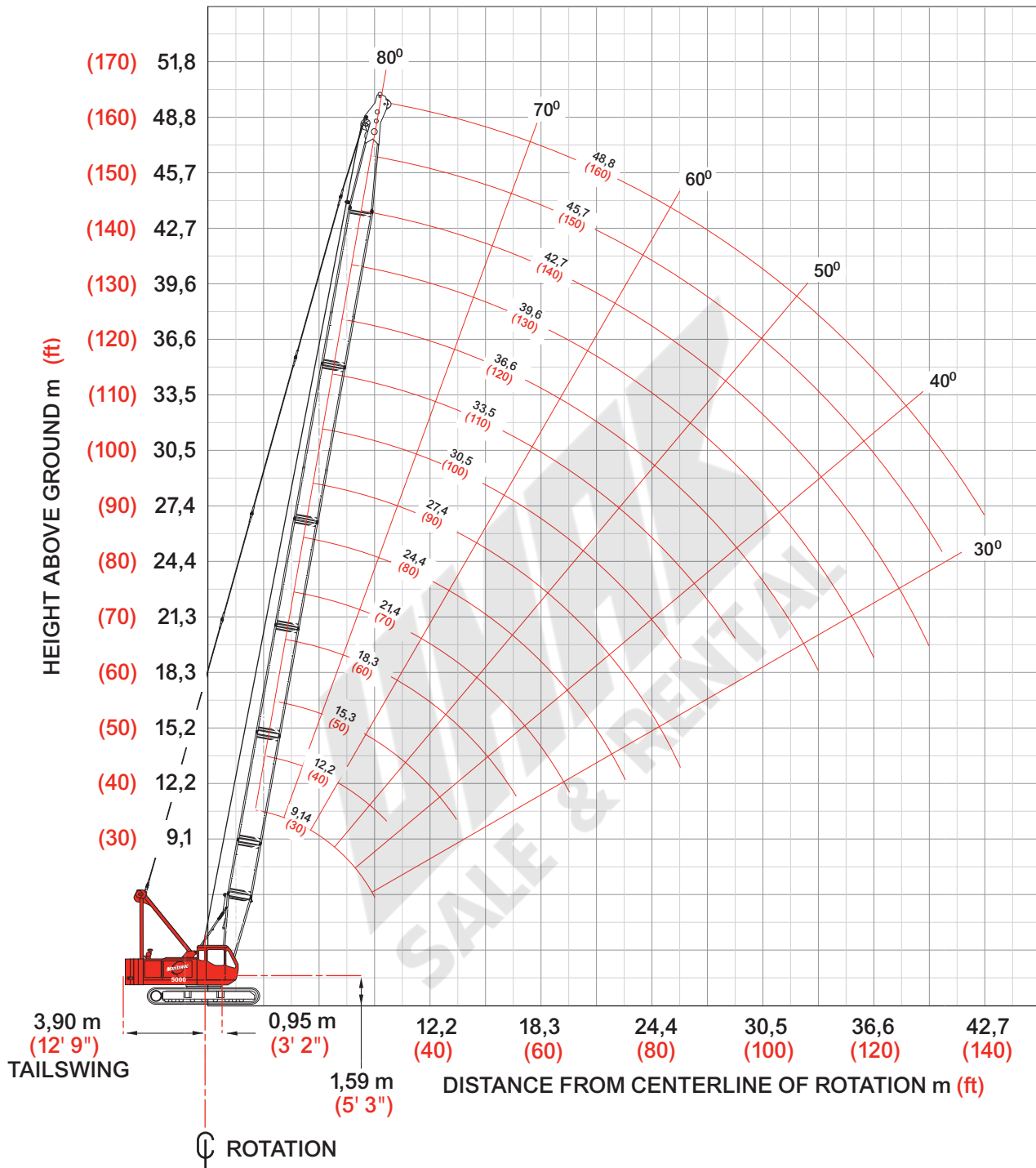

heavy-lift load charts

14

Liftcrane Boom Capacities No. 5000 Heavy-Lift Boom

33,951 lb Counterweights (3 Upper Counterweights, Crawlers Extended)

360° Rating

lb x 1 000

Boom ft	30	40	50	60	70	80	90	100	110	120	130	140	150	160
Radius														
12	100.0	100.0												
14	85.6	85.6	85.6											
16	74.1	74.1	74.1	72.2										
18	63.2	63.0	62.8	62.6	62.5	57.6								
20	53.7	53.4	53.3	53.1	53.0	52.8	50.1							
24	41.1	40.9	40.7	40.5	40.4	40.2	40.0	39.9	38.0					
28	33.2	33.0	32.8	32.6	32.4	32.3	32.1	31.9	31.8	31.7	29.0			
30	28.1	30.0	29.8	29.6	29.5	29.3	29.1	29.0	28.8	28.7	28.3	25.3	23.8	
45			17.4	17.2	17.0	16.8	16.6	16.5	16.3	16.2	16.0	15.8	15.8	15.5
55				13.2	13.0	12.8	12.6	12.4	12.3	12.2	11.9	11.8	11.7	11.5
65					10.4	10.1	9.9	9.8	9.6	9.5	9.3	9.1	9.0	8.8
75						8.3	8.1	7.9	7.7	7.6	7.4	7.2	7.1	6.9
85							6.7	6.5	6.3	6.2	6.0	5.8	5.7	5.5
95									5.3	5.1	4.9	4.7	4.6	4.4
110										3.9	3.7	3.5	3.4	3.1
120											3.1	2.9	2.7	2.5
130												2.4	2.2	2.0
140														1.5



Meets ANSI B30.5 Requirements - Capacities do not exceed 75% of static tipping load.
NOTICE: This capacity chart is for reference only and must not be used for lifting purposes.

fixed jib range diagram

No. 5000 Fixed Jib

15

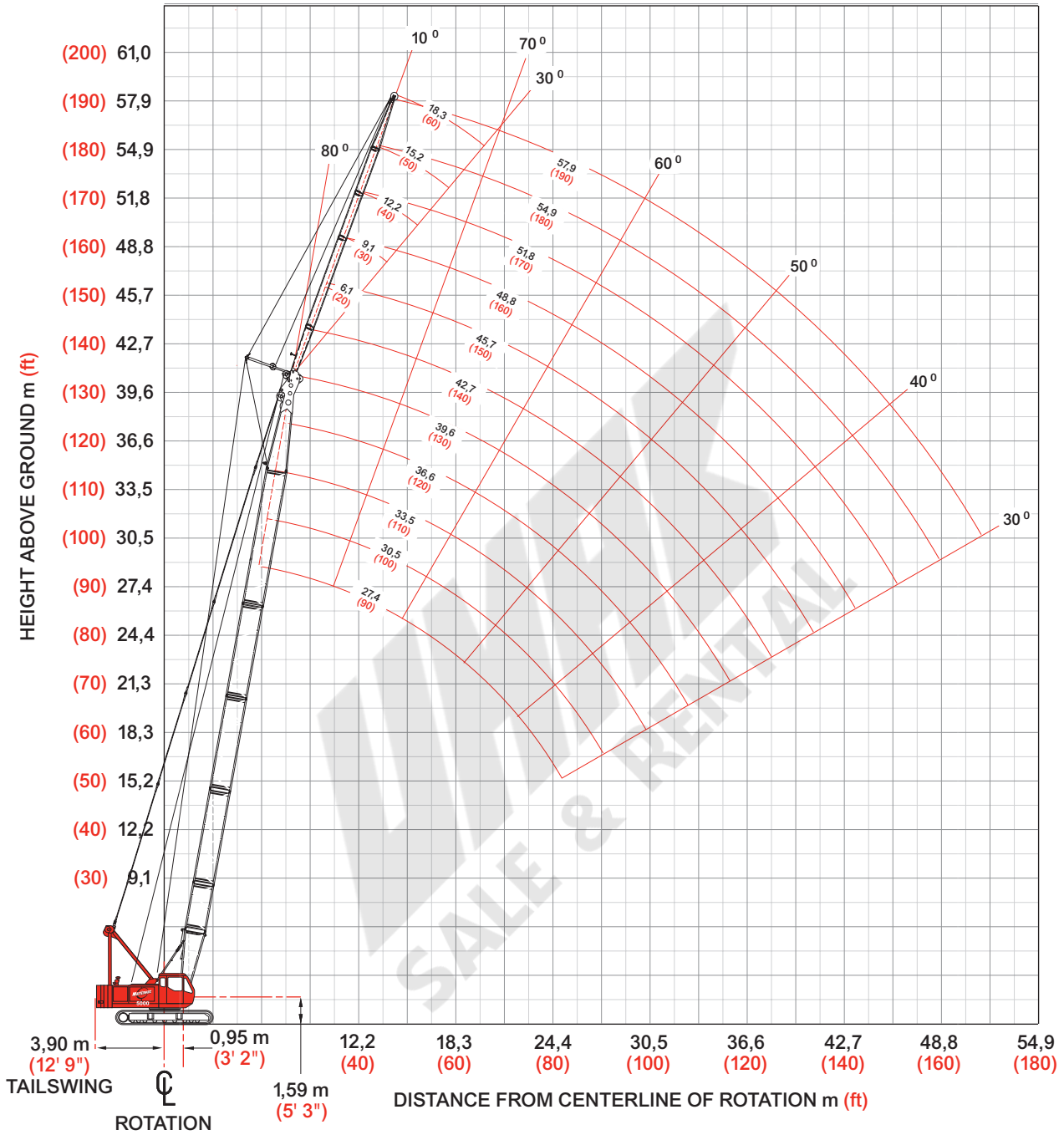

fixed jib load charts

16

Liftcrane Jib Capacities No. 5000 Fixed Jib on Main Boom

33,951 lb Counterweights (3 Upper Counterweights, Crawlers Extended)

360° Rating

lb x 1 000

10' Offset

30' Offset

Boom ft	90	100	110	120	130
Radius					
30	11.0	11.0			
40	11.0	11.0	11.0	11.0	11.0
50	11.0	11.0	11.0	11.0	11.0
60	10.2	10.0	9.9	9.7	9.5
70	7.9	7.7	7.6	7.2	7.1
80	6.2	6.0	5.9	5.6	5.3
90	5.0	4.6	4.4	4.2	3.9
95	4.4	4.0	3.8	3.6	3.3
100		3.5	3.3	3.0	2.8
110			2.4	2.1	1.9

Boom ft	90	100	110	120	130
Radius					
30					
40	9.9	9.9	9.9	9.9	
50	9.9	9.9	9.9	9.9	9.9
60	9.8	9.8	9.7	9.7	9.7
70	8.2	7.9	7.8	7.7	7.5
80	6.4	6.2	6.1	6.0	5.6
90	5.1	4.7	4.6	4.4	4.2
95	4.4	4.1	4.0	3.8	3.5
100		3.6	3.5	3.2	2.9
110			2.5	2.2	2.0

Boom ft	90	100	110	120	130
Radius					
30					
40	11.0	11.0	11.0	11.0	11.0
50	11.0	11.0	11.0	11.0	11.0
60	10.5	10.3	10.1	10.0	9.8
70	8.2	8.0	7.9	7.7	7.5
80	6.5	6.3	6.2	6.0	5.6
90	5.2	4.9	4.8	4.5	4.2
95	4.6	4.4	4.1	3.9	3.6
100		3.8	3.6	3.4	3.0
110		2.9	2.7	2.4	2.1

Boom ft	90	100	110	120	130
Radius					
30					
40					
50	9.0	9.0	9.0	9.0	
60	9.0	9.0	9.0	9.0	9.0
70	8.4	8.3	8.2	8.1	7.9
80	6.8	6.6	6.5	6.3	6.2
90	5.4	5.2	5.1	4.9	4.6
95	4.8	4.6	4.5	4.3	4.0
100	4.2	4.0	3.9	3.7	3.4
110		3.0	2.9	2.6	2.4

fixed jib load charts

Liftcrane Jib Capacities No. 5000 Fixed Jib on Main Boom

33,951 lb Counterweights (3 Upper Counterweights, Crawlers Extended)

360° Rating

lb x 1 000

17

10' Offset

30' Offset

Jib 50 ft	Boom ft	90	100	110	120	130
	Radius					
	40	7.0	7.0			
	50	6.7	6.9	6.9	6.9	7.0
	55	6.5	6.7	6.7	6.8	7.0
	60	6.4	6.6	6.6	6.6	6.8
	70	6.0	6.2	6.2	6.3	6.5
	80	5.8	5.9	6.1	5.8	6.0
	90	5.5	5.4	5.2	4.9	4.6
	95	5.1	4.8	4.6	4.2	4.0
	100		4.2	4.0	3.7	3.5
	110		3.3	3.1	2.8	2.5

Jib 50 ft	Boom ft	90	100	110	120	130
	Radius					
	40					
	50					
	55	5.0				
	60	5.0	5.0	5.0	5.0	5.0
	70	5.0	5.0	5.0	5.0	5.0
	80	5.0	5.0	5.0	5.0	5.0
	90	5.0	5.0	5.0	5.0	5.0
	95	5.0	4.9	4.9	4.8	4.7
	100	4.9	4.6	4.6	4.3	4.1
	110	3.9	3.6	3.4	3.2	3.0

Jib 60 ft	Boom ft	90	100	110	120	130
	Radius					
	40					
	50	4.9	4.9	4.9		
	55	4.8	4.8	4.8	4.8	4.8
	60	4.6	4.6	4.6	4.8	4.8
	70	4.3	4.3	4.5	4.5	4.5
	80	3.9	4.1	4.1	4.2	4.3
	90	3.7	3.8	4.0	3.9	4.0
	95	3.6	3.7	3.9	3.8	3.9
	100	3.5	3.6	3.7	3.7	3.7
	110	3.3	3.3	3.2	3.0	2.7

Jib 60 ft	Boom ft	90	100	110	120	130
	Radius					
	40					
	50					
	55					
	60	3.4	3.4			
	70	3.4	3.4	3.4	3.4	3.4
	80	3.4	3.4	3.4	3.4	3.4
	90	3.4	3.4	3.4	3.4	3.4
	95	3.4	3.4	3.4	3.4	3.4
	100	3.3	3.3	3.3	3.3	3.4
	110	3.2	3.2	3.2	3.2	3.3

Meets ANSI B30.5 Requirements - Capacities do not exceed 75% of static tipping load.
NOTICE: This capacity chart is for reference only and must not be used for lifting purposes.

clamshell

18

Boom:

Welded lattice construction using tubular, high-tensile steel chords with pin connections between sections.

Basic boom length: 30 ft (9,14 m)

Max. boom length: 60 ft (18,3 m)

Limit on clamshell bucket weight: 4,600 lbs (2 100 kg)

Boom Component Chart

Boom length ft (m)	Boom arrangement
30 (9,1)	Butt-Top
40 (12,2)	Butt-A-Top
50 (15,2)	Butt-B-Top
60 (18,3)	Butt-A-B-Top

Butt = 15 ft (4,57 m)

Insert: A = 10 ft (3,05 m)

B = 20 ft (6,10 m)

Top = 15 ft (4,57 m)

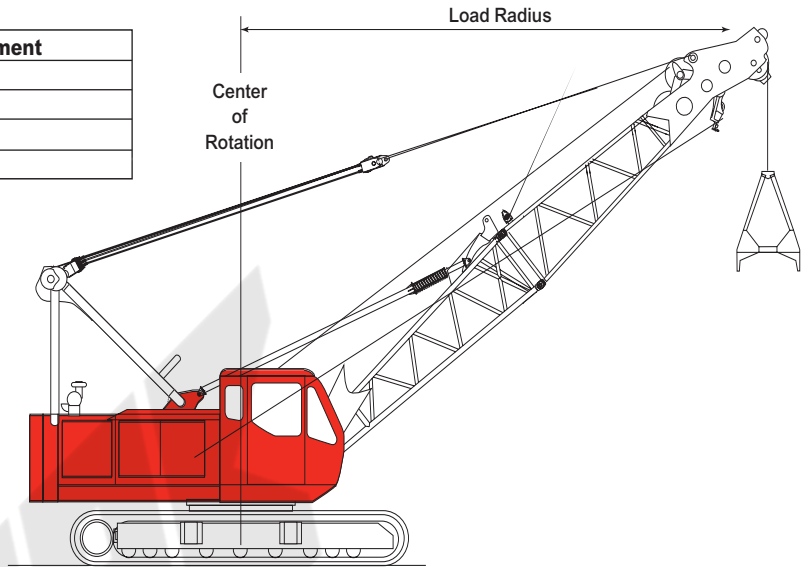

Clamshell Capacities

22,045 lb Counterweight (2 Upper Counterweights, Crawlers Extended)

lb x 1 000

Boom ft	30	40	50	60
Radius				
18	15.5			
20	15.5			
24	15.5	15.5		
28	15.5	15.5	15.5	
32		15.5	15.5	15.5
34		15.5	15.5	15.5
36		15.5	15.5	15.5
40			14.3	14.1
45				12.0
50				10.4

Notes: Figures represent maximum allowable capacity, and assume level, firm ground and ideal working conditions. Capacities are calculated at 67.5% of the minimum clamshell tipping load. Capacities are the maximum recommended by PCSA Standard #4. Allowances must be made by the user for such unfavorable conditions as a soft or uneven supporting surface, rapid cycle operations, or bucket suction. The combined weight of the bucket and load must not exceed these capacities. Boom length for clamshell operation should not exceed 60' (18,29 m). Consult your authorized distributor for rated loads during rapid cycle operations.

dragline

19

Boom:

Welded lattice construction using tubular, high-tensile steel chords with pin connections between sections.

Basic boom length: 30 ft (9,14 m)

Max. boom length: 60 ft (18,3 m)

Optional fairlead: Full-revolving type.

Boom Component Chart

Boom length ft (m)	Boom arrangement
30 (9,1)	Butt-Top
40 (12,2)	Butt-A-Top
50 (15,2)	Butt-B-Top
60 (18,3)	Butt-A-B-Top

Butt = 15 ft (4,57 m)

Insert: A = 10 ft (3,05 m)

B = 20 ft (6,10 m)

Top = 15 ft (4,57 m)

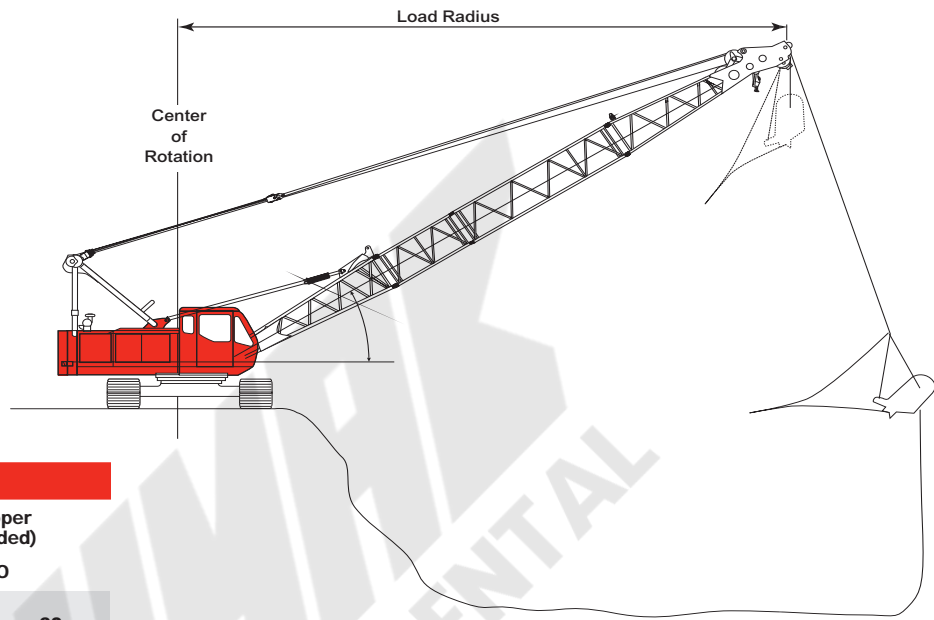

Dragline Capacities

22,045 lb Counterweight (2 Upper Counterweights, Crawlers Extended)

lb x 1 000

Boom ft	30	40	50	60
Radius				
26	15.5			
28	15.5			
30	15.5			
34		15.5		
38		15.5		
42			14.9	
46			13.2	
50				11.6
54				10.5
56				10.0

Notes: Figures represent maximum allowable capacity, and assume level, firm ground and ideal working conditions. Capacities are calculated at 75.0% of the minimum dragline tipping load. Capacities are the maximum recommended by PCSA Standard #4. Allowances must be made by the user for such unfavorable conditions as a soft or uneven supporting surface, rapid cycle operations, or bucket suction. The combined weight of the bucket and load must not exceed these capacities. Do not operate the dragline using boom angles of less than 30 degree. Boom length for dragline operation should not exceed 60' (18,29 m). Consult your authorized distributor for rated loads during rapid cycle operations.



Americas Region

Manitowoc

Telephone Number: + 1 920 684 6621
Fax Number: + 1 920 683 6278
Address: 2401 S. 30th Street,
Manitowoc, WI 54220 USA

Grove, National, Manlift, Potain

Telephone Number: + 1 717 597 8121
Fax Number: + 1 717 593 5929
Address: 1565 Buchanan Trail East,
Shady Grove, PA 17256 USA

Manitowoc Crane Group - Brazil

Telephone Number: (55) 11 3841 2741
Fax Number: (55) 11 3841 2740
Address: Edificio: Itaim Office Tower
Rua Gomes de Carvalho,
1581 - 2 andar cj 205 / 206
Vila Olimpia - SP - Cep: 04547 - 006 Brasil

Grove - Mexico

Fax Number: (5281) 8124 - 0128
Fax Number: (5281) 8124 - 0129
Address: Miravalle Center, piso PB,
Suite 106
Calz San Pedro 250 Nte. Monterrey,
Nuevo Leon, Mexico

EMEA Region

Grove RT & Manitowoc

Telephone number: + 44 191 565 6281
Fax number: + 44 191 515 7475
Address: Akeler House, 1 Emperor Way
Doxford International Business park
Sunderland, England SR3 3XR

Grove GMK

Telephone Number: + 49 4421 294 454
Fax number: + 49 4421 294 244
Address: Industriegelände West
26389 Wilhelmshaven
Postfach 1853, Germany

Potain

Telephone number: + 33 472 182 164
Fax number: + 33 472 182 109
Address: 18 Chemin de Charbonnières
69130 Ecully, France

Manlift - France

Telephone Number: +33 (0) 553 84 85 86
Fax number: +33 (0) 553 84 85 74
Address: Delta Manlift ZI de Fauillet BP 20
F-47400 Tonneins, France

Manlift - Germany

Telephone Number: + 49 (0) 7253 9401 13
Fax number: + 49 (0) 7253 9401 16
Address: Liftflux Potain GmbH
Service und Ersatzteilzentrum
Heidigstrasse 17 D-76709 Kronau, Germany



www.manitowoccranecare.com

Asia/Pacific Region

Singapore

Manitowoc Crane Group Asia PTE LTD
Telephone Number: + 65 686 17133
Fax Number: + 65 686 24040 (Sales/Admin)
+ 65 686 24142 (Parts/Service)
Address: 26 Benoi Road Singapore, 629898
Singapore

China

Zhangjiagang Potain Constr. Machinery
PTE LTD
Telephone Number: + 86 512 5878 0088
Fax number: + 86 512 5878 0098
Address: Wenxingqiaonan Houcheng
Zhangjiagang, Jiangsu 215631 PR China

Manitowoc Crane Group Asia Shanghai Office

Telephone number: + 86 21 6270 0442
Fax number: + 86 21 6270 1436
Address: RM. D-305 Shanghai-Mira
Commercial Centre
No.2633, West Yanan Rd
Shanghai, PR China
Post Code 200336

Manitowoc Crane Group Asia Shanghai Operations Office

Telephone Number: + 86 21 5111 3579
Fax number: + 86 21 5111 3578
Address: Rm1201, #933 Zhongshan West
Road Hongqiao Silver Tower
Shanghai 200051, PR China

Australia

Manitowoc Crane Group Australia
Grove Australia PTY LTD - Melbourne Office
Telephone Number: + 61 3 9336 1076
+ 61 3 9336 1089
+ 61 3 9336 1300
Fax number: + 61 3 9336 1124
+ 61 3 9336 1322

Address: 2/22 Disney Avenue, East Keilor
VIC 3033 Australia

Grove Australia PTY LTD - Sydney Office

Telephone Number: + 61 2 9674 3455
Fax number: + 61 3 9336 1124
+ 61 2 9620 4062
+ 61 2 9674 3466

Address: 1/57 Prince William Drive
Seven Hills NSW 2147 Australia

Korea

Manitowoc Crane Group Korea CO LTD
Telephone Number: + 82 2 508 3361
Fax number: + 82 2 508 3365
Address: Room 301 Gugu Building #145-18
Samsung-Dong, Kangnam-Ku
Seoul 135878 Korea

Philippines

Potain Inc.
Telephone Number: + 63 2 844 9437
+ 63 2 844 9455
+ 63 2 844 9456
Fax number: + 63 2 844 4712
Address: G/F Southwest Centre Building
cor Makiling Street South Super
Highway Palanan, Makati City
Philippines