

MANITOWOC RINGER 4600 Series-4
60-Foot Diameter
PLATFORM-RINGER™
(U.S. and Foreign Patents Applied For.)
SPECIFICATIONS

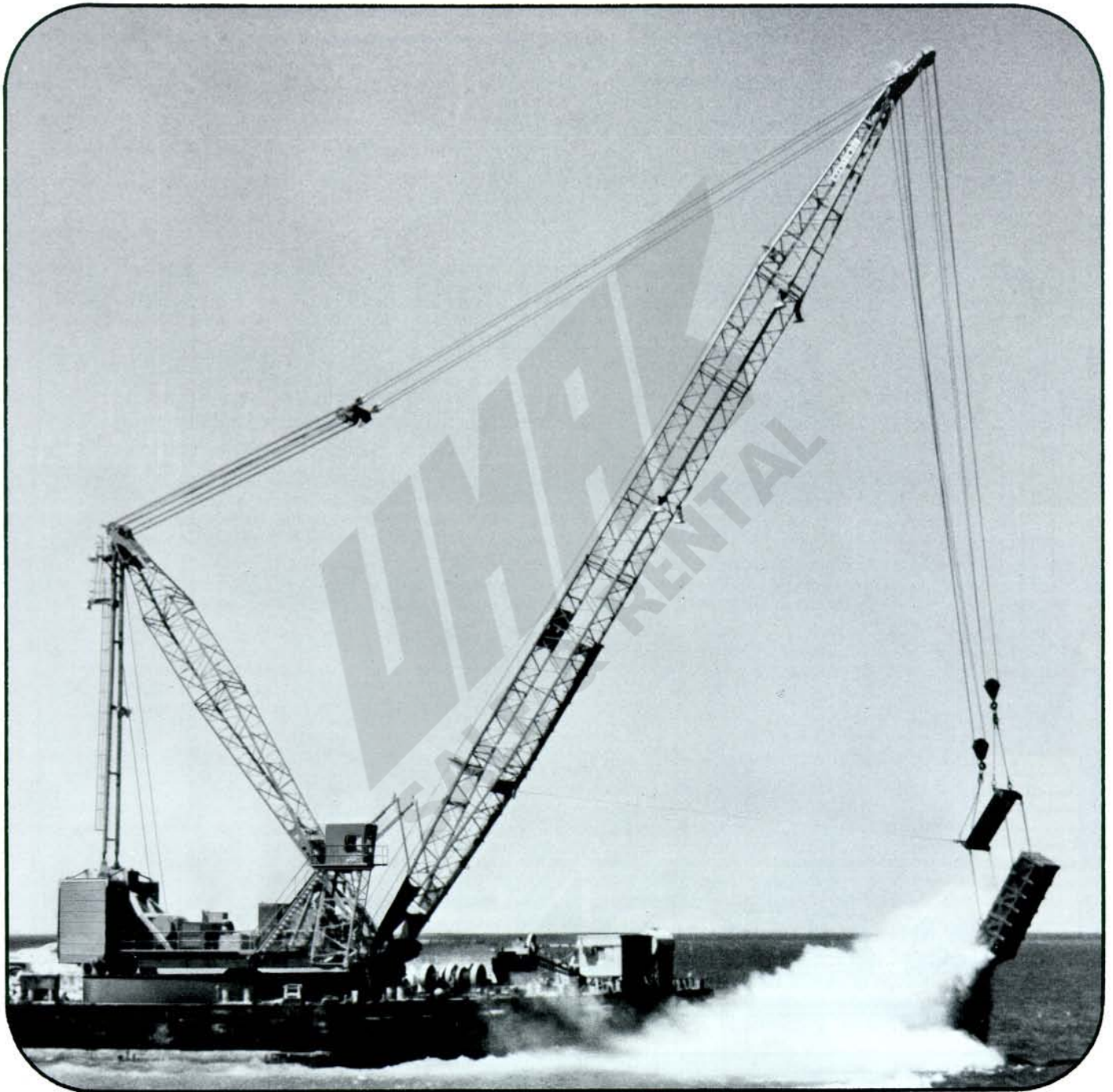

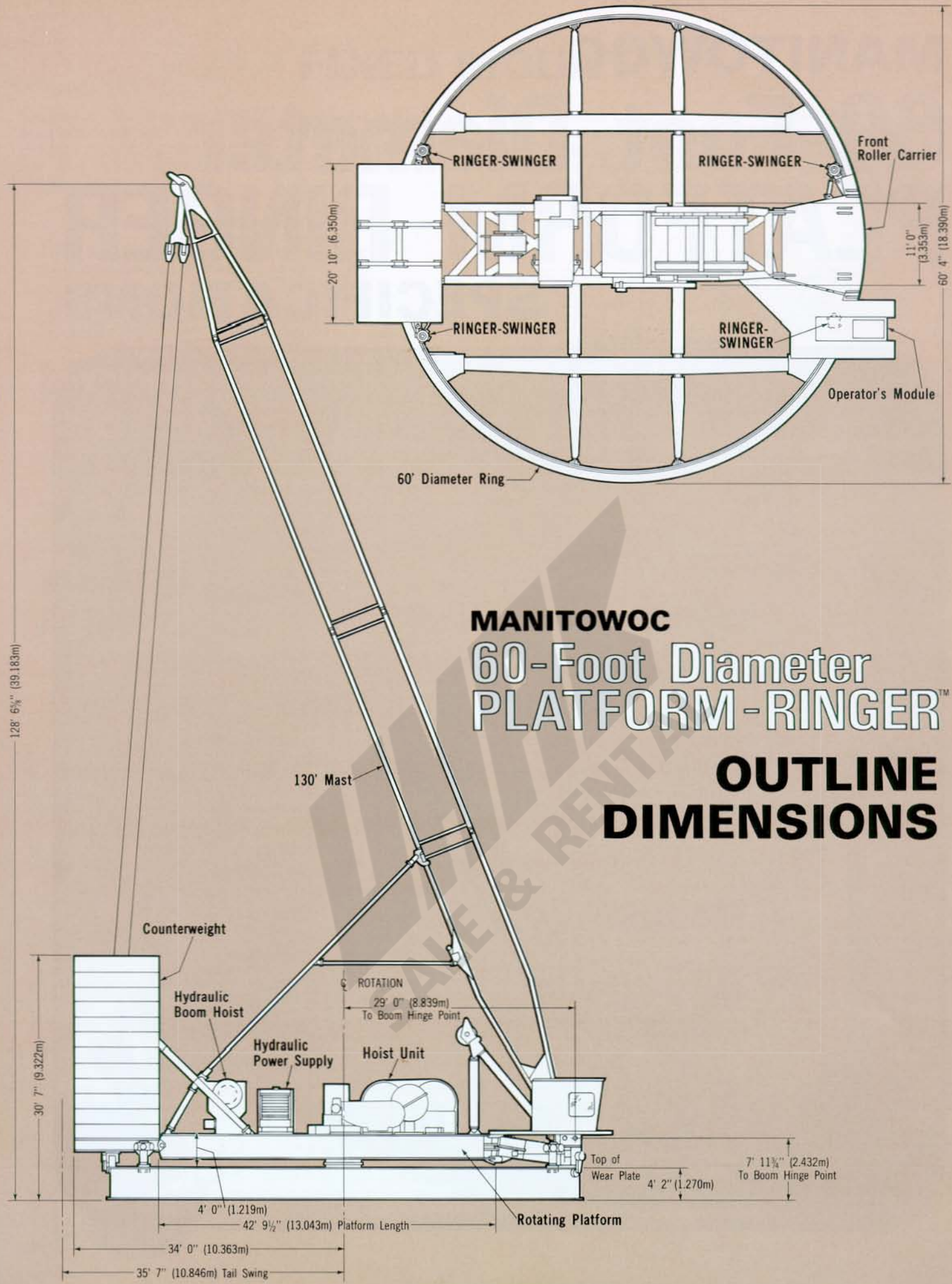

128' 6 5/8" (39.183m)

20' 10" (6.350m)

11' 0" (3.353m)
60' 4" (18.390m)

MANITOWOC 60-Foot Diameter PLATFORM-RINGER™

OUTLINE DIMENSIONS

130' Mast

Counterweight

Hydraulic
Boom Hoist

Hydraulic
Power Supply

ROTATION
29' 0" (8.839m)
To Boom Hinge Point

Hoist Unit

Top of
Wear Plate

7' 11 1/4" (2.432m)
To Boom Hinge Point

30' 7" (9.322m)

4' 0" (1.219m)

42' 9 1/2" (13.043m) Platform Length

Rotating Platform

34' 0" (10.363m)

35' 7" (10.846m) Tail Swing

RINGER-SWINGER

RINGER-SWINGER

Front
Roller Carrier

RINGER-SWINGER

RINGER-SWINGER

Operator's Module

60' Diameter Ring

RINGER® ATTACHMENT — Assembly and Erection
4600 Series-4, RINGER Series-3 with No. 65 Boom

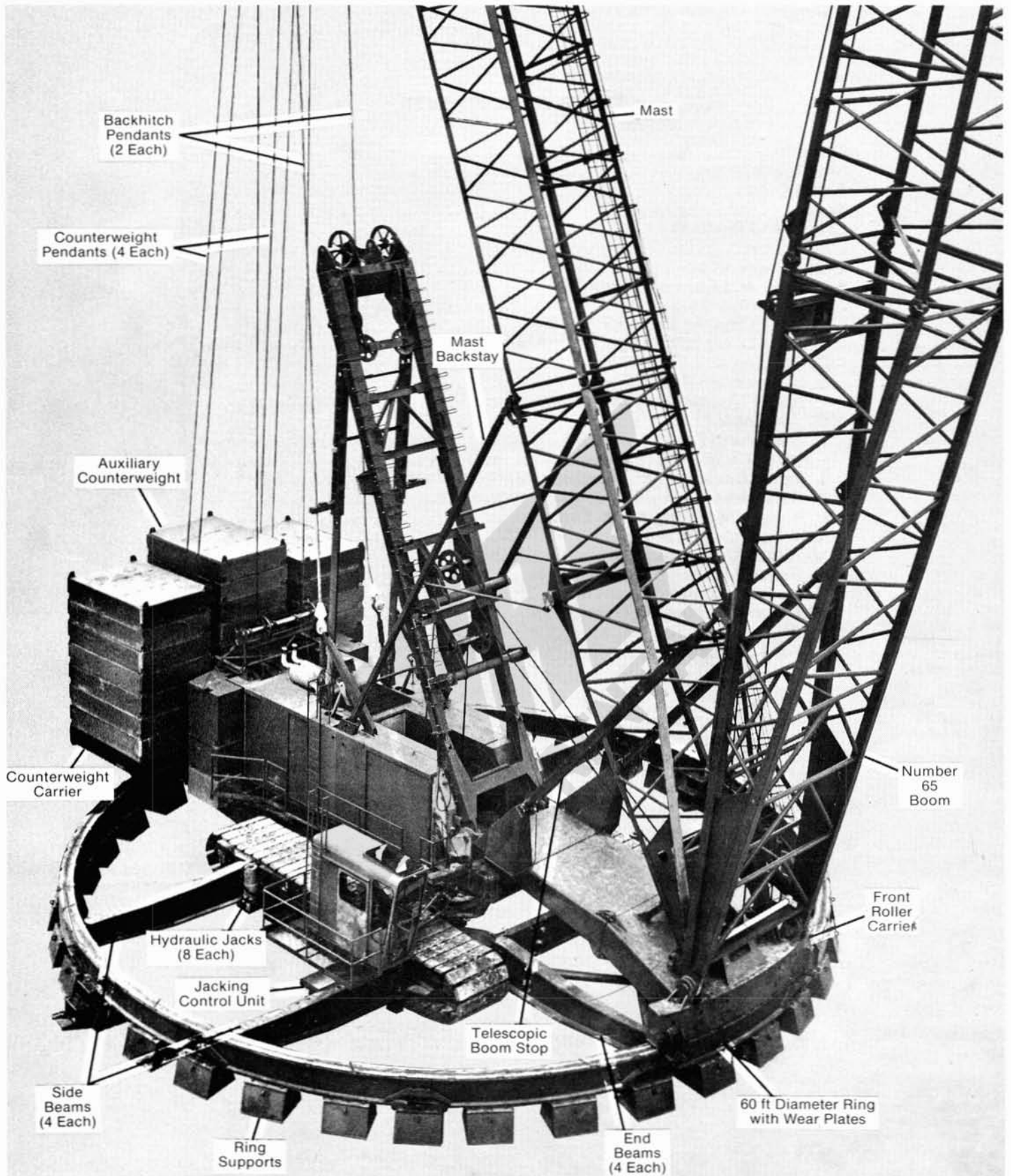

WEIGHTS

	POUNDS*		POUNDS*
60' DIAMETER RING , 4 segments with wear plates (each 30,945).....	123,780	GUIDE SHEAVE SUPPORT AND TELESCOPIC BOOM STOPS	16,100
RING SIDE BEAMS , 2 beams (each 30,000) ..	60,000	MAST AND BACKHITCH , 130' No. 27B mast with pendant backhitch	47,500
INTERMEDIATE SUPPORT BEAMS , 4 beams (each 7,800).....	31,200	OPERATOR'S MODULE , complete with all operating controls, mounting bracket and catwalk	6,000
FRONT ROLLER CARRIER , with 6 house rollers and 4 hook rollers.....	25,000	BOOM NO. 38	
ROTATING PLATFORM , with 2-drum 560 Hoist and hydraulic boom hoist	110,500	BOOM BUTT: (less wire rope and pendants) ..	18,910
RINGER-SWINGER ATTACHMENTS , with positioners (each 1,500).....	6,000	BOOM TOP: (equipped with ten sheave lower boom point).....	29,675
COUNTERWEIGHT CARRIER	42,100	Add for 10' integral single sheave upper boom point	3,260
REMOVABLE COUNTERWEIGHT (29-PC)		Total	32,935
Left Stack (12 boxes, each 40,000).....	480,000	BOOM INSERTS:	
Center Stack (5 boxes, each 40,000).....	200,000	Insert—20' (with pendants & wire rope guide) ..	7,150
Right Stack (12 boxes, each 40,000).....	480,000	Insert—40' (with pendants & wire rope guides) ..	12,165
Total	1,160,000		

*Weights are approximate and may vary between machines as a result of design changes and component variations.

60-FOOT DIAMETER RING ASSEMBLY

RING SEGMENTS: Fabricated, reinforced I-beam construction. Four ring segments (front, rear and two sides) are bolt-connected for fast installation and removal.

WEAR PLATES: Twelve ¾" abrasion resistant plates cut to fit on top of ring segments to protect them from wear. Attached to ring by retainer plates designed to clear hook roller hanger assembly.

RING SIDE BEAMS: Two fabricated deep section beams pin-connected to ring and king pin support structure. Four hydraulic jacks mounted on ends of side beams.

INTERMEDIATE SUPPORT BEAMS: Four fabricated beams pin-connected to ring and side beams.

RING GEAR: Sixteen segments bolt-connected to ring.

ROTATING STRUCTURE

ROTATING PLATFORM: Fabricated deep box section side rails with lattice-type supports form a mounting platform for machinery components. Catwalks and railings provided along both sides of platform. Platform is centered on king pin support frame through king pin.

KING PIN SUPPORT FRAME: Fabricated frame pin-connected to ring side beams provides support for king pin. King pin provides concentricity between rotating platform and 60' diameter ring. King pin takes horizontal load only, no uplift. Support frame is sized to fit on top of 6000W transporter for pin connecting to transporter's transverse beams.

FRONT ROLLER CARRIER: Fabricated deep box section construction with 6 house rollers and 4 hook rollers, all antifriction bearing mounted. Provides lugs for boom and mast hinge pins and guide sheave supports. Pin-connected to front end of rotating platform.

OPERATOR'S MODULE: Steel construction, indepen-

dently mounted on front roller carrier, fully enclosed and insulated. Includes operating controls for load hoist, boom hoist and swing; safety glass windows, cab heater, windshield wiper, horn, defogging fan and catwalks and railings. Optional elevated cab available.

COUNTERWEIGHT CARRIER: Fabricated tray pin-connected to rear of rotating platform. Supports 1,160,000 pounds of counterweight.

COUNTERWEIGHT ROLLERS: Four sets of dual equalized support rollers and two sets of dual hook rollers mounted under counterweight carrier. Rollers are antifriction bearing mounted.

RINGER COUNTERWEIGHT: 1,160,000 pounds. Optional interlocking steel boxes filled with scrapcrete (consisting of 29 boxes weighing 40,000 pounds each). Counterweight boxes can be fabricated and filled by others to Manitowoc Engineering Co. specifications.

MACHINERY COMPONENTS

LOAD HOIST: VICON® (Variable Independent CONTROL — Patented) model 560 Hoist with power plant for load and whip lines. Available with either 1 or 2 drum shafts. Full width front drum and full width or split rear drum provides maximum versatility in meeting specific application requirements. Hoist includes VICON power load lowering, radiator, engine shroud, fully enclosed gears and drive chains, antifriction bearing drum journals, electric starting, instrument panel and air controls in operator's module. Full Width Drums — 28" in diameter x 55" wide with 66" diameter flanges. Split Drums — Right Drum 28" in diameter x 31 $\frac{1}{16}$ " wide with 66" diameter flanges; Left Drum 28" in diameter x 14 $\frac{5}{16}$ " wide with 66" diameter flanges. Dual, air actuated drum brakes are spring set, air released, air applied. Single, air actuated drum clutches.

INDEPENDENT BOOM HOIST: Dual drums driven by alloy steel worm shaft and bronze worm gear through gear and pinion reduction. All rotating shafts antifriction bearing mounted. Boom hoist powered by variable displacement hydraulic motor providing full range speed control. Boom hoist brake, external contracting band-type, spring applied, air released. Auxiliary brake, external contracting band-type, set from operator's module. Ratchet on boom hoist drum flange with pawl mounted on gear housing. Boom hoist pin-connected to rear of rotating platform.

TELESCOPIC BOOM STOPS: Telescoping tubes, air cushioned. Pin-connected to boom butt and top of guide sheave support.

POWER PLANTS: See page 5.

THE RINGER-SWINGER™

The swing function for the 60' diameter PLATFORM-RINGER is performed by Manitowoc's exclusive, patented RINGER-SWINGER system. This fully modulated, hydraulically powered system provides swing acceleration or deceleration in either direction. Operation is controlled by a single lever and full, free-float exists when lever is in neutral position.

The system utilizes four RINGER-SWINGER units. Two RINGER-SWINGERS are mounted one on either side of the front roller carrier with two additional units mounted one on either side of the counterweight carrier. A hydraulic motor powers a direct drive pinion which is held in constant contact against an internal ring gear by hydraulic and spring positioners. A drive pinion flange and gear segment skirt maintains pitch control between pinion and ring gear.

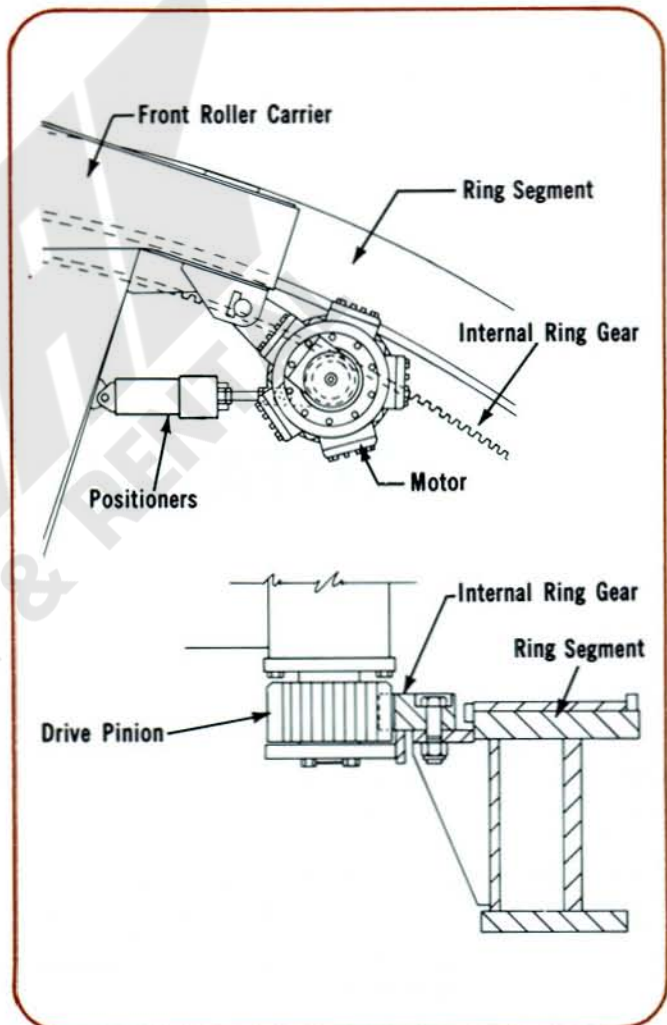
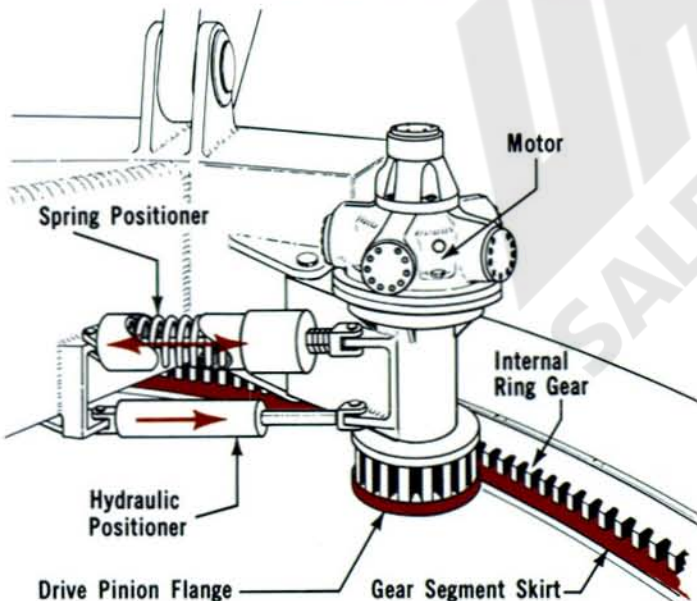

POWER PLANT OPTIONS

MODEL 560 HOIST POWER	Cylinder	Bore	Stroke	Cubic Inch Displacement	Net HP @ RPM (at flywheel)
Cummins KT-1150-C450	6	6.25"	6.25"	1,150	450 @ 2,000
Caterpillar 3408 PC-TA	8	5.40"	6.00"	1,099	460 @ 2,000
G. M. 12V-71N	12	4.25"	5.00"	852	410 @ 2,000
HYDRAULIC POWER					
Cummins KT-1150-C450	6	6.25"	6.25"	1,150	450 @ 2,000
Caterpillar 3408 DIT	8	5.40"	6.00"	1,099	390 @ 2,000
G. M. 12V-71N	12	4.25"	5.00"	852	410 @ 2,000
Combined Fuel Tank Capacity: 900 Gallons.					

DRUMS AND LAGGINGS

Model 560 Hoist

Application	Drum	Diameter	Drum Width	Type of Lagging	Diameter of Flange
2-DRUM HOIST					
LIFTCRANE Hoist Whip	Front	28.0"	55.0"	Plain Plain	66.0"
	Rear	28.0"	55.0"		66.0"
OPTIONAL 3-DRUM HOIST					
LIFTCRANE Hoist Whip Auxiliary	Front	28.0"	55.0"	Plain Plain Plain	66.0"
	Right Rear	28.0"	31.8125"		66.0"
	Left Rear	28.0"	14.625"		66.0"

NOTE: Drum diameters are root diameters.

FRONT END EQUIPMENT

NO. 38 BOOM: 50' boom butt, 50' open throat top, 20' and 40' inserts. All welded construction. Triangular boom with box section chords and tubular lacings; 100,000 PSI yield steel. Lower boom point equipped with ten 47" OD antifriction bearing mounted sheaves. Basic boom length 140'; maximum boom length 300'.

FIXED MAST: Consists of 130' No. 27B boom components including 40' butt, 30' insert, 40' insert and 20' mast top.

BACKSTAY STRUT: Two-piece, box section construction. Supports mast when boom hoist lines are slack.

MAST BACKSTAY PENDANTS: Four swaged 2 $\frac{5}{8}$ " structural strand pendants.

BOOM RIGGING: Eighteen-part line reeved between fixed mast and boom equalizer. Controls boom angle by single line continuously reeved from dual independent boom hoist drums which power boom up and down. Two sets of four 1 $\frac{3}{8}$ " pendants connect equalizer to boom point.

EQUALIZER: Steel fabrication. Eight vertical sheaves antifriction bearing mounted.

WIRE ROPE GUIDE: Mounted on boom. Two vertical sheaves bronze bearing mounted.

WIRE ROPE ROLLER GUIDE: Mounted inside boom on bottom chord members. Induction hardened tubing. Antifriction bearing mounted.

UPPER BOOM POINT: Optional. 10' integral upper boom point pin-connected to open throat top. Single 32" OD sheave, antifriction bearing mounted. 25-ton maximum capacity with one-part line; 50-ton maximum capacity with two-part line.

FOR CAPACITY CHARTS AND INFORMATION, CONSULT FACTORY.

NO. 27 AB JIB: Optional. 264-ton maximum capacity. 80' length extendible to 120' with 20' inserts. Jib offset angle fixed at 6 degrees. Top section equipped with eight 32" OD roller bearing sheaves. Wire rope guide and anchor for multiple part line.

CONSULT JIB LIFTING CAPACITY CHARTS FOR SPECIFIC CAPACITY WHEN USED ON VARIOUS BOOM LENGTHS.

FIXED MOUNT

Manitowoc's 60' diameter PLATFORM-RINGER is adaptable to provide high capacity lifting capability for barge, pedestal or gantry applications. The fixed mount eliminates the need for ring side beams. Only a king pin support is required.

The 60' diameter ring can be directly mounted on top of its support structure and secured by a clamp arrangement. The ring can also be supported on blocking or steel pedestals that are equally spaced under the ring and at its four segment joints.

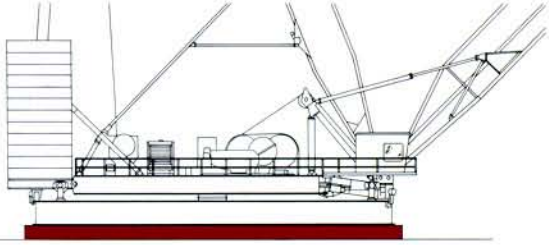

PEDESTAL MOUNT

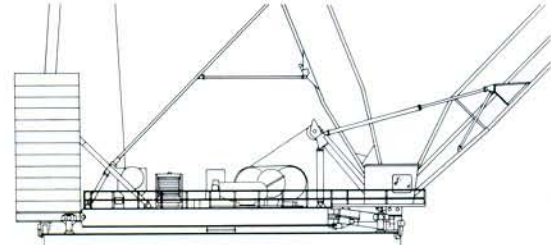

GANTRY MOUNT

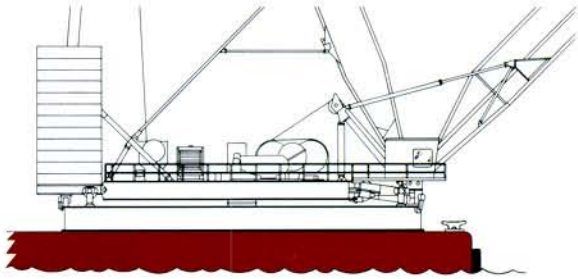

BARGE MOUNT

MOBILE MOUNT

For even greater versatility, Maniowoc's 60' diameter PLATFORM-RINGER can be crawler-transporter mounted to provide the mobility needed to move the PLATFORM-RINGER from lift to lift. The crawler-transporter can then be removed and utilized as a 600-ton capacity transporter while the PLATFORM-RINGER remains available for lift work.

This method of mounting requires two ring side beams and a king pin support frame that is sized to fit on top of the transporter's transverse beams. The ring is supported in a conventional manner using blocking or steel pedestals.

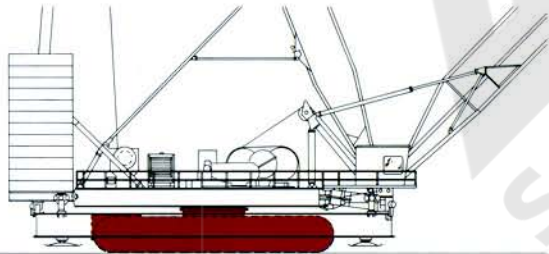

CRAWLER-TRANSPORTER

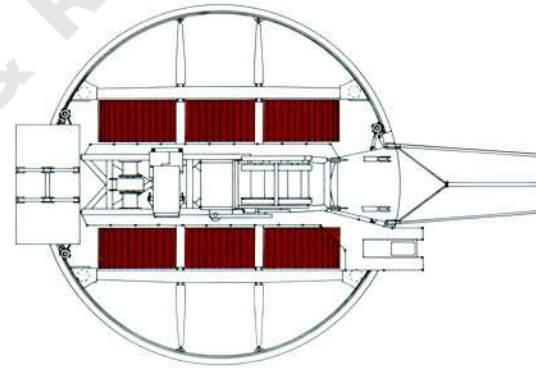

Because of a program of continuing improvements, Maniowoc Engineering Co. reserves the right to change this description at any time, without notice.



MANITOWOC ENGINEERING CO.
(A division of The Maniowoc Company, Inc.)
Maniowoc, Wisconsin 54220

MANITOWOC SPECIFICATIONS

4600 S-4

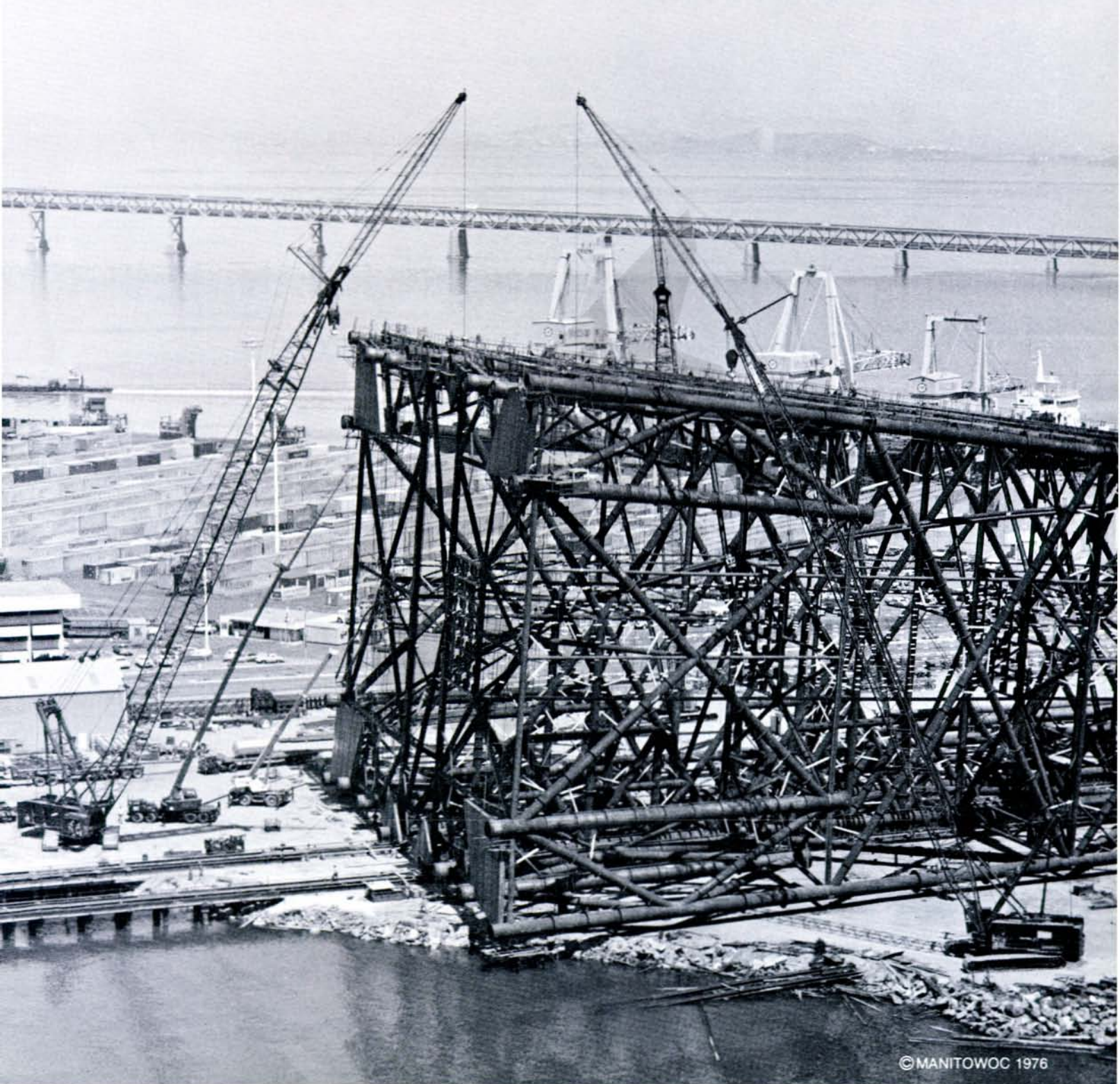

OUTLINE DIMENSIONS

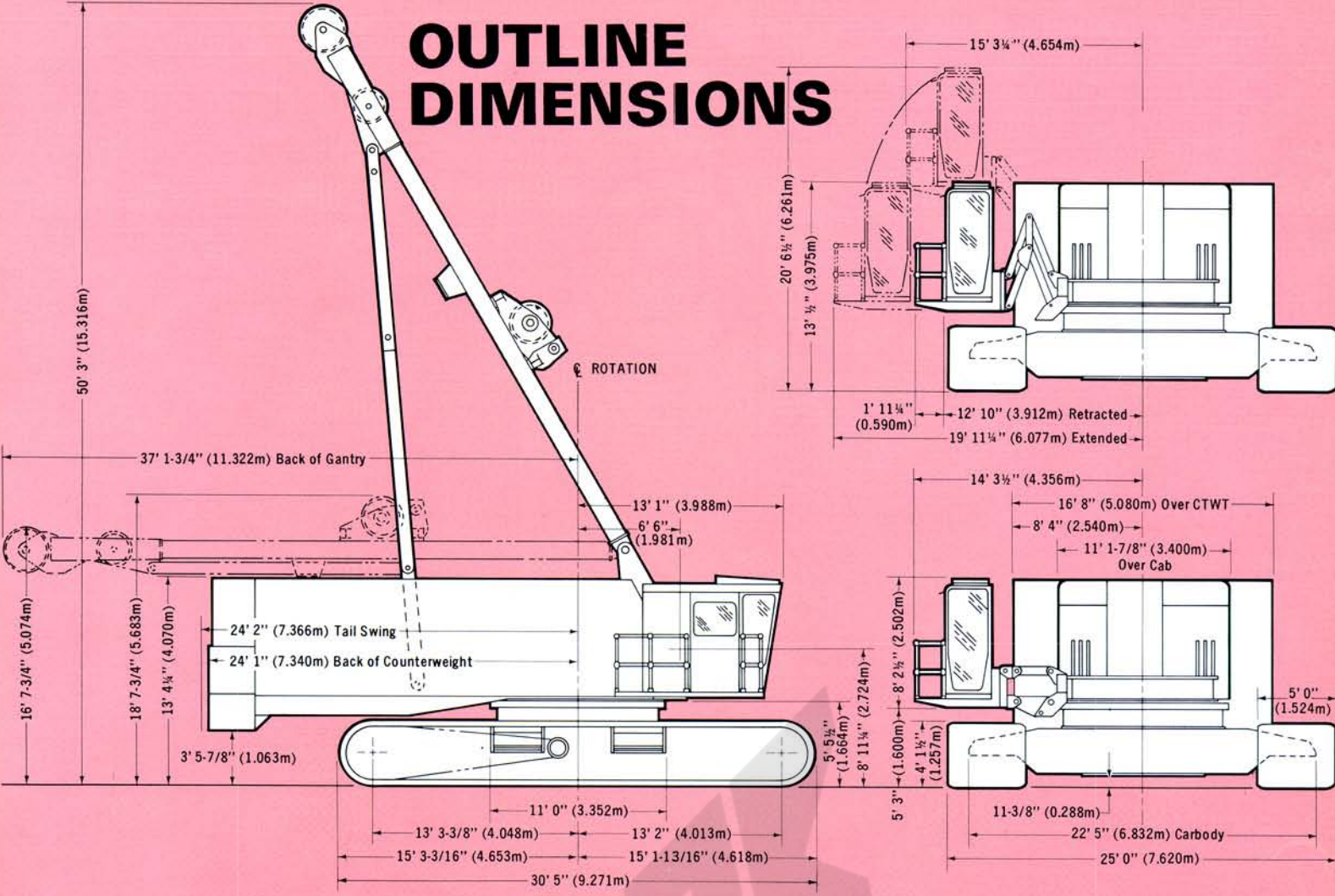

WEIGHTS

- LIFTCRANE**, complete with 80' No. 27B Boom, gantry and backhitch, boom hoist rigging, pendants, basic upperworks package, operator's module, counterweights, 30' 5" long crawlers with 60" treads and outside crawler drive..... 561,500
- CRAWLERS**, with crawler side frames, 60" crawler treads and outside crawler chains (each 66,700) 133,400
- CARBODY**, with king pin, roller path and travel mechanism, without crawlers..... 85,600
- UPPERWORKS**, complete with basic machinery, including main drums but not including boom hoist, gantry and backhitch, operator's module, front end attachments or counterweights..... 138,200
- GANTRY AND BACKHITCH**..... 29,500
- BOOM HOIST**..... 15,100

- EQUALIZER AND PENDANT LINKS** 1,860
- NOTE: Gantry and backhitch, boom hoist and fully reeved equalizer can be removed as a unit. Total weight: 49,300 pounds.*
- REMOVABLE COUNTERWEIGHT (5-PC)**
- Lower..... 44,000
 - Middle Left and Middle Right (each 20,500).... 41,000
 - Upper Left and Upper Right (each 17,500).... 35,000
 - Total..... 120,000
- BOOM NO. 27B**
- BOOM BUTT:** (less wire rope and pendants).. 11,670
 - BOOM TOP:** (equipped with lower boom point and sheaves)..... 11,060
 - Add for upper boom point and sheave . 1,140
 - Total..... 12,200
- BOOM INSERTS:**
- Insert—10' (with pendants)..... 2,500
 - Insert—20' (with pendants & wire rope guide) . 4,225
 - Insert—40' (with pendants & wire rope guides) 7,050

*Weights are approximate and may vary between machines as a result of design changes and component variations.

POWER PLANTS		Cylinder	Bore	Stroke	Cubic Inch Displacement	Net HP @ RPM (at flywheel)
BASIC	Cummins VTA-1710-C700 Diesel	12	5.50"	6.0"	1,710	685 @ 2,000*
OPTIONAL	Caterpillar D-379-B Diesel	8	6.25"	8.0"	1,964	635 @ 1,270*

* Ratings Without Fan. Fuel Tank Capacity: 840 Gallons.

LOWER MACHINERY

CARBODY: One-piece, ribbed steel fabrication with integral side wings. Side wings transmit loads directly to crawler side frames, eliminating axles and providing lower center of gravity.

RING GEAR AND ROLLER PATH: Cast alloy steel. Integral ring gear and roller path bolted to carbody. Internal gear teeth, machine cut. Roller path has 134" outside diameter with 5" thick hook roller flange.

KING PIN: Cast steel. Bolted to carbody with high strength bolts. Provides pivot for rotating upperworks. Takes horizontal load only, no uplift. Pressure-lubricated bronze bearing in rotating bed.

TRAVEL SHAFTS: Power transmitted through vertical travel shaft to three-piece horizontal travel shaft by bevel gears enclosed in oil bath. Final reduction gears at end of each travel shaft increases torque to crawler drive sprockets. Reduction gears, steering and travel mechanism enclosed in carbody by protective steel covers.

TRAVEL AND STEERING: Air controlled jaw clutches normally engaged for straight travel. For gradual or sharp turns, clutch may be positioned in neutral or locked position respectively. Interlock keeps one jaw clutch engaged at all times.

TRAVEL LOCKS: Air operated travel locks have dual ratchet and pawl permitting travel in one direction while preventing movement in opposite direction. Can be set to prevent travel in either direction. Travel lock pawls engage external teeth on travel jaw clutch. Each pawl can be released separately by independent air control.

CRAWLER SIDE FRAMES: Steel fabrication with integral supports for attachment to carbody. Twelve, 20" diameter double-flanged cast steel intermediate idler rollers are mounted between side plates on 6" diameter stationary shafts. Each roller supported by dual bronze bearings with center grease pocket. Abrasion resistant slide bars on top of frames support crawler pads.

CRAWLER FRONT IDLER: Double-flanged cast steel roller; large bronze bearing on each end and grease pocket in center. Mounted on 7" diameter stationary shaft supported at both ends in side frame. Tread belt adjusted by hydraulic jack and U-shaped shims which hold shaft in position.

CRAWLER SPROCKET AND TUMBLER: Cast steel. Teeth and tumbler rim flame-hardened. Driving torque transmitted through single-unit integral sprocket and tumbler with bronze bearings on each end and center grease pocket. Mounted on 7" diameter stationary shaft supported at both ends in side frame. Self-cleaning tumbler has alternate sides open. Drive chain adjustment accomplished by moving tumbler with hydraulic jack. U-shaped shims hold tumbler shaft in position.

CRAWLER DRIVE: Drive chains located outside of crawler frame. Drive sprockets self-contained within crawler side frames are joined to horizontal travel shaft by jaw clutch coupling. Allows crawler removal without separating drive chains or tread belts.

CRAWLER PADS: Cast alloy steel. Box section design with central driving lug, internally ribbed for extra strength. Bottom edges tapered upward. Each pad connected by two high carbon, wear resistant steel pins.

UPPER MACHINERY

ROTATING BED: One-piece, ribbed steel fabrication with integral machinery side frames forms a rigid deck for power plant, house rollers, rotating machinery, gantry support and boom hinge.

HOUSE ROLLERS: 6 antifriction bearing mounted; 4 Front, 2 Rear.

HOKK ROLLERS: 6 antifriction bearing mounted on eccentric shafts for adjustment; 2 Front, 4 Rear.

UPPER STRUCTURE: Fabricated steel rear column, roof support and center support structure. Fabricated steel front leg supports with integral box section cross brace. Structure supports gantry, counterweight and boom hoist assembly.

POWER PLANTS: See bottom of page 2.

POWER TRANSMISSION, VICON[®]: The VICON (Variable Independent CONtrol—Patented) system provides stepless variable control power transmission for various machine functions. Engine power divided at transmission case to hoist converter, two swing converters, and hydraulic pumps which power boom hoist and travel functions.

HOIST DRIVE: Controlled torque converter chain drives a sprocket floating independently on antifriction bearing mounted main drive shaft. Pinion bolted to this sprocket engages a reduction gear splined to antifriction bearing mounted countershaft. Another pinion splined to countershaft, engages a gear on rear drum shaft which drives a similar gear on the front drum shaft. Chain and gear drives are enclosed and oil lubricated.

SWING DRIVE: Two controlled torque converters driven at constant input speed from transmission case. Converter outputs connected through gear drive so that one converter powers swing in left direction and other converter powers swing in right direction. Converters provide stepless, variable power to swing in either direction and eliminates need for reversing clutches. Swing output transmitted to main drive shaft by chain drive. Chain and gear drives are enclosed and oil lubricated.

TRAVEL DRIVE: Powered through variable displacement hydraulic pump mounted directly to transmission case.

BOOM HOIST DRIVE: Powered through variable displacement hydraulic pump mounted directly to transmission case.

MAIN DRIVE SHAFT: Alloy steel, mounted on antifriction bearings. Power from swing drive transmitted by chain drive to outboard sprocket on main drive shaft. This sprocket is mounted to an adapter which is splined to main drive shaft and powers swing bevel gear. The chain and gear drives are enclosed and oil lubricated.

SWING MACHINERY: Vertical swing shaft is alloy steel, mounted on antifriction bearings with bevel gear splined to upper end. Receives power from bevel gear on main drive shaft. Pinion on lower end of vertical swing shaft drives double gear reduction to main swing pinion which meshes with ring gear.

UPPER MACHINERY (continued)

TRAVEL MACHINERY: Dual, reversible hydraulic motors drive through gear case, horizontal shaft, bevel gear set and gear reduction to vertical travel shaft. Pressure compensating hydraulic system varies torque and speed output of motors to suit travel requirements.

COUNTERSHAFT: Countershaft gear and drum drive pinion are splined to left end of countershaft and straddle large antifriction bearing. Gears enclosed and run in oil-tight case.

FRONT AND REAR DRUM ASSEMBLIES: Both drums have heat-treated alloy steel drum shafts with antifriction bearing mountings. Integral drum gear hubs and clutch spiders are keyed to drum shafts. Steel drums mounted on antifriction bearings have bolted cast iron combination brake and clutch flanges on left side, brake flange only on right side. Air controlled, internal expanding band-type drum clutches are mounted on left side and have heavy duty molded linings. Dual, air actuated, external contracting band-type brakes are spring set for parking and automatically set in the event of air pressure loss. Rear drum is used for main load line on liftcrane and front drum is used for whipline.

INDEPENDENT BOOM HOIST: Dual drums, alloy steel drum shaft. Driven by alloy steel worm shaft and bronze worm gear through gear and pinion reduction. Gears fully enclosed and run in oil. All rotating shafts antifriction bearing mounted. Boom hoist powered independently by vari-

able displacement hydraulic motor providing full range speed control. Boom hoist brake is external contracting band-type, spring applied, air released, located on worm shaft; automatically releases or sets as boom hoist is engaged or disengaged. Auxiliary brake, external contracting band-type, set from operator's station. Ratchet on boom hoist drum flange with pawl mounted on gear housing. Boom hoist mounted at back of machine on rear column.

GANTRY AND BACKHITCH: Gantry is fabricated plate with parallel box section legs. Mounted to fabricated support, pin-connected to rotating bed and center support structure. Backhitch is two-piece telescoping, link-type construction, with power actuated link pins. Gantry and backhitch are pin-connected. Vertical lower gantry sheaves antifriction bearing mounted; horizontal equalizing sheaves and floating vertical upper gantry sheaves bronze bearing mounted.

GANTRY LIFTING DEVICE: Electrically controlled hydraulic unit used for partially raising gantry prior to erection into working position. Also controls lowering of gantry onto cab roof.

AUTOMATIC BOOM STOP: Push rod contacts electric switch which actuates valve in air line automatically stopping air supply to independent boom hoist hydraulic pump positioner. Set to stop hoisting when boom reaches maximum angle.

TELESCOPIC BOOM STOP: Telescoping tubes, air cushioned. Pinned to boom and A-frame. Starts cushioning at $76\frac{1}{2}^\circ$ with positive physical stop at 85° from horizontal.

POWER TRAIN

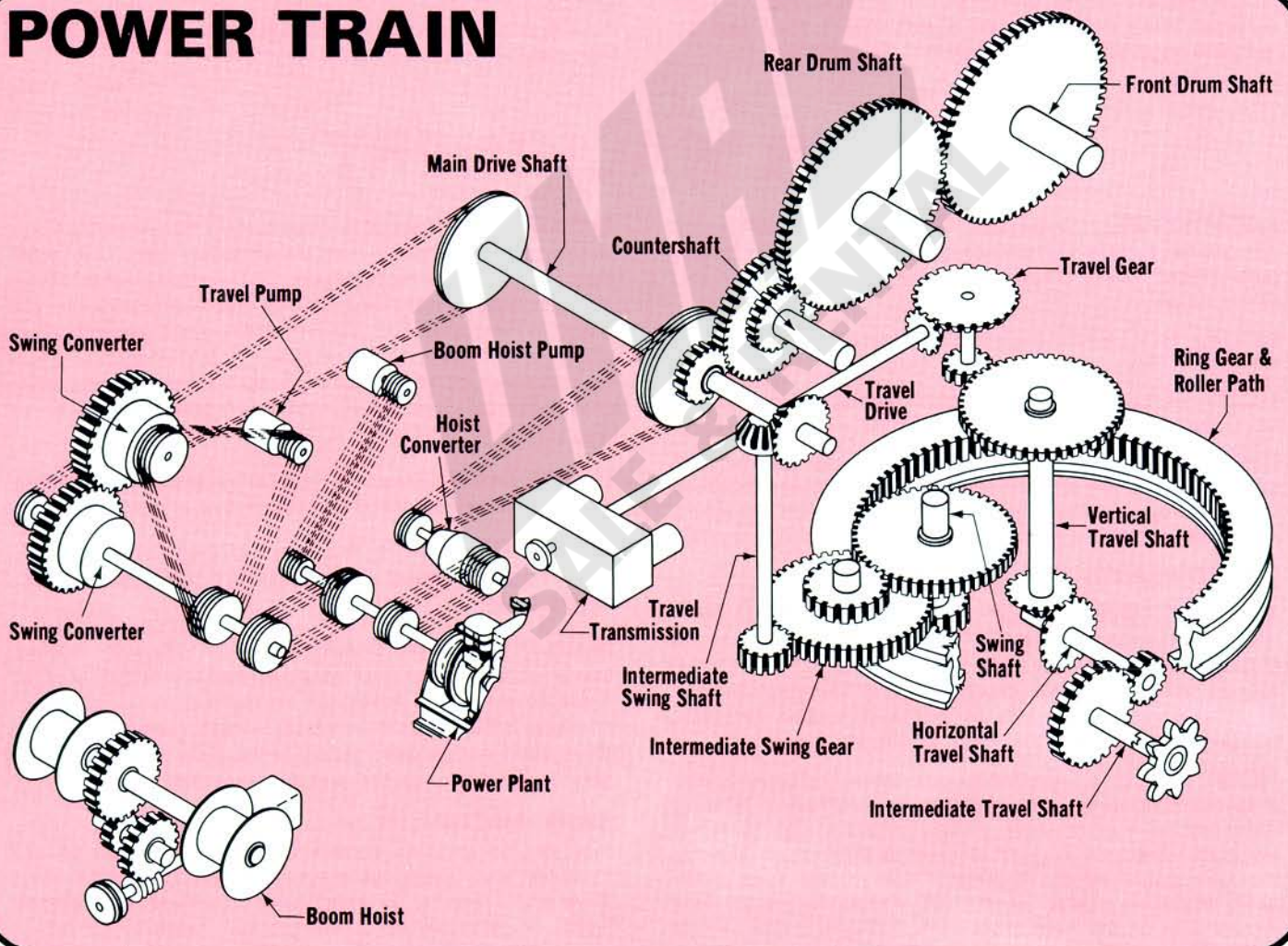

DRUMS & LAGGINGS

TANDEM DRUM SHAFT							
Application	Drum	Diameter	Drum Width	Type of Lagging	Wire Rope Size	Spooling Capacity	
						Layers	Maximum Capacity Without Ratchet
LIFTCRANE Hoist Whip Optional	Rear	28"	43¼"	None	1¼"	9	2,900'
	Front	28"	43¼"	None	1¼"	9	2,900'
	Front	41½"	43¼"	Plain	1¼"	3	1,115'
CLAMSHELL Closing Holding	Rear	41"	43¼"	Grooved	1½"	First Layer Only	289'
	Front	41"	43¼"	Grooved	1½"		289'

FRONT END EQUIPMENT

NO. 27B BOOM: 80' boom (40' heavy duty butt section and 40' open throat top section); optional 10', 20' and 40' inserts. All welded construction. Inverted angle chords 100,000 PSI yield steel. Butt, top and inserts 114" wide x 90" deep at pin-connected joints. Each insert matched with two pair of 1½" diameter single-length pendants. Lower boom point equipped with eight 32" diameter sheaves, antifriction bearing mounted. Maximum boom length 310'.

BOOM RIGGING: Twelve-part line, reeved between gantry and equalizer. Controls boom angle by dual lines from independent boom hoist drums. Two pair of 1½" diameter pendants connect equalizer to boom point. For longer booms, pendants matched to insert lengths.

EQUALIZER: Steel fabrication. Six vertical sheaves, antifriction bearing mounted.

WIRE ROPE GUIDE: Mounted on top side of boom. Two sets of interlocking fleeting sheaves. One set for main hoist line and one set for whipline. Bronze bearing mounted.

WIRE ROPE ROLLER GUIDE: Mounted on top side of boom. Induction hardened. Antifriction bearing mounted.

UPPER BOOM POINT: Optional detachable assemblies. Pin-connected to open throat top. Single 36" OD sheave with rope guard for liftcrane. Double 47" OD sheaves with cheek plates for clamshell. All sheaves antifriction bearing mounted.

4½° OFFSET BOOM TOP: Optional. Permits greater clearance between load and boom. Standard No. 27B boom converted by adapter links at upper boom joint. Basic length 80'; maximum length 310'.

FOR CAPACITY CHARTS AND INFORMATION, CONSULT FACTORY.

NO. 125 JIB: Optional. 44-ton maximum capacity, 40' length, extendible to 80' with 10' and 20' inserts and matching pendants. Jib offset angle adjustable to 3, 10, and 20 degrees. All welded construction. Tubular chord and lacing members; 48¾" wide x 38¼" deep at pin-connected joints. Top section has 32" OD antifriction bearing sheave, cheek plates and anchor joint for two-part line.

CONSULT JIB LIFTING CAPACITY CHARTS FOR SPECIFIC CAPACITY WHEN USED ON VARIOUS BOOM LENGTHS.

GENERAL

FIXED OPERATOR'S MODULE: Standard. Fully enclosed and insulated steel module with large safety glass windows. Independently mounted to right front of machinery house on fixed brackets. Isolated from machinery noise. Cab swings forward of rotating bed for 11' 1½" shipping clearance. Air signal horn, air windshield wipers, air circulating fan and 24 volt dome light are standard. Heater and air conditioner optional.

MOVABLE OPERATOR'S MODULE: Optional. Same operator's module as above, but with power actuated bracket arrangement which permits raising, lowering or extending the module as shown on outline dimensions.

CONTROLS: Graduated air controls for main functions. VICON® system on front and rear drums. Drum control levers are combination clutch and converter control; first

movement engages drum clutch; further movement increases converter output torque permitting variable speed. Air operated treadle type drum brakes for feel and ease of operation with spring set, air released parking brake. With VICON® system on swing, movement of control lever increases converter output in direction of desired swing permitting variable speed. Air actuated, hydraulic valves operate boom hoist and travel functions. Drum rotation indicators are standard for boom hoist and front and rear drums. Control side consoles provide for good downward visibility.

SWING SPEED: Variable, 2.4 RPM maximum.

TRAVEL SPEED: Variable, 1.0 MPH maximum.

GRADEABILITY: 30%.

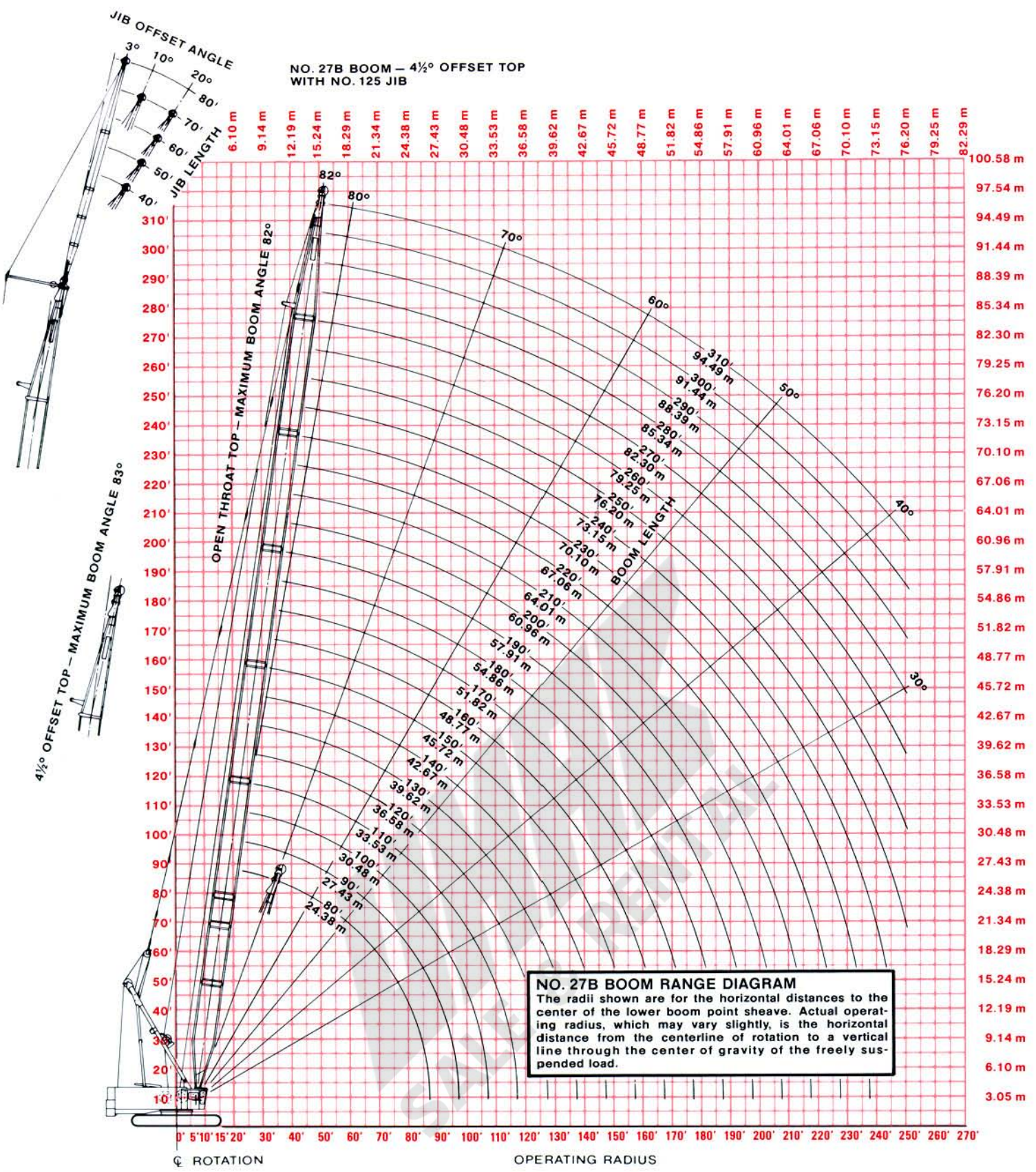

Larger-scale blueprint-type RANGE DIAGRAMS for planning your lifts are available from factory.

Because of a program of continuing improvements, Manitowoc Engineering Co. reserves the right to change this description at any time, without notice.



MANITOWOC ENGINEERING CO.
(A division of The Manitowoc Company, Inc.)
Manitowoc, Wisconsin 54220

RADIUS		CAPACITIES IN THOUSANDS OF KILOGRAMS (METRIC TONS)													RADIUS	
		BOOM LENGTH														
FT.	M.	140	180	200	220	240	260	280	300	320	340	360	380	400	FT.	M.
		55	16.8	680.3*												
60	18.3	680.3*													18.3	60
65	19.8	680.3*													19.8	65
70	21.3	680.3*													21.3	70
75	22.9	604.7*													22.9	75
80	24.4	543.7													24.4	80
85	25.9	492.0*													25.9	85
90	27.4	445.5*													27.4	90
95	29.0	406.0*													29.0	95
100	30.5	372.0*													30.5	100
105	32.0	341.6*													32.0	105
110	33.5	314.4*													33.5	110
115	35.1	290.2*													35.1	115
120	36.6	268.7*													36.6	120
125	38.1	249.3*													38.1	125
130	39.6	231.7*													39.6	130
135	41.1	215.5*													41.1	135
140	42.7	200.6*													42.7	140
145	44.2	186.6*													44.2	145
150	45.7	173.5*													45.7	150
155	47.2	160.7*													47.2	155
160	48.8	148.0*													48.8	160
165	50.3	133.4*													50.3	165
170	51.8	117.3*													51.8	170
175	53.3	101.2*													53.3	175
180	54.9	85.1*													54.9	180
185	56.4	69.0*													56.4	185
190	57.9	52.9*													57.9	190
195	59.4	36.8*													59.4	195
200	61.0	20.7*													61.0	200
205	62.5	4.6*													62.5	205
210	64.0														64.0	210
215	65.5														65.5	215
220	67.1														67.1	220
225	68.6														68.6	225
230	70.1														70.1	230
235	71.6														71.6	235
240	73.2														73.2	240
245	74.7														74.7	245
250	76.2														76.2	250
255	77.7														77.7	255
260	79.2														79.2	260
265	80.8														80.8	265
270	82.3														82.3	270
275	83.8														83.8	275
280	85.3														85.3	280
285	86.9														86.9	285
290	88.4														88.4	290
295	89.9														89.9	295
300	91.4														91.4	300
305	93.0														93.0	305
310	94.5														94.5	310
315	96.0														96.0	315
320	97.5														97.5	320
325	99.1														99.1	325
330	100.6														100.6	330
335	102.1														102.1	335
340	103.6														103.6	340
345	105.2														105.2	345
350	106.7														106.7	350
355	108.2														108.2	355

DJK
REV. 9/6/83
DRWG. #7300-AH SHEET 1 OF 2

MANITOWOC ENGINEERING CO.
MANITOWOC, WISCONSIN

MANITOWOC 4600 SERIES 4 - RINGER SERIES 3
LIFTCRANE CAPACITIES - 18.3M (60 FT.) RINGER ATTACHMENT
ON BLOCKING OR PEDESTALS
BOOM #65
55,790KG (123,000#) CRANE AND 443,930KG (978,700#) AUXILIARY CWT.

MEETS ANSI B30.5 REQUIREMENTS

CAPACITIES FOR VARIOUS BOOM LENGTHS AND OPERATING RADII ARE FOR FREELY SUSPENDED LOADS AND DO NOT EXCEED 75% OF A STATIC TIPPING LOAD. CAPACITIES BASED ON STRUCTURAL COMPETENCE ARE DENOTED BY AN ASTERISK (*).

MAXIMUM BOOM AND JIB LENGTHS LIFTED UNASSISTED		DEDUCT FROM CAPACITIES WHEN JIB IS ATTACHED	
BM. LGTH.	JIB #27AB	JIB LGTH.	JIB #27AB
121.9M	---	24.4M	21,770KG
115.8M	36.6M	30.5M	26,220KG
		36.6M	30,390KG

LOAD BLOCK, HOOK & WEIGHT BALL ON GROUND AT START.

UPPER BOOM POINT CAPACITIES FOR SINGLE PART WHIP LINE ARE 19,950KG (44,000#) FOR 31.8MM (1-1/4 IN.) WIRE ROPE, 20,410KG (45,000#) FOR 34.9MM (1-3/8 IN.) WIRE ROPE AND 22,670KG (50,000#) FOR 38.1MM (1-1/2 IN.) OR 41.3MM (1-5/8 IN.) WIRE ROPE. CAPACITIES FOR TWO PART LINE ARE 39,910KG (88,000#) FOR 31.8MM (1-1/4 IN.) WIRE ROPE, 40,820KG (90,000#) FOR 34.9MM (1-3/8 IN.) WIRE ROPE AND 45,350KG (100,000#) FOR 38.1MM (1-1/2 IN.) OR 41.3MM (1-5/8 IN.) WIRE ROPE. IN ALL CASES, UPPER BOOM POINT CAPACITIES CANNOT EXCEED THOSE LISTED FOR THE MAIN BOOM CAPACITY.

WEIGHT OF JIB, ALL LOAD BLOCKS, HOOKS, WEIGHT BALL, SLINGS, HOIST LINES, ETC., BENEATH BOOM AND JIB POINT SHEAVES, IS CONSIDERED PART OF THE MAIN BOOM LOAD. BOOM IS NOT TO BE LOWERED BEYOND RADII WHERE COMBINED WEIGHTS ARE GREATER THAN RATED CAPACITY. WHERE NO CAPACITY IS SHOWN, OPERATION IS NOT INTENDED OR APPROVED.

MACHINE TO OPERATE ON A FIRM SURFACE WITH ROLLER PATH LEVEL WITHIN A TOLERANCE OF 31.8MM (1-1/4 IN.) IN 18.3M (60 FT.) AND PROPERLY SUPPORTED. REFER TO RIGGING #66184, LOAD LINE SPECIFICATION CHART #7307-A OR #7357-A AND RANGE CHART #7305-A. CRANE OPERATOR JUDGMENT MUST BE USED TO ALLOW FOR DYNAMIC LOAD EFFECTS OF SWINGING, HOISTING OR LOWERING, WIND CONDITIONS, AS WELL AS ADVERSE OPERATING CONDITIONS AND PHYSICAL MACHINE DEPRECIATION.

OPERATING RADIUS IS THE HORIZONTAL DISTANCE FROM THE AXIS OF ROTATION TO THE CENTER OF VERTICAL HOIST LINE OR LOAD BLOCK.

MACHINE EQUIPPED WITH 18.3M (60') RINGER ATTACHMENT, 9.3M (30'-5) CRAWLERS, 1.5M (60 IN.) TREADS, 10.1M (33') RETRACTABLE GANTRY, 39.6M (130') MAST, 18 PART BOOM HOIST REEVING, EIGHT 34.9MM (1-3/8 IN.) BOOM PENDANTS, 55,790KG (123,000#) CRANE CWT. (54,430KG (120,000#) WITH CWT. ASSEMBLY #49667) AND 443,930KG (978,700#) AUXILIARY CWT.

DJK
REV. 9/6/83
DRWG. #7300-AH SHEET 2 OF 2

MANITOWOC ENGINEERING CO.
MANITOWOC, WISCONSIN