



model 31000

PROVISIONAL



product
guide

23 May 2008

features

- 2 300 mton (2,535 t) main boom
- 1 400 mton (1,540 t) vessel jib
- 1 000 mton (1,100 t) luffing jib
- 32 000 mton-m (241,456 ft-kips) Maximum Load Moment
- 105 m (344.5 ft) Heavy-Lift Boom
- 102 m (339 ft) Luffing Jib on Heavy-Lift Boom
- 24 m (79.8 ft) Vessel Jib on Heavy-Lift Boom
- 894 kW (1,200 HP) twin engine
- Variable Position Counterweight (VPC) - Patent Pending
- EPIC® controls with CAN-Bus technology
- 139 m/min (456 fpm) line speed standard
- 490 kN (110,000 lb) line pull standard
- Designed to meet US weight and European width requirements
- Fast, efficient self-assembly and disassembly

contents

Specifications

3

Outline Dimensions

6

Boom Combinations

14

Boom Asset Management

16

Crane Assembly

18

Range Diagrams/Load Charts

22

Manitowoc Crane Care

24



UMAX
SALE & RENTAL

Upperworks



Engine

Two Cummins QSX 15, in-line six cylinder diesel engines, 447 kw (600 hp.) each at 1800 rpm, U.S. EPA Tier 3 and E.U. Stage IIIA emissions compliant.

Two independent main drive engines, hydraulics, operator's cab, electrical and electronics to be integrated into an easily transportable and rigged package. FACT is used to install the power module on the left side of the rotating bed.

A four pad pump drive transmission with an automotive style cold start disconnect clutch is bolted to the engine flywheel housing of each engine.

A diesel fuel tank with a 2,270 l (600 gal) draw capacity mounted in the power module container; level indicator provided in the operator's cab.

A 220 volt, 50/60 hertz, single phase, hydraulically driven AC alternator for air conditioning, heating, lighting and multiple uses on the jobsite.

A 220 volt, 50/60 hertz, single phase diesel engine driven stand by AC alternator is provided.

Optional: A fire suppression system in the engine area of the power module is optional.



Controls

Modulating electronic over hydraulic controls provide infinite speed response directly proportional to the operator's control lever movement. Controls include Manitowoc's exclusive EPIC Electronically Processed Independent Control system with CANBus technology system providing microprocessor driven control logic, variable displacement pump and motor control, on-board diagnostics, and service information.

Block up limit control is provided for all load hoist and whip lines.

An integrated Rated Capacity Indicator (RCI) is provided for main boom. The RCI for the upper point, luffing and fixed jib, and optional main boom configurations is provided with these optional configurations. Function-cut out or warning only operation is available via programmable configuration.

Travel and swing alarms are provided.



Hydraulic System

3

High-pressure variable displacement piston pumps, driven by two multi-pump transmissions, provide independent closed-loop hydraulic power for hoisting drums, mast hoist, boom hoist, swing and crawlers.

A gear pump provides power for jacks, powered pin actuation, and other accessories.

Hydraulic reservoir capacity is 2,270 l (600 gal) and is equipped with breather, site and electrical level indicator, clean out access, and internal diffuser.

Each function is equipped with relief valves to protect the circuit from overload or shock.

Replaceable, ten micron (absolute) full flow tank filters are installed. All hydraulic fluid is filtered prior to returning to the reservoir.

The hydraulic system includes a hydraulic fluid heat exchanger designed for high ambient temperature operation



Drums

Two independent equal width drums are each driven through two planetary reduction boxes with two variable displacement axial piston hydraulic motors. Each motor input has an internal spring applied, hydraulically released wet multi-disc brake.

The drums are grooved for 50 mm rope with spooling capacity of 1400 meters (4600 ft.)

Optional: Third hoist load drum mounted in the rotating bed. This drum is by driven through two planetary reduction boxes with two variable displacement axial piston hydraulic motors. A spring-applied, hydraulically released wet multi-disc brake is provided at each motor input. It is grooved for 50 mm rope.



Boom Hoist System

An independent boom hoist with two drums on a common barrel is mounted in the rotating bed. Drums are grooved for 36 mm rope with reeving of 28 parts of boom hoist line.

The barrel is driven through two planetary reduction boxes with two variable displacement axial piston hydraulic motors. Each motor input has an internal spring applied, hydraulically released wet multi-disc brake.

specifications

4 Swing System

Each independent swing drive is powered by fixed displacement axial piston hydraulic motors coupled to a planetary gearbox with an internal spring-applied wet multi-disc brake. The front and rear roller carriers have four swing drives each.

Swing system maximum speed: 0.50 rpm.



Variable Position Counterweight

Variable Position Counterweight (VPC) - Patent Pending: Load moment balancing counterweight infinitely variable between a retracted position of 8.38 m (27' 6") and an extended position of 28.93 m (94' 11"). Counterweight automatically positioned based on the boom angle and applied load.

949 m-ton (2,092,700 lb) of variable position counterweight consisting of a tray and "A" frames plus 44 twenty m-ton (44,000 lb) counterweight pieces.

No carbody counterweights.



Operator's Cab

The operator's seat and related crane controls tilt up to 20°.

Closed circuit cameras, one to monitor each rope drum, and camera to monitor the variable position counterweight. Three monitors with divisible screens provided.

Insulated for noise and weather.

Lowerworks



Carbody

The carbody consists of front and rear cross beams plus two side beams. A cross beam at the center provides support for the king pin and hydraulic swivel.

Carbody beams are FACT™ connected, all pins are hydraulically inserted.

Four hydraulic jacking cylinders assist assembly.

All beams are bending and torsion resistant welded structure fabricated from high strength, fine grained steel.

Roller Path and Ring Gear

The roller path is 12.19 m (40') outside diameter, integral with the carbody beams. The roller path is precision machined after welding.

Precision cut ring gear segments are bolted to the inside diameter of the roller path.



Crawlers

Individual trunion mounted crawler assemblies pivotally attach to each end of the front and rear cross beams. This design assures uniform load distribution over the length of each assembly.

The four crawler assemblies are hydraulically powered, the two right-side assemblies operating in unison and the two left-side assemblies operating in unison. Dual drives are installed on each crawler assembly.

The overall length of each crawler assembly is 8.62 m (28' 3"). The track pads are 2.03 m (80") wide.

Crawler drives enable travel and counter-rotation with full rated load. Maximum travel speed is 0.55 km/h (0.34 mph)

Attachments



No. 90 Heavy-Lift Boom

The liftcrane is equipped with 55 m (179' 5") No. 90 basic boom consisting of 7 m (22' 10") butt, (4) 10 m (32' 9") inserts, 6.5 m (21' 4") transition insert and 1.5 m (4' 11") top. Includes rope guides, boom hoist wire rope and boom angle indicators. The boom connectors utilize Manitowoc's exclusive FACT™ connection system boom connector. Spring cushioned boom stop. Automatic boom stop. Powered boom pins system including cylinder, piping, operating controls, and locking device standard.



Fixed Jib (Vessel Lifting)

➤ Optional: Fixed Jib (vessel lifting) 24 m (78' 8")

7 m (22' 11") butt, 9 m (29' 6") insert, 6.5 m (21' 4") transition insert and 1.5 m (4' 11") top.

Steel Jib suspension straps and FACT™ connection system.



No. 91 Luffing Jib

- Optional: 36 m (118') basic No. 91 luffing jib 7 m (22' 11") boom butt; 9 m (29' 6") insert; 12 m (39' 3") insert; 6.5 m (21' 4") transition insert and 1.5 m (4' 11") top; basic pendants, fixed strut, jib strut, backstay suspension straps, luffing jib hoist with ratchet and pawl and boom dolly; quick disconnect for jib hoist piping, and 38 mm luffing jib hoist line (luffing jib preparation is standard).
- Optional: 6 m (19' 8") and 12 m (39' 5") No. 91 luffing jib inserts with steel boom suspension straps and FACT™ connection system.

Optional Equipment

- Optional: Segmented Hook Block:
The segmented, mechanically equalized, divisible hook block consists of two 1,000 m-ton capacity duplex hooks with configurations as follows:

2000 m-ton, two hooks, two load hoist drums
1000 m-ton, one hook, two load hoist drums
500 m-ton, one hook, one load hoist drum

Miscellaneous

Bearing Loads Under Track Shoes

Bearing with boom straight over the end:

No hook load: 9,200 MPa (63 psi, 9,060 lbs/ft²).

At maximum load moment: 15,800 MPa (109 psi, 15,700 lbs/ft²)

Bearing with boom swing 45° from crawler longitudinal center at maximum load moment: 17,500 MPa (121 psi, 17,300 lbs/ft²)

outline dimensions

CONFIDENTIAL

6

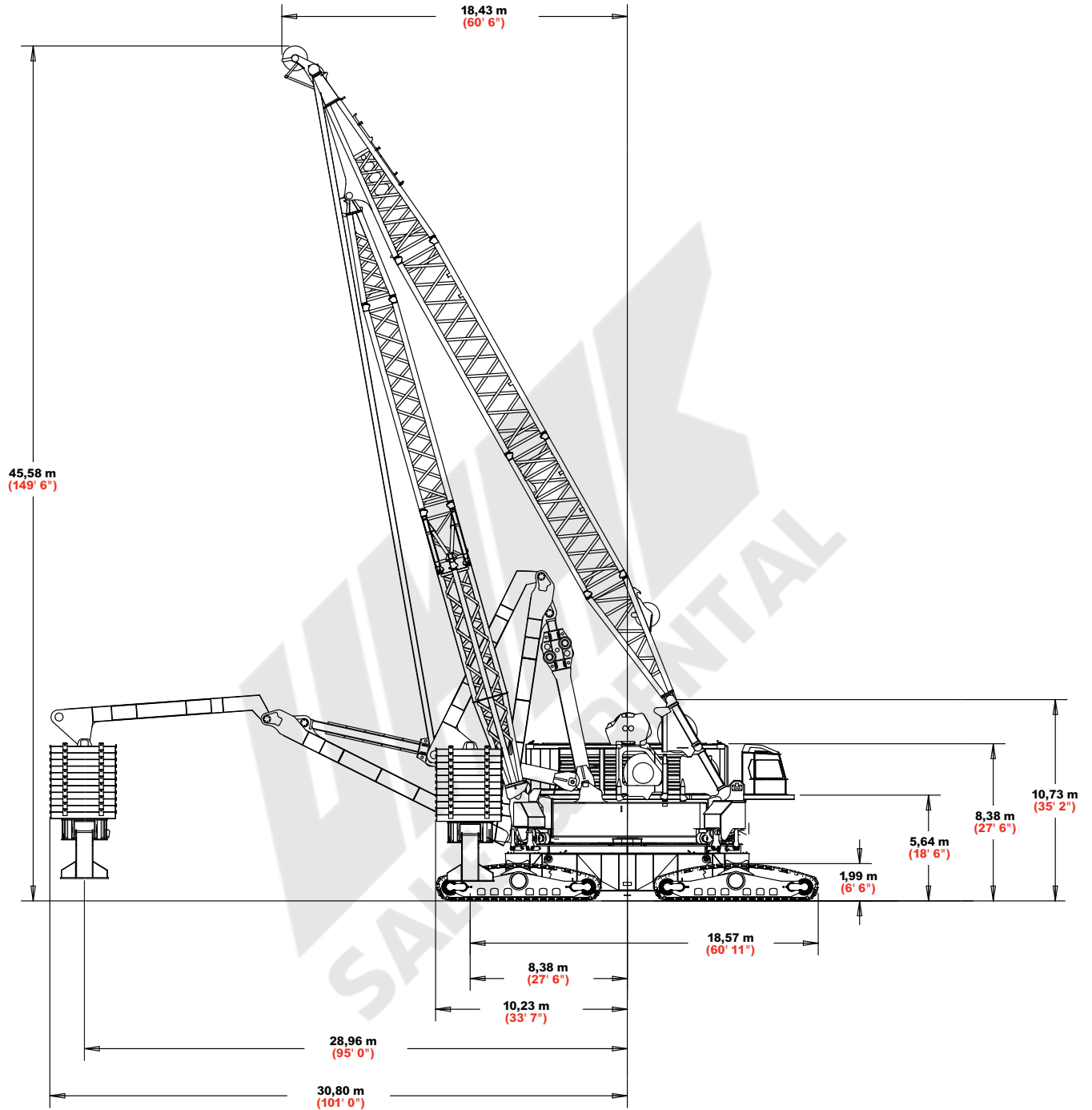

model 31000
Manitowoc

PROVISIONAL

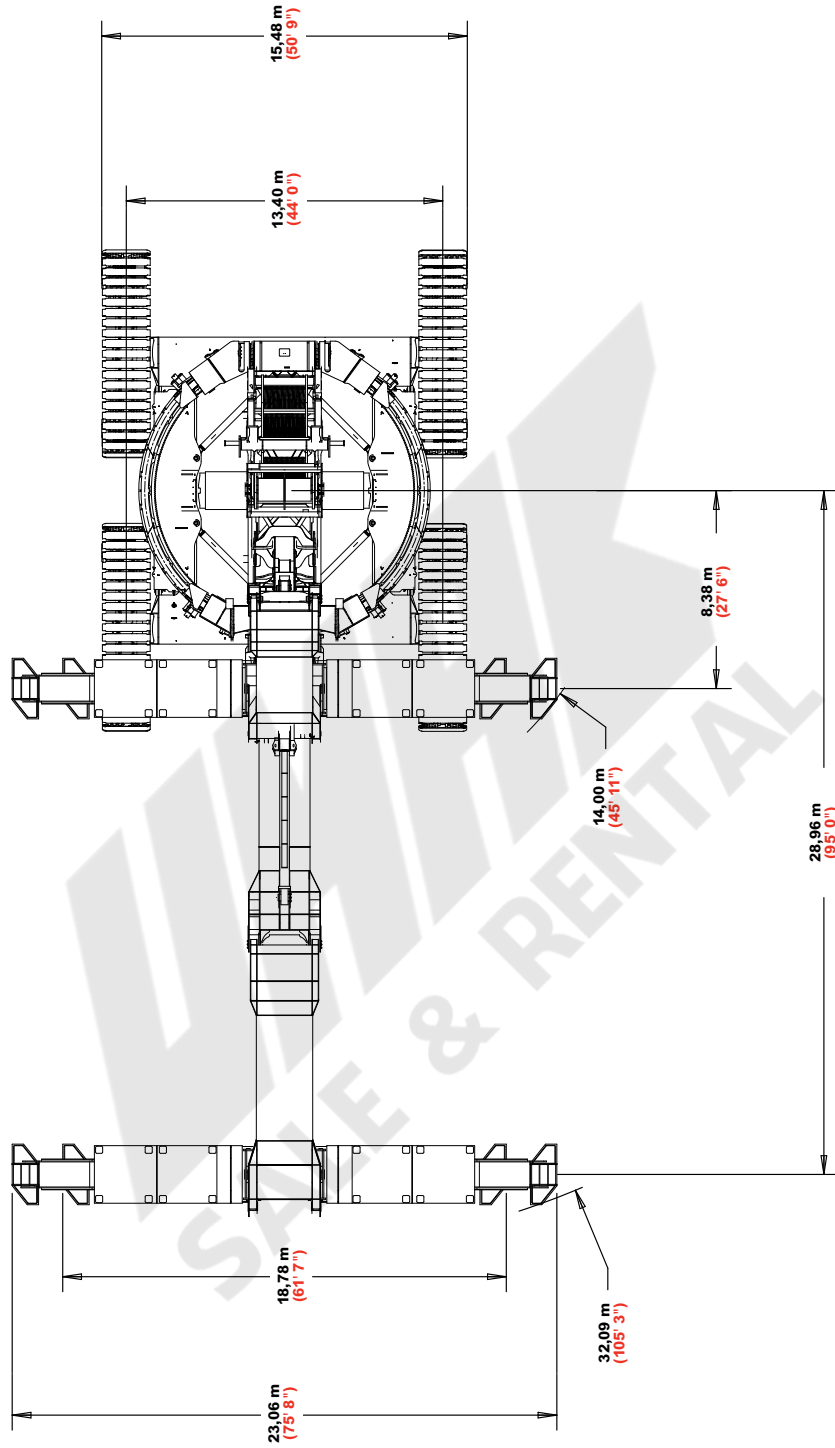

PROVISIONAL

outline dimensions

8

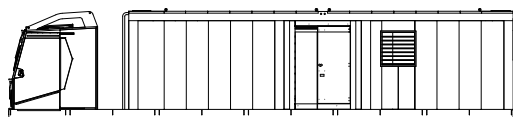

Power Plant and Cab Assembly x 1

Length	15,90 m	52' 2"
Width	3,40 m	11' 2"
Height	3,00 m	9' 10"
Weight	34 610 kg	76,300 lb

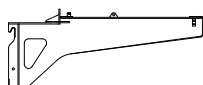

Power Plant Support x 2

Length	4,60 m	15' 1"
Width	1,90 m	6' 3"
Height	0,50 m	1' 8"
Weight	3 600 kg	7,920 lb

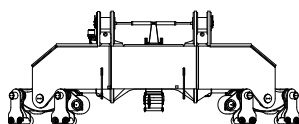

Front Roller Carrier & Hook Roller Assembly x 1

Length	9,70 m	31' 10"
Width	3,10 m	10' 2"
Height	3,40 m	11' 2"
Weight	44 500 kg	97,900 lb

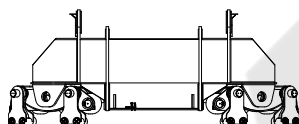

Rear Roller Carrier & Hook Roller Assembly x 1

Length	8,80 m	28' 10"
Width	3,00 m	9' 10"
Height	3,10 m	10' 2"
Weight	39 600 kg	87,120 lb

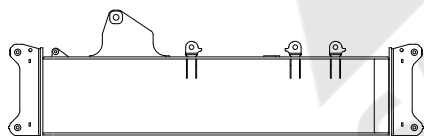

Rotating Bed x 1

Length	9,80 m	32' 2"
Width	3,10 m	10' 2"
Height	3,00 m	9' 10"
Weight	36 500 kg	80,300 lb

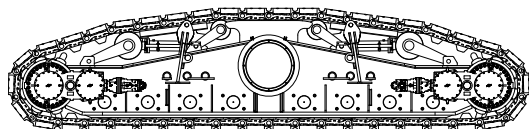

Crawlers x 4

Length	8,70 m	28' 6"
Width	2,60 m	8' 6"
Height	2,30 m	7' 7"
Weight*	49 900 kg	109,780 lb

*Weight without track pad: 28 800 kg (63,360 lb)

Option

PROVISIONAL

outline dimensions

9

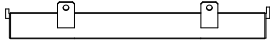

Counterweight x 44

Length	3,50 m	11' 6"
Width	2,50 m	8' 2"
Height	0,60 m	2' 0"
Weight	20 000 kg	44,000 lb

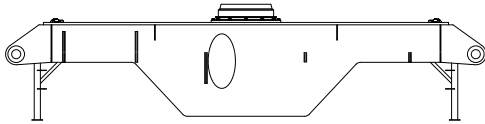

Carbody Center Beam x 1

Length	8,00 m	26' 3"
Width	1,90 m	6' 3"
Height	2,00 m	6' 7"
Weight	8 500 kg	18,700 lb

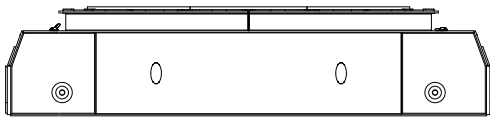

Carbody Beam x 2

Length	11,50 m	37' 9"
Width	2,60 m	8' 6"
Height	2,60 m	8' 6"
Weight	36 600 kg	80,520 lb

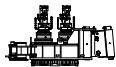

Swing Drive Assembly x 4

Length	2,60 m	8' 6"
Width	1,20 m	3' 11"
Height	1,50 m	4' 11"
Weight	5 200 kg	11,440 lb



Trunion x 4

Length	3,00 m	9' 10"
Width	1,00 m	3' 3"
Height	1,00 m	3' 3"
Weight	5 350 kg	11,770 lb

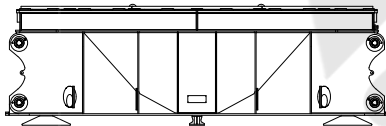

Carbody Side Beam with Struts x 2

Length	9,10 m	29' 10"
Width	2,70 m	8' 10"
Height	2,90 m	9' 6"
Weight	33 100 kg	72,820 lb

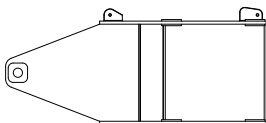

Counterweight Tray Center x 1

Length	5,40 m	17' 9"
Width	3,50 m	11' 6"
Height	2,50 m	8' 2"
Weight	25 300 kg	55,660 lb

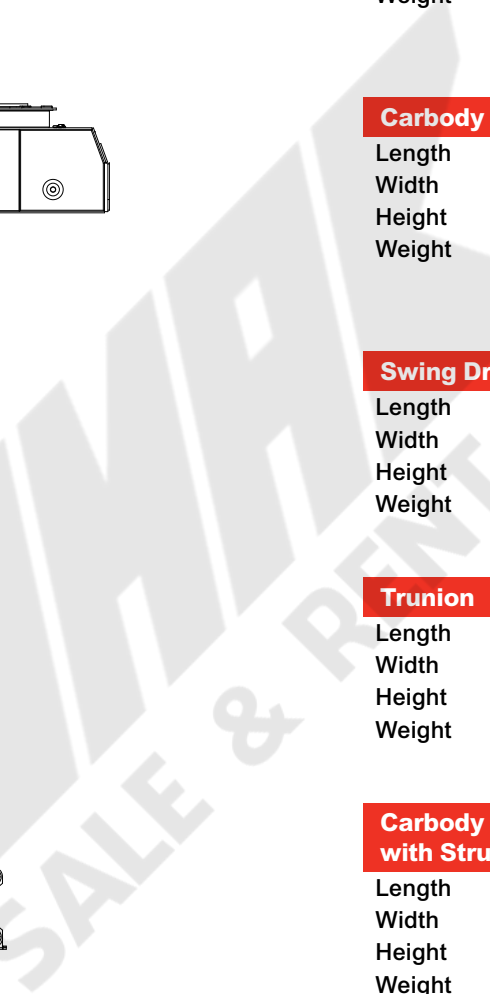

outline dimensions

10

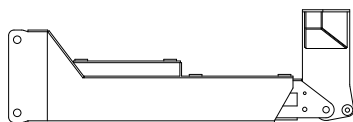

Counterweight Ends with Supports x 2

Length	8,20 m	26' 11"
Width	2,60 m	8' 6"
Height	2,70 m	8' 10"
Weight	37 100 kg	81,620 lb

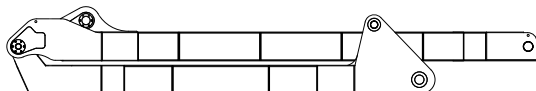

Counterweight Positioning Frame x 1

Length	14,70 m	48' 3"
Width	3,40 m	11' 2"
Height	2,50 m	8' 2"
Weight	38 400 kg	84,480 lb

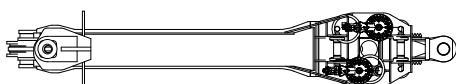

Counterweight Positioning Actuator x 1

Length	10,70 m	35' 1"
Width	2,70 m	8' 10"
Height	1,80 m	5' 11"
Weight	27 200 kg	59,840 lb

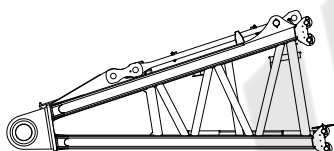

No. 90 Boom Butt 7m x 1

Length	7,90 m	25' 11"
Width	4,00 m	13' 1"
Height	3,20 m	10' 6"
Weight	21 400 kg	47,080 lb

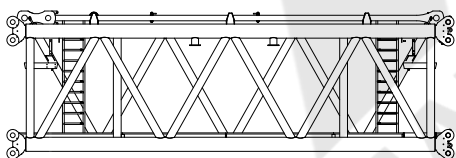

No. 90 10m Boom Insert with Straps x 5

Length	10,30 m	33' 9"
Width	4,00 m	13' 1"
Height	3,2 m	10' 6"
Weight	23 300 kg	51,200 lb

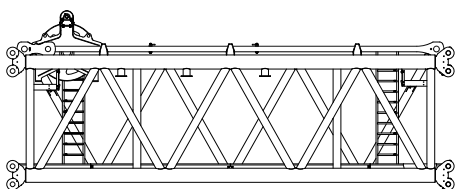

No. 90 Boom Insert with 10m Wire Rope Guide x 1

Length	10,30 m	33' 9"
Width	4,00 m	13' 1"
Height	3,2 m	10' 6"
Weight	24 700 kg	54,340 lb

model 31000



PROVISIONAL

Option

outline dimensions

11

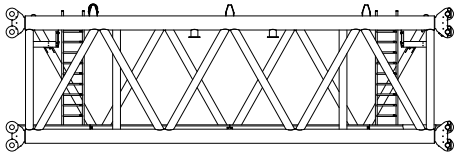

No. 90 10m Boom Insert without Straps x 1

Length	10,30 m	17' 5"
Width	4,00 m	13' 1"
Height	3,20 m	10' 6"
Weight	20 400 kg	44,974 lb

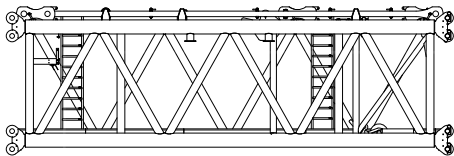

No. 90 Boom Insert Equilizer 10,0m x 1

Length	10,30 m	33' 9"
Width	4,00 m	13' 1"
Height	3,20 m	10' 6"
Weight	26 900 kg	59,525 lb

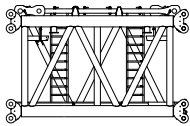

No. 90 5m Boom Insert with Straps x 1

Length	5,30 m	17' 5"
Width	4,00 m	13' 1"
Height	3,20 m	10' 6"
Weight	14 100 kg	31,085 lb

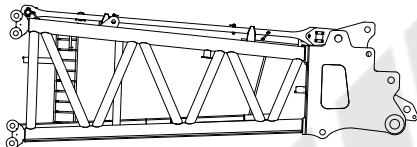

No. 90 Boom Top 8m x 1

Length	9,80 m	32' 2"
Width	4,00 m	13' 1"
Height	3,20 m	10' 6"
Weight	35 100 kg	77,220 lb

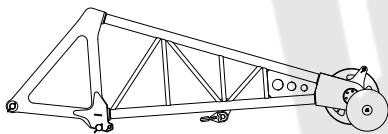

Upper Boom Point Assembly x 1

Length	9,10 m	29' 10"
Width	2,20 m	7' 3"
Height	3,00 m	9' 10"
Weight	7 150 kg	15,730 lb

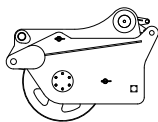

Lower Boom Point Assembly x 2

Length	2,60 m	8' 6"
Width	1,90 m	6' 3"
Height	1,90 m	6' 3"
Weight	10 600 kg	23,369 lb

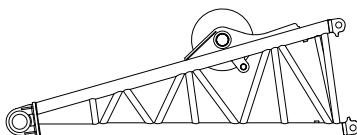

Mast Butt 7.05m x 1

Length	7,60 m	24' 11"
Width	3,10 m	10' 2"
Height	2,80 m	9' 2"
Weight	25 740 kg	25,740 lb

Option

PROVISIONAL

model 31000



outline dimensions

12

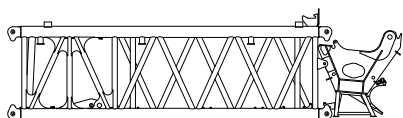

Mast Insert with Raising Frame 8.5m x 1

Length	10,70 m	35' 1"
Width	3,10 m	10' 2"
Height	3,00 m	9' 10"
Weight	25 700 kg	25,740 lb

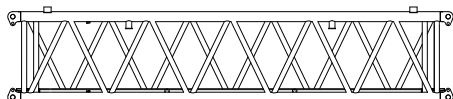

Mast Insert 12m x 1

Length	12,30 m	40' 4"
Width	3,10 m	10' 2"
Height	2,70 m	8' 10"
Weight	9 000 kg	19,800 lb

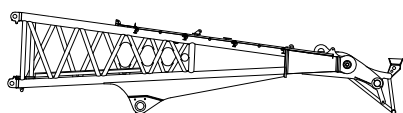

Mast Top 11.05m x 1

Length	13,10 m	43' 0"
Width	3,20 m	10' 6"
Height	3,40 m	11' 2"
Weight	29 600 kg	65,120 lb

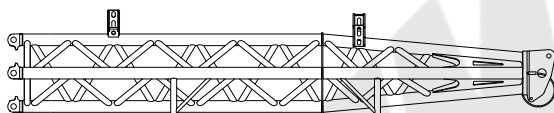

Backhitch Butt 12.5m x 2

Length	13,00 m	42' 8"
Width	2,00 m	6' 7"
Height	1,50 m	4' 11"
Weight	8 100 kg	17,820 lb

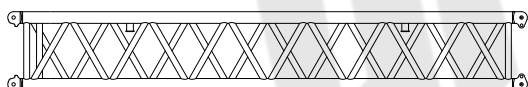

Backhitch Insert 11.4m x 1

Length	12,30 m	40' 4"
Width	2,60 m	8' 6"
Height	1,90 m	6' 3"
Weight	10 500 kg	23,100 lb

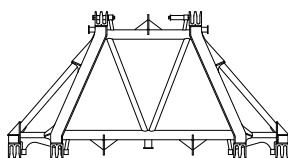

Backhitch Transition Insert 3.2m x 1

Length	6,70 m	22' 0"
Width	1,90 m	6' 3"
Height	3,50 m	11' 6"
Weight	7 600 kg	16,720 lb

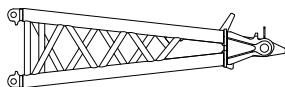

Backhitch Top 5.9m x 1

Length	6,60 m	21' 8"
Width	3,20 m	10' 6"
Height	1,90 m	6' 3"
Weight	6 000 kg	13,200 lb

outline dimensions

13

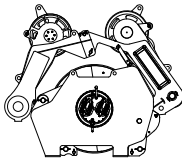

Boom Hoist Drum with Sheave Bank and Equilizer x 1

Length	4,20 m	13' 9"
Width	2,50 m	8' 2"
Height	2,20 m	7' 3"
Weight	40 000 kg	88,000 lb



Whip Line Drum x 1

Length	3,70 m	12' 2"
Width	2,70 m	8' 10"
Height	3,10 m	10' 2"
Weight	26 000 kg	57,200 lb

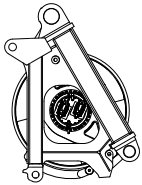

Main Hoist Drum #1 x 1

Length	3,90 m	12' 9"
Width	2,60 m	8' 6"
Height	3,40 m	11' 2"
Weight	35 000 kg	77,000 lb

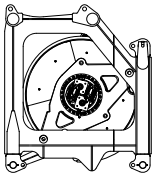

Main Hoist Drum #2 x 1

Length	5,10 m	16' 9"
Width	2,80 m	9' 2"
Height	3,20 m	10' 6"
Weight	38 100 kg	83,820 lb

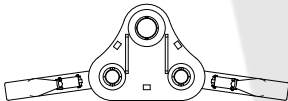

Hook Assembly x 1

Length	5,40 m	17' 9"
Width	1,70 m	5' 7"
Height	1,90 m	6' 3"
Weight	14 500 kg	31,900 lb

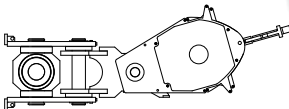

Block Assembly x 1

Length	3,40 m	11' 2"
Width	3,50 m	11' 6"
Height	3,60 m	11' 10"
Weight	39 300 kg	86,460 lb

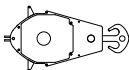

Hook Block 200mton x 1

Length	3,10 m	10' 2"
Width	1,50 m	4' 11"
Height	1,00 m	3' 3"
Weight	7 700 kg	16,940 lb

PROVISIONAL

LWMA SALE & RENTAL

model 31000



boom combinations

14

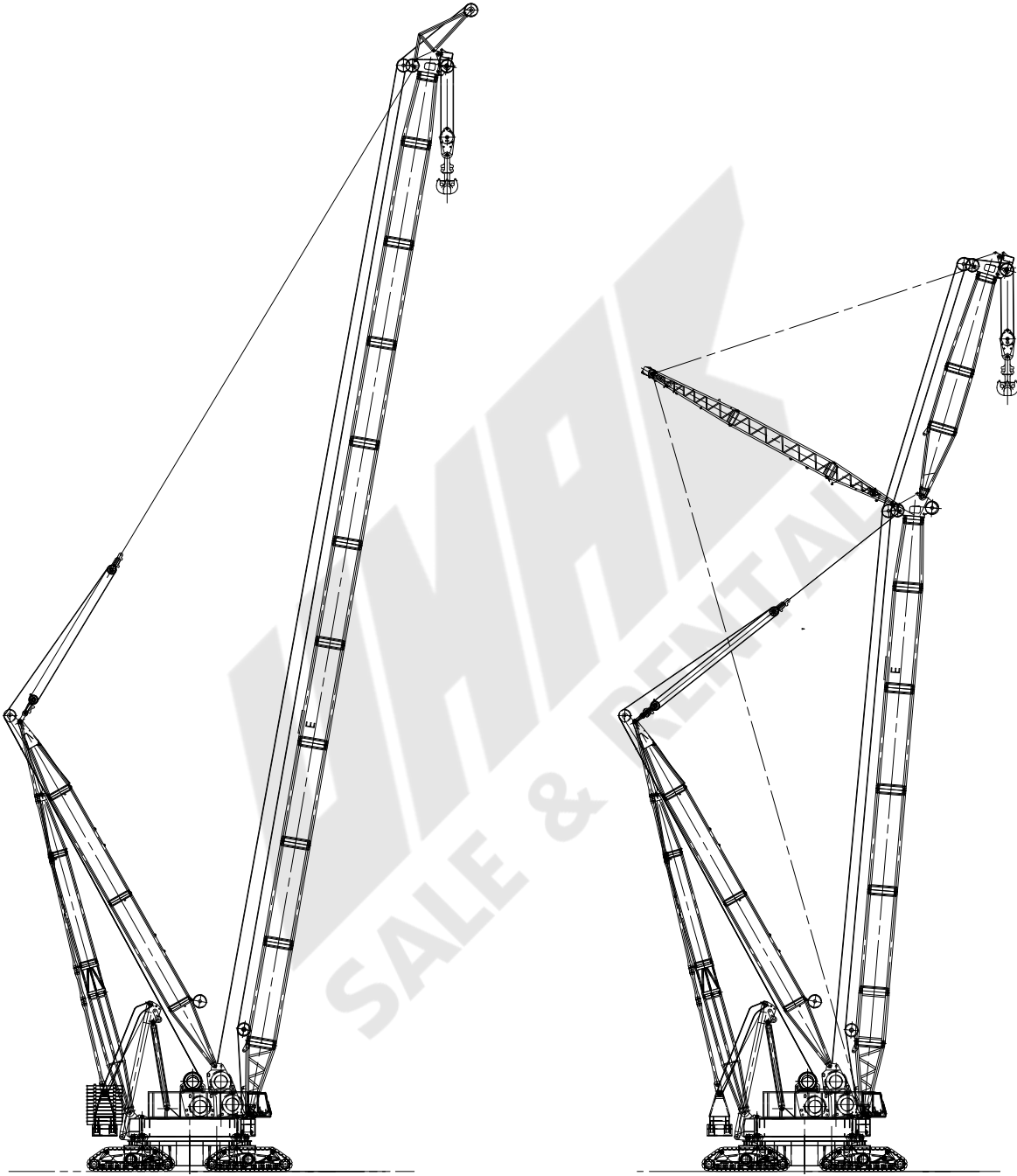

Model 31000
No. 90 Heavy-Lift Main Boom
105 m (344.5 ft)

Model 31000
Fixed Jib on
No. 90 Heavy-Lift Main Boom
84 m (275.6 ft)

PROVISIONAL

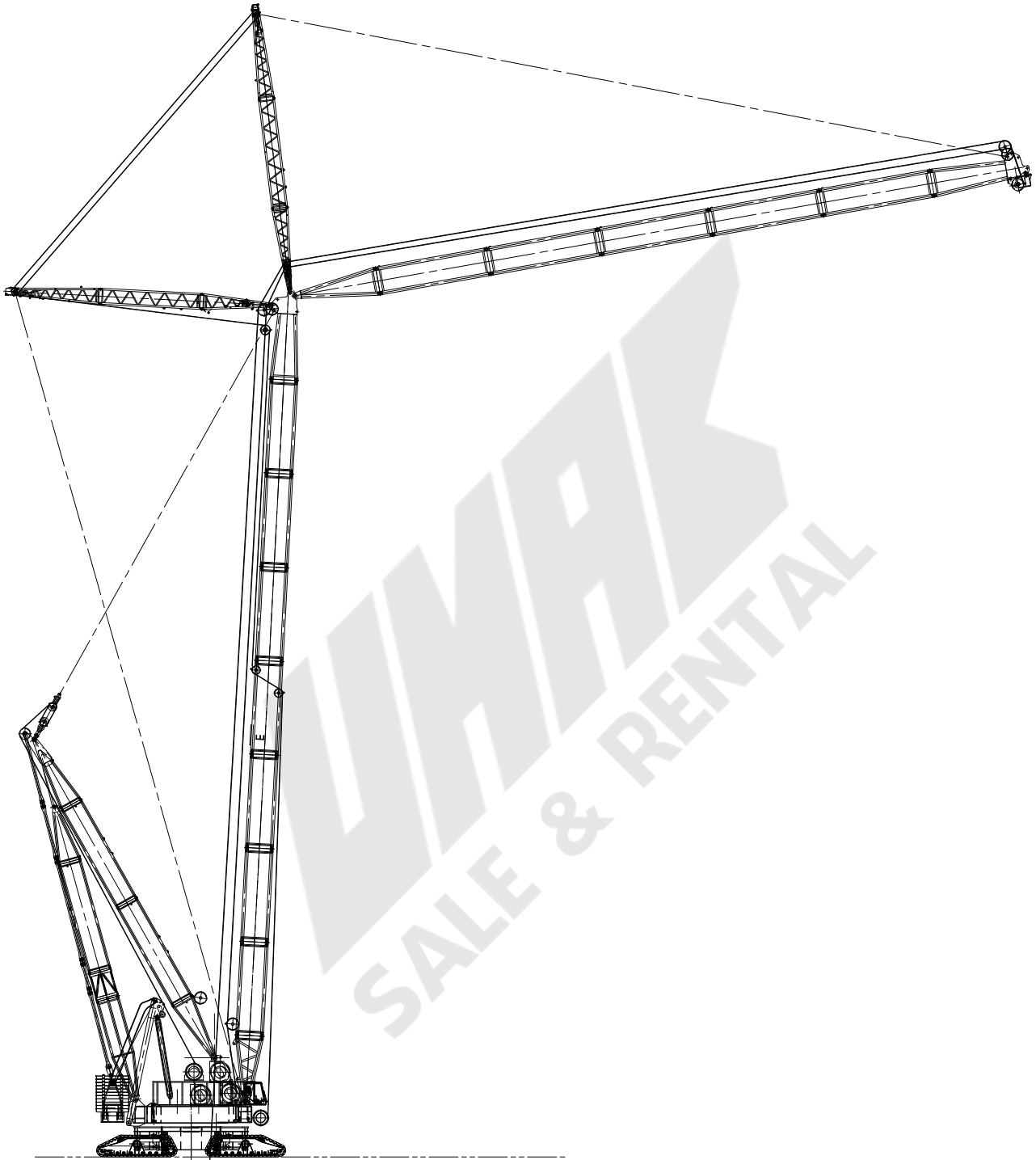

Model 31000
No. 90 Luffing Jib on
No. 91 Heavy-Lift Main Boom
95 m + 102 m (646.3 ft)

PROVISIONAL

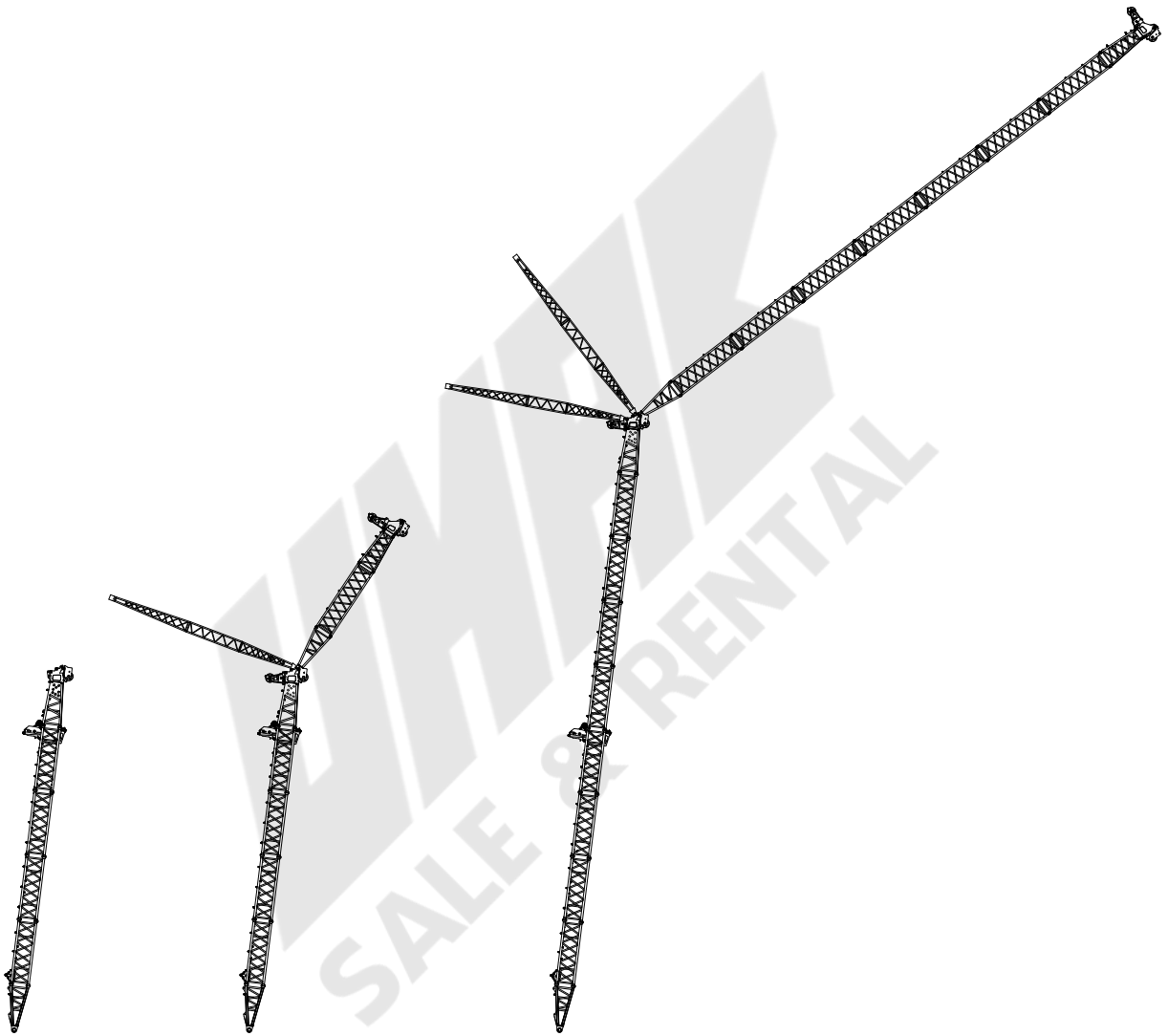

#90 MAIN BOOM

#90 MAIN BOOM +
#91 VESSEL JIB

#90 MAIN BOOM +
#91 LUFFING JIB

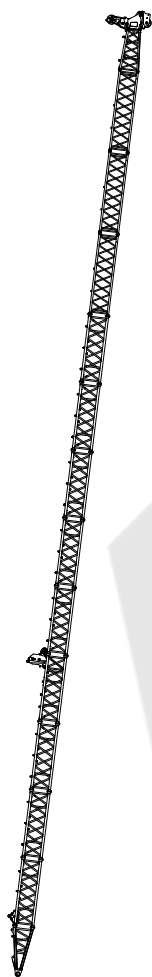

#90/91 MAIN BOOM

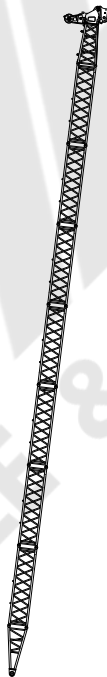

#91 LIGHT BOOM

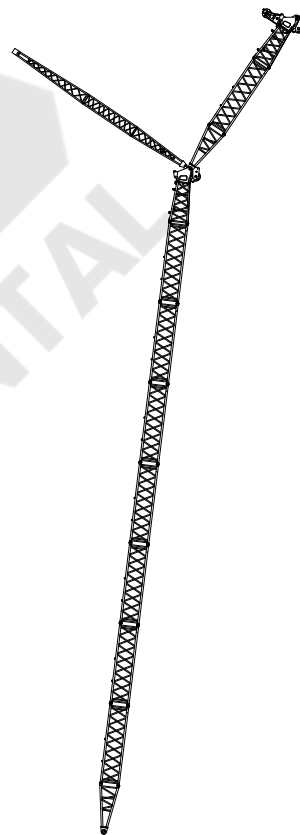

#91 LIGHT BOOM
+ VESSEL JIB

UNIVERSAL
SALE & RENTAL

PROVISIONAL

crane assembly

CONFIDENTIAL

18

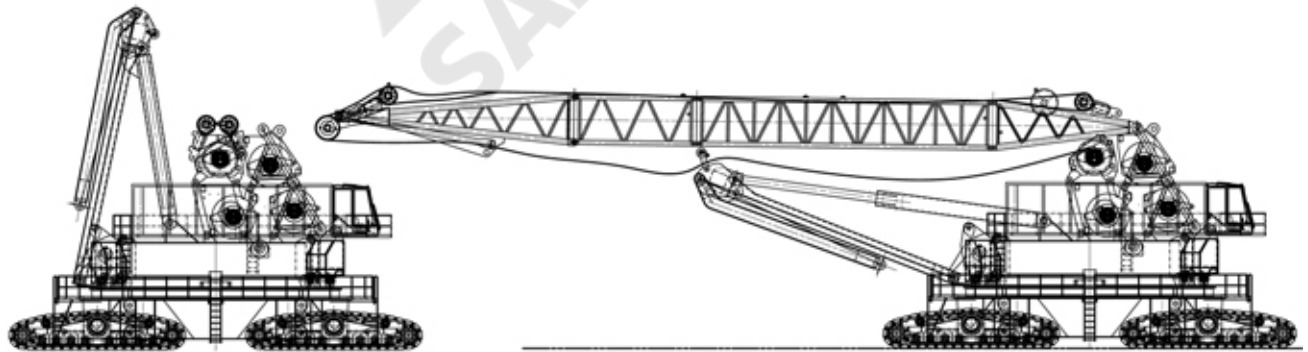
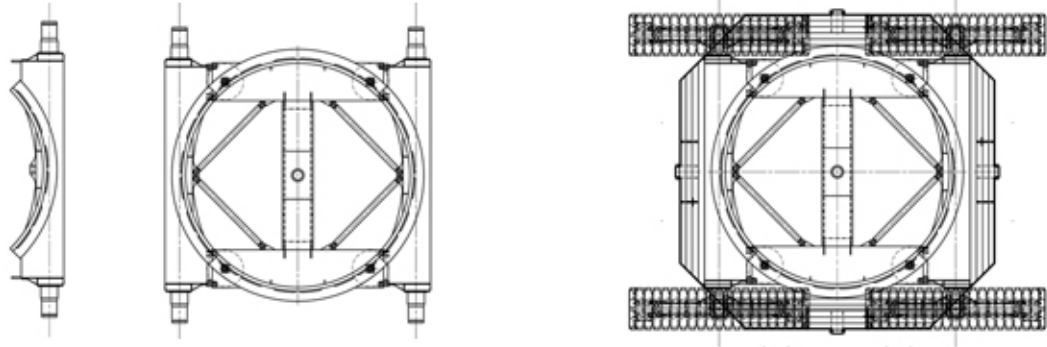

model 31000

PROVISIONAL

crane assembly

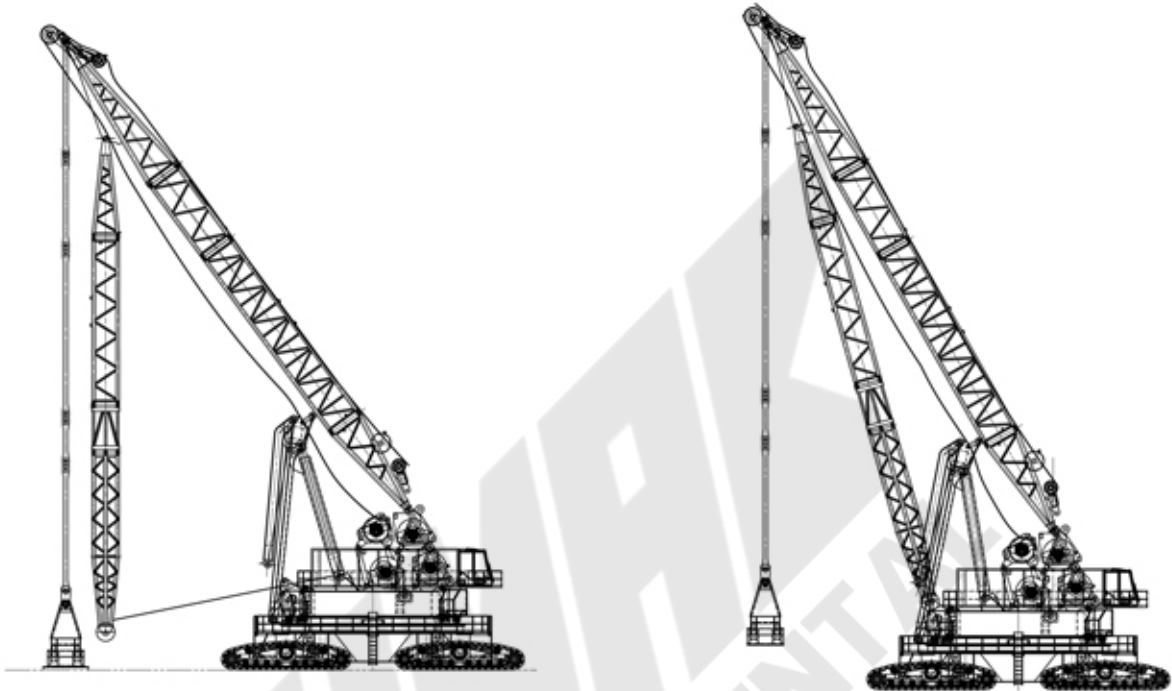
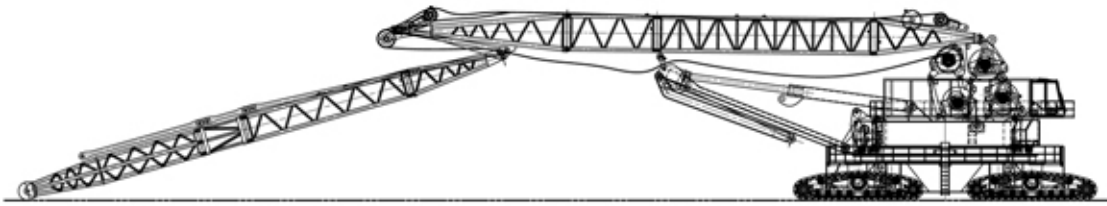

PROVISIONAL

crane assembly

CONFIDENTIAL

20

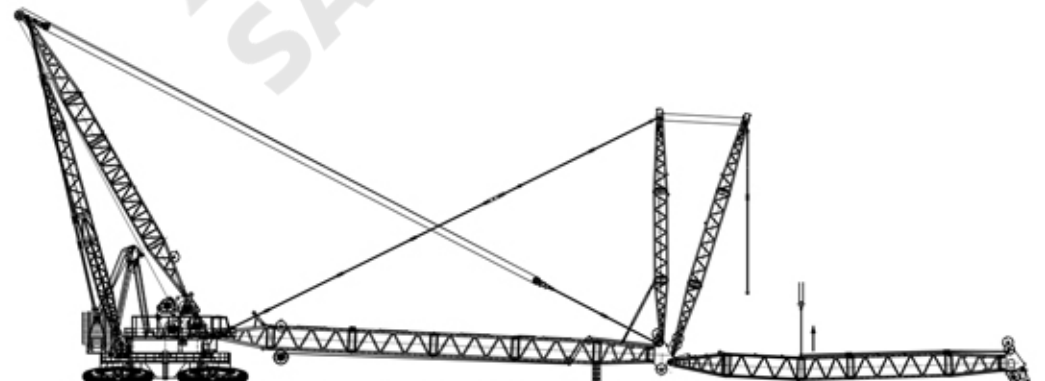
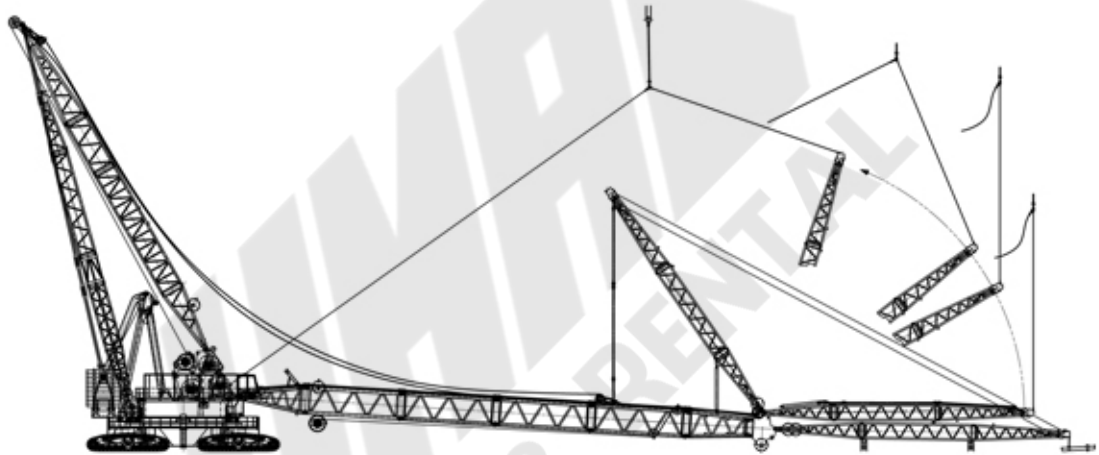

model 31000

PROVISIONAL

crane assembly

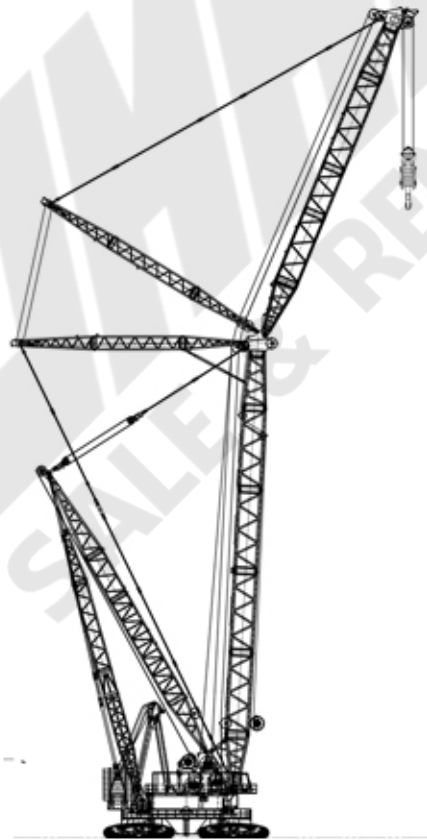
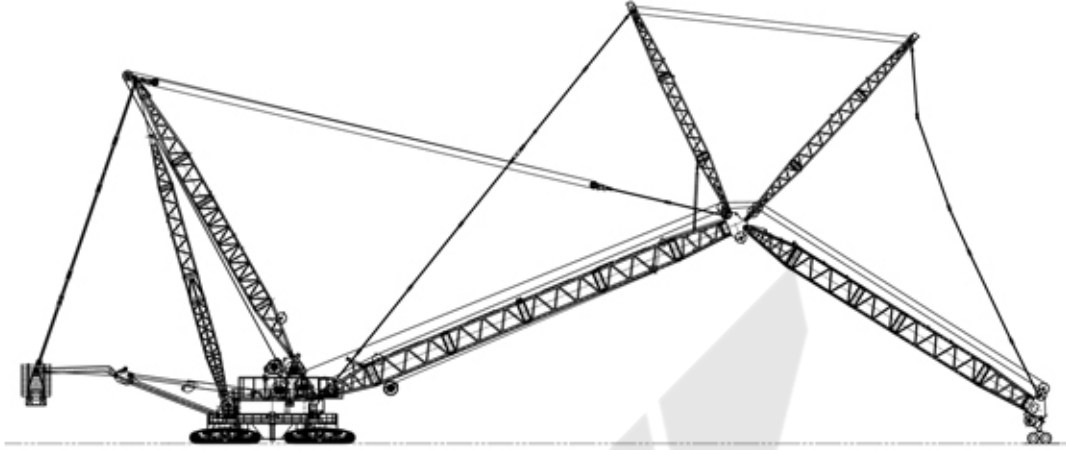

PROVISIONAL

heavy-lift boom range diagrams

CONFIDENTIAL

SUBJECT TO ANSI B30.5 TEST

22

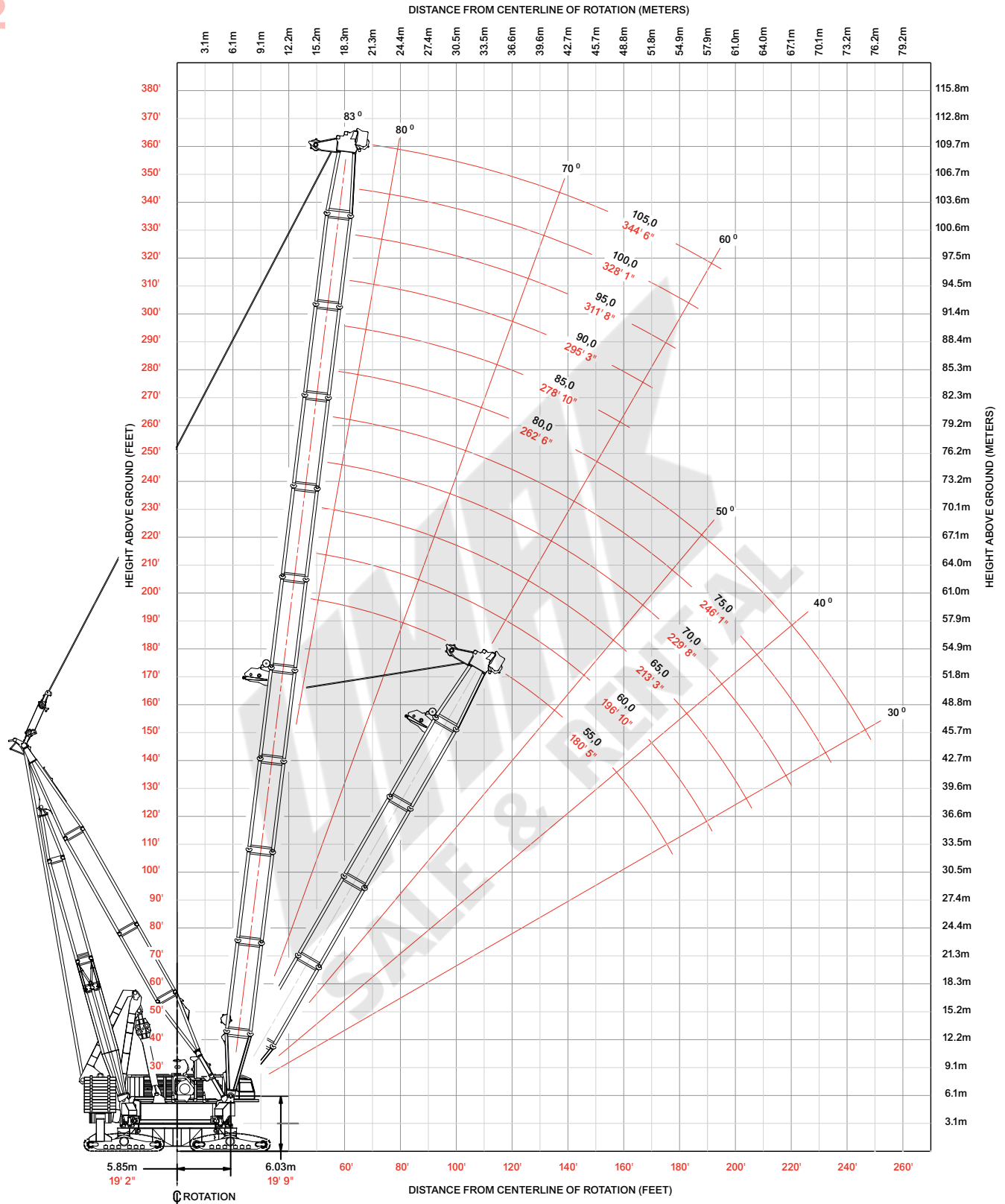

PROVISIONAL

heavy-lift boom load charts

SUBJECT TO ANSI B30.5 TEST

Model 31000 No. 90 Heavy Lift Main Boom

23

949 230 kg (2,092,700 lb) Variable Position Counterweight (VPC)

360° Rating

kg (lb) x 1 000

Boom m (ft)	55 (180)	60 (197)	65 (213)	70 (230)	75 (246)	80 (262)	85 (279)	90 (295)	95 (312)	100 (328)	105 (344)
Radius											
14,6 (48)	2000 (4409)										
15 (50)	2000 (4409)										
16 (55)	1967 (4263)	1883 (4122)									
20 (65)	1675 (3723)	1669 (3707)	1628 (3611)	1575 (3493)	1517 (3361)	1398 (3082)	1284 (2830)	1185 (2613)	1095 (2415)	1003 (2211)	
24 (80)	1432 (3113)	1425 (3097)	1422 (3089)	1402 (3059)	1362 (2972)	1318 (2873)	1267 (2782)	1185 (2613)	1095 (2415)	1003 (2211)	897 (1978)
28 (90)	1243 (2802)	1237 (2787)	1234 (2779)	1227 (2763)	1223 (2745)	1190 (2660)	1157 (2582)	1212 (2506)	1085 (2415)	1003 (2211)	897 (1978)
32 (105)	1043 (2300)	1039 (2290)	1037 (2287)	1033 (2276)	1031 (2273)	1026 (2261)	1024 (2258)	1019 (2247)	999 (2202)	969 (2137)	897 (1978)
36 (120)	892 (1925)	887 (1915)	886 (1911)	881 (1901)	879 (1897)	873 (1885)	872 (1881)	867 (1870)	865 (1866)	861 (1854)	862 (1849)
40 (130)	775 (1731)	771 (1721)	769 (1717)	764 (1706)	762 (1702)	757 (1690)	755 (1687)	750 (1675)	748 (1671)	743 (1659)	741 (1654)
44 (145)	683 (1498)	679 (1487)	677 (1484)	672 (1473)	670 (1469)	664 (1456)	663 (1453)	658 (1441)	656 (1437)	650 (1424)	648 (1420)
48 (160)	608 (1310)	604 (1303)	602 (1300)	597 (1288)	595 (1284)	590 (1272)	588 (1268)	583 (1256)	581 (1252)	575 (1240)	573 (1235)
52 (170)	514 (1144)	542 (1201)	540 (1197)	535 (1186)	533 (1182)	528 (1169)	526 (1166)	521 (1154)	519 (1149)	513 (1137)	511 (1132)
56 (185)		476 (1030)	488 (1066)	483 (1055)	481 (1051)	475 (1038)	474 (1035)	468 (1023)	466 (1018)	461 (1006)	459 (1001)
60 (195)			441 (991)	439 (980)	437 (976)	431 (963)	429 (960)	424 (948)	422 (943)	416 (931)	414 (926)
64 (210)				400 (882)	398 (878)	392 (865)	391 (862)	385 (850)	383 (845)	378 (833)	376 (828)
68 (225)					365 (794)	359 (781)	357 (778)	352 (766)	350 (761)	344 (749)	342 (744)
72 (235)						329 (732)	328 (728)	322 (716)	320 (712)	315 (699)	312 (695)
76 (250)							302 (662)	296 (650)	294 (645)	288 (633)	286 (628)
80 (260)								273 (610)	271 (606)	365 (593)	263 (589)
84 (275)									249 (552)	244 (539)	242 (535)
88 (290)									230 (504)	225 (491)	223 (487)
92 (300)										207 (462)	205 (458)
94 (310)											197 (430)
96 (320)											189 (398)

PROVISIONAL

Manitowoc Crane Care

24

Crane Care is Manitowoc's comprehensive service and support program. It includes classroom and on-site training, prompt parts availability, expert field service, technical support and documentation — for every one of the more than 7,000 Manitowoc cranes currently in use throughout the world.

That's commitment you won't find anywhere else.

That's **Crane Care**.

Service Training

Manitowoc specialists work with you in our training center and in the field to make sure you know how to get maximum performance, reliability and life from your cranes.

Manitowoc Cranes Technical Training Center provides valuable multi-level training, which is available for all models and attachments, in the following format:

- **Basic** – Provides technicians with the basic skills required in our Level I and II classes covering hydraulic and electrical theory and schematics, pump, motor, control, and LMI operation and the use of meters and gauges.
- **Level 1** – This model-specific class covers theory and offers hands-on training and trouble shooting or all crane systems.
- **Level 2** – This model-specific class provides in-depth coverage of all crane systems and components, and advanced troubleshooting of simulated faults. (Requires Level 1.)
- **Level 3 / Master** – Covering all EPIC models and the 4100W, this class stresses high level system knowledge and trouble shooting of simulated faults. (Requires Level 2.)

Parts Availability

Genuine Manitowoc replacement parts are accessible through your distributor 24 hours a day, 7 days a week, 365 days a year.

Service Interval Kits

Provides all the parts required by Manitowoc's Preventative Maintenance Checklist.

Hydraulic Filter Kit

- Consists of the following:
- Filter Element - Hydraulic in Tank (4)

Cummins Model QSZ15-C600 Diesel

– Service Interval Kits

200 Hour Kit

Consists of the following:

Engine

- Filter Oil (2)
- Filter Water (2)
- Filter Fuel (2)

1,000 Hour Kit

Consists of the following:

Engine

- Filter Air Cleaner - Primary (2)
- Filter Oil (2)
- Filter Water (2)
- Filter Fuel (2)

Hydraulic

- Filter Element - Hydraulic in Tank (4)
- Element - Hydraulic Tank Breather (1)

2,000 Hour Kit

Consists of the following:

Engine

- Filter, Air Cleaner - Primary (2)
- Filter, Air Cleaner - Safety (2)
- Filter, Oil (2)
- Filter, Water (2)
- Filter, Fuel (2)
- Ether, (Bottle) (2)
- Sensor, Coolant Level (2)
- Belt, Fan (2)
- Belt, Alternator (set of two) (2)
- Filter, Element (2)

Hydraulic

- Filter Element - No substitutions allowed
- Filter - Hydraulic In-Tank Suction (4)

Kit, Engine Coolant Additive (SCA) Test (2)

Kit, Seal (for hydraulic in tank filter) (1)

Seal, Radial (for air cleaner) (2)

Hydraulic Test Kit

Protect your investment by demanding Genuine Manitowoc Parts Service Kits. The Hydraulic Service Kit consist of the following:

- All hydraulic fittings to access all pressures and flows
- Hydraulic flow meters and pressure gauges to record hydraulic data.
- Electrical "Break out" harnesses to access voltages on all electrical circuits on all machines.
- Fluke® Digital volt ohm meter, as used in all Manitowoc service literature.

U.S. Standard Tools Kit

All standard tools needed to properly maintain and service your crane. (Does not include torque wrench.)

Field Service

Factory-trained service experts are always ready to help maintain your crane's peak performance.

For a worldwide listing of dealer locations, please consult our website at:

www.manitowoc.com

Technical Support

Manitowoc's dealer network and factory personnel are available 24 hours a day, 7 days a week, 365 days a year to answer your technical questions and more, with the help of computerized programs that simplify crane selection, lift planning and ground-bearing calculations.

For a worldwide listing of dealer locations, please consult our website at:

www.manitowoc.com

Technical Documentation

Manitowoc has the industry's most extensive documentation, and the easiest to understand, available in major languages and formats that include print, disk and videotape.

Additional copies available through your Authorized Maniowoc Distributor.

- **Crane Operator's Manual**
- **Crane Parts Manual**
- **Crane Capacity Manual**
- **Crane Vendor Manual**
- **Service Manual (EPIC)**
- **Luffing Jib Operator's/Parts Manual**
- **Capacity Chart Manual - Attachments**

CD rom versions of the Operator's and Parts Manuals are shipped with each crane.

Also available are the following CDs:

- Crane Care Owner CD –
- Ground Bearing Pressure Estimator CD
- Crane Selection and Planning Software (CompuCRANE©)
- EPIC® Crane Library CD consisting of capacity charts, range diagrams, wire rope specifications, travel specifications, crane weights, counterweight arrangements, luffing jib raising procedures, operating range diagrams, drum and lagging charts, boom rigging drawings, jib rigging drawings, outline dimensions and wind condition charts.

Available from your Authorized Maniowoc Cranes Distributor, these videos are available in NTSC, PAL and SECAM formats.

- Your Capacity Chart Video
- Respect the Limits Video
- Crane Safety Video
- Boom Inspection/Repair Video

Crane Care Package

Manitowoc has assembled all of the available literature, CD's and videos listed above plus several Maniowoc premiums into one complete Crane Care Package.





Regional Headquarters

Americas

Manitowoc, Wisconsin, USA
Tel: +1 920 684 6621
Fax: +1 920 683 6278

Shady Grove, Pennsylvania, USA
Tel: +1 717 597 8121
Fax: +1 717 597 4062

Regional Offices

Americas

Brazil

Alphaville
Tel: +55 11 3103 0200
Fax: +55 11 4191 1471

Mexico

Monterrey
Tel: +52 81 8124 0128
Fax: +52 81 8124 0129

Europe, Middle East, Africa

Algeria

Hydra
Tel: +21 3 21 48 1173
Fax: +21 3 21 48 1454

Czech Republic

Netvorice
Tel: +420 317 78 9313
Fax: +420 317 78 9314

France

Baudemont
Tel: +33 385 28 2589
Fax: +33 385 28 0430

Cergy

Tel: +33 130 31 3150
Fax: +33 130 38 6085

Decines

Tel: +33 472 81 5000
Fax: +33 472 81 5010

Germany

Langenfeld
Tel: +49 21 73 8909-0
Fax: +49 21 73 8909 30

Hungary

Budapest
Tel: +36 13 39 8622
Fax: +36 13 39 8622

Italy

Parabiago
Tel: +390 331 49 3311
Fax: +390 331 49 3330

Europe, Middle East, Africa

Ecully, France
Tel: +33 472 18 2020
Fax: +33 472 18 2000

Netherlands

Breda
Tel: +31 76 578 3999
Fax: +31 76 578 3978

Poland

Warsaw
Tel: +48 22 843 3824
Fax: +48 22 843 3471

Portugal

Alfena
Tel: +351 229 69 8840
Fax: +351 229 69 8848

Lisbon

Tel: +351 212 109 340
Fax: +351 212 109 349

Russia

Moscow
Tel: +7 495 641 2359
Fax: +7 495 641 2358

U.A.E.

Dubai
Tel: +971 4 3381 861
Fax: +971 4 3382 343

U. K.

Middlesex
Tel: +44 1 895 43 0053
Fax: +44 1 895 45 9500

Sunderland

Tel: +44 191 522 2000
Fax: +44 191 522 2052

Asia – Pacific

Australia

Melbourne
Tel: +61 3 9 336 1300
Fax: +61 3 9 336 1322

Sydney

Tel: +61 2 9 896 4433
Fax: +61 2 9 896 3122

Asia – Pacific

Shanghai, China
Tel: +86 21 51113579
Fax: +86 21 51113578

Singapore

Tel: +65 6264 1188
Fax: +65 6862 4142

China

Beijing
Tel: +86 10 58674761
Fax: +86 10 58674760

Xi'an

Tel: +86 29 87891465
Fax: +86 29 87884504

Korea

Seoul
Tel: +82 2 3439 0400
Fax: +82 2 3439 0405

Philippines

Makati City
Tel: +63 2 844 9437
Fax: +63 2 844 4712

Factories

Brazil

Alphaville

China

Zhangjiagang

France

Charlieu
La Clayette
Moulins

Germany

Wilhelmshaven

India

Calcutta
Pune

Italy

Niella Tanaro

Portugal

Baltar
Fânzeres

Slovakia

Saris

U.S.A.

Manitowoc
Port Washington
Shady Grove

