

Raupenkran • Crawler Crane Grue sur chenilles

LR 1750

Technische Daten
Technical Data
Caractéristiques techniques

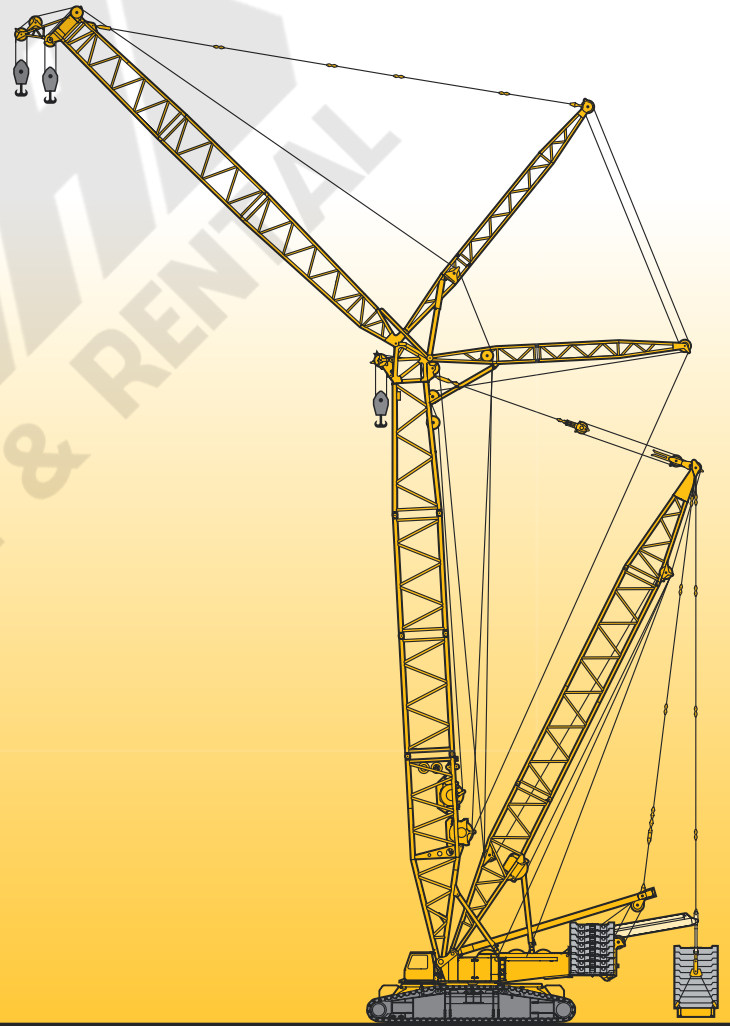

LIEBHERR

Technische Beschreibung

Technical description

Description techniques

Raupenfahrwerk

Rahmen	Eigengefertigte, verwindungssteife Kastenkonstruktion aus hochfestem Feinkorn-Baustahl bestehend aus Raupenmitteleil und zwei Raupenträgern. Die Raupenträger werden hydraulisch angebolzt.
Laufwerk	Wartungsfreies, schmutzgeschütztes Raupenfahrwerk mit 1,5 m (2 m als Option) breiten Bodenplatten und Zentralschmieranlage für Turas- und Laufrollenlagerung.
Fahrtrieb	Pro Raupenträger 1 (2 als Option) hydraulischer Fahrtrieb bestehend aus Axialkolben-Verstellmotor, Planetengetriebe mit federbelasteter, hydraulisch löfbarer Fahrwerksbremse und Turas. Die Raupenkettens sind synchron sowie unabhängig und gegenläufig zueinander steuerbar.
Zentralballast	45 t, bestehend aus 2 Grundplatten á 10 t und 2 Platten á 12,5 t.

Kranoberwagen

Rahmen	Eigengefertigte, verwindungssteife Schweißkonstruktion aus hochfestem Feinkorn-Baustahl. Verbindung zum Raupenfahrwerk über 3-reihige Rollendrehverbindung, 360° unbegrenzt schwenkbar.
Demontagvorrichtung A-Bock	Zur Demontage von A-Bock, Winde 4 und kompletter Einscherung.
Kranmotor	8-Zylinder-Turbo-Diesel, Fabrikat Liebherr, Typ D9408 TI-E A4, wassergekühlt, Leistung nach DIN 400kW (544 PS) bei 1800 min ⁻¹ , max. Drehmoment 2425 Nm bei 1000 min ⁻¹ . Der Motor erfüllt die EU-Richtlinie 97/68/EG Stufe II und ist nach EPA/CARB und Tier 2 zertifiziert. Kraftstoffbehälter 820 l.
Krantrieb	Diesel-hydraulisch über Pumpenverteilergetriebe mit 6 Axialkolben-Verstellpumpen mit Leistungsregelung, geschlossene Ölkreisläufe.
Kransteuerung	Servosteuerung mit elektronischer Gleichlauf-einrichtung über drei 4fach Kreuzsteuerhebel und zwei 2fach Steuerhebel. Stufenlose Regulierung der Kranbewegungen durch Verstellen der Hydraulikpumpen und zusätzlich durch Veränderung der Dieselmotor-Drehzahl.
Winden 2 und 4	Hydraulisch angetriebene Seiltrommel über Axialkolben-Verstellmotor und Planetengetriebe mit federbelasteter, hydraulisch löfbarer Haltebremse. Verschleißfreies Bremsen beim Senkvorgang über geschlossene Ölkreisläufe. Winde 2 - Hubwerk, Winde 4 - Einziehwerk. Zusätzlich Hilfswinde zum Einscheren von Seilen.
Drehwerk	1 Drehwerk (2 bzw. 3 als Option), hydraulisch angetrieben über Axialkolben-Verstellmotor und Planetengetriebe mit federbelasteter, hydraulisch löfbarer Haltebremse. Verschleißfreies Bremsen über geschlossenen Ölkreislauf.
Krankabine	Großräumige Kabine in Stahlblechausführung, seitlich schwenkbar und nach hinten neigbar, mit Bedienungs- und Kontrollinstrumenten und motorunabhängiger Warmwasserheizung (Klimaanlage als Option).
Sicherheits-einrichtungen	LICCON-Überlastanlage mit Testsystem, Hubendbegrenzung, elektronische Neigungsanzeige, Sicherheitsventile gegen Rohr- und Schlauchbrüche, Windmesser.

Elektrische Anlage	Datenbus-Technik, 24 V Gleichstrom, 2 Batterien á 170 Ah.
Drehbühnenballast	170 t, bestehend aus 2 Konsolen á 10 t und 12 Platten á 12,5 t.

Auslegersysteme

SL - Hauptausleger	SL 28 – 133 m (SL 112 m – 133 m nur mit Derrick), System 2826.20 / 2421.10 Anlenkstück 12 m, Zwischenstück 7 m und 14 m, Reduzierstück 7 m, Kopfadapter 8,4 m, 400 t-Kopfstück 0,6 m, Anti-Rückfallzylinder.
S - Hauptausleger	S 21 – 140 m (S 91 m – 140 m nur mit Derrick), System 2826.20 / 2826.10 Anlenkstück 12 m, Zwischenstücke 7 m und 14 m, Kopfstück 9 m, Rollensatz 400 t (600 t als Option), Anti-Rückfallzylinder.
D-Derrickausleger	D 31,5 m, System 2421.10 Anlenkstück 10,5 m, Zwischenstück 14 m, Kopfstück 7 m, Verstellflasche, Anti-Rückfallzylinder.
W-Wippbare Gitterspitze	W 28 – 105 m, System 2421.10 / 2421.8 Anlenkstück 12 m, Zwischenstücke 7 m und 14 m, Kopfadapter 8,4 m, 400 t-Kopfstück 0,6 m, Anti-Rückfalleinrichtung, A-Bock 1 und 2.
B-Schwebeballast	Schwebeballastpalette mit Ausgleichszylinder und hydraulisch teleskopierbarer Führung für max. 400 t Derrickballast bei max. 20 m Gegenausladung.
BW-Ballastwagen	Ballastwagen mit Ausgleichzylinder und hydraulisch teleskopierbarer Führung für max. 400 t Derrickballast bei max. 20 m Ausladung.

Zusatzausrüstung

Winden 1, 3, 5 und 6	Winde 1 – Hubwerk, Winde 3 – Verstellung Hauptausleger/D-Betrieb, Winde 5 – Verstellung wippbare Gitterspitze, Winde 6 – Zusatzhubwerk.
Hydraulische Kranabstützung	Zur Traglaststeigerung, Reduzierung der Bodendrücke und Nivellierung des Krans.
Ballast	Zentralballast 95 t, zusätzlich 4 Platten á 12,5 t. Drehbühnenballast 245 t, zusätzlich 6 Platten á 12,5 t. Schwebeballast B 387,5 t, 31 Platten á 12,5 t für gesamt 400 t Derrickballast. Ballastwagen BW 362,5 t, 29 Platten á 12,5 t für gesamt 400 t Derrickballast.
Mechanische Zusatzabstützung	Zum Aufrichten langer Auslegerkombinationen ohne Derrickballast.
Hydraulische Montageabstützung	Zum Anheben des Grundgerätes bei Montage/Demontage.
Montagezylinder Raupenträger	Zur Selbst-Montage/Demontage der Raupenträger mit dem Kran.
Mobile Bolzenzieheinrichtung	Zur Montage/Demontage der Ausleger-Zwischenstücke.
Quick Connection	Schnellverbindung zum leichten Trennen von Kranoberwagen und Raupenfahrwerk.
Mastnasen	Mastnase 60 t, zum Anbau an SL-, W-Kopf. Mastnase 60 t, zum Anbau an S-Kopf.

Weitere Zusatzausrüstungen auf Anfrage.

Technische Beschreibung Technical description Description techniques

Crawler travel gear

Frame	Self-manufactured, torsion-resistant box-type design of high-tensile grain refined structural steel, comprising crawler centre section and two crawler carriers. The crawler carriers are pinned hydraulically.
Travel gear	Maintenance-free, dirt-protected crawler travel gear with 1.5 m (2.0 m optional) track pads and centralized lubrication system for tumbler and track roller bearings.
Travel drive	1 (optionally 2) hydraulic travel drives per crawler carrier, comprising axial piston variable displacement motor, planetary gear with spring-loaded, hydraulically releasable travel brake and tumbler. The crawler chains are controllable synchronously, independently and opposed to one another.
Central ballast	45 t, consisting of 2 base slabs 10 t each and 2 slabs 12.5 t each.

Crane superstructure

Frame	Self-manufactured, torsion-resistant weldment of high-tensile grain refined structural steel. Connected to crawler travel gear by a 3-row roller slewing rim for 360° continuous rotation.
Dismounting device A-Frame	For dismantling the A-frame, winch 4 and the entire reeving.
Crane engine	8-cylinder turbo-charged Liebherr Diesel engine, type D9408 TI-E A4, water-cooled, output acc. to DIN 400 kW (544 h.p.) at 1800 min ⁻¹ , max. torque 2425 Nm at 1000 min ⁻¹ . The engine corresponds to the EU directive 97/68/EG step II and is certified acc. to EPA/CARB and Tier 2. Fuel reservoir 820 l.
Crane drive	Diesel-hydraulic by pump distribution gear with 6 axial piston variable displacement pumps with capacity control within closed oil circuits.
Crane control	Servo-control with electronic synchronizing device by three four-way control levers and two two-way control levers (joy-stick type). Continuous control of the crane motions by variation of the hydraulic pumps, additionally by variation of the Diesel engine speed.
Winches 2 and 4	Hydraulically driven cable drums by axial piston variable displacement motor and planetary gear with spring-loaded, hydraulically releasable static brake. Wearfree braking function during lowering by closed oil circuits. Winch 2 – hoist gear, winch 4 – derrick gear. Additional auxiliary winch for reeving of cables.
Slewing gear	1 slewing gear (optionally 2 or 3), hydraulically powered by axial piston variable displacement motors and planetary gear with spring-loaded, hydraulically releasable static brake. Wearfree braking function by closed oil circuits.
Crane cabin	Spacious, all-steel construction cabin, swivelling sideways and tiltable backwards, with operating and control instruments. Self-contained warm-water heating (optionally air-conditioning system).

Safety devices	LICCON safe load indicator with test system, hoist limit switches, electronic inclinometer, safety valves for the prevention of pipe and hose ruptures.
Electrical system	Data bus technique, 24 V DC, 2 batteries 170 Ah each.
Counterweight on superstructure	170 t, consisting of 2 brackets of 10 t each and 12 slabs of 12.5 t each.

Boom system

SL - Main boom	SL 28 – 133 m (SL 112 m – 133 m, exclusively with derrick), system 2826.20 / 2421.10 Base section 12 m, intermediate sections 7 m and 14 m, reduction section 7 m, boom head adapter 8.4 m, 400-t head section 0.6 m, safety retaining ram.
S - Main boom	S 21 – 140 m (S 91 m – 140 m, exclusively with derrick), system 2826.20 / 2826.10 Base section 12 m, intermediate sections 7 m and 14 m, head section 9 m, pulley set 400 t (optional 600 t), safety retaining ram.
D - Derrick boom	D 31.5 m, system 2421.10 Base section 10.5 m, intermediate section 14 m, head section 7 m, derricking pulley block, safety retaining ram.
W - luffing fly jib	W 28 – 105 m, system 2421.10 / 2421.8 Base section 12 m, intermediate sections 7 m and 14 m, boom head adapter 8.4 m, 400-t head section 0.6 m, safety retaining ram, A-frame 1 and 2.
B - Suspended ballast	Suspended ballast pallet with compensating ram and hydraulic telescoping guide for max. 400 t derrick ballast at max. 20 m counter-radius.
BW - Ballast trailer	Ballast trailer with compensating ram and hydraulic telescoping guide for max. 400 t derrick ballast at max. 20 m counter-radius.

Optional equipment

Winches 1,3,5 and 6	Winch 1 – hoist gear, winch 3 – derricking main boom/D-operation, winch 5 – derricking luffing fly jib, winch 6 auxiliary hoist gear.
Hydraulic crane supporting system	For load capacity increase, ground pressure reduction and crane levelling.
Ballast	Central ballast 95 t, additionally 4 slabs of 12.5 t each. Superstructure ballast 245 t, additionally 6 slabs of 12.5 t each. Suspended ballast B 387.5 t, 31 slabs of 12.5 t each for a total of 400 t derrick ballast. Ballast trailer BW 362.5 t, 29 slabs of 12.5 t each for a total of 400 t derrick ballast.
Additional Mechanical supports	For the erection of longer boom combinations without derrick ballast.
Hydraulic mounting supports	For raising the basic machine during assembly/disassembly.
Mounting rams crawler carriers	For the assembly/disassembly of the crawler carriers by the crane itself.
Portable pin pulling device	For the assembly/disassembly of boom intermediate sections.
Quick Connection	Rapid coupling system to facilitate dismantling the crane superstructure from the crawler travel gear.
Whip lines	Whip line 60 t, to be fitted to the SL-, W-head. Whip line 60 t, to be fitted to the S-head.

Further equipment items on request.

Technische Beschreibung

Technical description

Description techniques

Train de chenilles

Châssis	Fabrication Liebherr, construction en caisson indéformable, en acier à grain fin à haute résistance. Constitué d'une partie centrale et de deux supports de chenilles. Les supports de chenilles sont montés hydrauliquement.
Train de chenilles	Train de chenilles ne nécessitant pas d'entretien et protégé contre les impuretés, équipé de tuiles de 1,5 m de large (2,0 m en option) et d'un dispositif de graissage centralisé pour les paliers des barbotins et des galets de roulement.
Transmission	1 transmission hydraulique (2 en option) par support de chenilles, comprenant chacune un moteur à pistons axiaux à cylindrée variable, un train planétaire avec frein à ressort et purge hydraulique et des barbotins. Les chaînes peuvent être commandées synchroniquement, indépendamment l'une de l'autre et en sens inverse l'une par rapport à l'autre.
Contrepoids central	45 t, comprenant 2 plaques de base de 10 t et 2 plaques de 12,5 t.

Partie tournante

Châssis	Fabrication Liebherr, construction soudée indéformable, en acier grain fin à haute résistance. Liaison par couronne d'orientation à triple rangée de rouleaux, orientation illimitée à 360°.
Dispositif de démontage du chevalet de relevage A	Pour le démontage du chevalet de relevage A, du treuil 4 et du mouflage complet.
Moteur de la grue	Moteur diesel Liebherr, 8 cylindres, Type D 9408 TI-E A4, refroidissement par eau, puissance selon DIN 400 kW (544 PS) à 1800 min ⁻¹ , couple max. 2425 Nm à 1000 min ⁻¹ . Le moteur correspond à la directive EU 97/68/EG stage II et est certifié selon EPA/CARB et Tier 2. Capacité du réservoir de carburant: 820 l.
Entraînement de grue	Entraînement Diesel hydraulique via un mécanisme de distribution de pompes avec 6 pompes à débit variable à pistons axiaux, avec réglage de la puissance en circuits hydrauliques fermés.
Commande de la grue	Servo-commande avec dispositif de synchronisation électronique, via 4 manipulateurs en croix et 3 manipulateurs à deux positions. Commande des mouvements de la grue en continu, par régulation du débit des pompes et du régime du moteur Diesel.
Treuils 2 et 4	Tambour de câble à entraînement hydraulique, via un moteur à pistons axiaux à cylindrée variable, un train planétaire avec frein à ressort piloté hydrauliquement. Frein quasi-inusable via des circuits hydrauliques fermés pour les mouvements de descente. Treuil 2 – Treuil de levage, Treuil 4 – Mécanisme de relevage. Supplémentaire treuil auxiliaire pour le mouflage des câbles.

Mécanisme d'orientation	1 mécanisme d'orientation (2 ou 3 en option), à entraînement hydraulique via un moteur à pistons axiaux à cylindrée variable et un train planétaire avec frein à ressort et piloté hydrauliquement. Frein quasi-inusable via des circuits hydrauliques fermés.
Cabine du grutier	Cabine spacieuse en tôle d'acier galvanisée, pivotable latéralement et inclinable vers l'arrière, dotée de tous les éléments de contrôle et de commande et d'un système de chauffage par eau chaude indépendant du moteur (climatisation en option).
Dispositifs de sécurité	Contrôleur de charges "LICCON" avec système de test, fin de course de levage, affichage électronique de l'inclinaison, clapets de sécurité contre la rupture de tuyaux et flexibles, anémomètre.
Installation électrique	Technologie de bus de données, 24 V en continu, 2 batteries de 170 Ah chacune.
Contrepoids de la partie tournante	170 t, comprenant 2 plaques de 10 t et 12 plaques de 12,5 t chacune.

Système de flèches

Flèche principale SL	SL de 28 à 133 m (SL de 112 m à 133 m uniquement avec Derrick), système 2826.20 / 2421.10. Élément de base de 12 m, éléments intermédiaires de 7 m et 14 m, réducteur de 7 m, adaptateur de tête de 8,4 m, élément de tête de 400 t et de 0,6 m, vérin anti-retour.
Flèche principale S	S de 21 à 140 m (S de 91 m à 140 m uniquement avec Derrick), système 2826.20 / 2826.10. Élément de base de 12 m, éléments intermédiaires de 7 m et 14 m, élément de tête de 9 m, jeu de roues de 400 t (600 t en option), vérin anti-retour.
Flèche Derrick D	D de 31,5 m, système 2421.10. Élément de base de 10,5 m, élément intermédiaire de 14 m, élément de tête de 7 m, palonnier de renvoi, vérin anti-retour.
Fléchette treillis à volée variable W	W de 28 à 105 m, système 2421.10 / 2421.8. Élément de base de 12 m, éléments intermédiaires de 7 m et 14 m, adaptateur de tête de 8,4 m, élément de tête de 400 t et de 0,6 m, dispositif anti-retour, chevalet de relevage A 1 et 2.
Contrepoids suspendu B	Palette de contrepoids suspendu avec vérin de guidage et poutre de télescopage de contrepoids, pour un contrepoids Derrick de 400 t maximum et une contre-portée maximale de 20 m.
Chariot support de contrepoids BW	Chariot support de contrepoids avec vérin de guidage et poutre de télescopage de contrepoids, pour un contrepoids Derrick de 400 t maximum et une contre-portée maximale de 20 m.

Technische Beschreibung

Technical description

Description techniques

Equipement additionnel

Treuils 1,3,5 et 6	Treuil 1 – Treuil de levage, treuil 3 – treuil de manoeuvre de la flèche principale/Fonctionnement D. Treuil 5 – treuil de manoeuvre de la fléchette treillis à volée variable, treuil 6 - treuil de levage auxiliaire.
Calage hydraulique	Pour augmenter la capacité, réduction de la réaction au sol et mise à niveau de la grue.
Contrepoids	Contrepoids central de 95 t, plus 4 plaques de 12,5 t. Contrepoids de la partie tournante de 245 t, plus 6 plaques de 12,5 t. Contrepoids suspendu B de 387,5 t, 31 plaques de 12,5 t pour un contrepoids Derrick total de 400 t. Porteur de lest BW de 362,5 t, 29 plaques de 12,5 t pour un contrepoids Derrick total de 400 t.
Stabilisateurs mécaniques supplémentaires	Pour le relevage des combinaisons de flèches longues sans contrepoids Derrick.
Stabilisateurs de montage hydrauliques	Pour le levage de la machine de base lors du montage / démontage.
Vérin de montage des supports de chenilles	Pour le montage / démontage des supports de chenilles avec la grue.
Dispositif d'extraction d'axes mobile	Pour le montage / démontage des éléments intermédiaires de la flèche.
Raccord rapide	Raccord rapide permettant de désolidariser facilement la partie tournante du train de chenilles.
Poulies brin simple	Poulie brin simple de 60 t, pour le montage sur la tête de la flèche principale SL, de la fléchette W. Poulie brin simple de 60 t, pour le montage sur la tête de la flèche S.

Autres équipements additionnels à la demande.

Maße Dimensions Encombrement

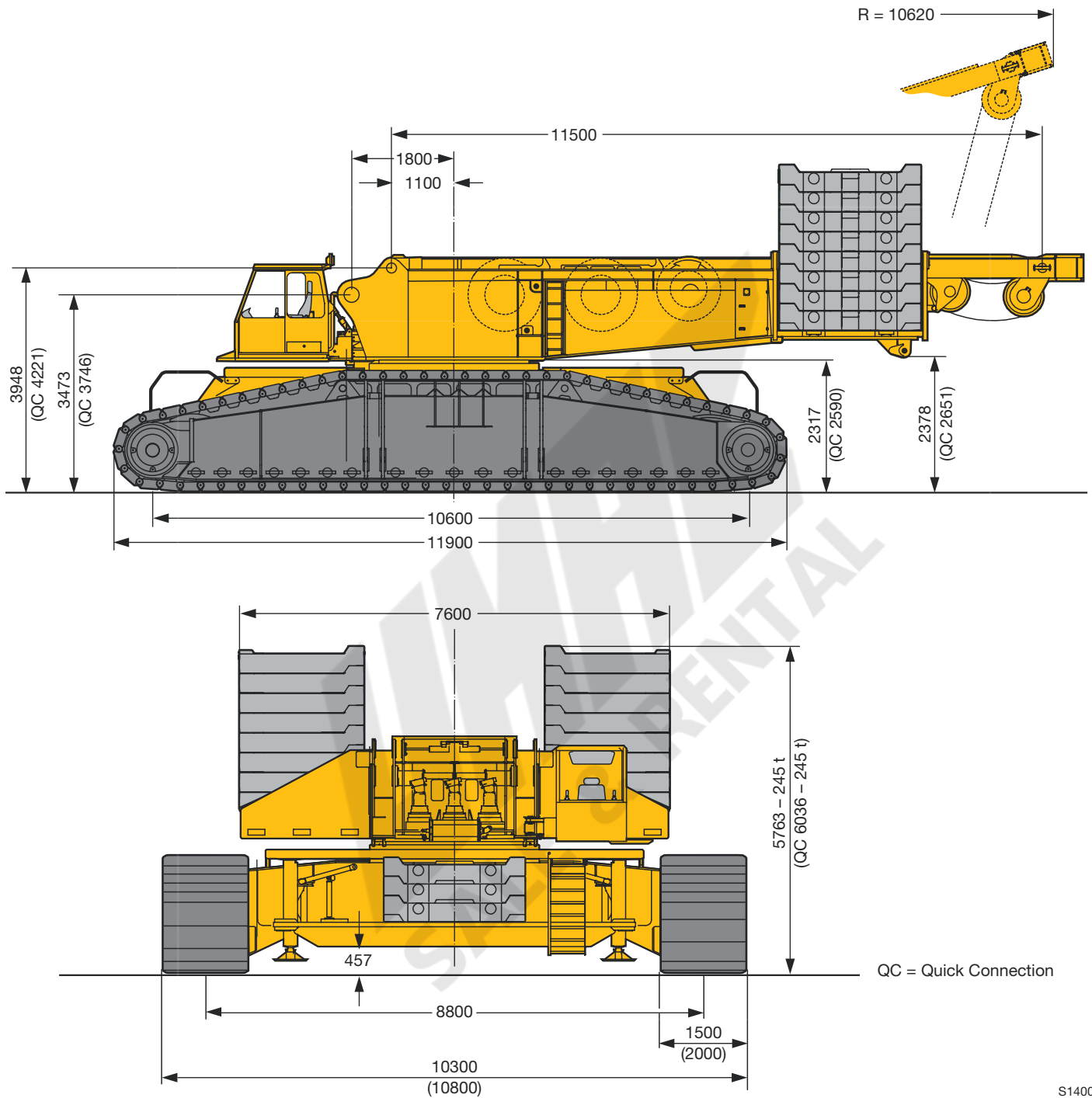

S1400

Maße
Dimensions
Encombrement

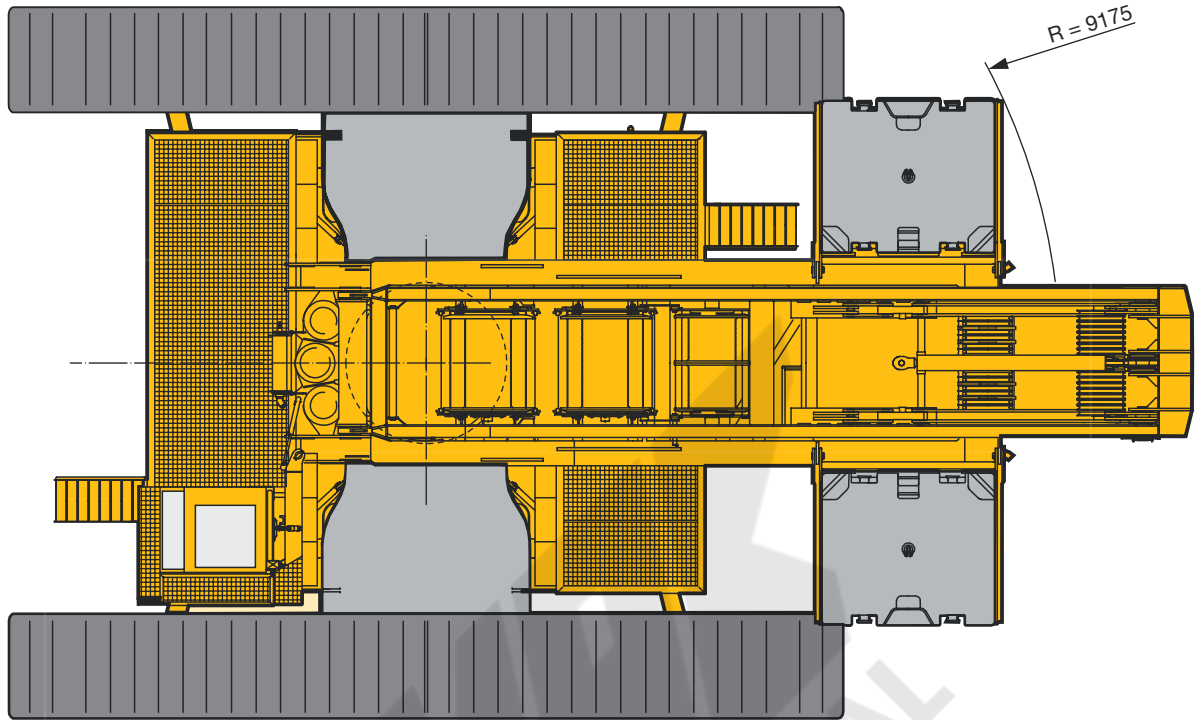

S1401

SALE & RENTAL

Maße Dimensions Encombrement

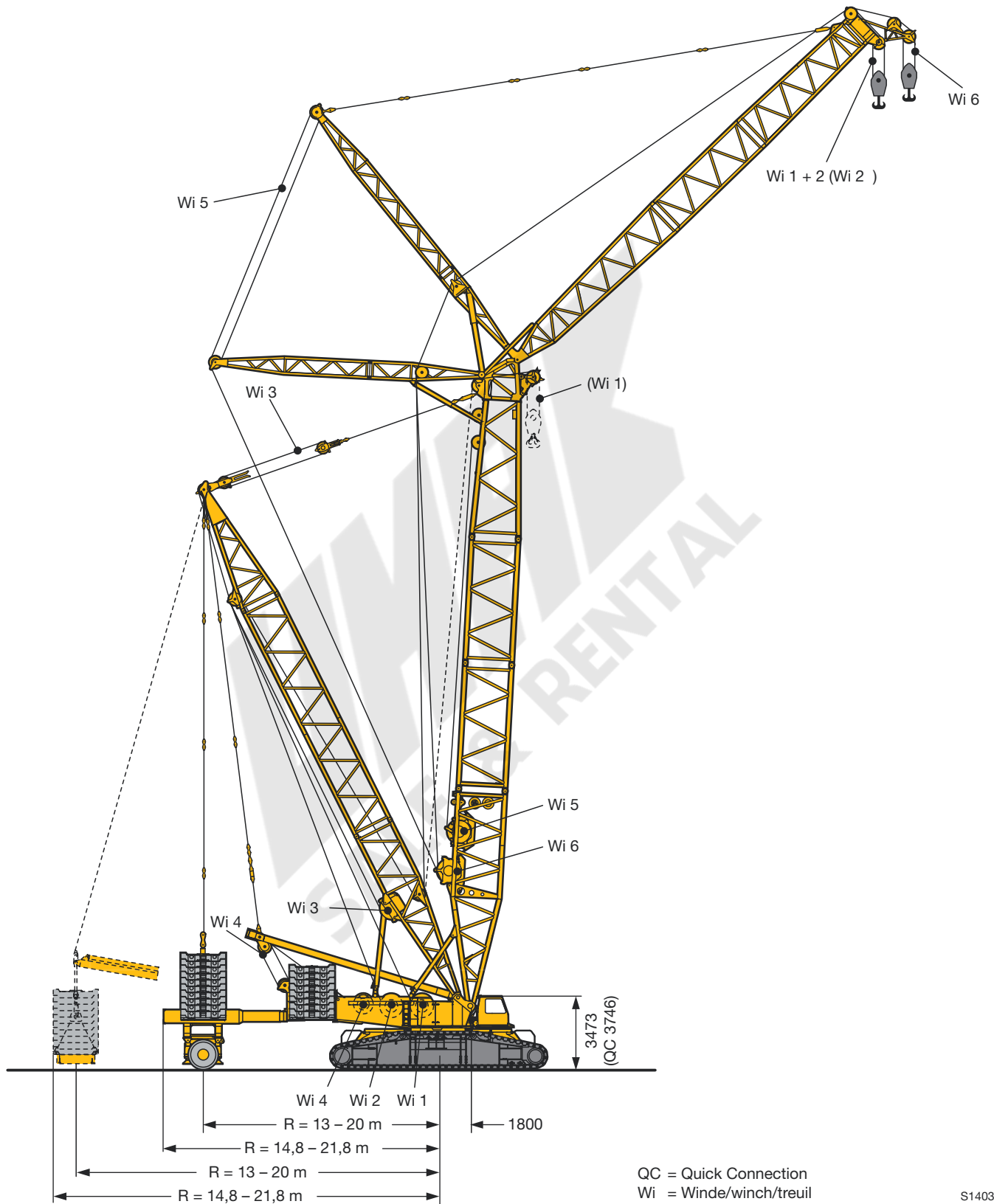

S1403

**Maße
Dimensions
Encombrement**

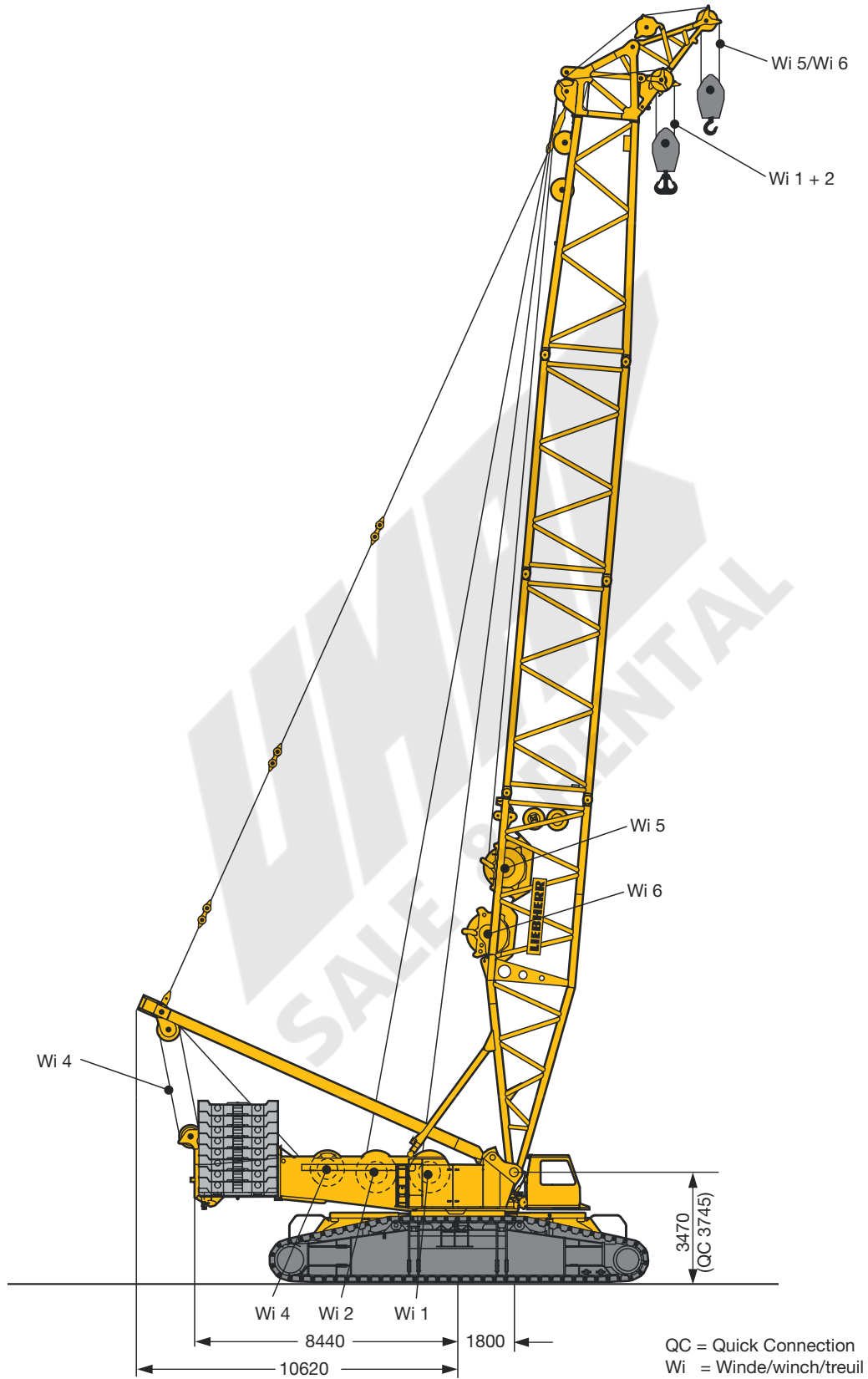

S1402

Geschwindigkeiten

Working speeds

Vitesses



	Gesamte Vortriebskraft mit einem Fahrtrieb pro Raupenträger Total driving force with one drive per crawler carrier Puissance propulsive totale avec un entraînement par porteur-chenille	2740 kN
	Gesamte Vortriebskraft mit zwei Fahrtrieben pro Raupenträger Total driving force with two drives per crawler carrier Puissance propulsive totale avec deux entraînements par porteur-chenille	5480 kN
	Gesamtgewicht mit Hauptausleger S 21 m, 170 t Gegengewicht, 45 t Zentralballast und 107 t Hakenflasche Total weight with main boom S 21 m, 170 t counterweight, 45 t central ballast and 107 t hook block Poids total avec flèche principale S 21 m, contrepoids de 170 t, lest central de 45 t et moufle de 107 t	420 t
	Mittlere Bodenpressung bei 420 t Gesamtgewicht und 1,5 m Bodenplatten Average ground pressure at 420 t total weight and 1.5 m track pads Pression moyenne au sol à 420 t de poids total et pains de chenille de 1,5 m	13 N/m ²
		0 – 1,65



Antriebe Drive Mécanismes	Zuordnung Mode Mode	Geschwindigkeiten Speeds Vitesses m/min	Max. Seilzug Max. single line pull Effort au brin maxi. kN	Seildurchmesser Rope diameter Diamètre du câble mm	Seillänge Rope length Longueur du câble m
	Hubwerk Hoist gear Mécanisme de levage	0 – 130	160	28	1250
	Hubwerk Hoist gear Mécanisme de levage	0 – 130	160	28	1250
	Verstellung Hauptausleger/D-Betrieb Derricking main boom/ D-operation Relevage mât principale/ en version D	0 – 130	160	28	1300
	Einziehwerk Derrick main boom Relevage mât principale	2 x 0 – 70	2 x 160	28	750
	Verstellung wippbare Gitterspitze Derricking luffing fly jib Relevage volée variable	0 – 130	160	28	1300
	Hubwerk/Mastnase Hoist gear/Whipline Mécanisme de levage/ Poulie brin simple	0 – 130	160	28	600
	0 – 87°	ca. 4 min. bei 49 m Auslegerlänge approx. 4 min. for boom length 49 m env. 4 min. pour longueur de flèche de 49 m			
		0 – 1,5 min ⁻¹			

Lastaufnahmemittel Hooks blocks and hooks Organes de préhension



Traglast (t) Load (t) Forces de levage (t)	Rollen No. of sheaves Poulies	Stränge No. of lines Brins	Gewicht (t) Weight (t) Poids (t)	Maß A (m) Dimension A (m) Dimension A (m)
600 / 312	2 x 11 / 1 x 11	2 x 22 / 1 x 23	11 - 16 / 8,4	5,3
400 / 215	2 x 7 / 1 x 15	2 x 14 / 1 x 15	7 - 15 / 5,5 - 7,5	4,6
107	3	7	2,5 - 5,5	4,5
47	1	3	1 - 3	4,2
16	-	1	1,1	3,2

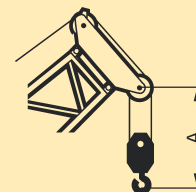

Einscherplan Reeving chart Tableau de mouflage

Stränge No. of lines Brins	1	2	3	4	5	6	7	8	9	10	11	12	13	14	15	16	17	18	19	20	21	22	23
Max. Traglast t Max. capacity t Capacité maxi. t	16	32	47	62	78	92	107	121	135	149	162	176	189	202	215	228	240	253	265	277	289	300	312
16 t																							
47 t																							
107 t																							
215 t																							
312 t																							

Stränge No. of lines Brins	2 x 4	2 x 5	2 x 6	2 x 7	2 x 8	2 x 9	2 x 10	2 x 11	2 x 12	2 x 13	2 x 14	2 x 15	2 x 16	2 x 17	2 x 18	2 x 19	2 x 20	2 x 21	2 x 22	
Max. Traglast t Max. capacity t Capacité maxi. t	124	156	184	214	242	270	298	324	352	378	404	430	456	480	506	530	554	578	600	
400 t																				
600 t																				

Transportplan Transportation plan Plan de transport

Drehbühne und Raupenmittelteil mit SA-Bock, Winde 4, Montageabstützung
Superstructure and crawler center section with SA-frame, with assembly jacks
Partie tourante et partie centrale du porteur avec chevalet SA, avec vérins de montage

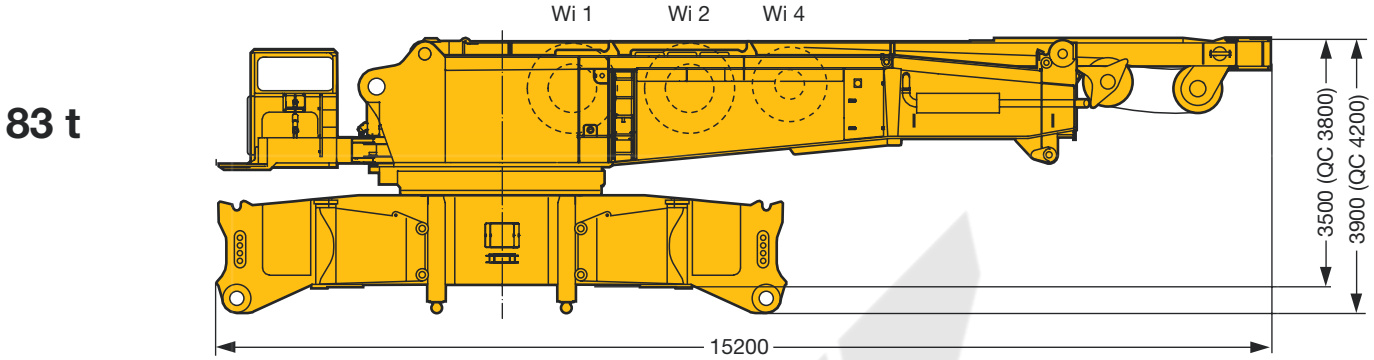

Drehbühne mit SA-Bock, Winde 4, Quick Connection, 2 Drehwerken
Superstructure with SA-frame, winch 4, quick connection, 2 slewing gears
Partie tourante avec chevalet SA, treuil 4, quick connection, 2 orientations

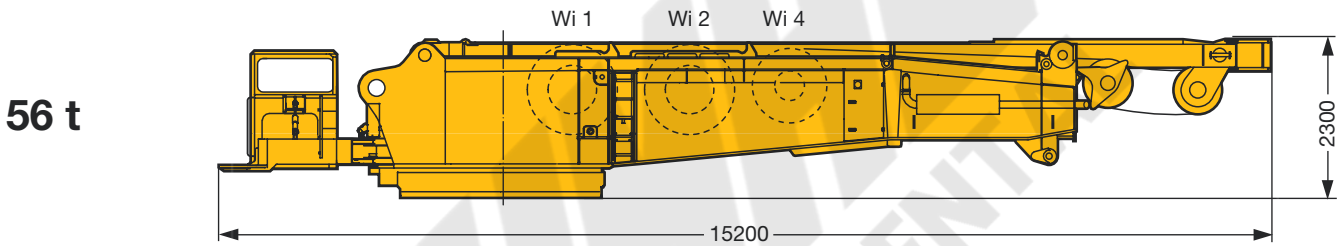

Raupenmittelteil mit hydr. Montageabstützung, Quick Connection
Crawler center section with assembly jacks, quick connection
Partie centrale du porteur avec éris de montage, quick connection

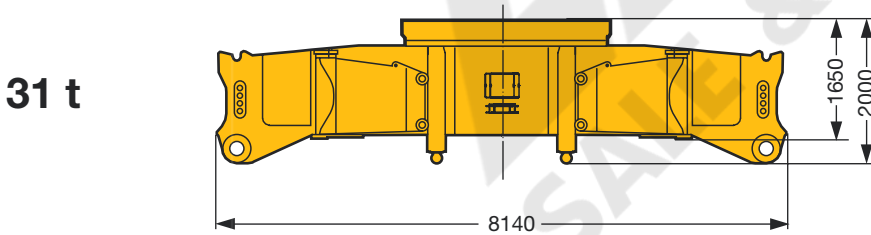

Raupenträger mit 1 (2) Fahrgetriebe
Crawler carrier with 1 (2) travelling gear
Porteur à chenilles avec 1 (2) trains de roulement

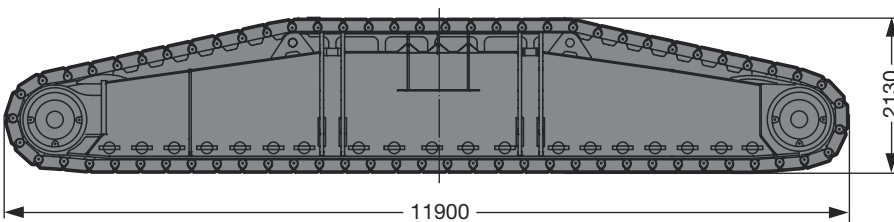

Bodenplatten
Track pads
Pains de chenille

1,5 m	2 m
42 t	51 t
(44 t)	(55 t)

QC = Quick Connection
Wi = Winde/winch/treuil

S1404

Transportplan Transportation plan Plan de transport

Drehbühne und Raupenmitteleil, Montageabstützung
Superstructure and crawler center section, assembly jacks
Partie tourante et partie centrale du porteur, vérins de montage

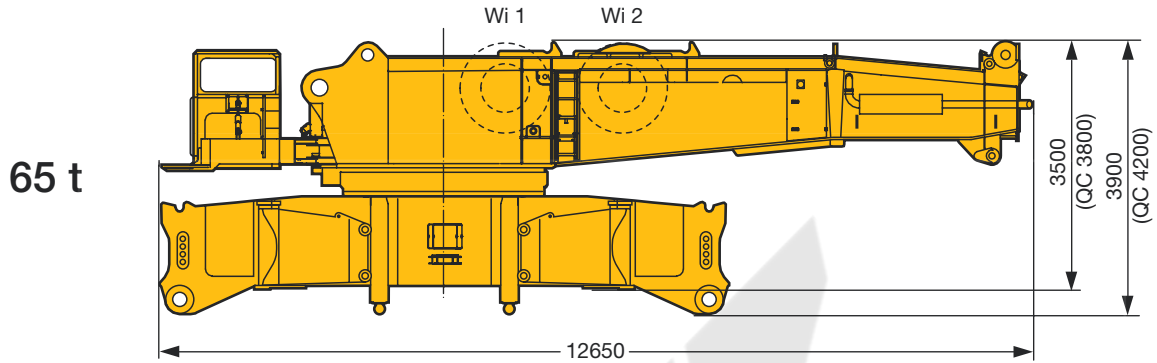

Drehbühne mit Quick Connection
Superstructure with quick connection
Partie tourante avec quick connection

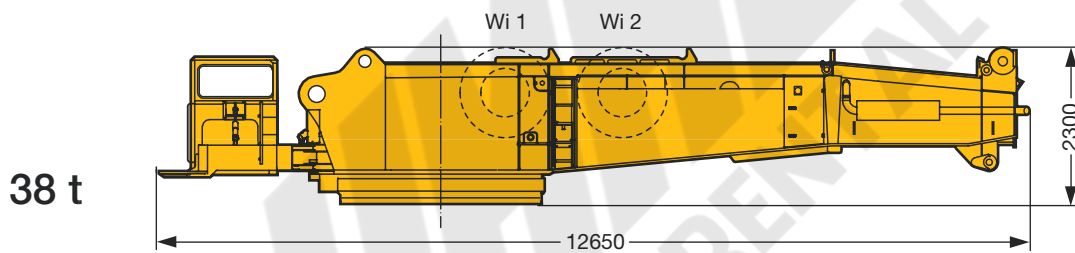

SA-Bock, Winde 4 inkl. Seil und Rollensatz
SA-frame, winch 4 incl. rope and pulley block
Chevalet SA, treuil 4 incl. câble et bloc de poulies

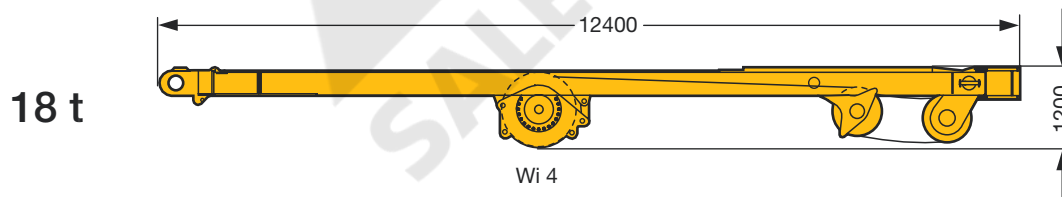

Winde 1 inkl. Seil
Winch 1 incl. rope
Treuil 1 incl. câble

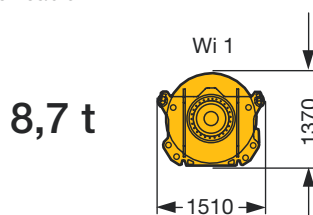

Winde 2 inkl. Seil
Winch 2 incl. rope
Treuil 2 incl. câble

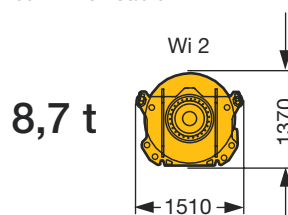

QC = Quick Connection
Wi = Winde/winch/treuil

S1405

Transportplan Transportation plan Plan de transport

Drehbühnenballast
CWT at superstructure
Contrepoids - tourelle

Zentralballast
Central CWT
Lest central

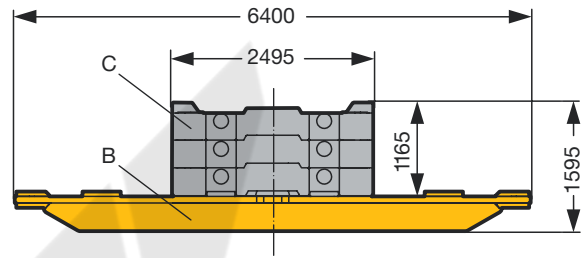
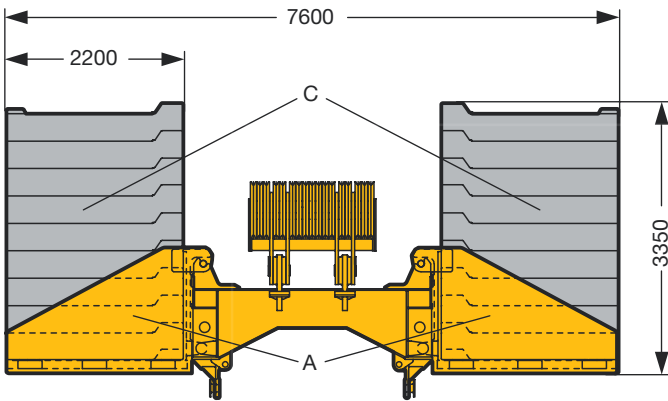

Teil A, Part A

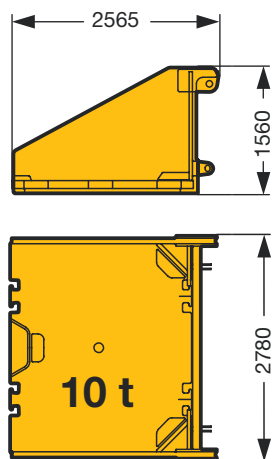

Teil C, Part C

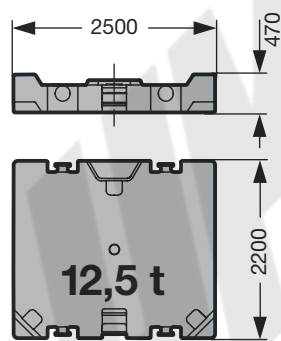

Teil B, Part B

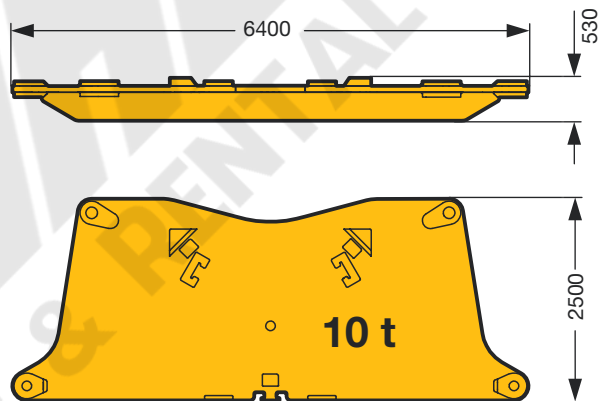

	Teil A / Part A à 10 t	Teil A / Part A à 12,5 t
170 t	2 x	12 x
220 t	2 x	16 x
245 t	2 x	18 x

	Teil B / Part B à 10 t	Teil B / Part B à 12,5 t
45 t	2 x	2 x
95 t	2 x	6 x

Transportplan Transportation plan Plan de transport

Ausleger-Zwischenstücke Boom intermediate sections Eléments de flèches intermédiaires	B x H	Grundlänge Base length Longueur de base	Transportlänge Transport length Longueur de transport	Gewicht* Weight* Poids*
S 2826.20	3 m x 3 m	7 m	7,4 m	6,7 t
		14 m	14,4 m	12,4 t
LA 2826.10	3 m x 3 m	7 m	7,4 m	4,5 t
		14 m	14,4 m	8,1 t
LI 2421.10	2,6 m x 2,4 m	7 m	7,4 m	3,7 t
		14 m	14,4 m	6,8 t
LI 2421.8	2,6 m x 2,4 m	7 m	7,4 m	3,0 t
		14 m	14,4 m	5,6 t
D 2421.10	2,6 m x 2,4 m	14 m	14,4 m	8,5 t

* Gewichte inkl. Abspannstangen und Bolzen / Weights incl. guy rods and bolts / Poids avec barres de haubanage et boulons

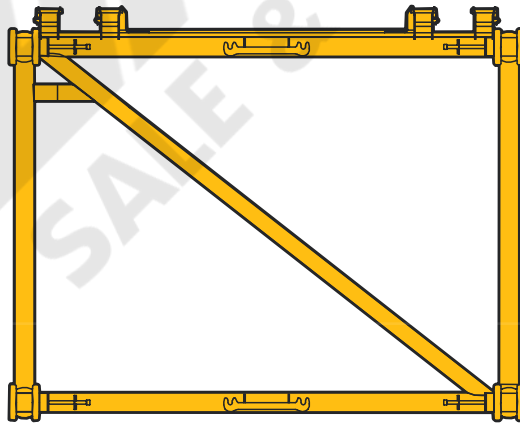

Auslegersysteme Boom/jib combinations Configurations de flèche

- S** Hauptausleger, schwer
Main boom, heavy
Flèche principale, lourde
- SL** Hauptausleger, schwer/leicht
Main boom, heavy/light
Flèche principale, lourde/légère
- W** Wippbare Gitterspitze, schwer
Luffing fly jib, heavy
Flèchette, lourde

- D** Derricksausleger
Derrick
Flèche derrick
- B** Schwebeballast
Suspended ballast
Lest suspendu
- BW** Ballastwagen
Ballast trailer
Porteur de lest



Auslegersysteme Boom/jib combinations Configurations de flèche

- S - System 2826.20
- LA - System 2826.10
- LI - System 2421.10
- LI - System 2421.8
- D - System 2421.10

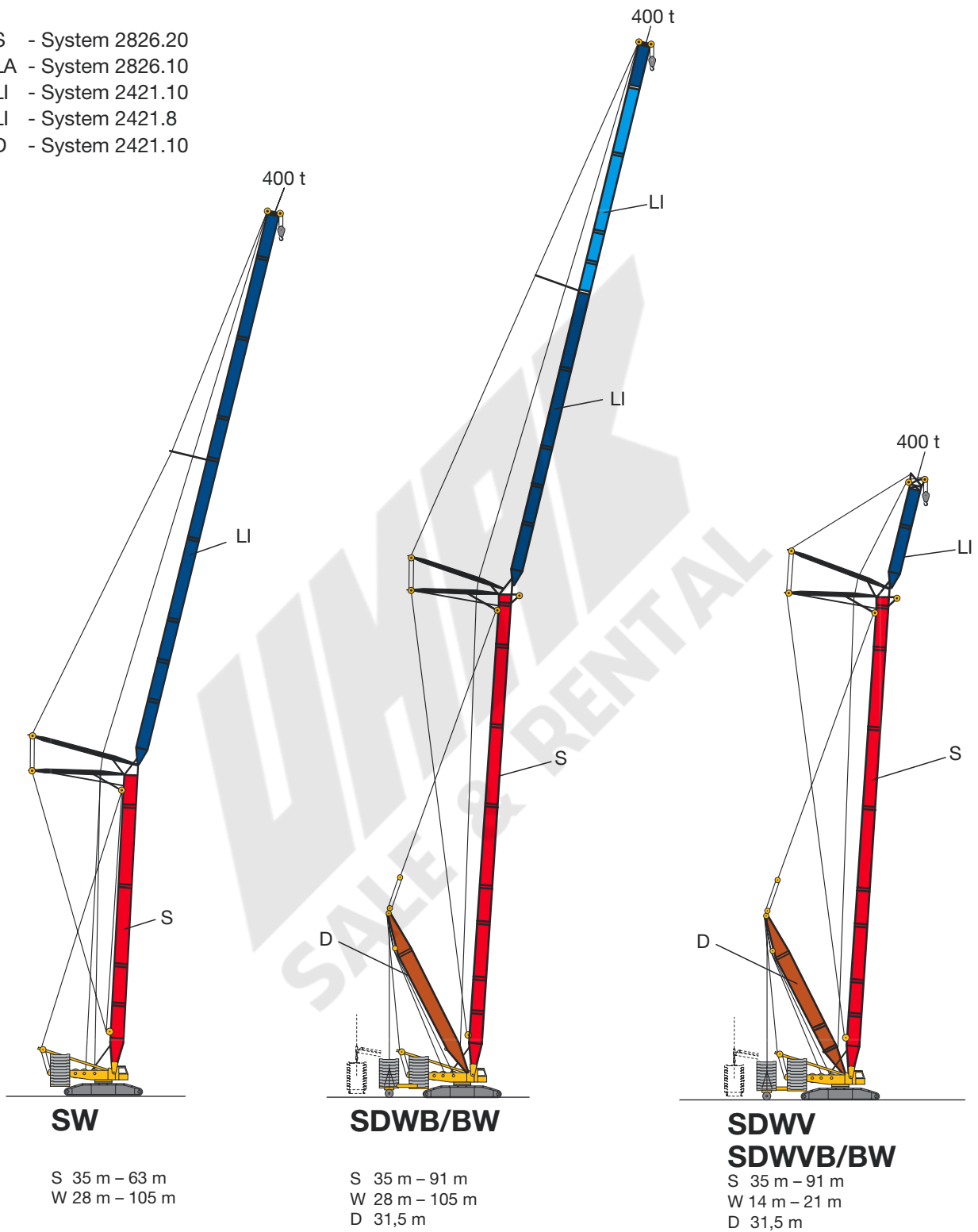

Traglasten am SL-Ausleger

Lifting capacities on SL boom

Forces de levage à la flèche principale SL

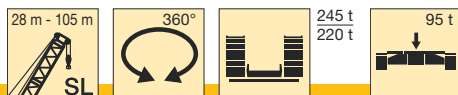

	28 m	35 m	42 m	49 m	56 m	63 m	70 m	77 m	84 m	91 m	98 m	105 m	
6	400												6
6,5	400												6,5
7	400	400											7
8	400	400	400	400									8
9	400	400	400	400	385	366							9
10	400	400	394	390	371	349	329	285					10
11	376	374	373	356	336	316	299	280	270				11
12	345	343	342	323	306	289	274	261	248	214	202		12
14	292	291	288	272	258	246	234	224	213	205	195	161	14
16	252	250	247	234	223	212	203	195	186	179	170	157	16
18	216	216	215	205	195	186	178	172	164	158	151	147	18
20	186	185	185	181	173	166	158	153	146	141	134	131	20
22	163	162	162	160	155	148	142	137	131	127	120	118	22
24	145	144	143	142	140	134	128	124	118	115	109	106	24
26	130	129	128	126	125	122	116	112	107	104	99	96	26
28		116	116	114	113	111	106	102	98	95	90	88	28
30		106	105	103	102	100	97	94	89	87	82	80	30
32		97	96	94	93	91	90	86	82	80	75	73	32
34			88	87	85	83	82	80	75	73	69	67	34
36			82	80	78	77	75	74	70	67	63	62	36
38			76	74	72	71	69	68	64	62	58	57	38
40			71	69	67	65	64	63	60	58	54	52	40
44				60	58	56	55	54	51	49,5	45,5	44,5	44
48					51	49	47,5	46,5	44,5	43	39	38	48
52					45	43	41,5	40	38,5	37	33,5	32,5	52
56						38	36	35	33	32	28,5	27,6	56
60							32	30,5	28,2	27,6	24,3	23,4	60
64							28	26,6	24,2	23,6	20,7	19,7	64
68								23,2	20,7	20	17,4	16,4	68
72								20,3	17,7	17	14,5	13,5	72
76									15,2	14,3	11,8	10,5	76
80										11,9	9,1	7,4	80
84											6,8	5,6	84
88											5,4	4	88

TAB 128042 / 128043

Anmerkungen zu den Traglasttabellen

- Für die Kranberechnungen gelten die DINVorschriften lt. Gesetz gemäß Bundesarbeitsblatt von 2/85: Die Traglasten DIN/ISO entsprechen den geforderten Standsicherheiten nach DIN 15019, Teil 2 und ISO 4305 (Prüflast = 1,25 x Hublast + 0,1 x Auslegereigengewicht auf die Ausleger- spitze reduziert). Für die Stahltragwerke gilt DIN 15018, Teil 3. Die bauliche Ausbildung des Krans entspricht DIN 15018, Teil 2 sowie der F.E.M.
- Die Traglasten sind in Tonnen angegeben.
- Das Gewicht des Lasthakens bzw. der Hakenflasche sowie der Anschlagmittel ist von den Traglasten abzuziehen.
- Die Ausladungen sind von Mitte Drehkranz gemessen.
- Kranbetrieb – wenn nicht speziell dokumentiert – zulässig bis: Staudruck 50 N/m², Windgeschwindigkeit 9 m/s. Weitere Angaben über Windgeschwindigkeiten sind der Bedienungsanleitung zu entnehmen.
- Die Aufstandsfläche muß eben und tragfähig sein.
- Traglaständerungen vorbehalten.
- Der Kran kann mit den in den Traglasttabellen angegebenen Lasten verfahren. Die Betriebsbedingungen sind der Bedienungsanleitung zu entnehmen.

Remarques relatives aux tableaux des charges

- When calculating crane stresses and loads, German Industrial Standards (DIN) are applicable, in conformance with new German legislation (published 2/85). The lifting capacities (stability margin) DIN/ISO correspond to DIN 15019, part 2, and ISO 4305 (Tested load = 1.25 x lifting capacity + 0.1 x boom dead weight, reduced to the boom point). The crane's structural steel work is in accordance with DIN 15018, part 3. Design and construction of the crane comply with DIN 15018, part 2 and with F.E.M. regulations.
- Lifting capacities are given in metric tons.
- The weight of the load hook and hook blocks as well as of the lifting tackle must be deducted from the lifting capacities.
- The working radii are measured from the slewing centreline.
- Unless particularly specified, crane operation is permissible up to a dynamic pressure of 50 N/m², wind speed of 9 m/s. For further details in respect to wind speeds refer to the operating instructions.
- The subsoil must be even and of good bearing capacity.
- Subject to modification of lifting capacities.
- The crane can be displaced with suspended loads as stated in the load charts. Operating conditions must conform to the rules in the operating instructions.2

Hubhöhen am SL-Ausleger
Lifting heights on SL boom
Hauteur de levage à la flèche principale SL

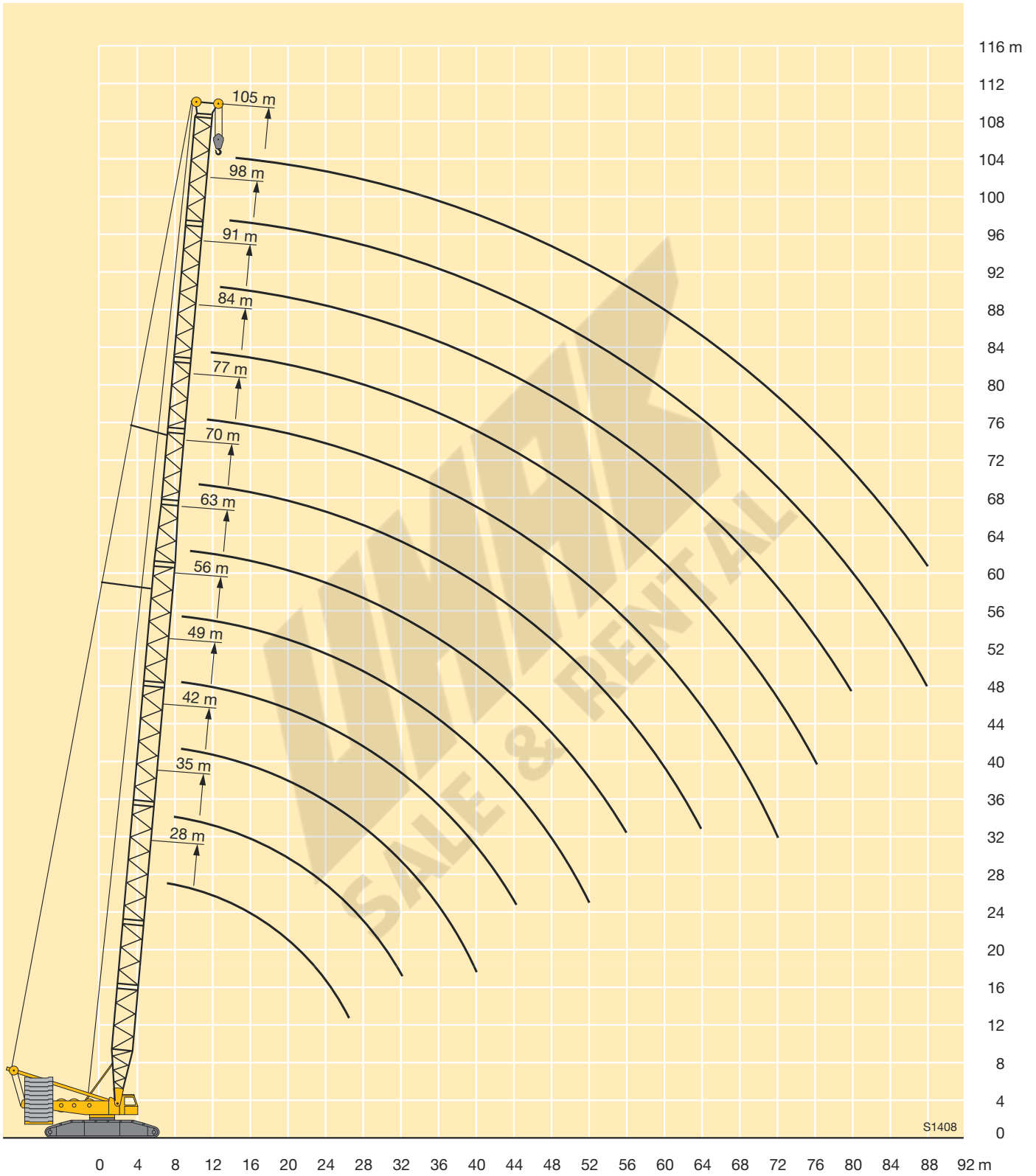

Traglasten am SLD-Auslegersystem

Lifting capacities on SLD boom/derrick combination

Forces de levage en configuration SLD

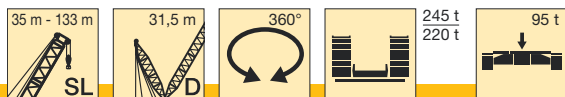

	35 m	42 m	49 m	56 m	63 m	70 m	77 m	84 m	91 m	98 m	105 m	112 m	119 m	126 m	133 m	
8			329													8
9		325	325	321												9
10	330	321	322	319	321	332										10
11	325	317	319	317	304	309	294	278								11
12	321	314	312	294	296	283	270	255	245	222						12
14	279	262	256	260	254	241	231	219	212	202	181	162	132			14
16	227	221	220	214	211	209	201	191	186	176	171	161	131	118	100	16
18	195	192	189	187	183	178	177	168	164	156	152	144	130	118	100	18
20	174	170	165	163	159	156	154	150	146	139	135	129	125	117	100	20
22	155	151	147	143	141	137	137	134	132	125	122	116	112	108	100	22
24	137	133	131	128	125	123	121	118	119	113	110	104	101	97	93	24
26	123	121	120	116	114	110	109	105	106	102	100	95	92	88	84	26
28	115	110	109	107	105	100	98	95	95	92	91	86	84	80	76	28
30	107	100	100	99	97	93	89	86	86	82	83	78	76	73	70	30
32	99	94	91	91	90	86	83	77	78	76	75	71	70	66	63	32
34		89	83	83	83	79	77	72	72	70	67	64	63	61	58	34
36		83	78	76	76	73	71	67	67	65	61	57	57	55	53	36
38		78	73	69	70	68	66	62	61	60	56	52	52	49,5	48	38
40		73	69	64	64	62	61	58	57	55	51	47,5	46	44,5	43	40
44			62	58	53	52	52	49,5	47,5	45,5	43	39	38	35,5	34	44
48				52	47,5	43	44	41,5	38,5	37	37	33,5	30	27,7	25,2	48
52				46	42,5	38,5	36	34,5	32,5	28,9	30,5	28,1	24,6	20,6	19,5	52
56					38	34,5	32	27,3	27,3	24	25,1	23,4	20,4	17,4	14,7	56
60						30,5	28,2	23,4	22,3	19,4	19,8	19	16,5	14,7	10,1	60
64						26,8	24,9	20,6	19	15,1	14,8	14,8	12,8	12,1	6,4	64
68							21,8	17,9	16,6	12,3	11,5	10,9	9,4	9,8	5,4	68
72							18,8	15,4	14,4	10,6	9,9	7,1	6,2	7,5	4,4	72
76								13	12,3	9	8,4	4,3	4	5,1		76
80									10,2	7,5	7	3,6	3,4			80
84										6,1	5,7					84
88										4,7	4,4					88

* nur aufrichtbar mit Derrickballast / raisable only with derrick ballast / seulement relevable avec contrepoids derrick

TAB 128028 / 128029

Remarques relatives aux tableaux des charges

1. La grue est calculée selon normes DIN conformément au décret fédéral 2/85. Les charges DIN/ISO respectent les sécurités au basculement requises par les normes DIN 15019, partie 2 et ISO 4305. La structure de la grue est conçue selon la norme DIN 15018, partie 3. La conception générale est réalisée selon la norme DIN 15018, partie 2, ainsi que selon les recommandations de la F.E.M.
2. Les charges sont indiquées en tonnes.
3. Les poids du crochet ou du moufle ainsi que des élingues sont à déduire des charges indiquées.
4. Les portées sont prises à partir de l'axe de rotation de la partie tournante.
5. Sinon spécifié autrement, le service de grue est admissible jusqu'à une pression dynamique de 50 N/m², vitesse de vent de 9 m/s. D'autres indications concernant les vitesses de vent sont stipulées dans les instructions de service.
6. Le sol doit être plat et résistant.
7. Charges données sous réserve de modification.
8. La grue peut être déplacée avec les charges indiquées dans les tableaux des charges. Les conditions de service sont stipulées dans les instructions de service.

Hubhöhen am SLD-Auslegersystem
Lifting heights on SLD boom/derrick combination
Hauteur de levage en configuration SLD

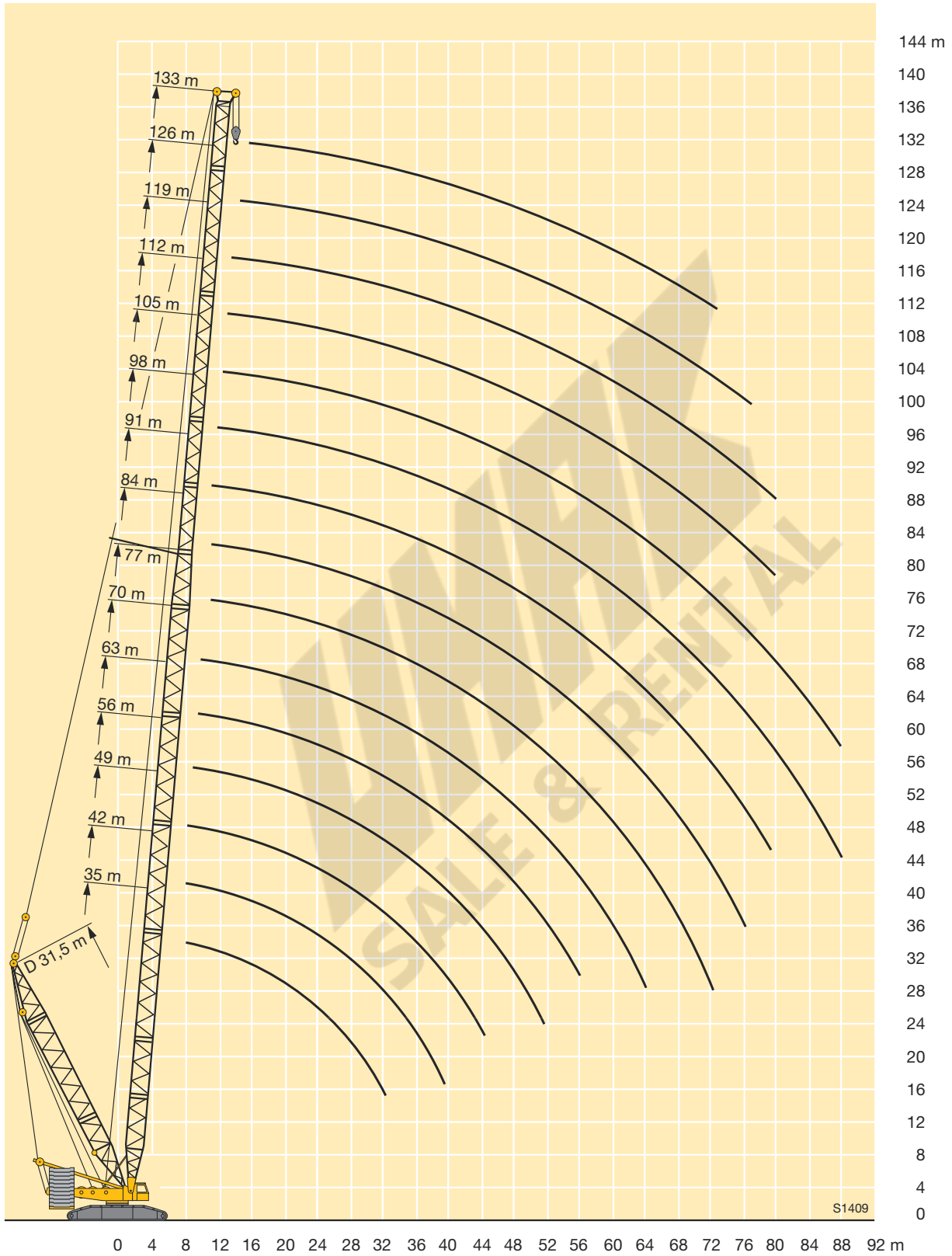

Traglasten am SLDB/BW-Auslegersystem

Lifting capacities on SLDB/BW boom/derrick combination

Forces de levage en configuration SLDB/BW

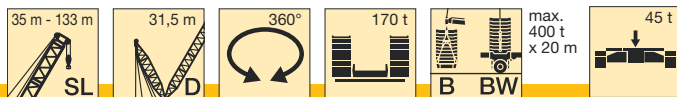

	35 m	42 m	49 m	56 m	63 m	70 m	77 m	84 m	91 m	98 m	105 m	112 m	119 m	126 m	133 m	
7	400															7
8	400	400	400													8
9	400	400	400	400												9
10	400	400	400	400	393	371										10
11	400	400	400	400	392	370	328	301								11
12	400	400	400	400	391	370	328	301	245	222						12
14	400	400	400	400	388	368	327	301	244	221	181	162	132			14
16	400	400	400	398	387	367	326	300	243	218	179	161	131	118	100	16
18	400	400	400	396	385	366	326	299	242	216	178	160	130	118	100	18
20	400	400	400	394	384	365	325	289	239	214	176	159	129	117	100	20
22	395	400	395	381	373	361	322	279	230	213	175	158	129	116	100	22
24	357	362	361	357	348	339	311	269	222	207	174	157	128	115	99	24
26	321	335	334	333	328	322	300	260	215	201	172	157	127	115	99	26
28	286	310	309	301	307	306	290	252	208	196	170	156	127	114	98	28
30	254	290	289	288	287	286	280	245	202	191	165	154	126	113	98	30
32	225	267	270	269	268	267	266	237	196	186	160	150	126	113	96	32
34		242	255	254	253	253	253	230	191	182	156	146	125	112	94	34
36		219	242	240	238	236	236	222	186	178	151	142	122	112	92	36
38		198	224	225	223	221	221	213	181	174	147	139	120	110	90	38
40		177	207	212	209	207	207	204	176	170	144	135	117	108	88	40
44			174	189	186	184	184	181	167	162	136	129	113	104	84	44
48				165	168	165	164	162	159	155	130	124	108	100	81	48
52				141	152	149	148	145	146	143	124	119	104	97	77	52
56					134	136	135	132	132	130	118	113	99	93	75	56
60						124	123	120	120	118	113	109	95	90	71	60
64						110	113	110	109	107	107	104	91	86	68	64
68							104	101	101	97	98	95	87	83	65	68
72							93	93	93	90	89	87	83	80	63	72
76								86	86	83	83	79	79	77	60	76
80									78	77	77	74	73	71	58	80
84										71	71	68	67	66	55	84
88										65	66	63	62	60	53	88
92											60	58	57	56	51	92
96											55	54	53	51	49	96
100												49	49	47	45,5	100
104													45,5	43,5	41,5	104
108													41	40	38,5	108
112														36,5	35	112
116															30	116
120															26	120

TAB 128077 / 128076

Hubhöhen am SLDB/BW-Auslegersystem
Lifting heights on SLDB/BW boom/derrick combination
Hauteur de levage en configuration SLDB/BW

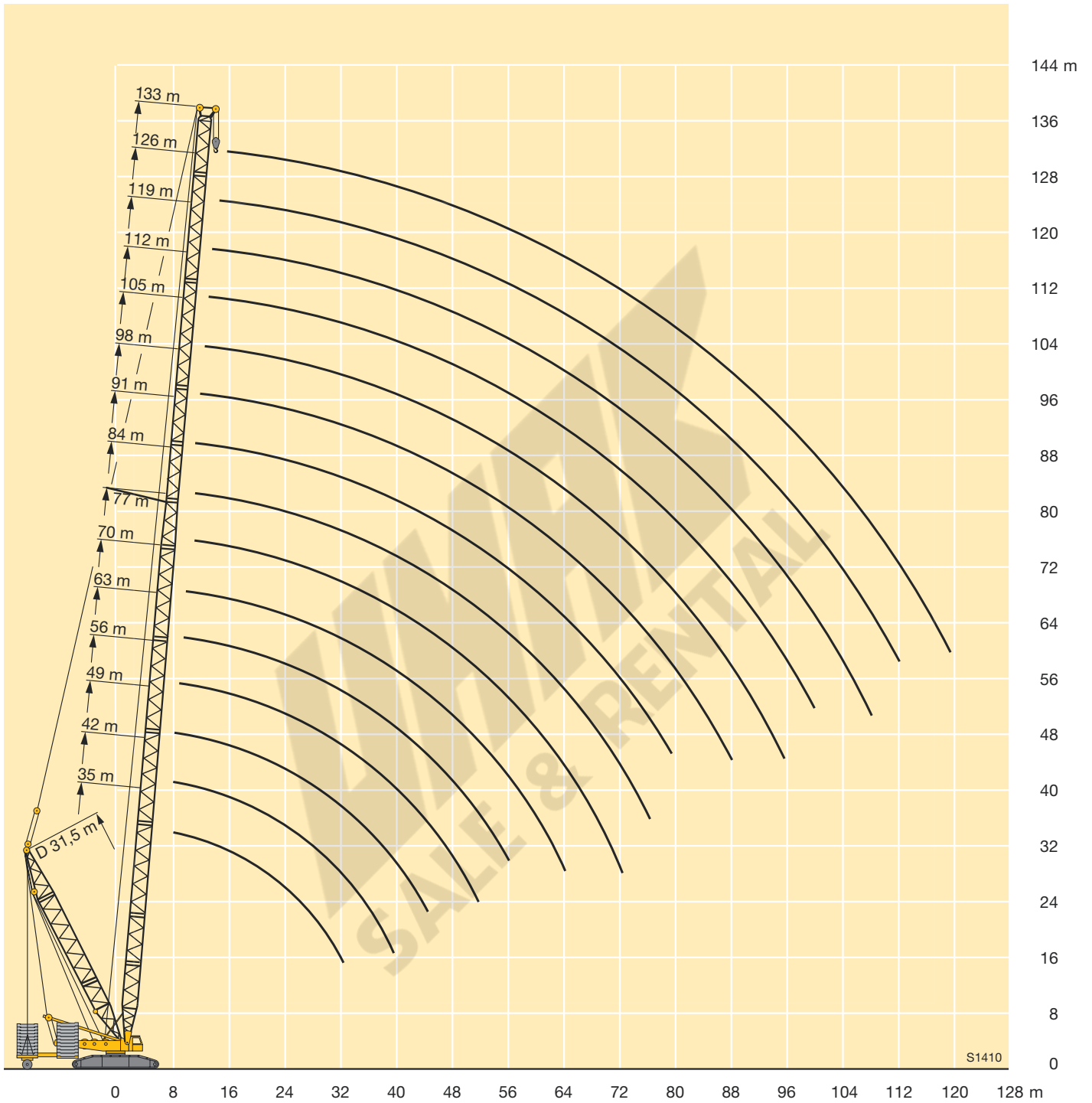

Traglasten am S-Ausleger

Lifting capacities on S boom

Forces de levage à la flèche principale S

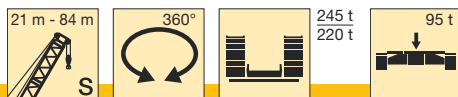

	21 m	28 m	35 m	42 m	49 m	56 m	63 m	70 m	77 m	84 m	
6	600										6
6,5	600	600									6,5
7	576	574	570								7
8	507	505	505	503	496						8
9	442	453	450	448	434	403					9
10	399	408	405	403	385	360	339	319			10
11	373	371	368	366	346	324	306	289	274	261	11
12	342	340	337	334	313	294	279	264	251	239	12
14	289	287	285	278	261	247	235	223	213	204	14
16	248	246	244	237	223	212	202	192	184	176	16
18	212	211	210	205	194	184	176	168	161	154	18
20	181	181	180	178	171	162	155	148	142	136	20
22		158	156	155	152	144	138	132	126	121	22
24		140	138	136	134	129	123	118	113	108	24
26		125	123	121	119	116	111	106	102	97	26
28			111	109	107	105	101	96	92	88	28
30			100	98	96	94	92	87	83	79	30
32			91	89	87	85	84	79	76	72	32
34				82	79	77	76	72	69	65	34
36				75	73	71	69	66	63	60	36
38				69	67	65	63	61	58	54	38
40				64	62	59	58	56	53	49,5	40
44					53	51	49	47	44,5	41,5	44
48						44	41,5	39,5	37,5	34,5	48
52						38	35,5	33,5	31,5	28,6	52
56							30,5	28	26	23,7	56
60								23,6	21,4	19,4	60
64								19,9	17,5	15,5	64
68									14,2	12,1	68
72									11,5	9,1	72
76										6,6	76

TAB 128036 / 128037

Hubhöhen am S-Ausleger
Lifting heights on S boom
Hauteur de levage à la flèche principale S

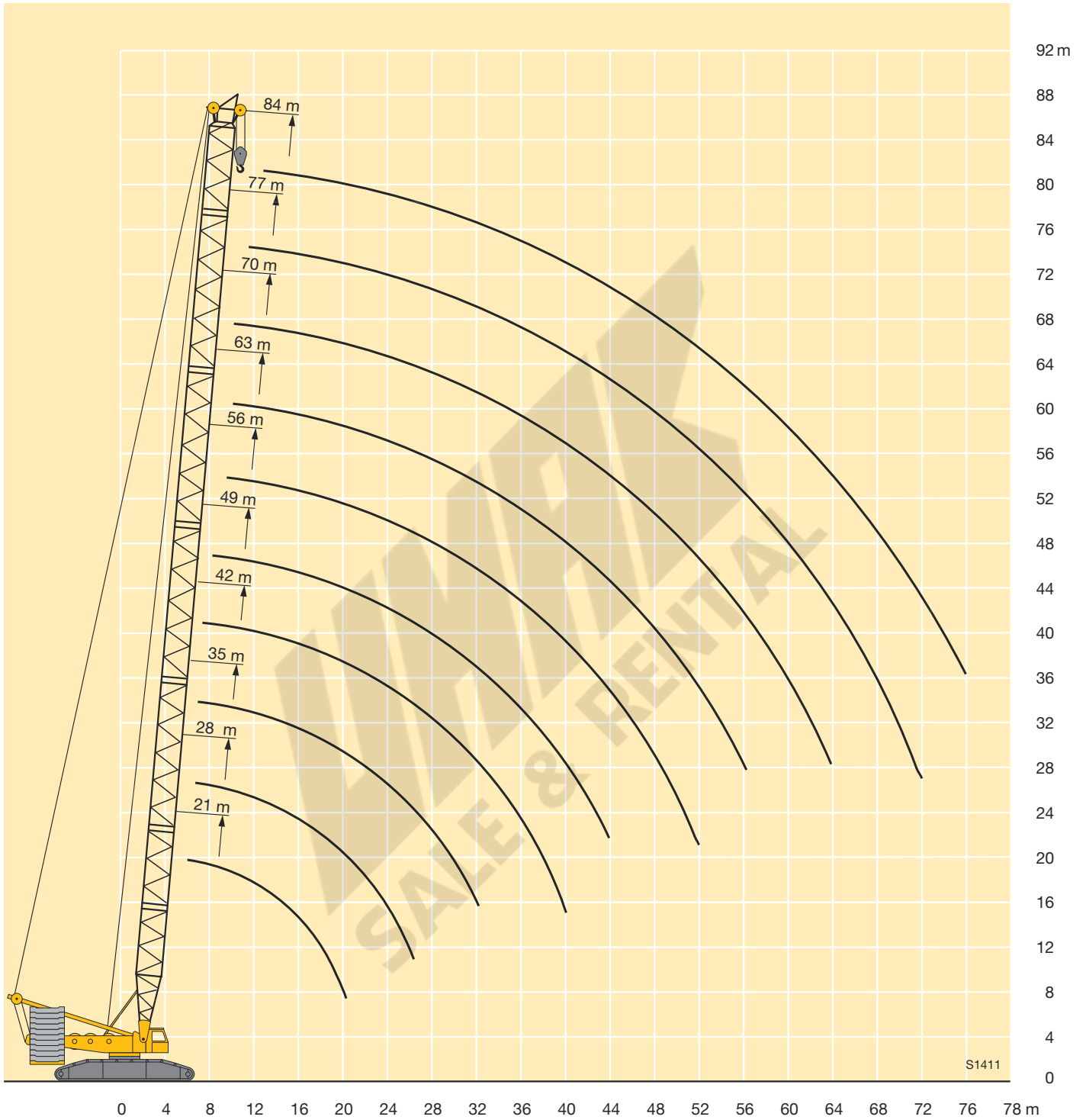

Traglasten am SD-Auslegersystem

Lifting capacities on SD boom/derrick combination

Forces de levage en configuration SD

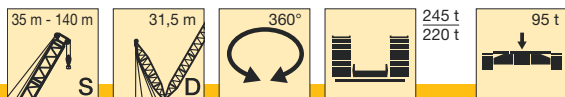

	35 m	42 m	49 m	56 m	63 m	70 m	77 m	84 m	91 m	98 m	105 m	112 m	119 m	126 m	133 m	140 m	
7	440																7
8	439	428	422														8
9	431	422	417	391													9
10	399	396	386	376	353	332											10
11	362	370	360	339	319	301	285	269									11
12	341	339	326	307	290	275	261	247	235	224							12
14	286	283	272	259	245	233	222	211	201	192	185	178	167				14
16	241	238	233	222	211	201	192	182	174	167	161	155	149	143	124	105	16
18	209	206	202	193	184	176	168	160	153	147	142	137	131	126	121	105	18
20	182	180	177	170	162	155	148	141	135	130	125	121	117	112	107	104	20
22	160	157	155	152	144	138	132	125	120	115	112	108	104	99	96	93	22
24	143	140	137	134	130	124	118	112	107	103	100	97	93	89	85	83	24
26	129	127	124	122	116	112	106	101	96	92	90	87	83	80	76	74	26
28	117	115	112	111	106	101	96	91	87	83	81	78	75	71	69	66	28
30	106	103	101	100	97	92	87	83	79	75	73	70	68	64	62	60	30
32	97	95	92	91	88	84	79	75	71	68	66	64	61	58	55	53	32
34		87	83	82	81	77	72	68	65	62	60	58	55	52	49,5	48	34
36		80	77	75	73	71	66	62	59	56	54	52	49,5	47	44,5	43	36
38		74	71	68	67	65	59	57	53	51	49	47	45	42	40	38,5	38
40		69	66	61	60	60	53	52	48	46	44,5	42,5	40,5	38	35,5	34,5	40
44			57	54	48	49,5	44,5	43	40	38	36	34,5	32	30	28,2	26,4	44
48				47,5	42,5	38,5	36,5	35	32,5	31	26,8	25,6	23,2	23	21,2	17,6	48
52				41,5	37,5	33	29,2	27,7	25,9	25,1	21,2	18,1	16,5	16,3	14,8	10,3	52
56					32,5	28,5	24,5	20,8	19,7	19,5	16,5	14,6	13,4	10,1	8,8	8	56
60						24,5	21	16,5	13,8	14,2	12,2	11,3	10,5	7,1	5,1	5,4	60
64						20,8	17,7	13,9	9,8	9,3	8,2	8,3	7	5,2			64
68							14,6	11,4	7,8	5,6		5,4					68
72							11,7	9,1	6								72
76								6,9									76

* nur aufrichtbar mit Derrickballast / raisable only with derrick ballast / seurement relevable avec contrepoids derrick

TAB 128022 / 128023

SALE & RENTAL

Hubhöhen am SD-Auslegersystem
Lifting heights on SD boom/derrick combination
Hauteur de levage en configuration SD

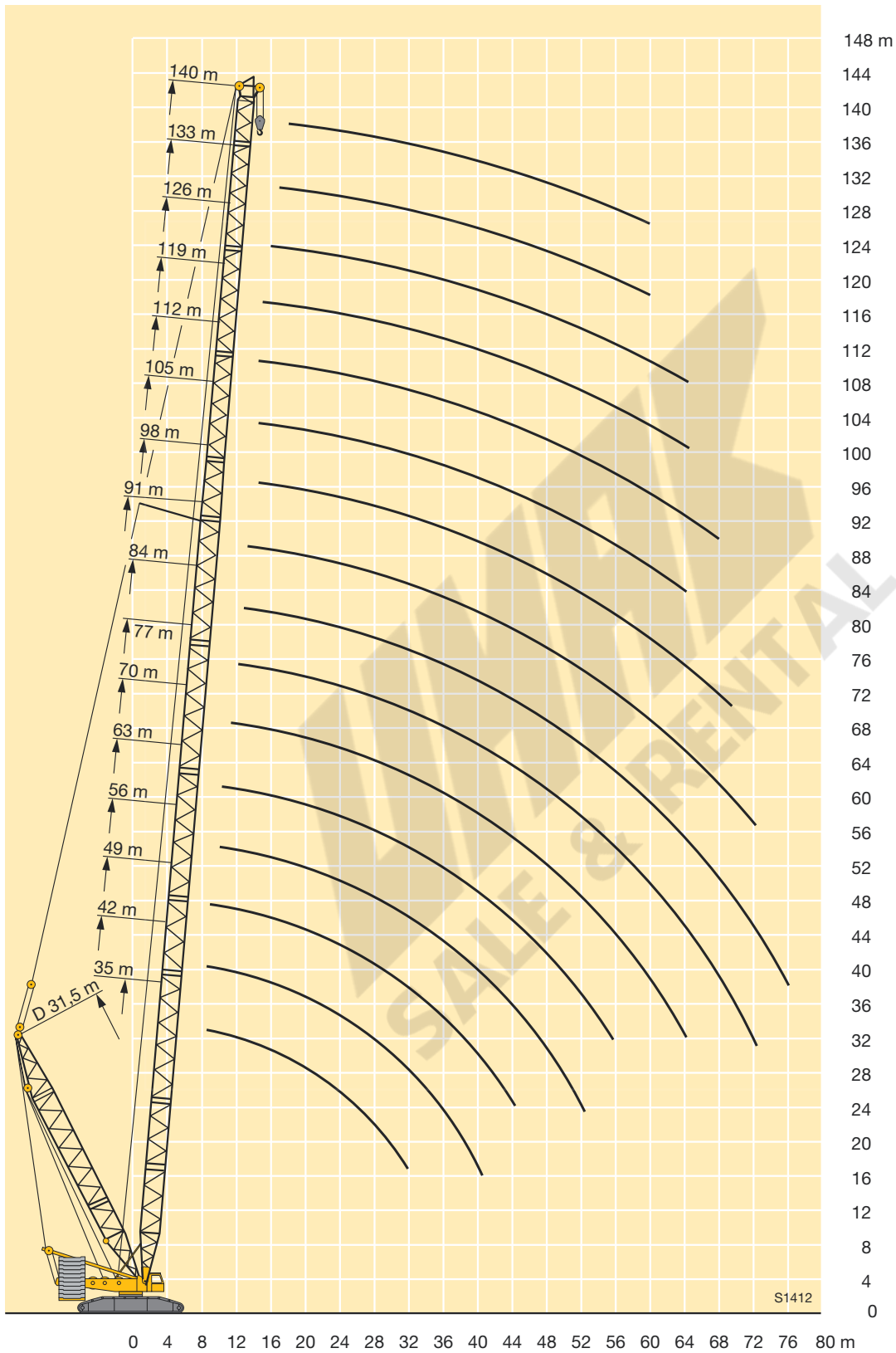

Traglasten am SDB/BW-Auslegersystem

Lifting capacities on SDB/BW boom/derrick combination

Forces de levage en configuration SDB/BW

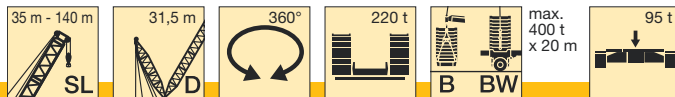

	35 m	42 m	49 m	56 m	63 m	70 m	77 m	84 m	91 m	98 m	105 m	112 m	119 m	126 m	133 m	140 m	
7	750																7
8	750	731	713														8
9	715	701	684	665													9
10	687	674	657	643	559	474											10
11	659	649	634	620	558	473	404	346									11
12	635	624	612	581	555	472	403	346	298	258							12
14	576	567	554	537	512	470	402	345	297	257	221	192	167				14
16	541	531	518	499	473	445	401	344	297	256	220	192	167	144	124	105	16
18	512	496	483	464	439	415	387	343	296	256	219	191	166	143	123	105	18
20	458	466	450	432	410	388	364	341	295	255	217	191	166	143	123	104	20
22	402	434	420	403	383	364	342	327	293	254	215	191	165	143	123	104	22
24	357	391	394	377	359	341	323	310	284	252	214	191	165	142	122	103	24
26	315	354	365	357	339	324	305	294	274	247	213	190	164	142	122	103	26
28	281	319	335	336	322	308	288	279	264	239	211	190	164	142	122	102	28
30	249	286	307	311	302	293	274	262	249	232	208	190	164	141	122	102	30
32	220	259	280	288	282	277	258	246	234	223	203	188	163	141	121	101	32
34		235	255	266	264	260	242	231	221	211	197	187	161	140	119	101	34
36		212	234	246	246	244	228	217	208	200	189	185	158	139	117	100	36
38		191	216	226	230	230	213	205	196	189	179	177	156	138	116	99	38
40		171	199	208	214	216	201	195	185	179	170	167	154	137	115	98	40
44			167	181	185	189	181	176	168	161	154	151	147	133	112	96	44
48				156	163	165	163	160	153	147	140	138	133	128	109	94	48
52				134	143	146	146	144	140	135	128	125	122	117	105	92	52
56					125	130	131	130	127	123	118	115	112	107	102	89	56
60						116	118	117	115	113	108	106	103	99	95	86	60
64						102	106	106	104	103	99	98	95	91	88	83	64
68							94	96	95	94	91	90	87	84	81	77	68
72							83	86	86	86	83	82	80	78	75	71	72
76								77	78	78	76	75	73	71	69	65	76
80									70	71	70	69	64	65	63	60	80
84									63	64	64	63	60	60	58	55	84
88										58	58	57	55	55	53	51	88
92											52	52	50	50	48,5	46,5	92
96											46,5	46,5	46	45	41,5	42	96
100												41,5	41	41	37,5	38	100
104													36,5	36,5	34	34	104
108													32	32,5	30,5	30,5	108
112														28,4	27	26,8	112
116															23,6	23,3	116
120															20	19,9	120
124																16,6	124

Traglasten über 600 t nur mit Zusatzausrüstung
 Lifting capacities above 600 t only with additional equipment
 Forces de levage plus de 600 t seulement avec équipement supplémentaire

TAB 128463 / 128052 / 128048

Hubhöhen am SDB/BW-Auslegersystem
Lifting heights on SDB/BW boom/derrick combination
Hauteur de levage en configuration SDB/BW

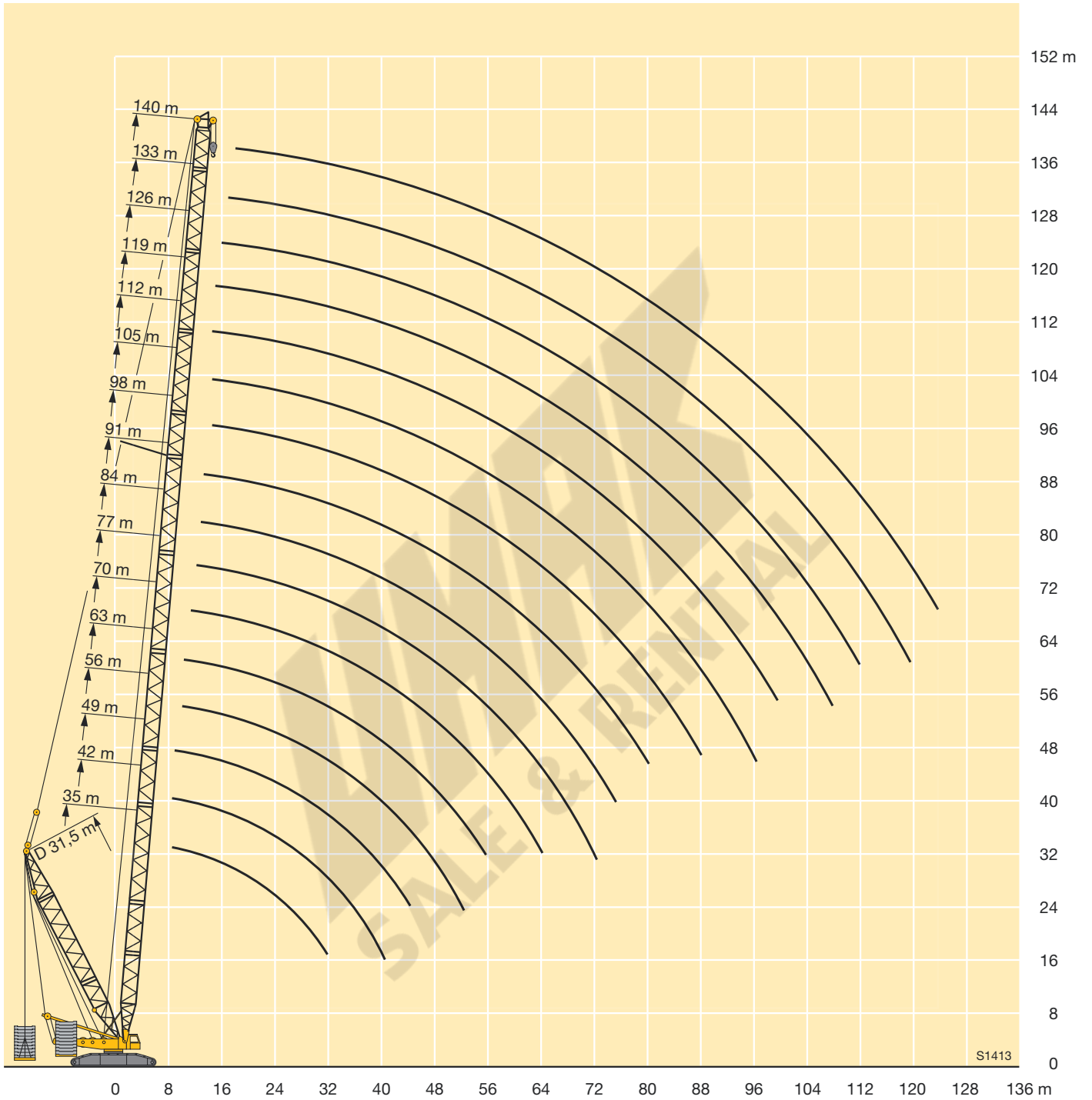

Traglasten am SW-Auslegersystem

Lifting capacities on SW boom/jib combination

Forces de levage en configuration SW

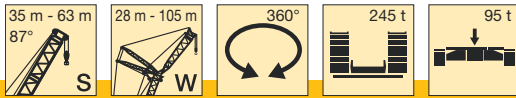

↙ m	35 m												↘ m
	28 m	35 m	42 m	49 m	56 m	63 m	70 m	77 m	84 m	91 m	98 m	105 m	
14	258												14
16	226	216	208										16
18	200	192	185	178									18
20	180	172	166	160	155								20
22	163	156	151	145	141	136							22
24	149	143	138	133	129	124	120	106					24
26	137	131	127	122	119	114	110	105	89				26
28	126	121	117	113	110	106	102	99	88	74			28
30	115	113	109	105	102	98	94	92	87	74	62		30
32		105	101	98	95	91	88	85	83	73	61	52	32
34		97	95	91	89	85	82	79	77	73	61	52	34
36		90	89	85	83	80	76	74	72	70	60	51	36
38			83	80	78	75	72	70	68	65	59	51	38
40			77	76	73	70	67	65	64	61	59	50	40
44			68	67	66	63	60	58	56	54	53	49,5	44
48				59	59	56	53	52	50	48	46,5	44,5	48
52					52	51	48	46,5	45	42,5	41,5	39,5	52
56					47	46	43	41,5	40	38	37	35	56
60						41	39	37,5	36	34	33	31	60
64						37	35,5	34	32,5	30,5	29,6	27,7	64
68							32,5	31	29,5	27,5	26,5	24,6	68
72								28,2	26,7	24,8	23,7	21,9	72
76								25,8	24,2	22,3	21,2	19,4	76
80									22	20,1	19	17,2	80
84										18,1	16,9	15,2	84
88										16,3	15,1	13,3	88
92											13,4	11,7	92
96											12	10,2	96
100												8,2	100

↙ m	42 m												↘ m
	28 m	35 m	42 m	49 m	56 m	63 m	70 m	77 m	84 m	91 m	98 m	105 m	
14	244												14
16	215	206											16
18	191	183	177	170									18
20	172	165	160	154	148								20
22	156	150	145	140	135	130							22
24	142	137	133	128	124	119	115						24
26	131	126	122	118	114	110	106	98					26
28	122	117	113	109	105	101	98	95	82	70			28
30	113	109	105	101	98	94	91	88	81	69	59		30
32		101	98	94	91	88	85	82	79	68	58	49	32
34		95	92	88	85	82	79	76	74	68	57	48,5	34
36		89	86	83	80	77	74	71	69	67	57	48	36
38		83	81	78	75	72	70	67	65	62	56	47,5	38
40			77	73	71	68	65	63	61	58	56	47	40
44			68	66	63	60	58	56	54	52	50	46,5	44
48				59	57	54	52	49,5	48	45,5	44,5	42,5	48
52					51	48,5	46,5	44,5	43	40,5	39,5	37,5	52
56					46,5	44	42	40	38,5	36,5	35	33	56
60						40	38	36	34,5	32,5	31,5	29,5	60
64						37	34,5	32,5	31	29,1	28,1	26,2	64
68							31,5	29,4	28	26,1	25,1	23,2	68
72								26,7	25,3	23,4	22,4	20,6	72
76								24,4	22,9	21	20	18,2	76
80									20,8	18,8	17,8	16	80
84									18,9	16,9	15,8	14	84
88										15,2	14	12,3	88
92											12,4	10,6	92
96											11	9	96
100												7,1	100

TAB 128056

Traglasten am SW-Auslegersystem

Lifting capacities on SW boom/jib combination

Forces de levage en configuration SW

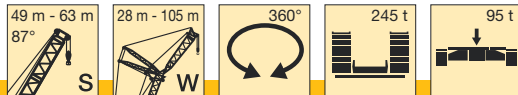

m	49 m												m
	28 m	35 m	42 m	49 m	56 m	63 m	70 m	77 m	84 m	91 m	98 m	105 m	
14	232												14
16	204	196											16
18	182	175	169										18
20	164	158	152	148									20
22	149	144	139	135	130	124							22
24	137	132	127	123	119	114	105						24
26	126	121	117	114	110	105	102	91					26
28	117	112	108	105	102	97	94	89	76				28
30	109	105	101	98	95	90	87	85	75	64	54		30
32		98	94	91	88	84	81	79	75	63	54	45,5	32
34		92	88	85	82	78	76	74	71	63	53	45	34
36		86	83	80	77	73	71	69	66	62	53	44,5	36
38		82	78	75	73	69	67	65	62	59	52	44	38
40			74	71	68	65	63	61	58	56	52	44	40
44			66	64	61	58	56	54	51	49	48	43	44
48				58	55	52	49,5	48	46	43,5	42,5	40	48
52					50	46,5	44,5	43	41	38,5	37,5	35,5	52
56					45,5	42	40	38,5	36,5	34,5	33,5	31,5	56
60						38	36,5	35	33	30,5	29,7	27,8	60
64						35	33	31,5	29,4	27,4	26,5	24,6	64
68							30	28,6	26,5	24,5	23,6	21,7	68
72								26	23,9	21,9	21	19,2	72
76								23,7	21,5	19,6	18,6	16,8	76
80									19,5	17,5	16,5	14,7	80
84									17,7	15,6	14,6	12,8	84
88										14	12,9	11,1	88
92											11,3	9,5	92
96											9,9	7,4	96
100												6,3	100
104												5,3	104

m	56 m										63 m					m		
	28 m	35 m	42 m	49 m	56 m	63 m	70 m	77 m	84 m	91 m	98 m	105 m	28 m	35 m	42 m		49 m	56 m
16	194	187											186					16
18	174	168	161										167	160	154			18
20	157	152	146	141									151	145	140	135		20
22	143	138	133	128	124								138	132	128	123	119	22
24	131	127	122	118	114	110	99						126	121	117	113	109	24
26	121	117	113	109	105	101	97	83					117	112	108	104	101	26
28	112	108	105	101	97	94	90	82	70				108	104	100	97	94	28
30	105	101	97	94	90	87	83	81	69	60			101	97	94	90	87	30
32	98	94	91	87	84	81	78	76	68	60	50		95	91	87	84	81	32
34		88	85	82	79	76	73	71	68	59	49,5	41,5		85	82	79	76	34
36		83	80	77	74	71	68	66	63	59	49	41,5		80	77	74	71	36
38		79	75	72	70	67	64	62	59	58	48,5	41		76	73	70	67	38
40			71	68	66	63	60	58	56	54	48	41			69	66	63	40
44			64	61	59	56	53	52	49	48	45,5	40				59	57	44
48				55	53	50	47,5	46	43,5	42,5	40	38				53	51	48
52					47,5	45	42,5	41	39	37,5	35,5	33,5				48,5	46	52
56					43,5	40,5	38	37	34,5	33,5	31,5	29,6					42	56
60						37	34,5	33	31	30	28	26,1						60
64						34	31	29,9	27,8	26,8	24,9	23						64
68							28,4	27	24,9	24	22,1	20,2						68
72								24,5	22,4	21,4	19,6	17,7						72
76								22,2	20,1	19,1	17,3	15,5						76
80									18,1	17,1	15,2	13,5						80
84									16,4	15,2	13,4	11,6						84
88										13,5	11,7	9,9						88
92											10,2	7,6						92
96											8,8	6,4						96
100												5,4						100
104												4,4						104

TAB 128056

Hubhöhen am SW-Auslegersystem
Lifting heights on SW boom/jib combination
Hauteur de levage en configuration SW

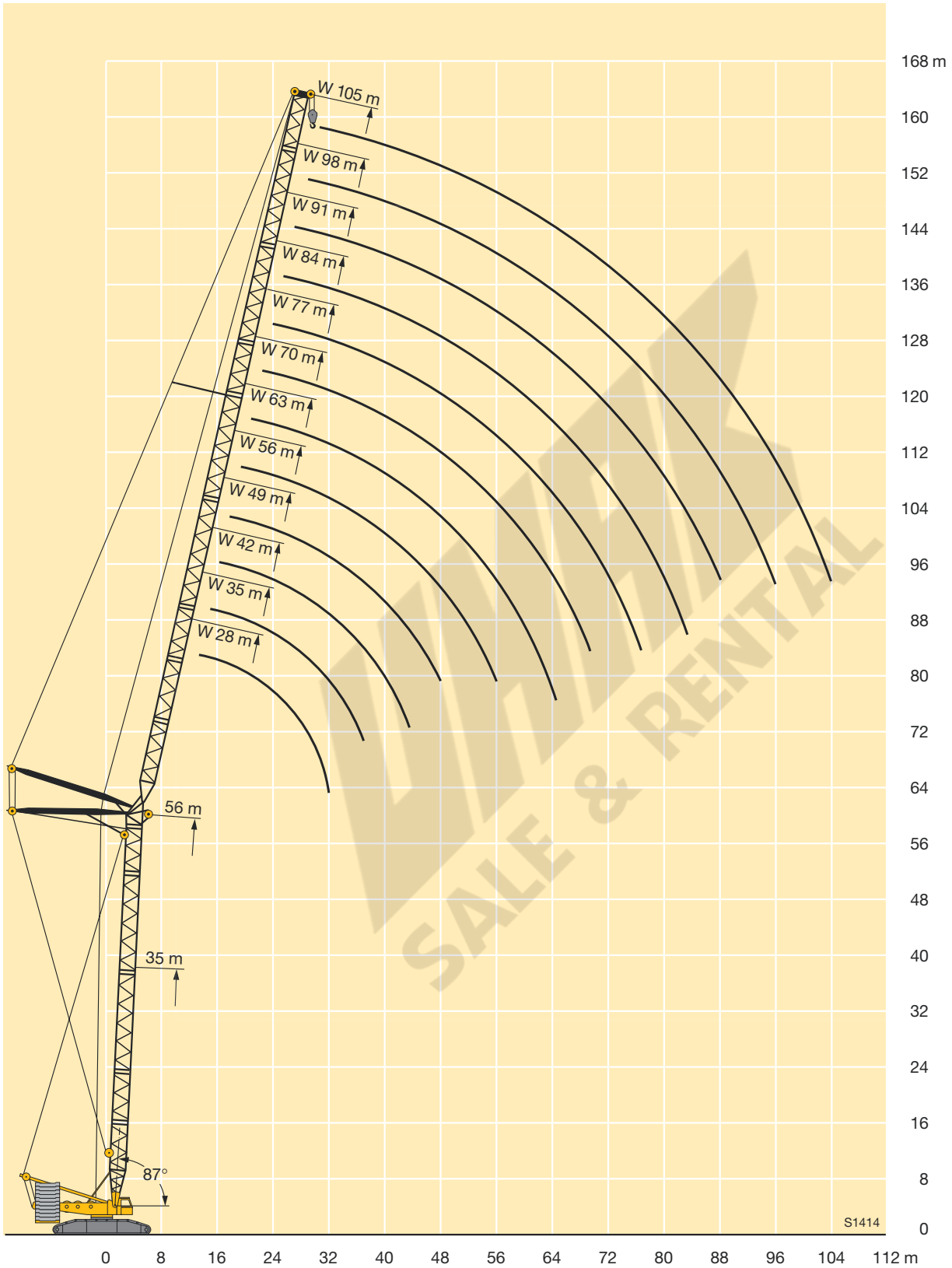

Traglasten am SDWB/BW-Auslegersystem

Lifting capacities on SDWB/BW boom/jib combination

Forces de levage en configuration SDWB/BW

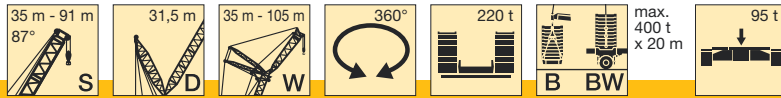

m	35 m												42 m												49 m		m
	28 m	35 m	42 m	49 m	56 m	63 m	70 m	77 m	84 m	91 m	98 m	105 m	28 m	35 m	42 m	49 m	56 m	63 m	70 m	77 m	84 m	91 m	98 m	105 m	28 m	35 m	
14	380											355												324		14	
16	372	315										344	290											313	263	16	
18	363	306	258									334	282	236										304	256	18	
20	349	298	252	211	178							323	275	231	195									295	250	20	
22	337	290	247	207	174	148						312	268	226	191	160	139							285	243	22	
24	312	281	242	203	171	146	127					302	260	221	188	158	137	118						277	236	24	
26	283	272	236	200	168	144	125	105				290	253	216	185	156	136	116	99					268	230	26	
28	256	254	230	197	166	142	124	104	88			266	246	211	182	154	134	114	98	82				259	224	28	
30	222	233	224	193	163	140	122	104	87	74	61	232	238	206	178	153	132	113	97	81	70		242	218	30		
32		216	214	190	161	138	121	103	86	74	60	52	224	202	175	150	131	111	96	80	69	58		214	32		
34		196	197	186	158	136	120	102	85	73	59	52	203	198	171	147	129	110	95	80	68	57	49	208	34		
36		174	184	183	156	134	119	101	85	73	59	51	181	190	168	144	127	109	94	79	68	57	48,5	188	36		
38			172	169	154	132	117	100	84	72	58	51	157	177	165	142	126	108	94	78	67	56	48	164	38		
40			157	160	152	131	116	100	83	71	58	50		162	162	140	124	106	93	78	67	55	47,5		40		
44			125	142	139	127	113	97	82	70	57	49,5		130	147	135	121	104	91	77	66	54	46,5		44		
48				120	125	123	110	95	80	68	56	48,5			125	128	119	102	89	75	64	53	46		48		
52					108	111	108	93	79	66	55	47,5				111	114	101	87	74	63	52	45,5		52		
56					90	99	99	91	78	65	54	46,5				93	102	98	85	73	62	51	44,5		56		
60						85	90	88	77	63	53	45,5				88	93	84	72	60	50	43,5			60		
64						70	79	81	75	62	52	44,5				74	82	82	71	59	49	42,5			64		
68							68	73	73	60	51	43,5					71	76	69	58	48	41,5			68		
72								65	68	59	50	42,5						67	68	57	47,5	41			72		
76								55	60	58	50	41,5						57	62	56	47	40			76		
80									52	56	49,5	41							54	55	46	39,5			80		
84										49,5	49,5	40,5								45,5	51	45,5	39			84	
88										42,5	45,5	40									44	45,5	38			88	
92											39,5	39,5										42	38			92	
96												33,5	36,5										35,5	37,5			96
100													31											33			100

TAB 128082 / 128078

m	49 m										56 m										63 m				m			
	42 m	49 m	56 m	63 m	70 m	77 m	84 m	91 m	98 m	105 m	28 m	35 m	42 m	49 m	56 m	63 m	70 m	77 m	84 m	91 m	98 m	105 m	28 m	35 m		42 m	49 m	
16											283												250			16		
18	215										275	231	196										243	207		18		
20		179									267	225	192	162									236	202	175	150	20	
22	207	176	150								258	220	189	159	138								227	198	171	147	22	
24	203	173	148	126							249	214	185	157	135	117							219	193	168	145	24	
26	199	170	146	125	106	92					241	209	181	155	133	116	98						213	188	164	143	26	
28	194	168	144	124	105	91	77				235	204	177	153	131	114	97	84	71				207	184	161	141	28	
30	190	164	142	123	104	90	77	66			231	199	173	150	129	112	96	83	71	60			203	180	157	139	30	
32	186	161	140	122	103	89	76	65	55		208	194	169	146	127	111	94	83	70	60	51		202	175	154	135	32	
34	183	158	137	121	102	88	75	64	54	45,5		189	165	143	125	109	93	82	69	59	50	42		170	151	133	34	
36	178	155	135	119	102	87	74	64	53	45		186	162	140	124	108	92	82	69	59	49,5	42		166	148	130	36	
38	174	153	133	116	101	87	74	63	53	44,5		165	158	138	122	106	91	81	68	58	49	41,5		165	145	127	38	
40	167	150	130	115	99	86	73	63	52	44			156	135	120	105	90	80	68	58	48,5	41,5			143	125	40	
44	136	144	127	111	96	84	72	62	52	43,5			137	130	117	103	88	78	67	57	48	40,5			140	122	44	
48		128	123	108	94	83	70	61	51	42,5				127	112	101	86	76	65	56	47	40				119	48	
52			114	105	91	81	69	60	49,5	42					109	97	84	75	64	55	46	39,5				107	52	
56				97	102	89	80	68	59	48,5	41,5				94	94	82	73	63	54	45	38,5					56	
60					90	87	78	67	58	47,5	40,5					89	81	71	62	54	44	38					60	
64						76	84	76	66	56	46,5	40					75	80	70	61	53	43	37				64	
68							73	74	65	55	46	39						71	69	60	52	42,5	36,5				68	
72								68	63	55	45	38,5							67	59	51	41,5	36				72	
76								59	63	54	44,5	38						57	58	50	41	35,5					76	
80									55	53	43,5	37,5							55	49,5	40,5	35					80	
84									47	52	43,5	37							46,5	49	40,5	34,5					84	
88										45	43	36,5									43,5	40	34,5					88
92											42,5	36										40	34,5					92
96												37	36										36	34				96
100													34											33,5				100
104														28,7											27,7			104

TAB 128082 / 128078

Traglasten am SDWB/BW-Auslegersystem

Lifting capacities on SDWB/BW boom/jib combination

Forces de levage en configuration SDWB/BW

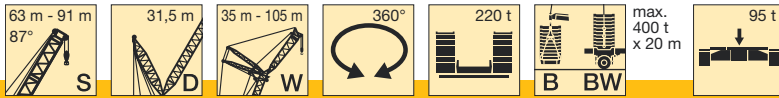

m	63 m										70 m										77 m					m
	56 m	63 m	70 m	77 m	84 m	91 m	98 m	105 m	28 m	35 m	42 m	49 m	56 m	63 m	70 m	77 m	84 m	91 m	98 m	105 m	35 m	42 m	49 m	56 m	63 m	
16								217													163					16
18								212	183												159	139				18
20								207	179	157											155	136				20
22								200	175	154	134										151	132	121			22
24	124	106						192	171	150	131	113	99								151	132	118	103		24
26	122	105	92					186	166	147	129	111	98	84							147	130	116	101	88	26
28	121	104	91	78				182	160	143	126	109	96	83	71						143	126	114	100	87	28
30	120	103	90	77	65			179	156	139	124	107	95	82	70	60					139	123	111	98	86	30
32	118	102	89	77	65	56	46,5	177	152	136	121	105	94	81	69	59	52				136	120	109	97	85	32
34	116	101	88	76	64	56	46	39,5	149	132	118	104	93	80	69	58	51	42			132	117	106	95	83	34
36	114	100	87	75	63	55	46	39,5	147	129	115	102	92	79	68	58	51	42	35,5	129	114	104	92	82	36	
38	111	98	86	74	63	55	45,5	39	146	127	113	101	90	79	68	57	50	41,5	35,5	128	112	101	90	81	38	
40	109	96	85	73	62	55	45	38,5		125	110	99	89	77	67	56	50	41,5	35		110	99	88	79	40	
44	105	93	83	72	61	54	44	38		122	107	95	86	75	66	55	49	40,5	34,5		106	95	85	76	44	
48	103	90	81	70	60	53	43,5	37,5			104	92	83	73	64	54	48,5	40	34				92	82	73	48
52	101	87	79	69	59	52	42,5	36,5			103	89	81	72	63	53	47,5	39,5	33,5				91	79	71	52
56	99	85	77	67	57	51	41,5	36				87	78	70	61	52	46,5	38,5	33				78	68	56	56
60		84	75	66	56	50	40,5	35					76	68	60	51	45,5	37,5	32,5					66	60	60
64		7 8	73	64	55	49	39,5	34,5					75	66	59	51	45	36,5	31,5					66	64	64
68			73	63	54	48,5	39	34						65	57	50	44	35,5	31						68	68
72				62	53	47,5	38	33						64	56	49	43	35	30,5						72	72
76					61	53	46,5	37,5	32,5						55	48	42,5	34,5	29,8						76	76
80						53	46	37	32								47,5	41,5	34	29,4					80	80
84						48,5	45,5	36,5	32								47	41	33	29					84	84
88							45,5	36	31,5									41	32,5	28,6					88	88
92								36	31,5									40,5	32,5	28,3					92	92
96								36	31,5										32,5	28					96	96
100									31,5											28					100	100
104									30,5											28					104	104

TAB 128082 / 128078

m	77 m						84 m						91 m						m								
	70 m	77 m	84 m	91 m	98 m	105 m	42 m	49 m	56 m	63 m	70 m	77 m	84 m	91 m	98 m	105 m	49 m	56 m		63 m	70 m	77 m	84 m	91 m	98 m	105 m	
20							125																		20		
22							122	107									94								22		
24							119	105	92								92	81							24		
26							116	103	91	79							91	79	70						26		
28	76	64					113	101	89	78	68						89	78	69	60					28		
30	75	63	55				110	99	88	77	67	59	49,5				87	76	67	59	52				30		
32	74	63	55	46,5			107	96	86	75	66	58	49	37,5			85	75	66	58	51	39			32		
34	73	63	54	46	35		104	93	84	74	65	58	48,5	37	31		82	74	65	57	50	38,5	33,5	26,1	34		
36	72	62	54	46	35	29,2	102	91	82	73	64	57	48	36,5	31	24,5	80	72	64	56	49,5	38,5	33	25,8	20	36	
38	71	61	53	45,5	34,5	29	99	89	80	71	63	56	47,5	36,5	30,5	24,3	78	70	63	55	49	38	33	25,5	19,8	38	
40	70	61	53	45,5	34	28,8	97	87	78	70	62	56	47,5	36	30,5	24,1	76	68	61	55	48	37,5	32,5	25,3	19,6	40	
44	68	60	52	44,5	33,5	28,3	94	83	75	67	59	54	46,5	35,5	29,8	23,7	73	65	58	52	46,5	36,5	32	24,8	19,2	44	
48	66	58	51	44	33	28		81	72	64	57	52	45,5	35	29,2	23,3	71	62	55	49,5	44,5	35,5	31,5	24,3	18,8	48	
52	63	56	49,5	43	32,5	27,6		79	69	62	54	50	43,5	34,5	28,7	23	69	60	53	47,5	42,5	33,5	30	23,9	18,5	52	
56	61	54	48	42	31,5	27			68	60	53	48	42	33	28	22,6		58	52	45,5	41	32,5	28,8	23,3	18,2	56	
60	59	52	47	41	30,5	26,3			67	58	51	46	41	32	27,2	22,1		57	50	44	39,5	31	27,6	22,4	17,7	60	
64	58	51	46	40	29,8	25,7				57	50	45	39,5	30,5	26,5	21,5			49	42,5	38	29,7	26,5	21,5	16,9	64	
68	57	49,5	44,5	39	29,1	25,1															41,5	37	28,7	25,5	20,6	16,2	68
72	56	48,5	43,5	38	28,4	24,5																				72	
76		48	42,5	37	28	24																				76	
80			41,5	36	27,6	23,6																				80	
84				41,5	35,5	27,2	23,3																			84	
88					35	26,8	22,9																			88	
92					34,5	26,7	22,7																			92	
96						26,7	22,3																			96	
100							22,1																			100	
104							21,9																			104	

TAB 128082 / 128078

Hubhöhen am SDWB/BW-Auslegersystem
Lifting heights on SDWB boom/derrick combination
Hauteur de levage en configuration SDWB/BW

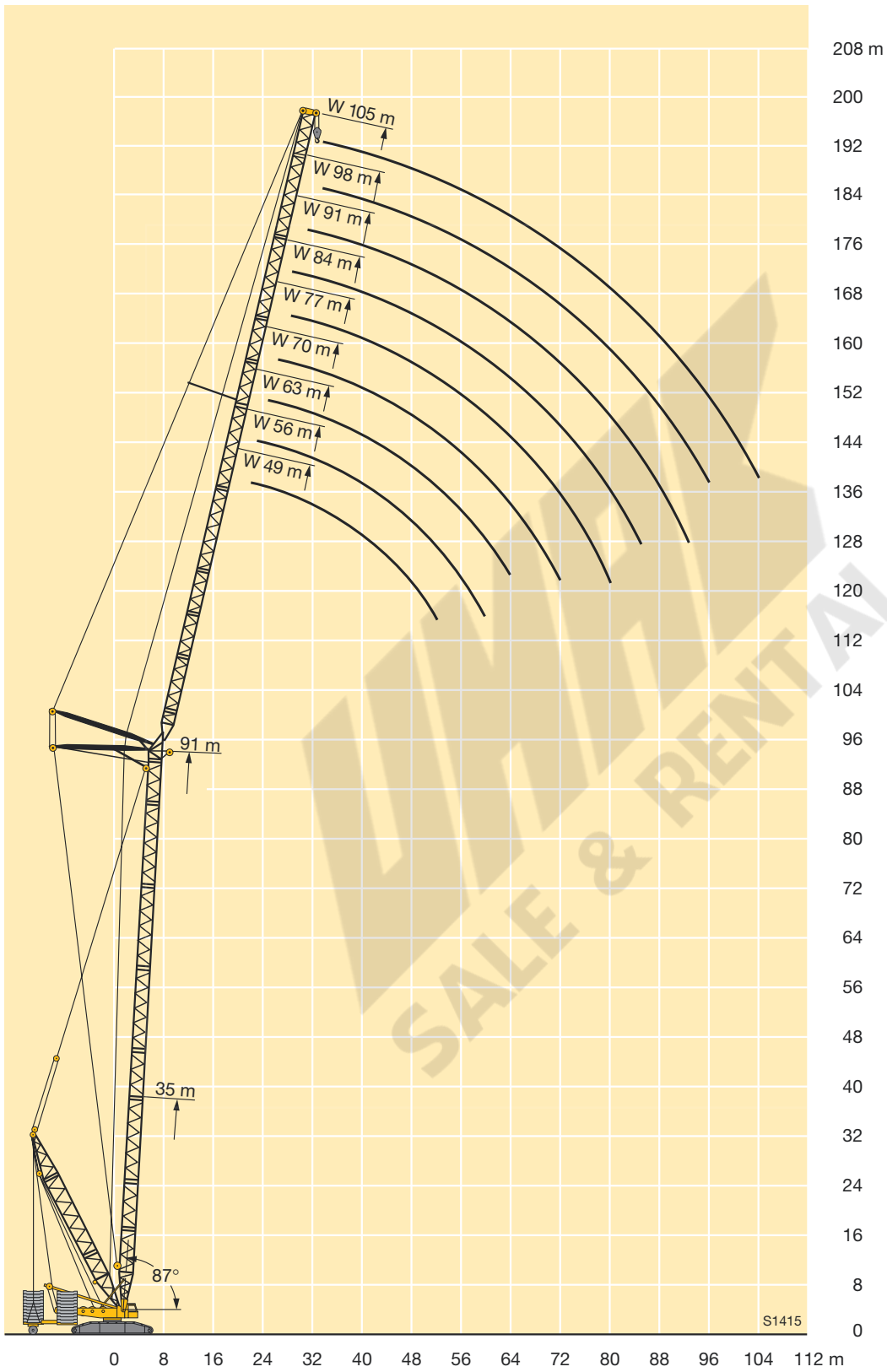

Traglasten am SDWB/BW-Auslegersystem

Lifting capacities on SDWB/BW boom/jib combination

Forces de levage en configuration SDWB/BW

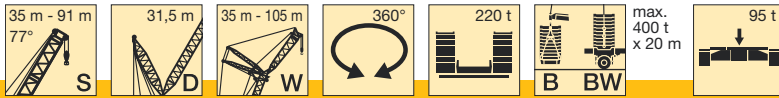

m	35 m										42 m										49 m		m				
	28 m	35 m	42 m	49 m	56 m	63 m	70 m	77 m	84 m	91 m	98 m	105 m	28 m	35 m	42 m	49 m	56 m	63 m	70 m	77 m	84 m	91 m		98 m	105 m	28 m	35 m
24	334																										24
26	316												307														26
28	300	290											291												282		28
30	286	276	251										278	268											269	260	30
32	273	264	249										265	257	232										257	248	32
34	258	249	238	203									254	246	230	189									246	238	34
36	238	236	226	201	164								244	236	228	188									237	229	36
38		216	214	199	163	142							232	226	220	187	156								227	220	38
40		202	201	193	163	141							218	212	186	155	132								214	212	40
44			173	173	160	139	119	99					186	186	182	153	131	108								190	44
48			153	150	151	137	119	99	81					165	162	150	130	108	92								48
52				135	132	132	117	98	81	68				136	144	143	128	108	92	76	63						52
56				118	120	118	116	98	80	67	55	46			129	127	125	108	92	76	63	52					56
60					108	106	105	97	80	65	54	45,5				115	114	107	92	76	63	51	43				60
64						97	95	94	80	64	54	45,5				99	104	102	92	75	62	51	43				64
68						86	87	87	80	64	53	45					93	93	91	75	62	51	42,5				68
72							80	80	76	63	53	44						85	84	75	61	50	42,5				72
76							69	73	70	62	52	43,5						75	77	75	60	50	42				76
80								66	65	61	52	43							71	70	60	49,5	41,5				80
84									60	59	52	42,5							61	64	59	49,5	41				84
88									53	55	52	42							58	58	49,5	40,5					88
92										51	50	41,5								54	49,5	40,5					92
96										43,5	46,5	41									47	49	40				96
100											42	41										45	40				100
104												38										39	40				104
108												33,5											36				108

TAB 128090 / 128086

m	49 m										56 m										63 m				m			
	42 m	49 m	56 m	63 m	70 m	77 m	84 m	91 m	98 m	105 m	28 m	35 m	42 m	49 m	56 m	63 m	70 m	77 m	84 m	91 m	98 m	105 m	28 m	35 m		42 m	49 m	
30																											30	
32																											32	
34	213																							239	212		34	
36	212	176																						218	211		36	
38	210	175																						204	203	176	38	
40	205	174	143																					193	191	175	40	
44	189	171	142	123																					170	170	146	44
48	171	167	140	122	102	86																			154	153	144	48
52	151	153	137	122	102	86	71																			139	137	52
56		138	134	121	102	86	71	60	49																	127	125	56
60		116	122	119	101	86	71	60	48,5	40,5																115	60	
64			107	108	101	86	71	60	48,5	40,5																	64	
68				98	97	85	71	59	48	40,5																	68	
72				85	89	85	71	59	48	40,5																	72	
76					80	80	71	58	47,5	40																	76	
80					74	71	57	47	40																		80	
84					65	67	57	46,5	39,5																		84	
88						62	57	46,5	39																		88	
92							54	56	46,5	39																	92	
96								50	46,5	39																	96	
100									46,5	38,5																	100	
104									41,5	38,5																	104	
108										38,5																	108	
112										34																	112	

TAB 128090 / 128086

Traglasten am SDWB/BW-Auslegersystem

Lifting capacities on SDWB/BW boom/jib combination

Forces de levage en configuration SDWB/BW

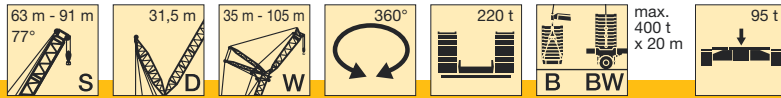

m	63 m								70 m								77 m						m				
	56 m	63 m	70 m	77 m	84 m	91 m	98 m	105 m	28 m	35 m	42 m	49 m	56 m	63 m	70 m	77 m	84 m	91 m	98 m	105 m	35 m	42 m		49 m	56 m	63 m	
34									213																	34	
36									206	183																36	
38									194	181	155											157				38	
40									182	176	154											154	137			40	
44	122								163	161	149	132	113									147	132	117		44	
48	122	105	89							145	143	128	112	96								137	127	113	100	48	
52	120	105	89	74								131	125	111	96	81						124	122	109	98	86	52
56	119	104	89	74	61							120	117	108	95	81	68	57					113	105	95	84	56
60	113	103	88	74	61	52	42					108	105	94	81	68	57	48						101	92	82	60
64	104	102	88	74	61	52	42	35,5				100	98	92	80	68	57	48	39,5	32			93	89	80	64	
68	97	95	87	74	61	52	42	35,5				91	89	79	68	57	48	39,5	32					84	77	68	
72		88	86	74	61	52	41,5	35,5						82	78	68	57	48	39	32				78	75	72	
76		81	80	73	61	52	41,5	35,5						76	74	67	57	48	39	32					70	76	
80			75	73	61	52	41,5	35,5							69	67	57	48	38,5	32						80	
84				69	61	52	41	35,5							65	63	57	48	38,5	32						84	
88				63	61	52	41	35								59	57	48	38	32						88	
92				59	52	41	35										54	48	37,5	32						92	
96				51	52	41	35										51	48	37,5	31,5						96	
100					49	41	35											45,5	37,5	31,5						100	
104						41	35												43	37,5	31,5					104	
108							40	35												37,5	31,5					108	
112								35													31,5					112	
116																					31,5					116	

TAB 128090 / 128086

m	77 m						84 m						91 m						m									
	70 m	77 m	84 m	91 m	98 m	105 m	42 m	49 m	56 m	63 m	70 m	77 m	84 m	91 m	98 m	105 m	49 m	56 m		63 m	70 m	77 m	84 m	91 m	98 m	105 m		
44							115													56						44		
48							110	99	88											55						48		
52	73						105	96	85	75									53							52		
56	73	61					102	92	82	73	64	56							51							56		
60	72	61	52	44			97	89	80	71	63	56	46,5						49,5	47,5						60		
64	71	61	52	44	32,5			86	77	69	61	55	46,5	36					46,5	36	31					64		
68	69	60	52	44	32,5	26,3		80	75	67	59	53	46,5	36	28,4	21,8			46,5	45	35,5	30,5	23,6			68		
72	68	59	52	44	32	26,3			73	65	57	52	45	36	28,4	21,8			62	61	45	43,5	34	30	23,6	72		
76	66	58	52	44	32	26,3				63	56	51	44	35	28,4	21,8			61	58	44	42	33	29,2	23,5	17,8	76	
80	64	57	51	44	31,5	26,3				61	55	49,5	43	34,5	28,3	21,8				56		41	32	28,4	22,8	17,8	80	
84	60	56	50	43,5	31,5	26,3					53	48	42	33,5	28,1	21,8				54		39,5	31	27,5	22,1	17,2	84	
88		54	49	42,5	31,5	26,3						47	41	33	27,9	21,8				53		38,5	30	26,7	21,5	16,7	88	
92		50	48,5	42	31	26,2						46	40,5	32	27,5	21,8				52		37,5	29,4	26	20,8	16,1	92	
96			46	41,5	31	26							39,5	31,5	27	21,4							28,7	25,2	20,2	15,6	96	
100				41	31	26							38,5	31	26,4	20,9							27,9	24,5	19,6	15,1	100	
104					38,5	31	26							30	25,9	20,5								23,9	19,1	14,7	104	
108						31	26								25,3	20,1								23,3	18,5	14,2	108	
112							29,4	26								24,8	19,7								18	13,7	12	112
116								25,4									19,4										13,3	116
120																	18,6										12,9	120

TAB 128090 / 128086

Hubhöhen am SDWB/BW-Auslegersystem
Lifting heights on SDWB boom/derrick combination
Hauteur de levage en configuration SDWB/BW

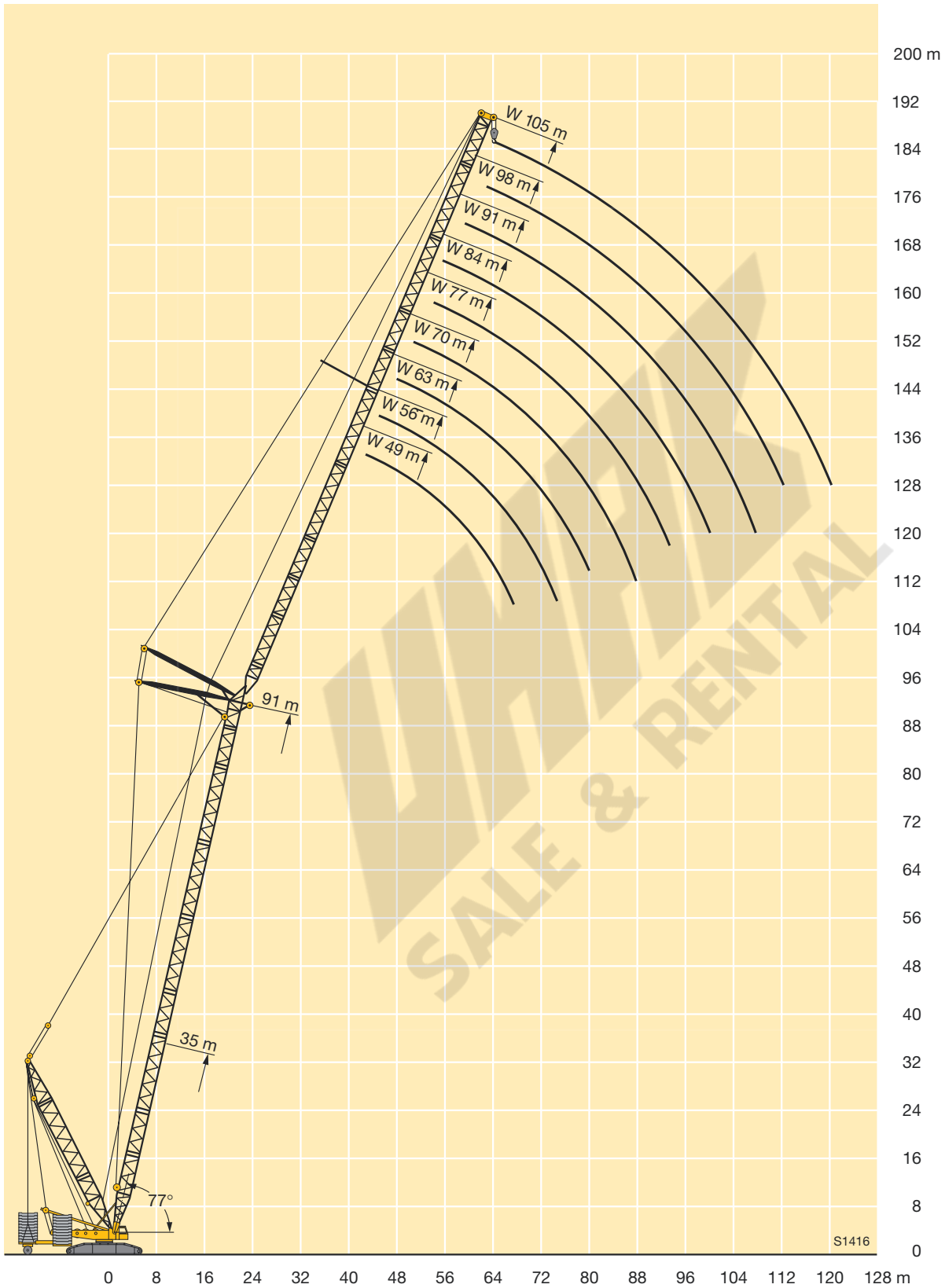

Traglasten am SDWB/BW-Auslegersystem

Lifting capacities on SDWB/BW boom/jib combination

Forces de levage en configuration SDWB/BW

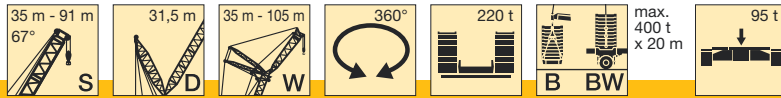

m	35 m											42 m										49 m		m					
	28 m	35 m	42 m	49 m	56 m	63 m	70 m	77 m	84 m	91 m	98 m	105 m	28 m	35 m	42 m	49 m	56 m	63 m	70 m	77 m	84 m	91 m	98 m		105 m	28 m	35 m		
34	233																											34	
36	219																												36
38	208	203											224																38
40	197	192											211														210		40
44		175	169										189	187													188	186	44
48		160	155	148									169	166													170	168	48
52			143	136	134								154	152	146													152	52
56			134	126	125	118									136	133													56
60				119	117	111	106								126	124	116												60
64					109	105	101	89							117	115	111	101											64
68					101	100	94	88	72							106	104	100	82	67									68
72						91	89	84	72	60						99	97	95	82	67	56								72
76						83	82	81	72	60	47,5					90	89	82	67	56	44,5								76
80							76	75	70	60	47,5	40					83	81	67	56	44,5	37							80
84								69	66	60	47,5	40					76	74	67	56	44,5	37							84
88								64	62	60	47,5	40						69	67	56	44,5	37							88
92									58	56	47,5	40							62	62	56	44,5	37						92
96										52	47,5	40								58	56	44,5	37						96
100											48,5	47	40								53	44,5	37						100
104												43,5	40								49	44,5	37						104
108												40,5	39,5									44	37						108
112													36,5										37						112
116																							37						116

TAB 128098 / 128094

m	49 m										56 m										63 m				m				
	42 m	49 m	56 m	63 m	70 m	77 m	84 m	91 m	98 m	105 m	28 m	35 m	42 m	49 m	56 m	63 m	70 m	77 m	84 m	91 m	98 m	105 m	28 m	35 m		42 m	49 m		
44											182																		44
48	166										165	163																	48
52	151	148										148	146																52
56	138	136	131									135	134	131															56
60	127	125	123	114									123	121	118														60
64		115	114	111	93								114	112	109	106													64
68		107	105	103	93	77								103	101	99	87												68
72			98	96	93	77	62								94	92	87	72											72
76				89	88	77	62	53							88	85	84	72	60										76
80				84	82	77	62	53	41,5							80	78	72	60	50									80
84					77	76	62	53	41,5	35						75	73	72	60	50	39,5								84
88					72	71	62	53	41,5	35							69	67	60	50	39,5	32,5							88
92						67	62	53	41,5	35								63	60	50	39,5	32,5							92
96							61	53	41,5	35								59	58	50	39,5	32,5							96
100							57	53	41,5	35									55	50	39,5	32,5							100
104								53	41,5	35									52	49,5	39,5	32,5							104
108									41,5	35										47	39,5	32,5							108
112										41,5	35											39,5	32,5						112
116											35												39,5	32,5					116
120												35												32,5					120

TAB 128098 / 128094

Traglasten am SDWB/BW-Auslegersystem

Lifting capacities on SDWB/BW boom/jib combination

Forces de levage en configuration SDWB/BW

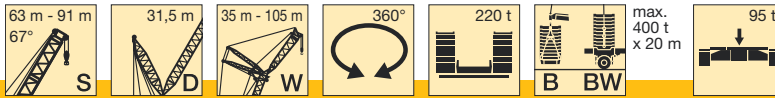

m	63 m										70 m										77 m					m
	56 m	63 m	70 m	77 m	84 m	91 m	98 m	105 m	28 m	35 m	42 m	49 m	56 m	63 m	70 m	77 m	84 m	91 m	98 m	105 m	35 m	42 m	49 m	56 m	63 m	
52									137	134											116					52
56									125	123	120										106	104				56
60										113	110	108									98	96	94			60
64	103										102	99	98									88	86	84		64
68	96	94									92	90	87									82	80	77	75	68
72	89	87	80								85	84	81	73									74	72	70	72
76	83	81	78	67							80	78	75	73	61									67	65	76
80	78	75	73	67	55							73	70	68	61	51								63	61	80
84		70	68	67	55	46							65	64	61	51	42								56	84
88			64	63	55	46	36						61	60	57	51	42	33							53	88
92			60	58	55	46	36	29,7							56	54	51	42	33	27,2						92
96				55	54	46	36	29,7							52	50	49	42	33	27,2						96
100				52	50	46	36	29,7								47	46	42	33	27,2						100
104					47,5	45,5	36	29,7									43	41	33	27,2						104
108						42,5	36	29,7									40,5	38	33	27,2						108
112						40	36	29,7										36	33	27,2						112
116							36	29,7											33,5	32,5	27,2					116
120								29,7												30,5	27,2					120
124																					26,3					124
128																					24,3					128

TAB 128098 / 128094

m	77 m							84 m							91 m							m							
	70 m	77 m	84 m	91 m	98 m	105 m	42 m	49 m	56 m	63 m	70 m	77 m	84 m	91 m	98 m	105 m	49 m	56 m	63 m	70 m	77 m		84 m	91 m	98 m	105 m			
64							89																			64			
68							83	80																			68		
72							77	74	72																		72		
76	67							68	67	64								68	60								76		
80	62	57						64	62	59	58							63	60	54							80		
84	58	57	46						58	55	53	49,5						55	52	50	47	40,5					84		
88	54	53	46	39					54	51	50	47,5	41,5					48,5	46,5	44	40	31					88		
92	50	49,5	46	39	27,4					47,5	46,5	44	41,5	31,5					43	40,5	38	30,5	25,4				92		
96	47	46	44	39	27,4	22					40,5	41	38,5	31,5	24,1				40	37,5	35,5	30,5	25,2	19,3			96		
100		43	41	39	27,4	22							38	36	31,5	24,1	18,2				35	32,5	28,6	25	19,1	14	100		
104			40,5	38	37,5	27,4	22							35,5	33	29,1	24,1	18,2				32,5	30	26,3	24	19	13,9	104	
108				35,5	34,5	27,4	22								33	30,5	26,8	24,1	18,2				27,9	24,1	21,9	18,6	13,9	108	
112					33,5	32	27,1	22								28,7	24,6	22,7	18,2					22,2	19,9	16,7	13,5	112	
116						30	25	22									22,8	20,7	17,3					20,5	17,9	14,9	12,2	116	
120							23,3	21,2									21,1	18,8	15,6						16,5	13,2	11	120	
124								21,6	19,4									17,3	14,3							15,1	11,9	9,9	124
128									17,8									15,9	13,1								11,1	8,8	128
132									16,2																			8,2	132
136																												7,7	136

TAB 128098 / 128094

Hubhöhen am SDWB/BW-Auslegersystem
Lifting heights on SDWB boom/derrick combination
Hauteur de levage en configuration SDWB/BW

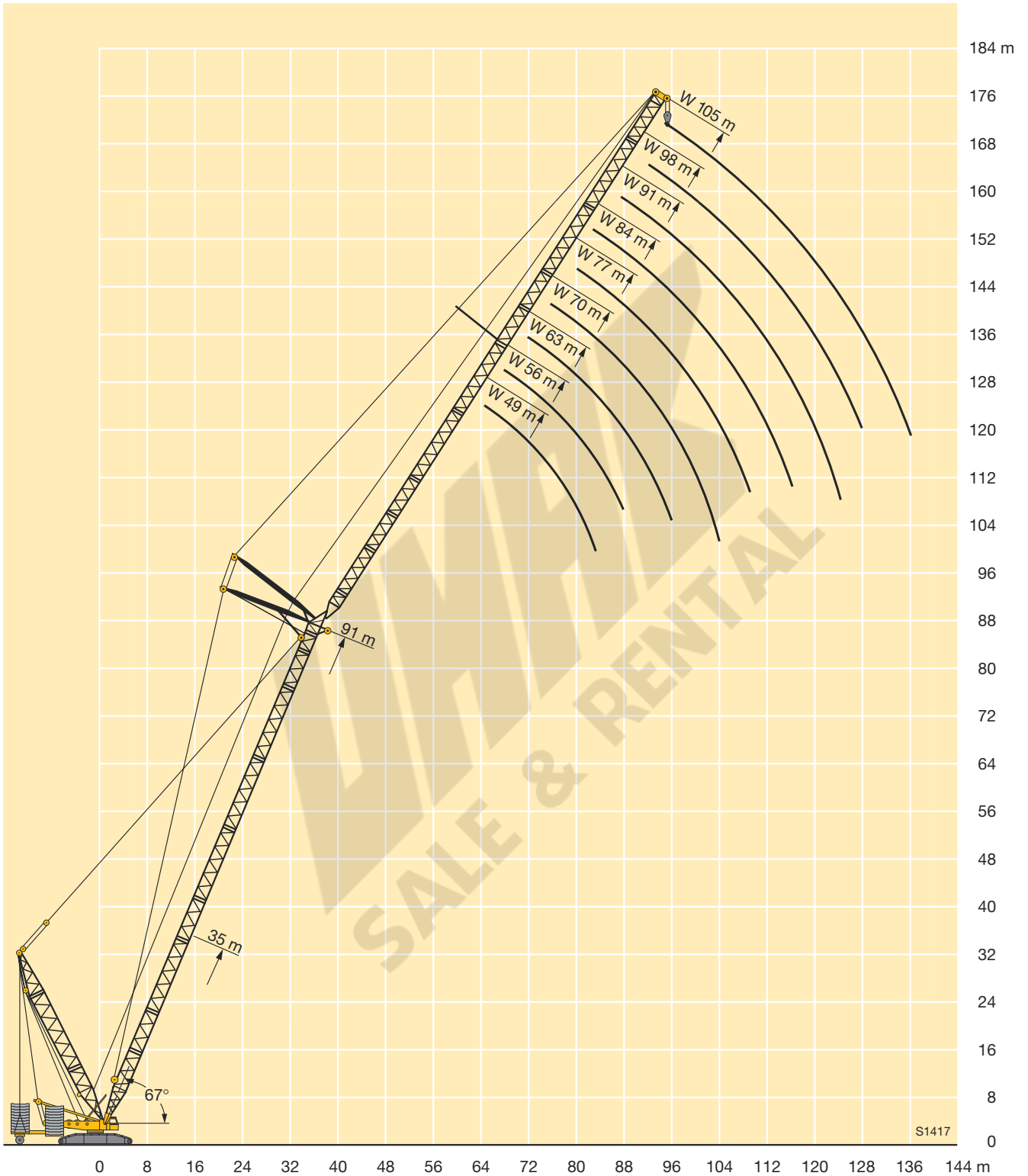

Traglasten am SDVV-Auslegersystem

Lifting capacities on SDVV boom/jib combination

Forces de levage en configuration SDVV



m	35 m		42 m		49 m*		56 m*		63 m*		70 m*		77 m*		84 m*		91 m*		m
	14 m	21 m	14 m	21 m	14 m	21 m	14 m	21 m	14 m	21 m	14 m	21 m	21 m	21 m	21 m	21 m	21 m		
10	343		338																10
11	343		328		317		315		298										11
12	316	305	312	295	302		287		272		259								12
14	282	275	266	260	253	248	241	236	230	226	219	216	206						14
16	228	235	227	223	216	212	206	203	197	194	188	186	178	170	162				16
18	197	197	192	193	187	185	179	177	171	169	163	162	155	148	141				18
20	169	171	167	167	163	162	156	155	149	148	143	143	136	130	124				20
22	145	150	145	147	144	143	138	137	131	131	126	126	120	114	109				22
24	128	132	125	130	126	127	122	122	116	116	111	112	106	101	96				24
26	115	114	109	114	108	113	109	109	103	104	98	99	94	90	85				26
28	103	103	99	99	94	99	95	98	92	93	88	89	84	79	75				28
30	92	93	89	89	85	87	82	87	81	83	78	79	75	71	66				30
32	82	85	80	81	77	77	74	76	70	75	70	71	67	63	59				32
34	73	77	71	73	69	70	67	66	63	65	60	64	60	56	52				34
36	64	69	63	66	62	63	60	60	57	56	53	56	53	53	49,5	45,5			36
38	59	62	56	60	55	57	53	54	51	51	48	48	46,5	43,5	40				38
40	55	55	49	53	48,5	51	47,5	49	45,5	46,5	43	43	39	37	35				40
44	46,5	46	41	41,5	36,5	40,5	36	39	35,5	37,5	34,5	35,5	31	25,5	22,3				44
48		39,5	34,5	34,5	30,5	30,5	25,7	29,9	26	29,5	26,1	28,1	24,7	19,6	15,6				48
52		33	28,2	29,3	25,3	24,2	20,9	21,5	17,3	22,1	18,6	21,6	18	14,1	11,3				52
56				24,5	20,6	20,3	17,1	16,2	13,3	15,1	11,5	15,5	12,3	9,1	5,9				56
60						16,6	13,5	13,2	10,2	10,6	8,4	9,8	7,2						60
64						13,2	10,1	10,4	7,4	8,1	4,8	6,1							64
68								7,8	4,5	5,4									68

* nur aufrichtbar mit Derrickballast / raisable with derrick ballast / seulement relevable avec contrepoids derrick only

TAB 128370 / 128371



m	35 m		42 m		49 m*		56 m*		63 m*		70 m*		77 m*		84 m*		91 m*		m
	14 m	21 m	14 m	21 m	14 m	21 m	14 m	21 m	14 m	21 m	14 m	21 m	21 m	21 m	21 m	21 m			
12	322		303																12
14	287		272		259		247		235		225								14
16	235	240	231	229	221	219	211	210	202	201	193								16
18	196	207	195	199	191	190	183	183	175	175	168	169	162	155	148				18
20	171	174	168	174	165	167	160	160	153	154	147	148	142	136	130				20
22	148	151	147	149	145	148	141	142	135	136	129	131	125	120	115				22
24	128	134	128	132	128	129	125	126	119	121	114	116	111	106	101				24
26	115	119	111	117	112	115	111	113	106	108	101	104	99	94	90				26
28	103	104	99	104	97	103	98	101	95	97	90	93	88	84	80				28
30	93	94	89	91	86	91	85	90	84	87	81	83	79	75	71				30
32	83	85	81	81	77	80	74	80	73	78	72	75	70	67	63				32
34	74	78	72	74	70	70	67	70	63	69	63	67	63	59	56				34
36	65	70	65	67	63	64	60	61	57	60	54	60	56	53	49				36
38	59	63	57	61	56	58	54	55	52	52	48,5	52	50	46,5	43				38
40	55	57	50	55	49,5	52	48	50	46	47,5	44	44,5	42,5	41	38				40
44	46,5	46	41,5	43,5	37,5	42	37	40,5	36,5	38,5	35	36	31,5	27,7	27,3				44
48		39,5	34,5	34,5	30,5	32	26,9	31,5	27,2	31	27	29,1	25,4	20,5	17				48
52		33,5	28,3	29,4	25,3	24,3	20,9	23,5	18,8	23,6	19,6	22,7	19,8	15,3	12,6				52
56				24,7	20,6	20,3	17	16,6	13,5	16,9	12,7	16,7	13,9	10,5	7,9				56
60				20,3		16,7	13,5	13,5	10,3	10,9	8,4	11,2	8,7	5,7					60
64						13,3	10,1	10,6	7,4	8,4	5,4	6,2							64
68								7,9	4,7	6,1									68
72								5,4											72

* nur aufrichtbar mit Derrickballast / raisable with derrick ballast / seulement relevable avec contrepoids derrick only

TAB 128376 / 128377

Hubhöhen am SDWV-Auslegersystem
Lifting heights on SDWV boom/jib combination
Hauteur de levage en configuration SDWV

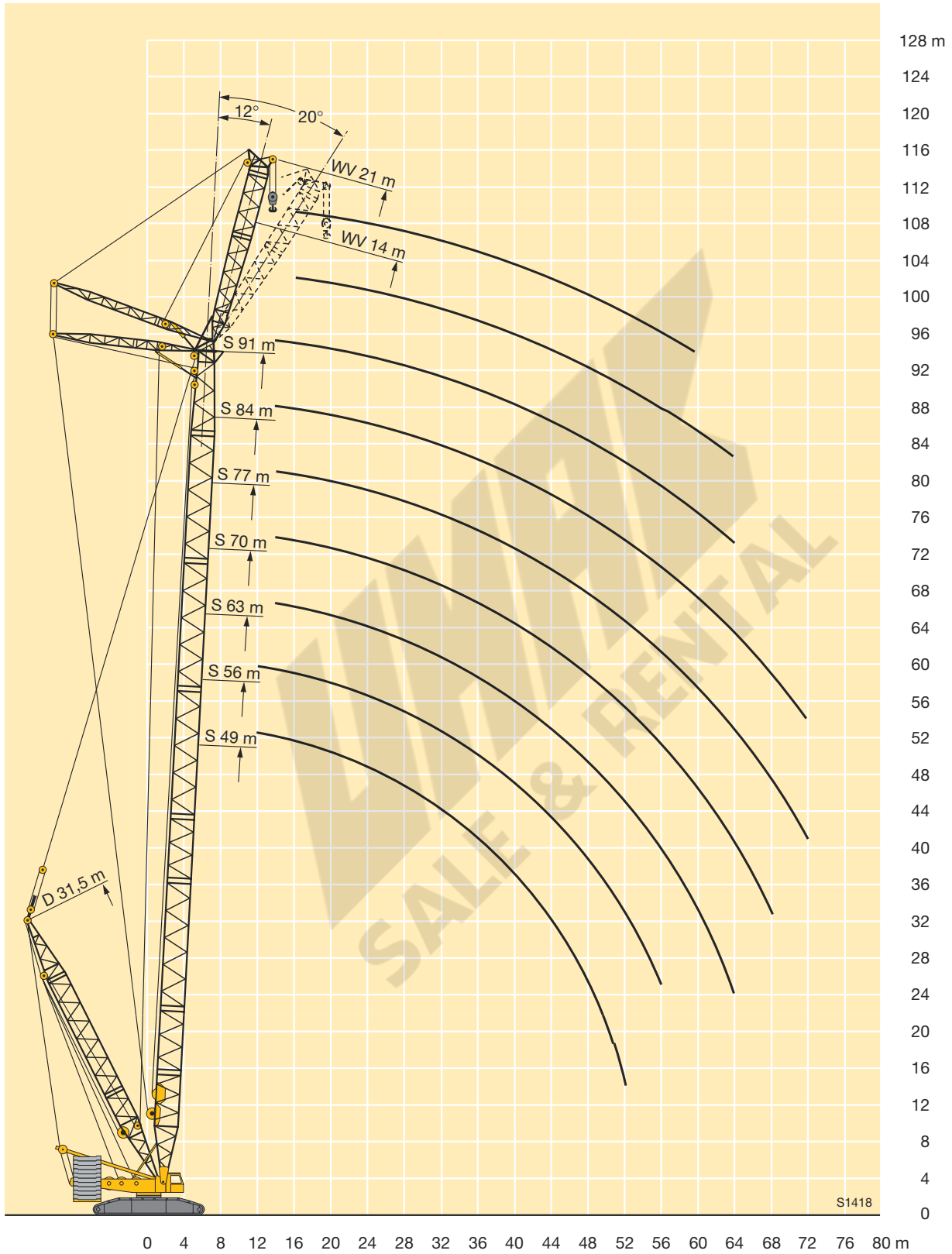

Traglasten am SDWVB/BW-Auslegersystem

Lifting capacities on SDWVB/BW boom/jib combination

Forces de levage en configuration SDWVB/BW

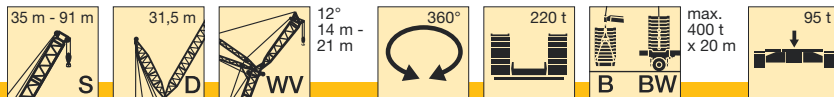

m	35 m		42 m		49 m		56 m		63 m		70 m		77 m	84 m	91 m	m
	14 m	21 m	14 m	21 m	14 m	21 m	14 m	21 m	14 m	21 m	14 m	21 m	21 m	21 m	21 m	
10	590		580													10
11	590		580		511		436		373							11
12	590	504	580	460	511		435		372		320					12
14	551	500	541	459	511	413	435	361	372	311	320	269	233			14
16	512	498	503	457	486	413	435	361	372	311	319	269	232	202	174	16
18	476	471	468	456	453	413	435	361	371	311	319	269	232	200	172	18
20	444	435	436	423	423	411	409	361	371	311	318	269	231	199	171	20
22	407	401	405	395	396	384	384	361	367	311	318	268	230	198	169	22
24	373	367	369	364	367	358	361	349	347	311	318	267	229	196	168	24
26	341	336	339	335	336	332	333	326	326	311	315	266	227	195	167	26
28	310	312	318	309	310	307	307	303	303	301	292	266	226	194	166	28
30	281	288	298	288	292	284	284	282	281	280	270	266	225	192	164	30
32	254	265	276	272	275	266	268	263	259	260	250	248	223	191	162	32
34	228	243	253	257	258	252	253	246	243	241	231	232	220	189	160	34
36	205	222	231	240	240	239	238	234	228	224	217	216	206	188	158	36
38	187	203	210	222	222	226	222	221	215	211	204	201	193	183	156	38
40	171	184	191	205	205	211	208	208	202	200	194	190	180	172	154	40
44	141	155	163	173	173	183	180	184	179	179	173	171	162	152	145	44
48		131	138	148	150	158	155	162	157	160	154	154	147	138	130	48
52		109	115	128	129	137	136	141	137	142	137	139	133	126	118	52
56				109	110	119	119	124	121	125	121	124	120	114	108	56
60						103	103	110	107	111	107	111	108	103	98	60
64						88	88	96	94	99	96	98	96	93	88	64
68								83	81	87	84	88	86	83	80	68
72										76	74	78	77	74	71	72
76										66	64	69	69	67	64	76
80												60	61	59	57	80
84													53	53	50	84
88													46	46	44	88
92														40	38,5	92
96														33,5	33	96
100															27,4	100

TAB 128352 / 128396

SALE & RENTAL

Traglasten am SDWVB/BW-Auslegersystem

Lifting capacities on SDWVB/BW boom/jib combination

Forces de levage en configuration SDWVB/BW

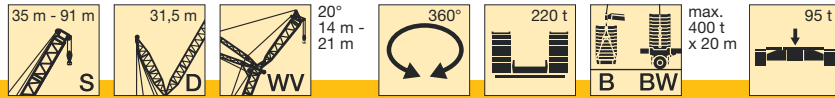

m	35 m		42 m		49 m		56 m		63 m		70 m		77 m	84 m	91 m	m
	14 m	21 m	14 m	21 m	14 m	21 m	14 m	21 m	14 m	21 m	14 m	21 m	21 m	21 m	21 m	
12	526		534													12
14	489		499		491		421		361		310					14
16	456	426	470	430	478	392	421	343	361	298	310					16
18	428	398	443	407	450	392	421	343	361	298	310	259	225	195	170	18
20	404	373	420	385	423	392	406	343	361	298	310	259	225	194	168	20
22	382	352	400	364	397	375	384	343	361	298	310	259	224	193	167	22
24	362	334	372	347	368	356	361	343	348	298	310	259	223	192	166	24
26	341	317	340	331	339	331	334	324	328	298	308	259	223	191	164	26
28	311	301	317	312	312	309	310	303	305	295	288	259	222	190	163	28
30	283	287	297	290	290	288	287	284	282	277	268	259	221	189	162	30
32	257	266	277	271	274	268	267	266	260	259	250	245	221	188	161	32
34	232	245	255	257	258	251	253	248	241	242	232	230	217	186	158	34
36	209	226	233	241	240	238	237	233	227	225	216	216	204	184	156	36
38	189	207	213	224	223	226	222	220	214	210	204	202	192	182	154	38
40	173	189	194	208	207	211	208	207	202	199	193	190	181	172	152	40
44	143	158	164	177	176	185	181	184	179	178	173	170	161	153	145	44
48		133	139	151	151	161	157	163	158	160	154	154	146	138	129	48
52		111	115	130	130	139	137	143	139	143	138	139	132	125	118	52
56				110	111	121	120	126	122	127	122	125	120	114	107	56
60				92		105	104	111	108	112	108	112	108	103	98	60
64						89	89	97	94	100	96	99	97	94	89	64
68								84	82	88	85	89	87	84	80	68
72								72		77	74	79	78	75	72	72
76										67	64	70	69	67	64	76
80												61	61	60	57	80
84												52	54	53	51	84
88													46,5	46,5	44,5	88
92														40	39	92
96														34	33	96
100															27,6	100

TAB 128356 / 128400

Hubhöhen am SDWVB/BW-Auslegersystem
Lifting heights on SDWVB/BW boom/derrick combination
Hauteur de levage en configuration SDWVB/BW

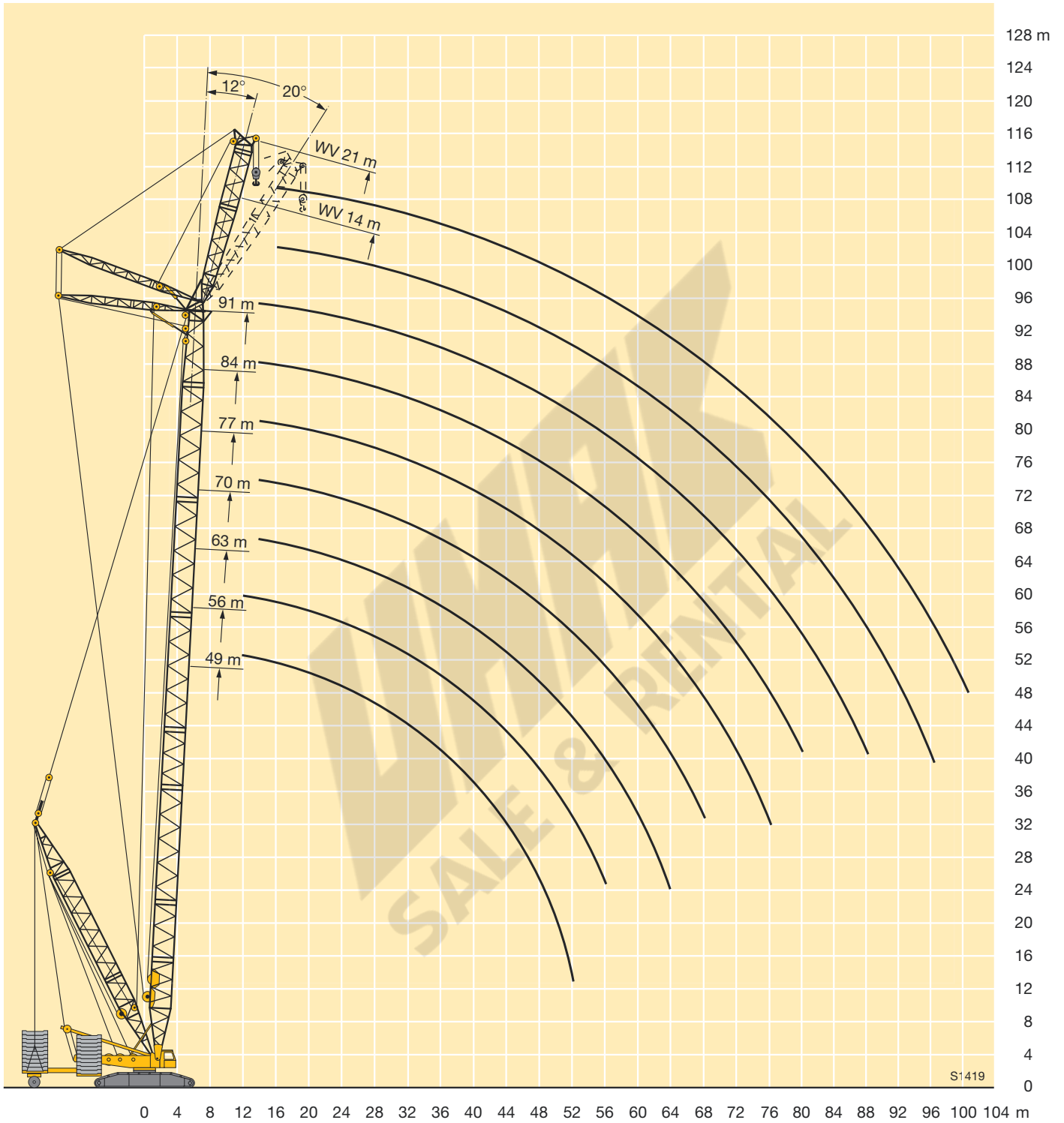

S1419



LMAR
SALE & RENTAL