

Technische Daten
Technical Data
Caractéristiques techniques

LR 1550

Raupenkran
Crawler Crane
Grue sur chenilles

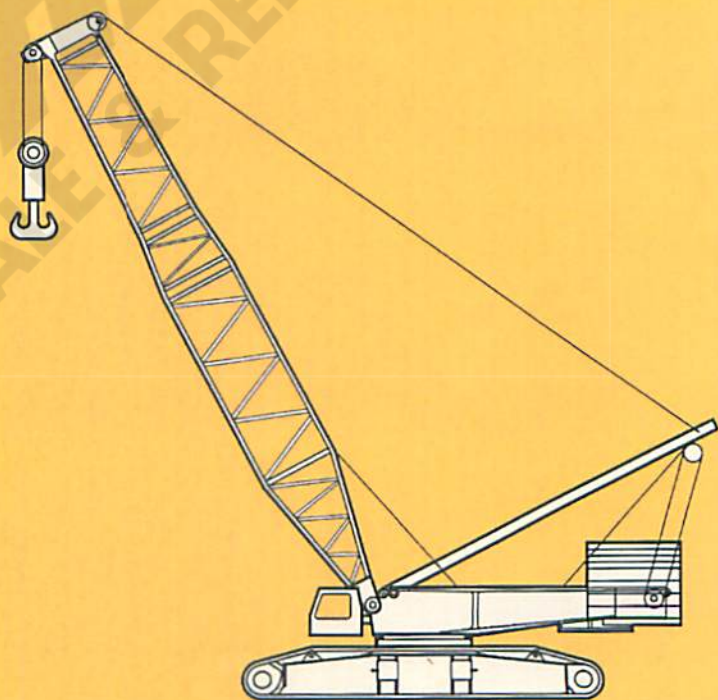

LIEBHERR

Transportplan. Transportation plan. Plan de transport.

LR1550

Drehbühne / Superstructure / Partie tournante

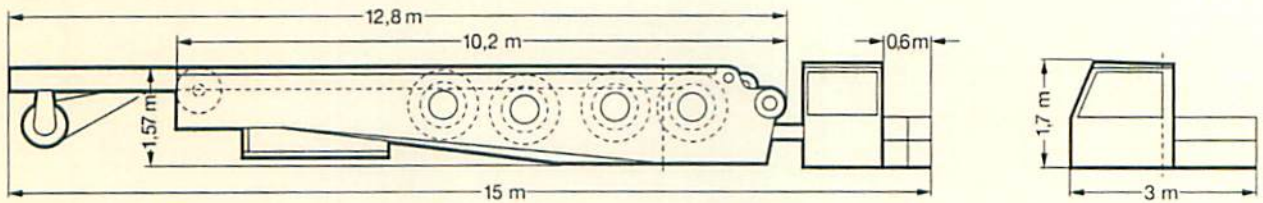

Raupennittelteil mit Drehbühne / Crawler center frame with superstructure / Partie centrale avec partie tournante

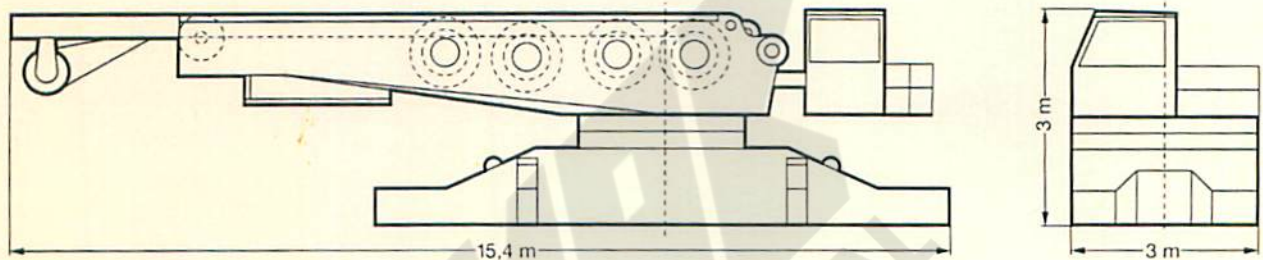

Raupennittelteil / Crawler center frame / Partie centrale

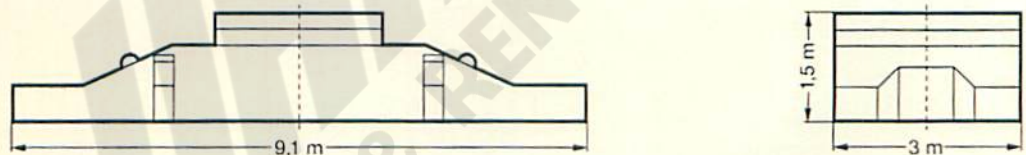

Raupenträger / Crawler carrier / Porteur chenilles

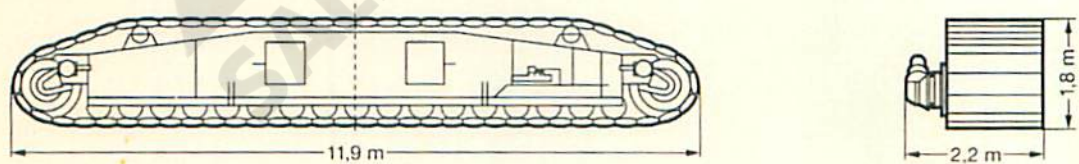

Hydraulische Abstützung für Selbstmontage / Hydr. jacks for self-erection / Support hydr. pour montage indépendant



Das Raupenfahrwerk.

Rahmen:	Eigengefertigte, verwindungssteife Schweißkonstruktion aus hochfestem Feinkorn-Baustahl. Die Raupenträger sind abnehmbar und können vom Kran selbst montiert werden.
Laufwerk:	Wartungsfreies, schmutzgeschütztes Raupenfahrwerk mit Flachbodenplatten. Plattenbreite: 1,5 m, Spurbreite: 8,5 m.
Antrieb:	Pro Raupenträger 2 hydraulische Fahrtriebe mit Planetengetrieben. Die Raupenkettens sind unabhängig und gegenläufig steuerbar, es gibt keine bevorzugte Fahrtrichtung.
Fahrleistung:	Stufenlose Geschwindigkeit von 0 - 1 km/h; Vortriebskraft pro Kette: 200 t.
Bodendruck:	Bei einem Gesamtgewicht von 371,5 t (Grundgerät mit 160 t Ballast, 21 m langem L-Ausleger und Unterflasche ca. 11 t/m ² $\hat{=}$ 1,1 kp/cm ²).
Gewicht:	Raupenmittelteil 32,5 t, Zentralballast 29 t, 2 Raupenträger 2 x 42,4 t, Montagestützen 2 t. Gesamt: 148,3 t.

Der Kranoberwagen.

Rahmen:	Eigengefertigte, verwindungssteife Schweißkonstruktion aus hochfestem Feinkorn-Baustahl. Verbindung zum Fahrwerk über dreihäufige Rollendrehverbindung, 360° schwenkbar.
Motor:	6-Zylinder-Diesel, Fabrikat Liebherr, Typ D 9406 TI-E, wassergekühlt, Leistung nach DIN 300 kW (408 PS) bei 1900 min ⁻¹ , max. Drehmoment 1730 Nm bei 1500 min ⁻¹ . Kraftstoffbehälter: 670 l.
Kranantrieb:	Hydraulisch über Pumpenverteilergetriebe mit 5 Axialkolben-Verstellpumpen mit Leistungsregelung, geschlossene Ölkreisläufe.
Kransteuerung:	Servosteuerung mit elektronischer Gleichlaufeinrichtung, Energierecycling beim Senken der Last. Alle Bewegungen werden unabhängig voneinander über Kreuzsteuerhebel gefahren.
Winden:	4 Winden hydraulisch angetrieben über Axialkolben-Verstellpumpen und Planetengetriebe. Lamellenbremsen federbelastet und hydraulisch lüftbar.
Drehwerk:	Hydraulisch angetrieben über Axialkolbenpumpe und Planetengetriebe. Lamellenbremse federbelastet und hydraulisch lüftbar. Drehgeschwindigkeit stufenlos regelbar von 0 - 1,2 min ⁻¹ .
Gegengewicht:	160 t, bestehend aus: 1 Grundplatte mit 16 t, 12 Teilen à 10 t und 4 Teilen à 6 t Gewicht.
Krankabine:	Stahlblechausführung mit Sicherheitsverglasung, seitlich schwenkbar und nach hinten neigbar, mit Bedienungs- und Kontrollinstrumenten.
Sicherheitseinrichtungen:	LICCON-Überlastanlage, Hubendbegrenzung, Sicherheitsventile gegen Rohr- und Schlauchbrüche.
Elektrische Anlage:	24 V Gleichstrom, 2 Batterien à 143 Ah.
Gewicht:	Drehbühne mit A-Bock und Winden I - IV: 42,8 t.

Die Auslegersysteme.

Leichte Ausführung:	L - LN - LD
Schwere Ausführung:	SL - SLD - SLN - SD - SDW
Zusatzeinrichtung:	Schwebeballast 250 t für LDB - SLDB - SDB - SDWB. Quick-Connection zur schnellen Drehbühnenmontage/-demontage.

Crawler track chassis.

Frame:	Self-manufactured, torsion resistant, welded construction of high-tensile steel. The crawler carriers are removable and can be re-installed by the crane itself.
Travelling gear:	Maintenance-free, tracklaying gear with flat track pads. Pad width: 1,5 m, track gauge: 8,5 m.
Drive:	Per crawler carrier, 2 hydraulic travelling drives with planetary gears. The crawler chains can be controlled independently and opposed, i. e. there is no preferential travelling direction.
Driving performance:	Infinitely variable speed from 0 to 1 km/h; propulsion power per chain: 200 t.
Ground pressure:	At a total weight of 371,5 t (basic crane with 160 t ballast, 21 m long L boom and lower hook block, approx. $11 \text{ t/m}^2 \approx 1,1 \text{ kp/cm}^2$).
Weight:	Crawler center section 32,5 t, central ballast 29 t, 2 crawler carriers 2 x 42,4 t, erection jacks 2 t. Total: 148,3 t.

Crane superstructure.

Frame:	Self-manufactured, torsion resistant, welded construction of high-tensile steel. Connected to chassis by a 3-row roller slewing ring, 360° slewing range.
Engine:	Diesel, 6 cylinder, watercooled, make Liebherr, type D 9406 TI-E, output 300 kW DIN (408 HP) at 1900 min ⁻¹ , max. torque 1730 Nm at 1500 min ⁻¹ . Fuel tank capacity: 670 litres.
Crane drive:	Hydraulically by pump transfer case and 5 axial piston variable displacement pumps with capacity control: closed hydraulic circuits.
Crane control:	Servo control with electronic synchronizing device on hoisting winches. Energy recycling during lowering of load. All motions controlled independently by joystick selectors.
Winches:	4 winches, hydraulically controlled by axial piston variable displacement pumps and planetary gears. Spring-loaded multi-disc brakes with hydraulic release.
Slewing gears:	Hydraulically controlled by axial piston pump and planetary gear, spring-loaded multi-disc brake with hydraulic release. Infinitely variable slewing speed 0 - 1,2 min ⁻¹ .
Counterweight:	160 t, consisting of: 1 base slab of 16 t, 12 slabs of 10 t each and 4 slabs of 6 t each.
Operator's cab:	Sheet steel design with safety glazing, movable sideward and inclinable to the rear; including operating equipment and check instruments.
Safety devices:	LICCON safe load indicator, hoist limit switch, safety valves to protect hydraulic system against pipe and hose fracture.
Electrical system:	24 V DC - 2 batteries, 143 Ah each.
Weight:	Superstructure with A-frame and winches I to IV: 42,8 t.

Boom configurations.

Light-weight design:	L - LN - LD
Heavy-weight design:	SL - SLD - SLN - SD - SDW
Optional features:	Suspended ballast of 250 t for LDB - SLDB - SDB - SDWB. "Quick Connection" for fast erection/dismantling of superstructure.

Châssis à chenilles.

Châssis:	Fabrication Liebherr, construction soudée en acier à résistance élevée. Les porteurs-chenilles sont démontables et peuvent être remontés par la grue elle-même.
Train de roulement:	Train de roulement sans entretien et antisalissant, patins de chenille plats, largeur de patin: 1,5 m, écartement du train de roulement: 8,5 m.
Entraînement:	Par porteur-chenille, 2 entraînements hydrauliques aux engrenages planétaires. Chaînes à chenille à commande individuelle et en sens opposé.
Performance de translation:	Réglage continu de vitesse de 0 à 1 km/h; puissance propulsive par chaîne: 200 t.
Effort au sol:	Au poids total de 371,5 t (grue élémentaire avec 160 t de lest, flèche L d'une longueur de 21 m, et moufle inférieur, env. 11 t/m ² ≈ 1,1 kp/cm ²).
Poids:	Partie centrale 32,5 t, lest central 29 t, 2 porteurs-chenilles 2 x 42,4 t, supports hydr. de montage 2 t. Total: 148,3 t.

Partie tournante.

Châssis:	Fabrication Liebherr, construction soudée en acier à résistance élevée. Liaison au châssis à chenilles par couronne d'orientation à 3 rangées de rouleaux. Orientation de 360°.
Moteur:	Diesel, 6 cylindres, marques Liebherr, type D 9406 TI-E, refroidissement par eau, puissance 300 kW DIN (408 ch) à 1900 min ⁻¹ , couple maxi. 1730 Nm à 1500 min ⁻¹ . Capacité du réservoir carburant: 670 l.
Entraînement:	Hydraulique par boîte transfert de pompe et 5 pompes à pistons axiaux à débit variable, asservissement de capacité, circuits hydrauliques fermés.
Commande de grue:	Servocommande, dispositif de synchronisation. Recyclage d'énergie en abaissant une charge. Tous les mouvements de travaux sont exécutés individuellement moyennant de combinateurs, type manche à balai.
Treuil:	4 treuils, entraînement hydraulique par pompes à pistons axiaux à débit variable et engrenages planétaires. Freins à disques multiples commandés par ressort et à desserrage hydraulique.
Mécanismes:	Entraînement hydraulique par pompe à pistons axiaux et engrenage planétaire, frein à disques multiples commandé par ressort et à desserrage hydraulique. Vitesse d'orientation à réglage continu 0 - 1,2 min ⁻¹ .
Contrepoids:	160 t, comprenant: 1 plaque à 16 t et 12 plaques à 10 t et 4 plaques à 6 t.
Cabine:	En tôle d'acier, vitres de sécurité, orientable latéralement et inclinable en arrière. Organes de commande et de contrôle.
Sécurités:	Contrôleur de charge LICCON, fin de course de levage, soupapes de sûreté, sur tubes et flexibles.
Système électrique:	24 V continu, 2 batteries à 143 Ah.
Poids:	Partie tournante avec chevalet A et treuils I à IV: 42,8 t.

Configurations de flèche.

Conception légère:	L - LN - LD
Conception lourde:	SL - SLD - SLN - SD - SDW
Equipement optionnel:	Lest suspendu de 250 t pour LDB - SLDB - SDB - SDWB. Dispositif de liaison rapide facilitant le montage/démontage de la partie tournante.

**Die Maße.
Dimensions.
Encombrement.**

LR1550

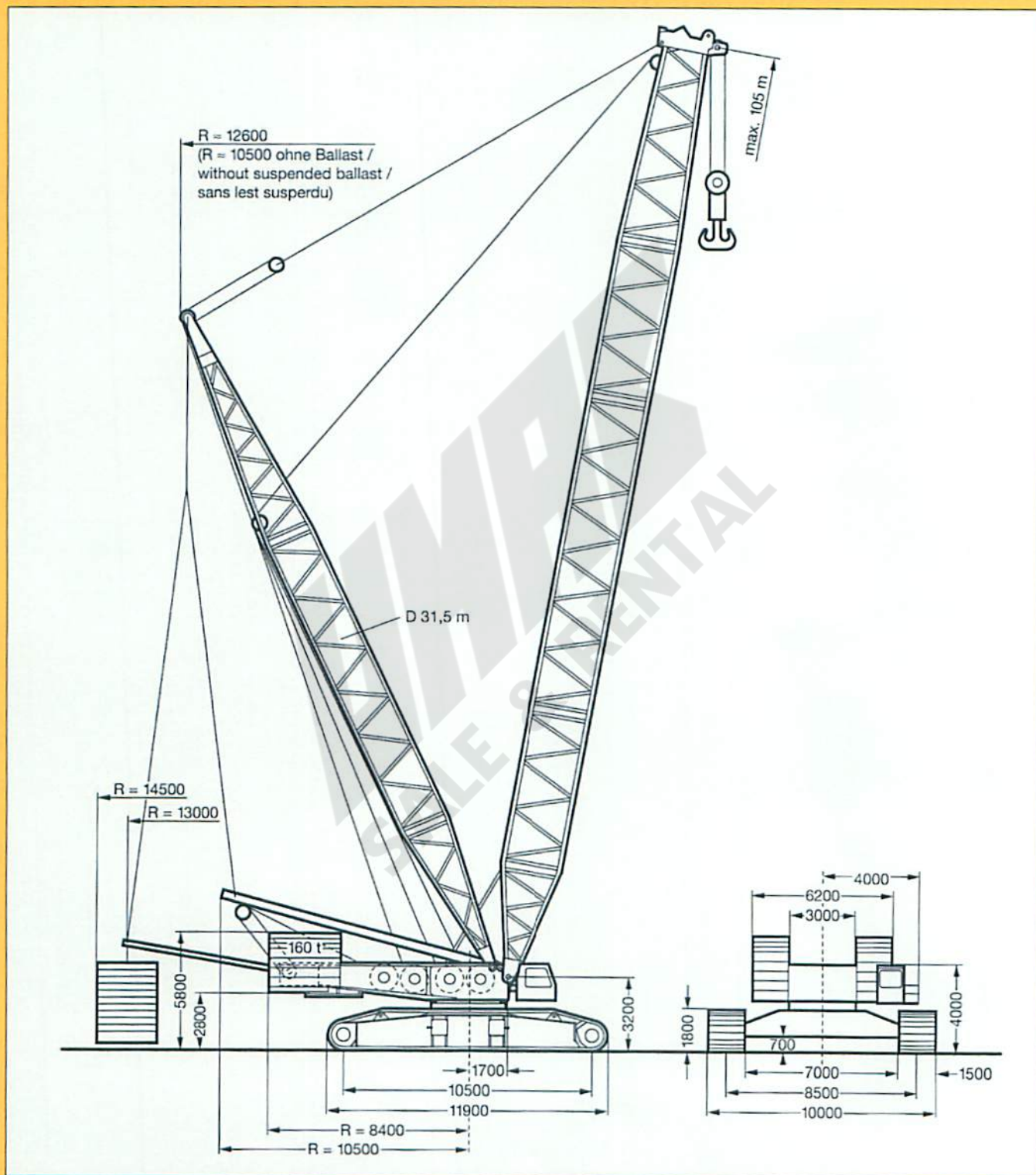

Die Lastaufnahmemittel. Hook blocks and hooks. Organes de préhension.

LR1550

Traglast t Load (metric tons) Forces de levage t	Rollen No. of sheaves Poulies	Stränge No. of lines Brins	Gewicht t Weight t Poids t
450 (225)	2 x 9 (9)	36 (18)	11 (7)
380 (190)	2 x 7 (7)	28 (14)	11 (6,5)
350	15	30	9
235	9	18	6
93	3	7	5
41	1	3	2,6
14,3	-	1	0,85

() = Doppelflasche als Einzelflasche / Double block used as single block / Moufle double employé comme moufle simple

Die Geschwindigkeiten. Working speeds. Vitesses.

Die Krangeschwindigkeiten bei Motordrehzahl 2100 min⁻¹.
Speeds of crane movements at max. engine speed of 2100 min⁻¹.
Vitesses de travail de la grue. Moteur à 2100 min⁻¹.

Antriebe Drive Entrainement	Winde I Winch I Treuil I	Winde II Winch II Treuil II	Winde III Winch III Treuil III	Winde IV Winch IV Treuil IV	Winde V Winch V Treuil V
Geschwindigkeiten Speeds Vitesses	0 - 140 m/min	0 - 140 m/min	0 - 140 m/min	2 x 0 - 50 m/min	0 - 140 m/min
Max. Seilzug Max. rope tension Effort maxi. sur brin	140 kN	140 kN	140 kN	2 x 180 kN	140 kN
Seillänge* Rope length Longueur du câble	1070 m	1070 m	1000 m	2 x 330 m	1000 m
Seildurchmesser Rope diameter Diamètre du câble	28 mm	28 mm	28 mm	28 mm	28 mm

* Es gelten die jeweiligen Ländervorschriften.
The safety regulations of the respective country shall be applicable.
Les spécifications de sécurité du pays concerné seront en vigueur.

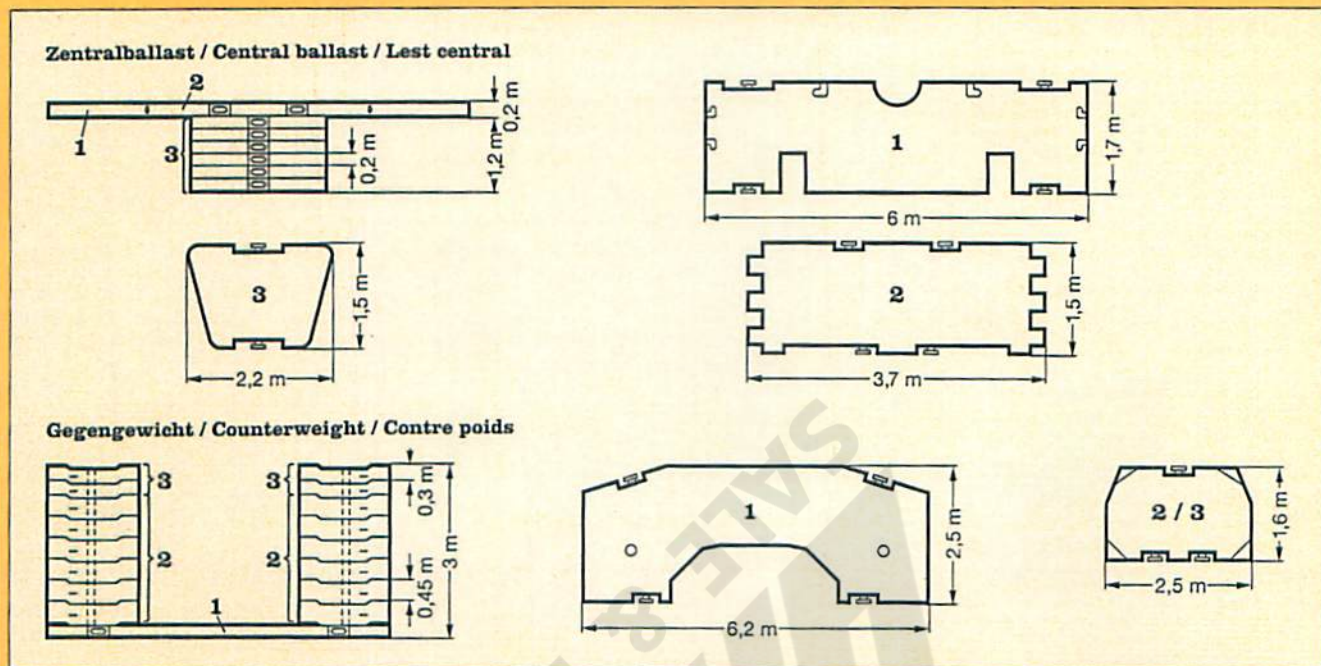

Baugruppen Components Ensembles		Gewicht t Weight t Poids t
Drehbühne mit Winden I – IV / Superstructure with winches I – IV / Partie tournante avec treuils I – IV		42,8
Krankabine / Crane cab / Cabine de grue		1,1
SA-Bock / SA-frame / Chevalet SA		6
Raupenmittellteil mit Drehbühne und Winden I – IV Crawler center frame with superstructure and winches I – IV Partie centrale avec partie tournante et avec treuils I – IV		75,3
Winde I mit Seil / Winch I with rope / Treuil I avec câble		4,8
Winde II mit Seil / Winch II with rope / Treuil II avec câble		4,8
Winde III mit Seil / Winch III with rope / Treuil III avec câble		5,5
Raupenmittellteil mit Rollendrehverbindung / Crawler center frame with slewing range / Partie centrale avec rangées de rouleaux		32,5
Raupenträger mit Kette / Crawler carrier with chain / Porteur-chenilles avec chaîne	(2 x 42,4 t)	84,8
Hydraulische Abstützung für Selbstmontage / Hydr. jacks for self-erection / Support hydr. pour montage indépendant	(4 x 0,5 t)	2
Zentralballast / Central ballast / Lest central		
Platte 1 (Standard) / Slab 1 (Standard) / Plaque 1 (Standard)	(2 x 14,5 t)	29
• Platte 2 / Slab 2 / Plaque 2	(2 x 7,4 t)	14,8
• Platte 3 / Slab 3 / Plaque 3	(12 x 4 t)	48
		81,8
Gegengewicht / Counterweight / Contrepoids		
Platte 1 / Slab 1 / Plaque 1	(1 x 16 t)	16
Platte 2 / Slab 2 / Plaque 2	(12 x 10 t)	120
Platte 3 / Slab 3 / Plaque 3	(4 x 6 t)	24
• Platte 2 / Slab 2 / Plaque 2	(4 x 10 t)	40
		200

* Zusatzgewichte / Additional ballast / Lest additionnel

Zusatzrüstungen Additional equipment Equipement optionnel		Abmessungen m Dimensions m Encombrement m	Gewicht t Weight t Poids t
Quick-Connection / Quick-Connection / Dispositif de liaison		3 x 3 x 0,3	4,8
Schwebeballast / Suspended ballast / Lest suspendu			max. 250
Ballastpalette mit Anhängereinrichtung Ballast pallet with suspension device	(1 x 10 t)	6,5 x 2,1 x 1,2	10
Palette à lest avec dispositif de suspension Ballastplatte / Ballast slab / Plaque de lest	(24 x 10 t)	2,5 x 1,6 x 0,4	240
Zusatzabstützungen / Additional mech. outriggers / Supports additionnels	(2 x 6,5 t)	6,8 x 0,7 x 1,9	13

Leichtes Auslegersystem Light weight boom/jib combination Conception légère flèche configuration	L, LD, LDB, LN	Abmessungen m Dimensions m Encombremment m	Gewicht t* Weight t Poids t
¹⁾ L-Anlenkstück / Pivot section / Élément de base L-Adapter / Adapter section / Adaptateur L-Kopfstück / Head section / Élément de tête	12 m 6,5 m 350 t / 0,5 m	12,4 × 3 × 3 6,7 × 2,6 × 2,4 3 × 2,3 × 1,2	6,3 3 3,3
LI-Reduzierstück / Reducing section / Élément réducteur	2 m	2,4 × 3 × 2,8 m	1,5
²⁾ N-Anlenkstück / Pivot section / Élément de base N-Kopfstück / Head section / Élément de tête	9 m 10 m	14,4 × 2,5 × 3,1 11 × 2,3 × 2,3	13 2,9
NI-Reduzierstück / Reducing section / Élément réducteur	2 m	2,2 × 2,3 × 1,9	0,7
LN-Verstellflaschen / Luffing blocks / Moufles de relevage		2,5 × 1,9 × 1,3	2,9
D-Anlenkstück / Pivot section / Élément de base D-Kopfstück mit Flasche / Head section with block / Élément de tête avec moufle	7 m 10,5 m	7,3 × 2,7 × 2,3 13,3 × 2,6 × 2,6	4,1 8,3
H-Mastnase / Boom nose / Bec de mât	40 t	4,4 × 2,3 × 1,6	0,7

¹⁾ mit Rückfallstützen / with fall back prevention / avec supports anti retour

²⁾ kpl. Montageeinheit / compl. erection unit / unité de montage

Schweres Auslegersystem Heavy weight boom/jib combination Conception lourde flèche configuration	SL, SLD, SLDB, SLN, SD, SDB, SDW, SDWB	Abmessungen m Dimensions m Encombremment m	Gewicht t* Weight t Poids t
¹⁾ S-Anlenkstück / Pivot section / Élément de base SL-Reduzierstück / Reducing section / Élément réducteur L-Adapter / Adapter section / Adaptateur L-Kopfstück / Head section / Élément de tête	12 m 2 m 6,5 m 350 t / 0,5 m	12,4 × 3 × 3 2,4 × 3 × 2,8 m 6,7 × 2,6 × 2,4 3 × 2,3 × 1,2	15,3 1,5 3 3,3
S-Kopfstück / Head section / Élément de tête	450 t / 9 m	9,8 × 3 × 2,8	12,6
¹⁾ W-A-Bock I + II / A-frame I + II / Chevalet I + II W-Anlenkstück / Pivot section / Élément de base L-Adapter / Adapter section / Adaptateur L-Kopfstück / Head section / Élément de tête	14 m 6,5 m 350 t / 0,5 m	16,8 × 3 × 2,4 14,3 × 2,6 × 2,3 6,7 × 2,6 × 2,4 3 × 2,3 × 1,2	10 6,7 3 3,3
Winde V mit Seil / Winch V with rope / Treuil V avec câble Winde I/II mit Seil / Winch I/II with rope / Treuil I/II avec câble Winde III mit Seil / Winch III with rope / Treuil III avec câble		1,9 × 1,7 × 1,3 1,4 × 1,8 × 1,5 1,5 × 1,8 × 1,3	5 4,8 5,5

¹⁾ mit Rückfallstützen / with fall back prevention / avec supports anti retour

Ausleger-Zwischenstücke Boom/jib intermediate sections Éléments intermédiaires de flèche et fléchette	S		LA		LI - D - W		NA		NI		
	7 m	14 m	7 m	14 m	7 m	14 m	7 m	14 m	7 m	14 m	
Gewicht* Weight Poids	t	6,8	12,1	3,7	6,6	3,4	6,2	1,6	2,9	1,5	2,9
Systemmaß Dimension of system Encombremment système	m	2,8 × 2,44		2,8 × 2,44		2,42 × 1,98		2,1 × 1,61		1,8 × 1,31	

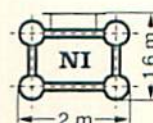
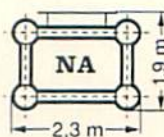
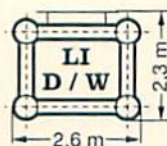
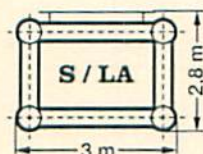

* Gewichte inkl. Abspannstangen und Bolzen / Weights including stay rods and bolts / Poids avec barres de haubanage et boulons

Die Traglasten am L-Ausleger. Lifting capacities at L boom. Forces de levage à la flèche principale L.



21 m – 105 m



8,8 m x 8,5 m



360°

160 t
200 t

90 t

	21 m	28 m	35 m	42 m	49 m	56 m	63 m	70 m	77 m	84 m	91 m	98 m	105 m				
4,5	550													4,5			
5	500													5			
5,5	461	400												5,5			
6	426	380	330											6			
6,5	395	365	322											6,5			
7	369	350	315	275										7			
8	325	324	301	264	235	200								8			
9	291	290	290	255	227	193	160							9			
10	263	262	275	245	219	186	155	130	113					10			
11	239	254	253	235	211	180	150	125	109	95	82			11			
12	234	233	232	227	203	173	145	121	106	92	79	68		12			
14	201	200	199	198	190	161	135	114	100	87	74	64	55	14			
16	176	175	174	172	171	150	126	107	95	82	70	60	52	16			
18	155	154	153	152	151	138	117	102	90	78	66	57	49	18			
20	138	137	136	135	134	129	109	97	86	75	63	55	46	20			
22		123	122	121	120	119	102	92	82	71	60	52	44	22			
24		112	111	110	109	108	95	87	79	68	58	50	42	24			
26		102	101	100	99	98	89	82	76	65	56	47	40	26			
28			93	92	91	90	85	78	73	62	53	45	38	28			
30			86	85	83	83	80	75	70	60	51	44	37	30			
32			80	78	77	76	75	72	68	58	49	42	35	32			
34				73	72	71	70	68	65	55	48	41	34	34			
36				68	67	66	65	64	62	53	46	39	32	36			
38				63	62	61	61	59	58	51	44	38	31	38			
40					58	57	56	55	54	50	42	37	30	40			
44					51	50	49	47,5	47	45	40	34	28	44			
48						44	43	41,5	41	39	37	32	26	48			
52							38	37	36	34	33	29	23	52			
56							34	32,5	31,5	29,9	28,9	27	22	56			
60								29,2	28	26,2	25,1	23,7	20	60			
64									24,9	23	21,8	20,4	18	64			
68									21,9	20,3	19	17,4	16	68			
72										17,8	16,4	14,8	13,3	72			
76											14,2	12,5	10,9	76			
80											12,2	10,3	8,5	80			
84												8,3	6,7	84			
88													5,4	88			
92													4,2	92			
m/s*	14				13				11				9				m/s*

Traglasten über 350 t nur mit Zusatzeinrichtung.
Lifting capacities above 350 t only with special equipment.
Forces de levage plus de 350 t seulement avec équipement spécial.

TAB 50013 / 50011

* Zulässige Windgeschwindigkeit.
Permissible wind speed.
Vitesse du vent admissible.

Anmerkungen zu den Traglasttabellen.

- Die angegebenen Traglasten überschreiten nicht 75 % der Kipplast.
- Für die Kranberechnungen gelten die DIN-Vorschriften lt. neuem Gesetz gemäß Bundesarbeitsblatt vom 2/85; Die Traglasten 75 % (Standicherheit) entsprechen DIN 15019, Teil 2. Für die Stahltragwerke gilt DIN 15018, Teil 3. Die bauliche Ausbildung des Krans entspricht DIN 15018, Teil 2 sowie der F. E. M.
- Die Traglasten sind in Tonnen angegeben.
- Das Gewicht des Lasthakens bzw. der Hakenflasche sowie der Anschlagmittel ist von den Traglasten abzuziehen.
- Die Ausladungen sind von Mitte Drehkranz gemessen.
- Die Aufstandsfläche muß eben und tragfähig sein.

Remarks referring to load charts.

- The tabulated lifting capacities do not exceed 75 % of the tipping load.
- When calculating crane stresses and loads, German Industrial Standards (DIN) are applicable, in conformity with new German legislation (published 2/85); the 75 % lifting capacities (stability margin) are as laid down in DIN 15019, part 2. The crane's structural steelwork is in accordance with DIN 15018, part 3. Design and construction of the crane comply with DIN 15018, part 2, and which F. E. M. regulations.
- Lifting capacities are given in metric tons.
- The weight of the hook blocks and hooks as well as of lifting tackle must be deducted from the lifting capacities.
- Working radii are measured from the slewing centreline.
- The subsoil must be even and of good bearing capacity.

Remarques relatives aux tableaux des charges.

- Les forces de levage indiquées ne dépassent pas 75 % de la charge de basculement.
- Conformément au nouveau texte de loi paru au bulletin fédéral de février 1985, les normes DIN ci-après sont appliquées pour les calculs relatifs à la grue: charges à 75 % suivant les prescriptions de la norme DIN 15019, 2ème partie. La norme DIN 15018, 3ème partie est appliquée pour les charpentes. La construction de la grue est réalisée conformément à la norme DIN 15018, 2ème partie, et aux règles de la F. E. M.
- Les forces de levage sont données en tonnes.
- Le poids des moufles et crochets ainsi que des élingues doit être soustrait des charges indiquées.
- Les portées sont calculées à partir de l'axe de rotation.
- Le sol doit être plat et résistant.

Sein größtes Lastmoment ist 5568 tm.

Die Hubhöhen am L-Ausleger.
Lifting heights at L boom.
Hauteurs de levage à la flèche principale L.

LR 1550

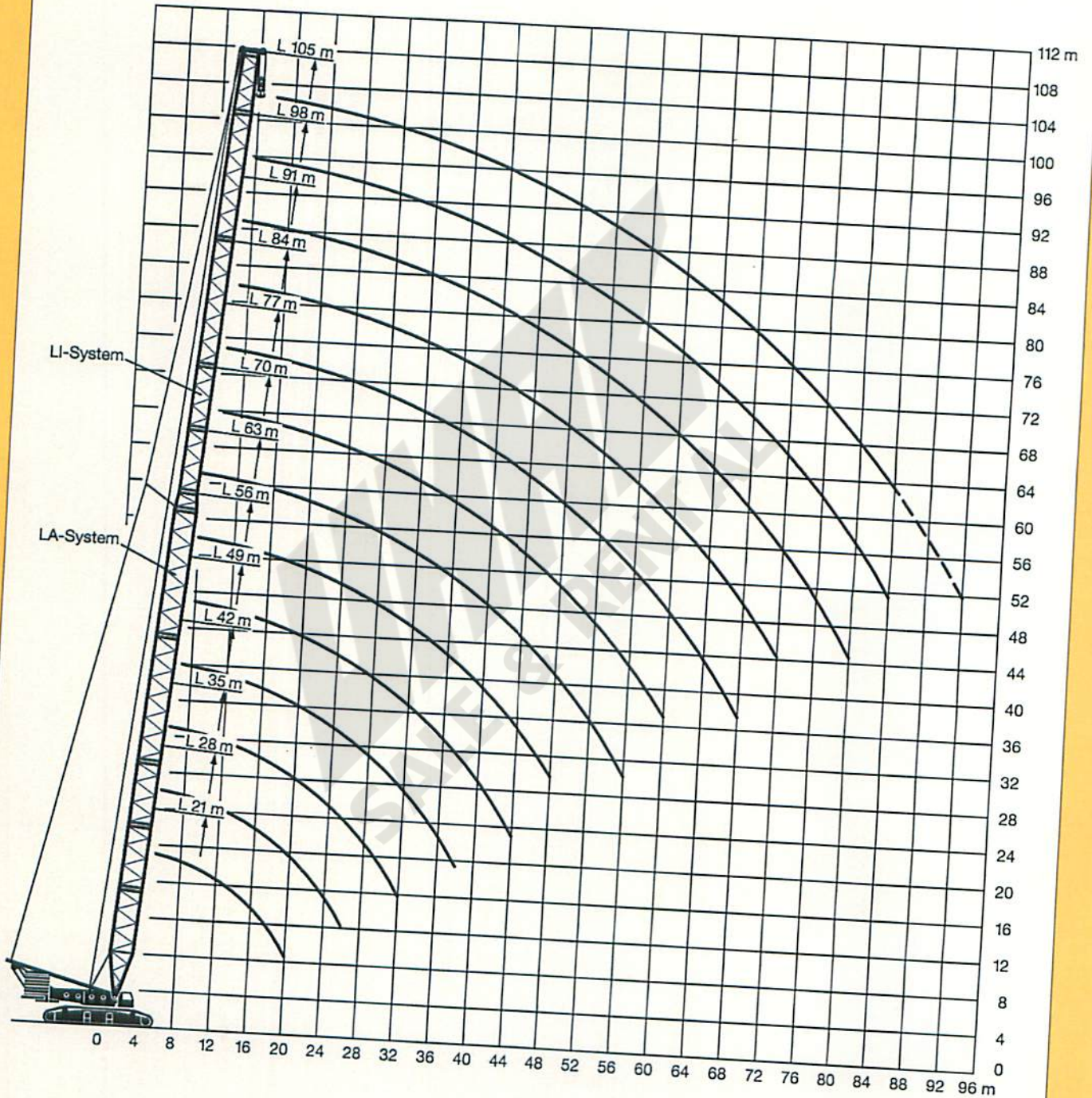

Die Traglasten am LD-Auslegersystem. Lifting capacities at LD boom/derrick combination. Forces de levage en configuration LD.

LR1550



35 m -
98 m



31,5 m



8,8 m x
8,5 m



360°



160 t
200 t



90 t

	35 m	42 m	49 m	56 m	63 m	70 m	77 m	84 m	91 m	98 m		
9	294										9	
10	265	264									10	
11	241	256									11	
12	236	234	233	229							12	
14	202	200	199	199	184						14	
16	176	175	173	173	172	164	143				16	
18	156	154	153	153	152	151	143	122	99		18	
20	139	138	137	136	135	135	134	120	97	84	20	
22	125	123	122	122	121	120	119	117	95	81	22	
24	113	112	110	110	109	108	107	106	92	79	24	
26	103	102	100	100	99	98	97	97	90	77	26	
28	95	93	92	91	91	90	89	88	86	74	28	
30	87	86	85	84	83	82	81	81	79	72	30	
32	81	80	78	78	77	76	75	74	73	69	32	
34		74	73	72	71	70	69	68	68	65	34	
36		69	68	67	66	65	64	63	63	61	36	
38		65	64	63	62	61	60	59	58	56	38	
40			60	59	58	57	56	54	54	52	40	
44			53	52	51	50	48,5	47	46,5	44,5	44	
48				46	45	44	42,5	41	40	38,5	48	
52					40	39	37,5	35,5	35	33	52	
56					36	34,5	33	31,5	30,5	28,6	56	
60						31	29,1	27,5	26,4	24,7	60	
64							25,9	24,3	23,1	21,3	64	
68								23,1	21,4	18,3	68	
72									18,9	15,6	72	
76										15,2	76	
80										13,1	80	
84										9	84	
m/s*	14		13			11			9			m/s*

* Zulässige Windgeschwindigkeit.
Permissible wind speed.
Vitesse du vent admissible.

TAB 50022 / 50020



35 m -
98 m



31,5 m



8,8 m x
8,5 m



360°



160 t



30 t

m	35 m	42 m	49 m	56 m	63 m	70 m	77 m	84 m	91 m	98 m	m
12											12
14	189	188	215	204							14
16	164	163	181	172	165						16
18	143	142	155	149	143	137	131				18
20	124	123	136	130	125	120	115	111	99		20
22	109	108	120	115	111	107	103	99	95		22
24	96	95	107	103	99	96	92	88	88	84	24
26	86	85	94	93	90	87	83	80	77	81	26
28	78	77	84	84	82	79	75	72	70	74	28
30	71	70	76	75	74	72	69	66	64	67	30
32	65	64	69	68	68	66	63	60	58	61	32
34		59	63	62	61	60	58	55	53	55	34
36		54	57	57	56	55	53	51	49	51	36
38		50	53	52	51	51	49	47	45	46,5	38
40			49	48	47,5	46,5	45,5	43,5	41,5	42,5	40
44			45,5	44,5	44	43	42	40	38,5	39,5	44
48			39,5	38,5	37,5	37	36	34,5	33	36	48
52				34	33	32	31	29,9	28,2	31	52
56					28,8	27,8	26,7	25,7	24,2	26,2	56
60					25,5	24,3	23,1	22	20,6	22,3	60
64						21,3	19,9	18,8	17,4	18,9	64
68							17,2	16,1	14,7	15,7	68
72							14,9	13,7	12,2	12,9	72
76								11,7	10,1	10,5	76
80									8,3	6,5	80
m/s*	14						11		9		m/s*

* Zulässige Windgeschwindigkeit.
Permissible wind speed.
Vitesse du vent admissible.

TAB 50019

Its maximum load moment is 5568 tm.

**Die Hubhöhen am LD-Auslegersystem.
Lifting heights at LD boom/derrick combination.
Hauteurs de levage en configuration LD.**

LR1550

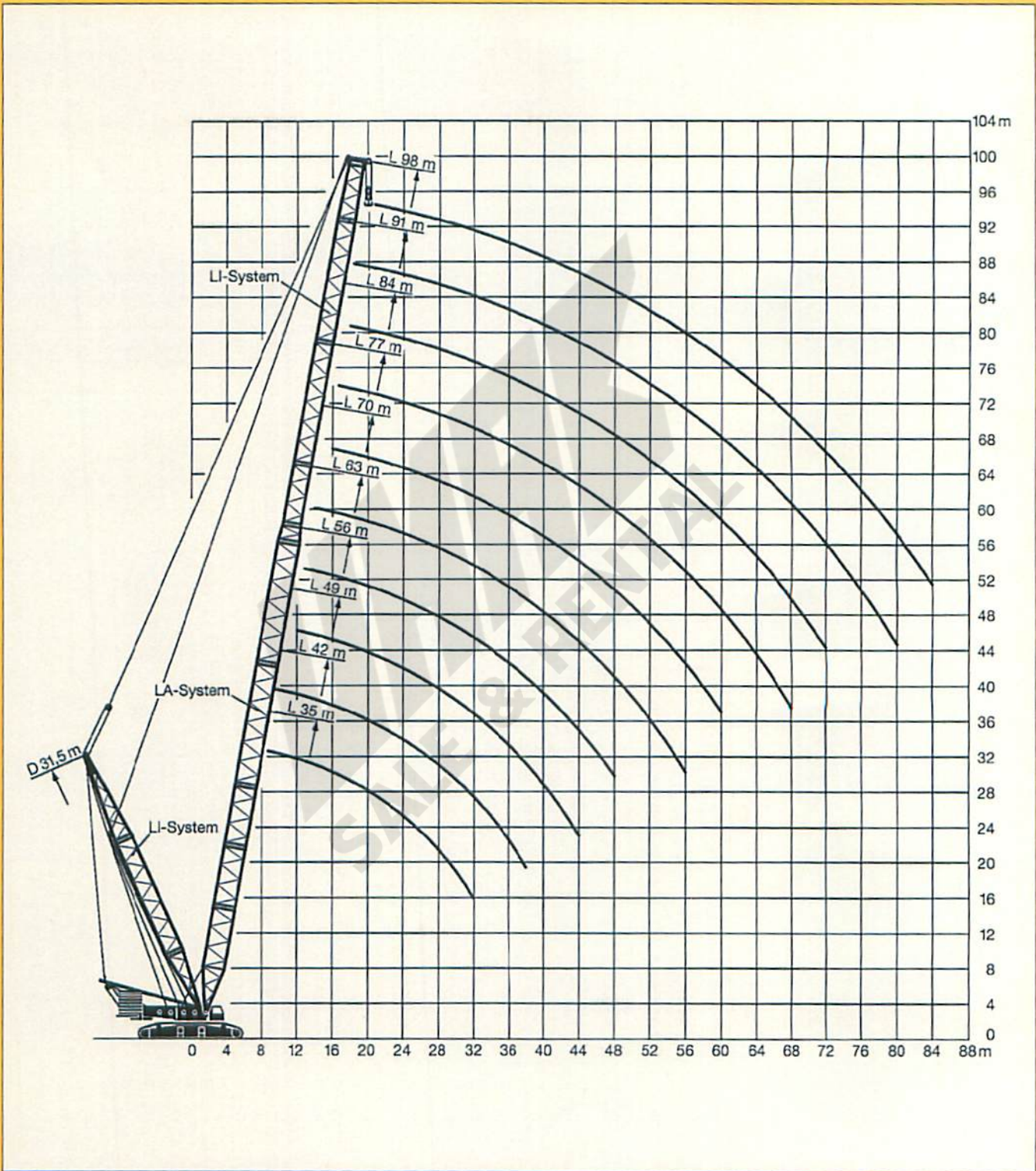

Die Traglasten am LDB-Auslegersystem.

LR1550

Lifting capacities at LDB boom/derrick combination.

Forces de levage en configuration LDB.



35 m -
98 m



31,5 m



8,8 m x
8,5 m



360°





160 t



250 t



30 t

 m	35 m	42 m	49 m	56 m	63 m	70 m	77 m	84 m	91 m	98 m	 m
9	380										9
10	374	314									10
11	368	312									11
12	362	311	272	229							12
14	356	307	266	224	184						14
16	348	304	259	219	179	164	143				16
18	306	301	252	213	175	160	143	122	99		18
20	271	270	246	208	171	157	142	120	97	84	20
22	242	241	239	203	167	153	141	117	95	81	22
24	219	218	217	197	163	149	138	115	92	79	24
26	199	198	197	192	159	145	135	112	90	77	26
28	183	182	181	180	154	142	133	110	88	74	28
30	169	168	167	166	150	138	130	107	85	72	30
32	156	155	154	153	146	134	127	105	83	69	32
34		144	143	143	142	130	124	102	81	67	34
36		135	134	133	132	127	122	100	78	65	36
38		127	126	125	124	123	119	97	76	62	38
40			118	117	117	116	115	94	74	60	40
44			105	104	103	103	102	88	69	55	44
48				94	93	92	91	82	65	51	48
52					83	82	81	76	60	47	52
56					76	75	73	70	56	43	56
60						68	67	64	51	40	60
64							61	58	46	36	64
68							56	52	42	33	68
72								46	37	29	72
76									33	26	76
80									28	22	80
84										19	84
m/s*	14			13			11		9		m/s*

Traglasten über 350 t nur mit Zusatzeinrichtung.
Lifting capacities above 350 t only with special equipment.
Forces de levage plus de 350 t seulement avec équipement spécial.

TAB 50195

250 t Schwebeballast mit 13 m Ausladung.
Suspended counterweight of 250 t with 13 m radius.
250 t lest suspendu avec 13 m de portée.

* Zulässige Windgeschwindigkeit.
Permissible wind speed.
Vitesse du vent admissible.

SALE & RENTAL

Couple de charge maxi. 5568 tm.

**Die Hubhöhen am LDB-Auslegersystem.
Lifting heights at LDB boom/derrick combination.
Hauteurs de levage en configuration LDB.**

LR1550

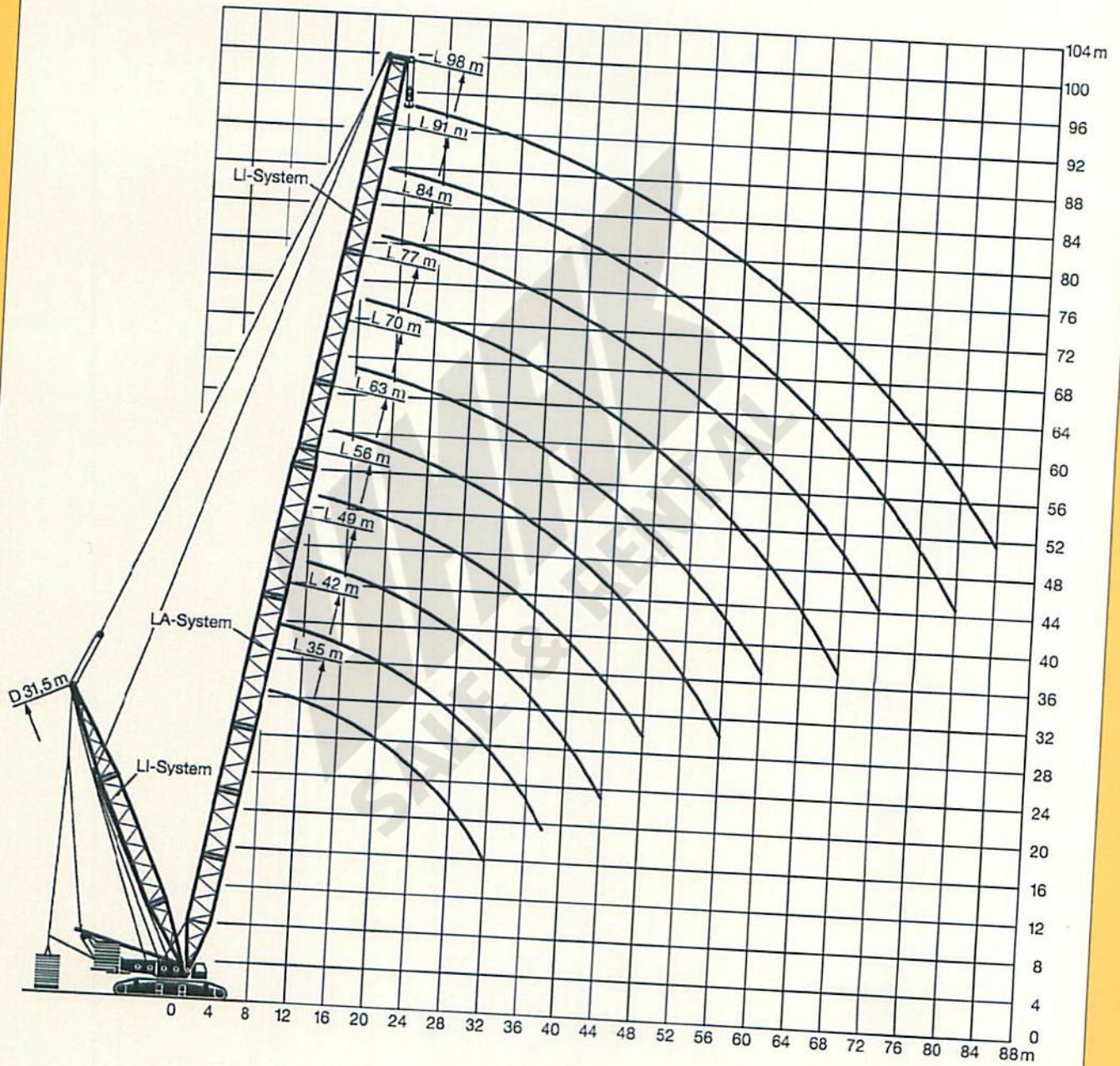

Die Traglasten an der LH-Mastnase. Lifting capacities at LH boom nose. Forces de levage à la bec de mât LH.

LR1550



21 m -
105 m



2,7 m



8,8 m x
8,5 m





360°



180 t



90 t

 m	21 m	28 m	35 m	42 m	49 m	56 m	63 m	70 m	77 m	84 m	91 m	98 m	105 m	 m			
6,5	40	40												6,5			
7	40	40	40											7			
8	40	40	40	40										8			
9	40	40	40	40	40	40								9			
10	40	40	40	40	40	40	40							10			
11	40	40	40	40	40	40	40	40	40					11			
12	40	40	40	40	40	40	40	40	40	40	40			12			
14	40	40	40	40	40	40	40	40	40	40	40	40		14			
16	40	40	40	40	40	40	40	40	40	40	40	40	40	16			
18	40	40	40	40	40	40	40	40	40	40	40	40	40	18			
20	40	40	40	40	40	40	40	40	40	40	40	40	40	20			
22	40	40	40	40	40	40	40	40	40	40	40	40	38	22			
24		40	40	40	40	40	40	40	40	40	40	40	36	24			
26		40	40	40	40	40	40	40	40	40	40	40	34	26			
28		40	40	40	40	40	40	40	40	40	40	39	32	28			
30			40	40	40	40	40	40	40	40	40	38	31	30			
32				40	40	40	40	40	40	40	40	36	29	32			
34				40	40	40	40	40	40	40	40	35	28	34			
36					40	40	40	40	40	40	40	38,5	33	36			
38					40	40	40	40	40	40	40	36,5	32	38			
40					40	40	40	40	40	40	40	34,5	31	40			
44						36,5	34,5	36	35	34	32,5	28	22	44			
48							30,5	29	30,5	29,5	28,5	27,5	26	48			
52								24,5	26	25	23,5	23	22,9	52			
56									21	21,9	20,9	19,7	18,6	56			
60										18,7	17,6	16,2	15	60			
64											14,6	13,1	11,9	64			
68												12,1	10,5	68			
72													9,2	72			
76													8,2	76			
													6,7				
													4,5				
													4,3				
m/s*	14				13				11				9				m/s*

* Zulässige Windgeschwindigkeit.
Permissible wind speed.
Vitesse du vent admissible.

TAB 50067

Die Hubhöhen an der LH-Mastnase.
Lifting heights at LH boom nose.
Hauteurs de levage à la bec de mât LH.

LR 1550

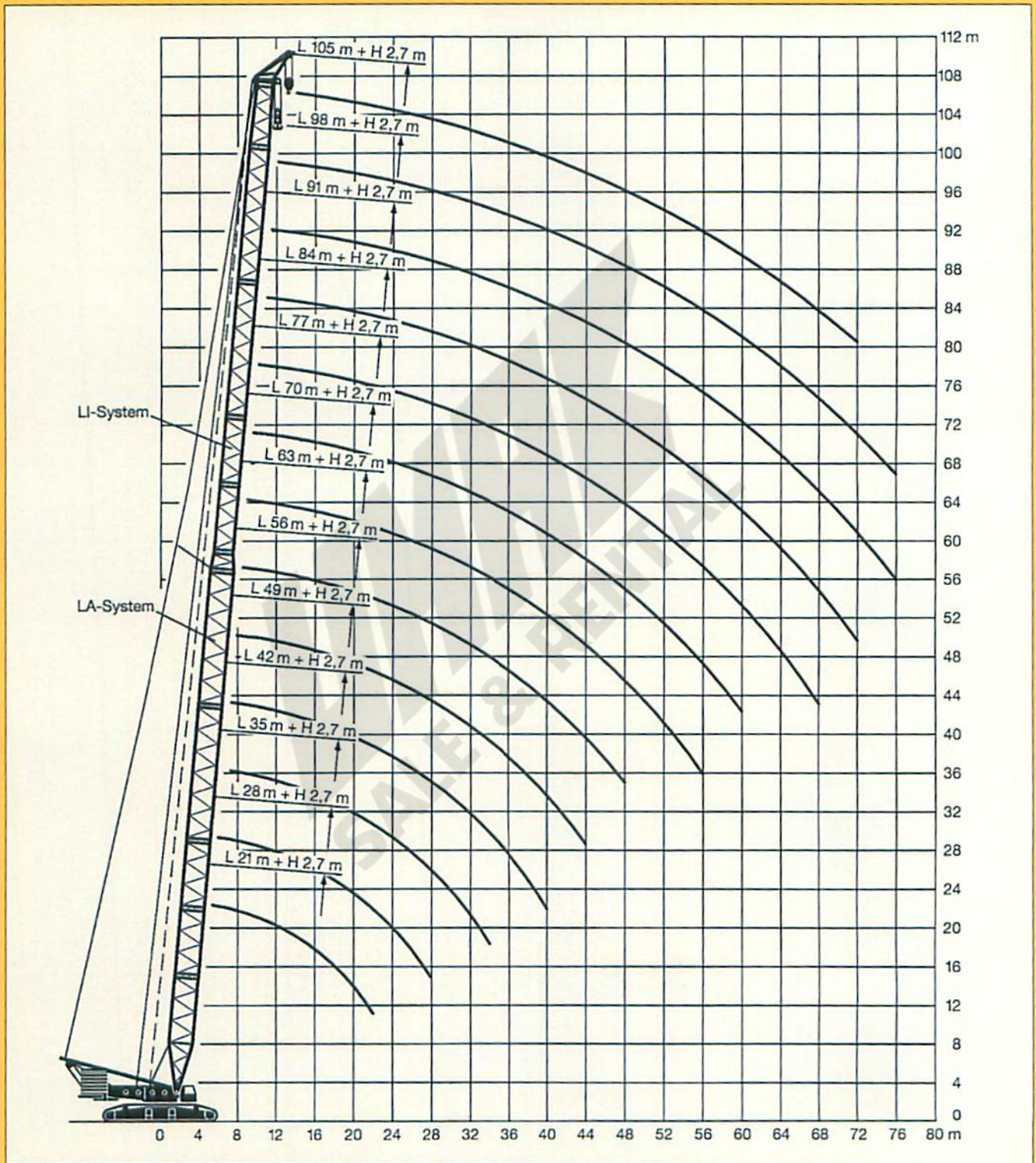

Die Traglasten am LN-Auslegersystem. Lifting capacities at LN boom/jib combination. Forces de levage en configuration LN.

LR 1550



87°
28 m -
77 m



21 m -
91 m



8,8 m x
8,5 m



360°



160 t



30 t

m	28 m											35 m											m
	21 m	28 m	35 m	42 m	49 m	56 m	63 m	70 m	77 m	84 m	91 m	21 m	28 m	35 m	42 m	49 m	56 m	63 m	70 m	77 m	84 m	91 m	
12	130											130											12
14	130	122										129	114										14
16	128	118	107	91								122	110	101	86								16
18	122	114	104	89	76							117	107	98	84	71							18
20	117	110	101	87	73	60						112	102	94	81	69	58						20
22	108	106	98	84	71	58	51					108	99	91	79	67	56	48,5					22
24	78	98	95	82	69	56	50	41				85	96	88	76	65	55	47,5	39				24
26		88	87	79	67	55	49	40	33			90	85	74	63	53	46,5	38	32				26
28		80	79	77	65	54	48	39,5	32	28		81	81	72	61	52	45	37,5	31,5	26,5			28
30		65	72	72	63	52	46,5	38,5	31,5	27,3	23,6	69	74	69	59	51	44	36,5	31	26	22,5		30
32			67	66	60	51	45,5	37,5	31	26,7	23,1		68	67	57	49,5	43	36	30,5	25,5	22		32
34			61	61	58	49,5	44	36,5	30,5	26,1	22,5		62	62	55	48	42	35	29,6	25	21,5		34
36			54	56	56	48	43	36	29,8	25,6	22		57	57	53	47	41	34,5	29	24,6	21,1		36
38			43,5	52	53	46,5	42	35	29,3	25	21,6		47	53	51	45,5	40	33,5	28,5	24,1	20,6		38
40				48	49,5	45,5	40,5	34	28,7	24,5	21,1		49,5	49,5	44	39	33	28	23,6	20,2			40
44				34,5	43,5	42,5	38,5	32,5	27,5	23,5	20,3			37	43,5	41	36,5	31,5	26,8	22,8	19,4		44
48					35	38	36	31	26,4	22,5	19,5				37	38,5	34,5	30	25,7	22	18,7		48
52						33,5	33,5	29,5	25,3	21,6	18,7					34,5	32,5	28,5	24,6	21,1	18		52
56						25,8	30	28	24,2	20,7	18					27,7	30,5	27	23,6	20,3	17,3		56
60							25,7	26,4	23,2	19,9	17,4						27,7	25,5	22,6	19,6	16,6		60
64							19,8	23,9	22,2	19,2	16,7						21,6	24	21,7	18,9	16		64
68								19,2	21,4	18,5	16,1							20,8	20,8	18,1	15,4		68
72									18,9	17,8	15,5								19,9	17,4	14,8		72
76										15,2	17,2	15							16,1	16,7	14,2		76
80											14,7	14,4								15,6	13,6		80
84											11,6	13,9								12,3	13		84
88												10,8									11,6		88

TAB 50038.1

m	42 m											49 m											m	
	21 m	28 m	35 m	42 m	49 m	56 m	63 m	70 m	77 m	84 m	91 m	21 m	28 m	35 m	42 m	49 m	56 m	63 m	70 m	77 m	84 m	91 m		
14	120	106										114	100										14	
16	115	103	96									108	96	86									16	
18	110	100	92	79								103	93	83	72								18	
20	105	96	88	76	65							98	89	80	70	60							20	
22	102	93	85	74	63	55						95	86	77	68	58	51						22	
24	91	89	82	71	61	53	45	37				92	83	74	65	56	49	41,5	33,5				24	
26		86	78	69	59	52	44	36,5	30,5			80	71	63	54	47,5	40,5	33	27,2				26	
28		82	75	67	57	50	43	36	30	25		77	68	61	52	46	39,5	32,5	27,2	22,5			28	
30		73	73	65	56	49	42	35	29,5	24,7	21,5	74	66	59	51	45	38,5	32	26,7	22	18,7		30	
32			56	69	62	54	47,5	41	34,5	29	24,4	21	59	64	57	49,5	44	38	31,5	26,3	21,7	18,2	32	
34				63	60	52	46,5	40	33,5	28,5	24	20,6		62	55	48	43	37	31	25,8	21,3	17,8	34	
36				59	58	50	45	39	33	28	23,6	20,2		60	53	46,5	41,5	36	30,5	25,4	20,9	17,5	36	
38				50	54	49	43,5	38	32,5	27,5	23,2	19,8		53	51	45,5	40,5	35	29,8	25	20,6	17,1	38	
40					50	47	42	37	31,5	27	22,8	19,5			50	44	39	34	29	24,5	20,2	16,8	40	
44					39	43,5	39,5	35	30	26	22,2	18,7			40	41,5	37	32	27,7	23,7	19,6	16,1	44	
48						38,5	37	33	29	25,2	21,5	18				39	34,5	30,5	26,6	22,9	18,9	15,5	48	
52							34,5	31	27,5	24,2	20,7	17,3				29,5	32,5	28,8	25,2	22	18,2	14,9	52	
56							28,8	29	26	23,2	20	16,6					29,8	27	24	21,1	17,6	14,3	56	
60								27,5	24,5	22,3	19,3	15,9						25,4	22,6	20,3	17	13,8	60	
64								22,6	23,3	21,4	18,6	15,3						23,5	21,4	19,5	16,4	13,2	64	
68									21,7	20,4	17,8	14,6							20,2	18,6	15,7	12,8	68	
72										19,4	17,1	14							18,7	17,7	15,1	12,3	72	
76											16,9	16,3	13,5							17	14,5	11,8	76	
80												15,6	13								14	11,4	80	
84												13	12,5									13,4	11	84
88													12										10,6	88

TAB 50038.2

Der LR 1550 hat für jeden Einsatz die passende Ausrüstung.



87°
56 m -
77 m



21 m -
91 m



8,8 m x
8,5 m



360°



160 t



30 t

m	56 m											63 m											m
	21 m	28 m	35 m	42 m	49 m	56 m	63 m	70 m	77 m	84 m	91 m	28 m	35 m	42 m	49 m	56 m	63 m	70 m	77 m	84 m	91 m		
14	105											79										14	
16	100	88	76									76	66	57								16	
18	96	85	73	64								73	64	55	47							18	
20	92	82	71	63	54							70	61	53	46	40						20	
22	89	79	68	61	52	46						67	59	52	45	39	33					22	
24	86	76	66	59	51	44,5	38,5					65	57	50	43,5	38	32,5	28,5				24	
26		68	73	64	57	49,5	43,5	37,5	30	25		62	55	49	42,5	37	32	28	24	18		26	
28			71	61	55	48	42,5	36,5	29,5	24,4	20	60	53	47,5	41,5	36	31,5	27,5	23,5	17,5		28	
30				68	59	54	46,5	41,5	35,5	29	24	58	51	46	40,5	35,5	30,5	27	23,1	17,2	14,2	30	
32					63	57	52	45	40,5	35	28,7	58	51	46	40,5	35,5	30,5	27	23,1	17,2	14,2	32	
34						56	50	44	39,5	34	28,3	49	44,5	39,5	34,5	30	26,5	22,7	17	13,9		34	
36						54	49	43	38,5	33,5	27,7	47,5	43	38	33,5	29,5	26	22,3	16,8	13,6		36	
38							53	47,5	42	37,5	32,5	46	41,5	37	32,5	28,8	25,5	21,9	16,5	13,4		38	
40								46	41	36,5	31,5	40	36	32	28,2	25	21,5	16,2	13,2			40	
44									41	39,5	34,5	38	34	30,5	27	24	20,7	15,6	12,7			44	
48										37	32,5	28,4	24,2	20,6	16,4	13,4						48	
52											30,5	26,6	23	19,8	15,8	12,9	29,8	27	24,4	21,8	19,2	14,6	52
56												28,5	25	22	19	15,3	25,5	23	20,8	18,4	14	11,3	56
60																							60
64																							64
68																							68
72																							72
76																							76
80																							80
84																							84
88																							88
92																							92

TAB 50038.3

m	70 m											77 m											m
	28 m	35 m	42 m	49 m	56 m	63 m	70 m	77 m	84 m	91 m	28 m	35 m	42 m	49 m	56 m	63 m	70 m	77 m	84 m	91 m			
16	71																					16	
18	68	61																				18	
20	66	58	49																			20	
22	63	56	48	43	37,5																	22	
24	61	54	47	41,5	36,5	31																24	
26	59	52	45,5	40	35,5	30,5	25															26	
28	57	50	44	39	34,5	30	24,6	19,5														28	
30	55	48	43	38	33,5	29,5	24,2	19,2	15,6													30	
32	53	47	42	37	33	28,8	23,8	18,9	15,4	12,8												32	
34		45	41	36	32	28,2	23,2	18,6	15,1	12,6	46	40	36	32	27,8	23,8	19,8	15,8	13,1	10,6		34	
36			44	40	35	31	27,6	22,8	18,3	14,9	12,4	39	35	31	27,2	23,2	19,4	15,6	12,9	10,4		36	
38				42	39	34	30,5	26,9	22,4	18	14,6	12,2	38	34	30,5	26,6	22,8	19	15,3	12,7	10,2	38	
40					40	38	33	30	26,3	22	17,8	14,4	12	37	33	29,5	26	22,2	18,6	15,1	12,5	10	40
44						35,5	31,5	28,4	25,1	21	17,2	13,9	11,6		31,5	28	24,8	21,2	18	14,6	12,1	9,6	44
48							30	26,8	23,9	20	16,6	13,5	11,2		26,5	23,4	20,2	17,2	14	11,7	9,3	48	
52							28,5	25,4	22,7	19,2	16	13	10,8		25	22,2	19,2	16,4	13,5	11,3	9	52	
56								24	21,6	18,4	15,4	12,5	10,4			21,1	18,2	15,6	13	10,9	8,6	56	
60									20,5	17,6	14,8	12	10			20	17,2	14,8	12,5	10,5	8,2	60	
64									19,5	16,8	14,2	11,5	9,6				16,2	14	12	10,1	7,9	64	
68										16	13,7	11	9,2						13,4	11,5	9,7	7,6	68
72											15,2	13,1	10,5	8,8					12,6	11	9,3	7,2	72
76												12,5	10	8,4						10,5	8,9	6,9	76
80													9,5	8						10	8,5	6,6	80
84														9	7,6						8,1	6,2	84
88																						5,8	88
92																						5,4	92

TAB 50038.4

Die Hubhöhen am LN-Auslegersystem. Lifting heights at LN boom/jib combination. Hauteurs de levage en configuration LN.

LR1550

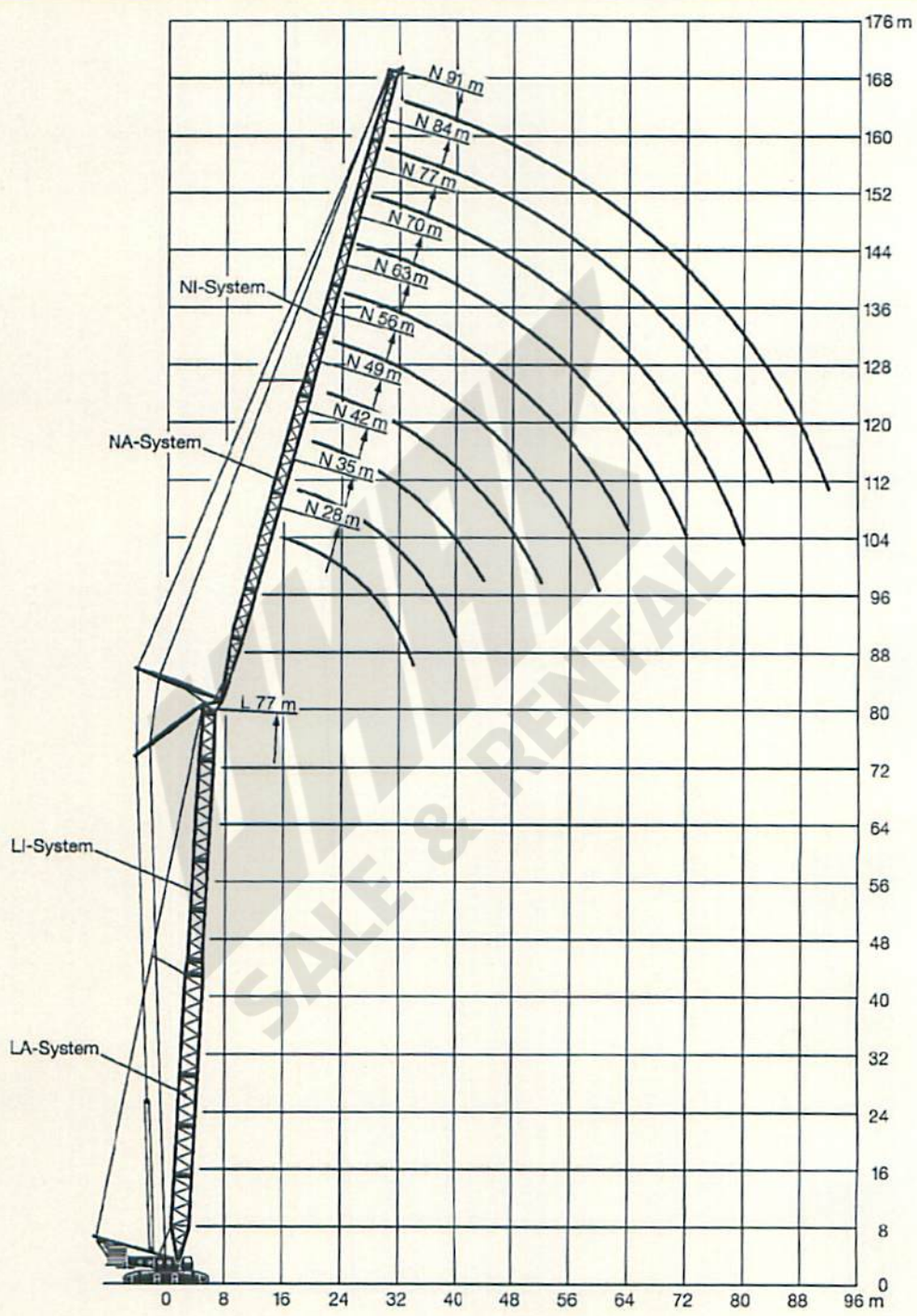

L-Ausleger / L boom / Flèche principale L: 87°

Die Traglasten am LN-Auslegersystem. Lifting capacities at LN boom/jib combination. Forces de levage en configuration LN.

LR 1550



67°
28 m -
77 m



21 m -
91 m



8,8 m x
8,5 m



360°



200 t



30 t

m	28 m											35 m											m
	21 m	28 m	35 m	42 m	49 m	56 m	63 m	70 m	77 m	84 m	91 m	21 m	28 m	35 m	42 m	49 m	56 m	63 m	70 m	77 m	84 m	91 m	
28	91																						28
30	83											81											30
32	77	76										75											32
34	71	71										69	69										34
36		66	65									65	64										36
38		62	61	61								61	60	59									38
40		58	58	57								56	56	56									40
44			51	51	50							50	49,5	49									44
48			46	45,5	45	44,5						44,5	44	43,5									48
52				41	40,5	40	39,5					40,5	40	39,5	39								52
56					35,5	37	36,5	36	32,5					36,5	36	35,5	35	30,5					56
60						34	33,5	33	31,5	26,5					33	32,5	32	29,9	24,9				60
64							31	30,5	30	25,9	21,8				30,5	29,9	29,4	28,9	24,4	20,4			64
68							28,7	28,1	27,2	25,2	21,3	17,6				27,6	27,1	26,7	23,9	20	16,2		68
72								25,9	24,8	24,3	20,8	17				25,7	25,1	24,7	23,4	19,5	15,9		72
76								23,6	22,7	22,2	20,2	16,5					23,4	22,9	22,3	19,1	15,5		76
80									20,8	20,3	19,7	15,9					21,9	21,4	20,7	18,7	15,1		80
84									16,9	16,6	16,4	15,3					20	19,3	18,3	14,8			84
88										17,1	16,9	14,8						18	17,6	14,4			88
92											15,5	14,3							16,9	16,3	14		92
96												14,2	13,5							15	13,7		96
100													12,3							13,7	13		100
104														11,2							11,9		104

TAB 50045.1

m	42 m											49 m											m	
	21 m	28 m	35 m	42 m	49 m	56 m	63 m	70 m	77 m	84 m	91 m	21 m	28 m	35 m	42 m	49 m	56 m	63 m	70 m	77 m	84 m	91 m		
32	73																						32	
34	68																						34	
36	63	62											61										36	
38	59	58											57										38	
40	55	55	54										53										40	
44		48,5	48	47,5									47	46,5									44	
48		44	43	42,5	42								42	41,5	41								48	
52			39	38,5	38	37,5								37,5	37	36,5							52	
56				35,5	34,5	34,5	33,5							34,5	34	33	33						56	
60					32,5	32	31,5	30,5	28,4						31	30,5	30	29,5					60	
64						29,3	28,9	28,1	27,7	22,9					28,6	28	27,6	27,1	25,8				64	
68						27,2	26,7	26	25,5	22,5	18,7					25,5	25	23,8	21,2				68	
72							24,8	24,1	23,6	22,1	18,4	14,8					23,7	23,1	22	20,7	17,1		72	
76								22,4	21,9	21	18,1	14,6					22	21,4	20,3	19,6	16,8	13,4	76	
80									20,9	20,4	19,4	17,8	14,4					20	18,9	18,1	16,4	13,2	80	
84										19,1	18,1	17,4	14,2					18,7	17,6	16,8	15,8	12,9	84	
88										17,8	16,9	16,2	14						16,4	15,7	14,7	12,6	88	
92											15,8	15,1	13,8						15,5	14,6	13,6	12,4	92	
96											14,9	14,1	13,1							13,6	12,6	11,7	96	
100													13,2	12,2							11,8	10,8	100	
104														11,4							11	10	104	
108																						9,3	108	
112																							8,7	112

TAB 50045.2

67°
56 m -
77 m21 m -
91 m8,8 m x
8,5 m

360°



160 t



30 t

m	56 m											63 m											m
	21 m	28 m	35 m	42 m	49 m	56 m	63 m	70 m	77 m	84 m	91 m	28 m	35 m	42 m	49 m	56 m	63 m	70 m	77 m	84 m	91 m		
38	55																					38	
40	52																					40	
44	46	45,5																				44	
48		40,5	40									39										48	
52		37	36,5	36								35,5	35	33,5								52	
56			33	32,5	32							32	32	30,5	29,7							56	
60			30,5	29,8	29,3	28,4							29,1	28,1	27,1	26,4						60	
64				27,5	27	26	25,2							25,8	24,9	24,2	22,2					64	
68					24,9	24	23,1	22						23,9	23	22,3	21	18				68	
72					23,1	22,2	21,3	20,2	19,4						21,3	20,6	19,3	17,4	15,3			72	
76						20,7	19,8	18,6	17,9	15,6					19,9	19,1	17,8	16,7	14,7	12,1		76	
80						19,4	18,4	17,2	16,5	15,1	12,1					17,8	16,5	15,3	14,1	11,7	9,3	80	
84							17,2	16	15,3	14,2	11,8						15,4	14,2	13,4	11,2	9	84	
88							16,2	14,9	14,1	13,1	11,4						14,4	13,1	12,3	10,7	8,6	88	
92								13,9	13,1	12,1	11,1							12,2	11,4	10,3	8,2	92	
96									12,2	11,2	10,2							11,4	10,6	9,5	7,8	96	
100										11,4	10,3	9,3								9,8	8,7	7,5	100
104											9,6	8,6								9,2	8	7,2	104
108											9	7,8									7,4	6,8	108
112												7,4										6,4	112
116												7										5,9	116

TAB 50045.3

m	70 m											77 m											m
	28 m	35 m	42 m	49 m	56 m	63 m	70 m	77 m	84 m	91 m	28 m	35 m	42 m	49 m	56 m	63 m	70 m	77 m	84 m	91 m			
48	36																					48	
52	33	32																				52	
56	30,5	29,5	28,4																			56	
60		27	26	24,5																		60	
64		24,9	23,9	22,6	20																	64	
68			22	20,8	18,8	16,5																68	
72				20,5	19,1	17,5	15,6	13,4														72	
76					17,4	16,3	14,7	12,7	10,7													76	
80					15,6	15	13,8	11,9	10,1	8,4												80	
84						13,7	12,9	11,2	9,5	7,9	6,3											84	
88							12	10,5	8,9	7,5	5,9											88	
92							11,2	9,8	8,3	7	5,5											92	
96								9,1	7,7	6,5	5,1											96	
100								8,4	7,1	6	4,8											100	
104									6,5	5,5	4,4											104	
108										5	4											108	
112											3,6											112	
116												3,3										116	
120													3									120	

TAB 50045.4

**The LR 1550 can be equipped
to tackle any job.**

Die Hubhöhen am LN-Auslegersystem. Lifting heights at LN boom/jib combination. Hauteurs de levage en configuration LN.

LR1550

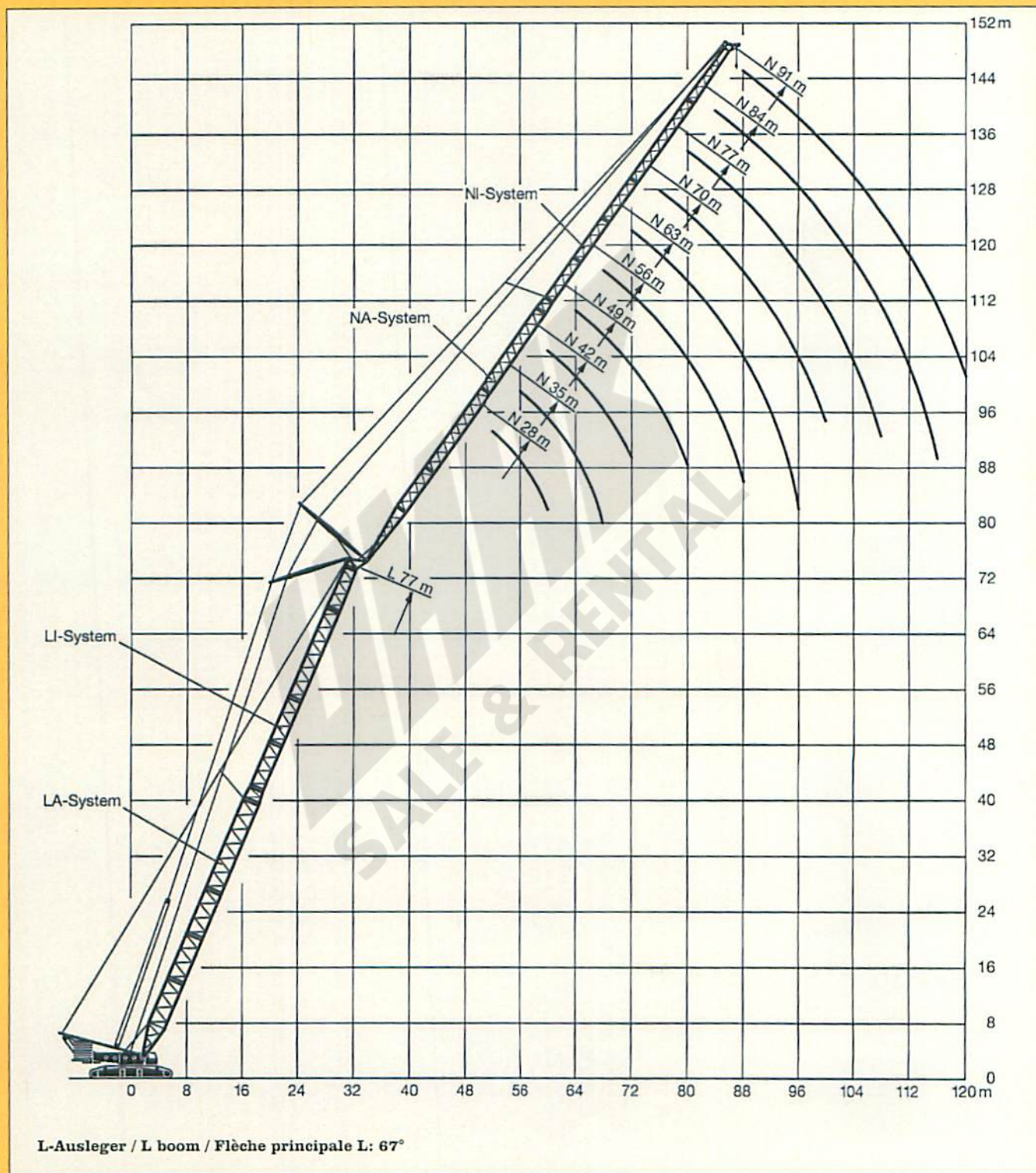

Die Auslegersysteme. Boom/jib combinations. Configurations de flèche.

LR1550

Schwere Ausführung.
Heavy weight design.
Conception lourde.

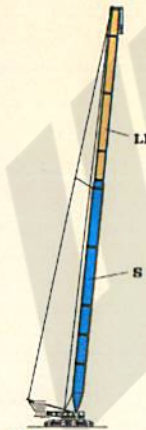

SL 21 m - 98 m



SLD 35 m - 91 m

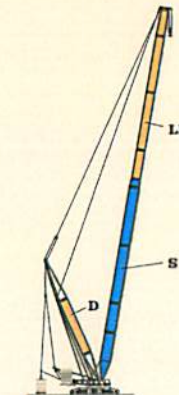

SLDB 35 m - 91 m

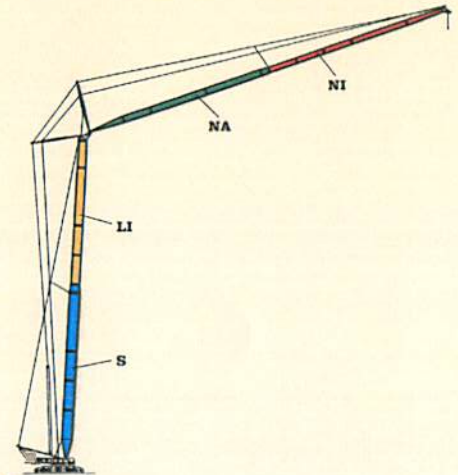

SLN 28 m - 77 m / 21 m - 91 m



SD 35 m - 105 m

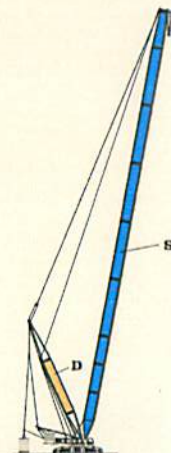

SDB 35 m - 105 m

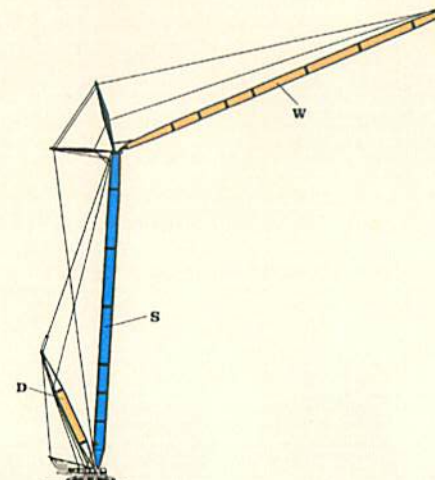

SDW 35 m - 77 m / 28 m - 84 m

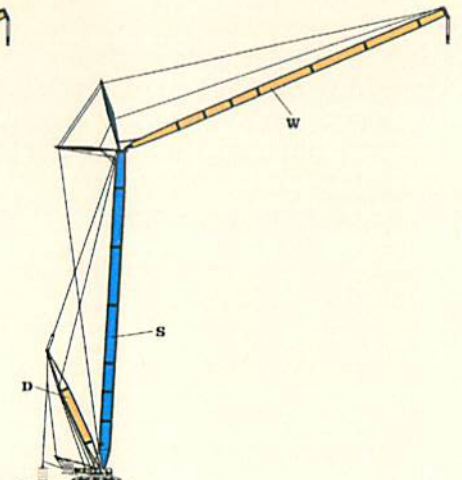

SDWB 35 m - 77 m / 28 m - 84 m

- S** Hauptausleger, schwer
Main boom, heavy
Flèche principale, lourde
- L** Hauptausleger, leicht
Main boom, light
Flèche principale, légère
- N** Nadelausleger, leicht
Luffing jib, light
Fléchette, légère
- W** Wippausleger, schwer
Luffing jib, heavy
Fléchette, lourde
- D** Derricksausleger
Derrick
Flèche derrick
- B** Schwebeballast
Suspended ballast
Lest suspendu

La LR 1550 possède l'équipement
qui convient à chaque problème.

Die Traglasten am SL-Ausleger. Lifting capacities at SL boom. Forces de levage à la flèche principale SL.

LR1550



21 m - 98 m



8,8 m x 8,5 m



360°



200 t

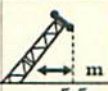

90 t

 m	21 m	28 m	35 m	42 m	49 m	56 m	63 m	70 m	77 m	84 m	91 m	98 m	 m	
5,5	480	400											5,5	
6	448	380	370										6	
6,5	416	365	360										6,5	
7	388	350	350	338									7	
8	342	340	339	330	300								8	
9	306	304	302	300	283	250	215						9	
10	276	274	272	270	270	239	206	179	152				10	
11	251	249	248	246	245	228	196	169	145	132	120		11	
12	230	229	227	225	224	219	187	160	139	127	116	106	12	
14	197	196	194	192	191	191	170	146	127	116	108	98	14	
16	172	170	169	167	166	166	154	133	117	108	99	90	16	
18	152	151	149	147	146	146	140	122	107	100	92	84	18	
20	135	134	132	130	130	129	127	112	98	94	86	79	20	
22		120	118	116	116	116	115	103	91	88	81	74	22	
24		108	107	105	104	104	103	94	84	83	76	69	24	
26		99	97	95	95	94	94	87	78	77	71	65	26	
28			89	87	87	86	85	79	72	71	67	60	28	
30			82	80	79	79	78	72	67	66	63	57	30	
32			76	74	73	73	72	66	62	61	59	53	32	
34				68	68	67	67	61	58	57	56	49	34	
36				64	63	62	62	57	55	54	53	46	36	
38				59	59	58	57	53	51	50	50	43	38	
40					55	54	54	50	48	48	47	41	40	
44					48	47,5	46,5	44	42	41,5	39,5	36	44	
48						41,5	41	38	37	35,5	33,5	31,5	48	
52							36	33	32	30,5	28,4	26,1	52	
56								31	28,9	27,6	26,1	24	56	
60									25,3	23,9	22,4	20,2	60	
64										20,7	19,2	16,9	64	
68											17,8	16,4	68	
72												13,9	72	
76													76	
80													80	
m/s*	14			13				11				9		m/s*

Traglasten über 450 t nur mit Zusatzeinrichtung.
Lifting capacities above 450 t only with special equipment.
Forces de levage plus de 450 t seulement avec équipement spécial.

TAB 50029

* Zulässige Windgeschwindigkeit.
Permissible wind speed.
Vitesse du vent admissible.

Die Hubhöhen am SL-Ausleger.

Lifting heights at SL boom.

Hauteurs de levage à la flèche principale SL.

LR1550

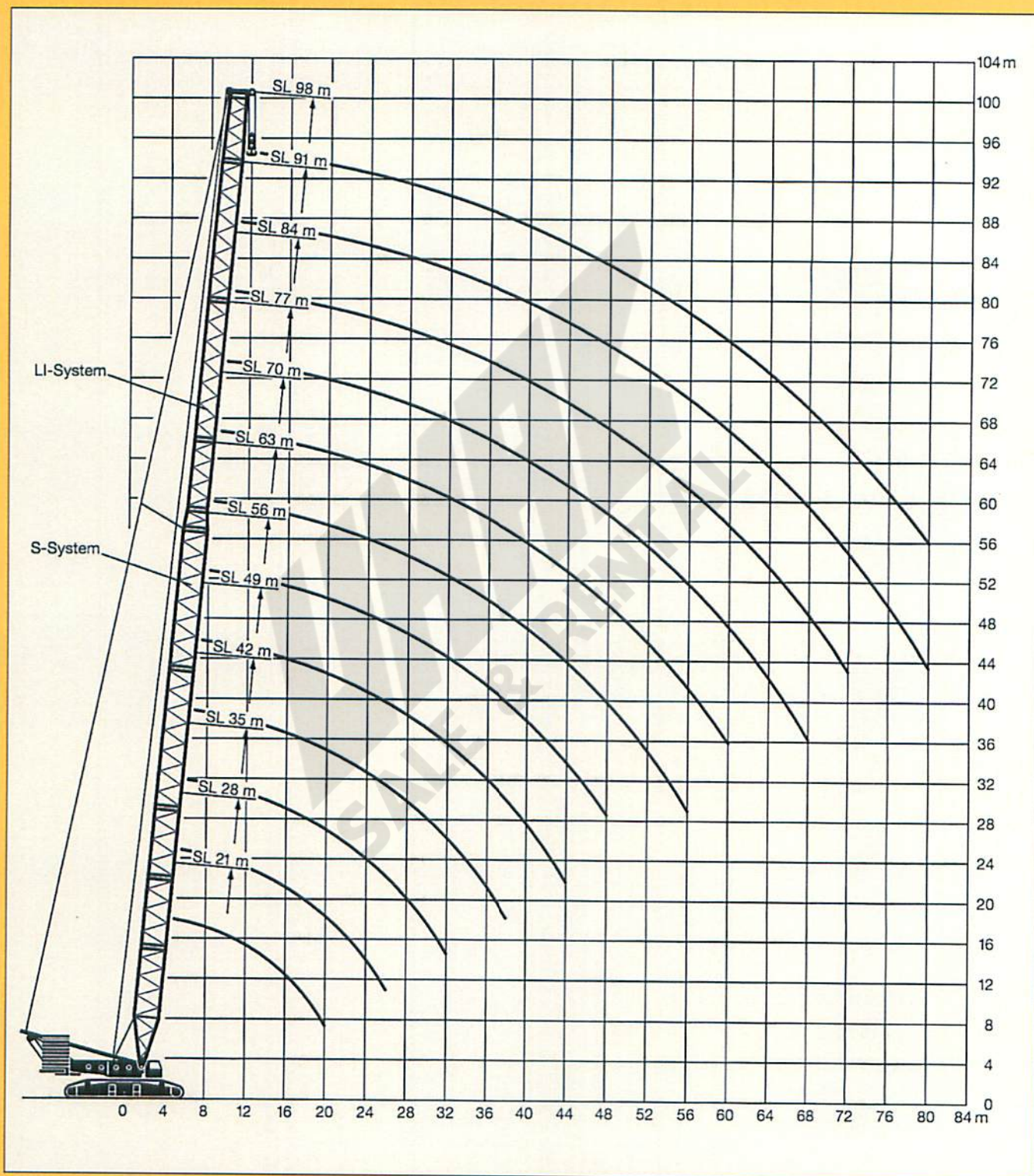

Die Traglasten am SLD-Auslegersystem. Lifting capacities at SLD boom/derrick combination. Forces de levage en configuration SLD.



35 m -
91 m



31,5 m



8,8 m x
8,5 m





360°



160 t



90 t

 m	35 m	42 m	49 m	56 m	63 m	70 m	77 m	84 m	91 m	 m
9	307									9
10	277	274								10
11	252	249								11
12	230	228	227	227						12
14	197	194	193	193	192					14
16	171	169	168	167	167	165	164			16
18	151	148	148	147	147	145	144	142	136	18
20	135	132	131	131	130	129	128	127	121	20
22	121	118	118	117	117	115	114	114	109	22
24	109	107	106	105	105	103	103	102	99	24
26	99	97	96	96	95	93	93	92	90	26
28	91	88	87	87	87	85	84	83	82	28
30	84	81	80	80	79	77	77	76	74	30
32	77	75	74	73	73	71	70	69	67	32
34		69	68	68	67	65	64	63	62	34
36		65	63	63	62	60	59	58	56	36
38		60	59	59	58	56	54	53	52	38
40			55	55	54	52	50	49	47,5	40
44			49	48	47	44,5	43	42	40	44
48				42,5	41	38,5	37	36	34	48
52					36	33,5	32	31	28,7	52
56					32	29,3	27,6	26,4	24,3	56
60						25,7	23,9	22,7	20,4	60
64							20,8	19,4	17	64
68							18,1	16,6	14,1	68
72								14,2	10	72
m/s*	14			13			11		9	m/s*

* Zulässige Windgeschwindigkeit.
Permissible wind speed.
Vitesse du vent admissible.

TAB 50078

Die Hubhöhen am SLD-Auslegersystem. Lifting heights at SLD boom/derrick combination. Hauteurs de levage en configuration SLD.

LR 1550

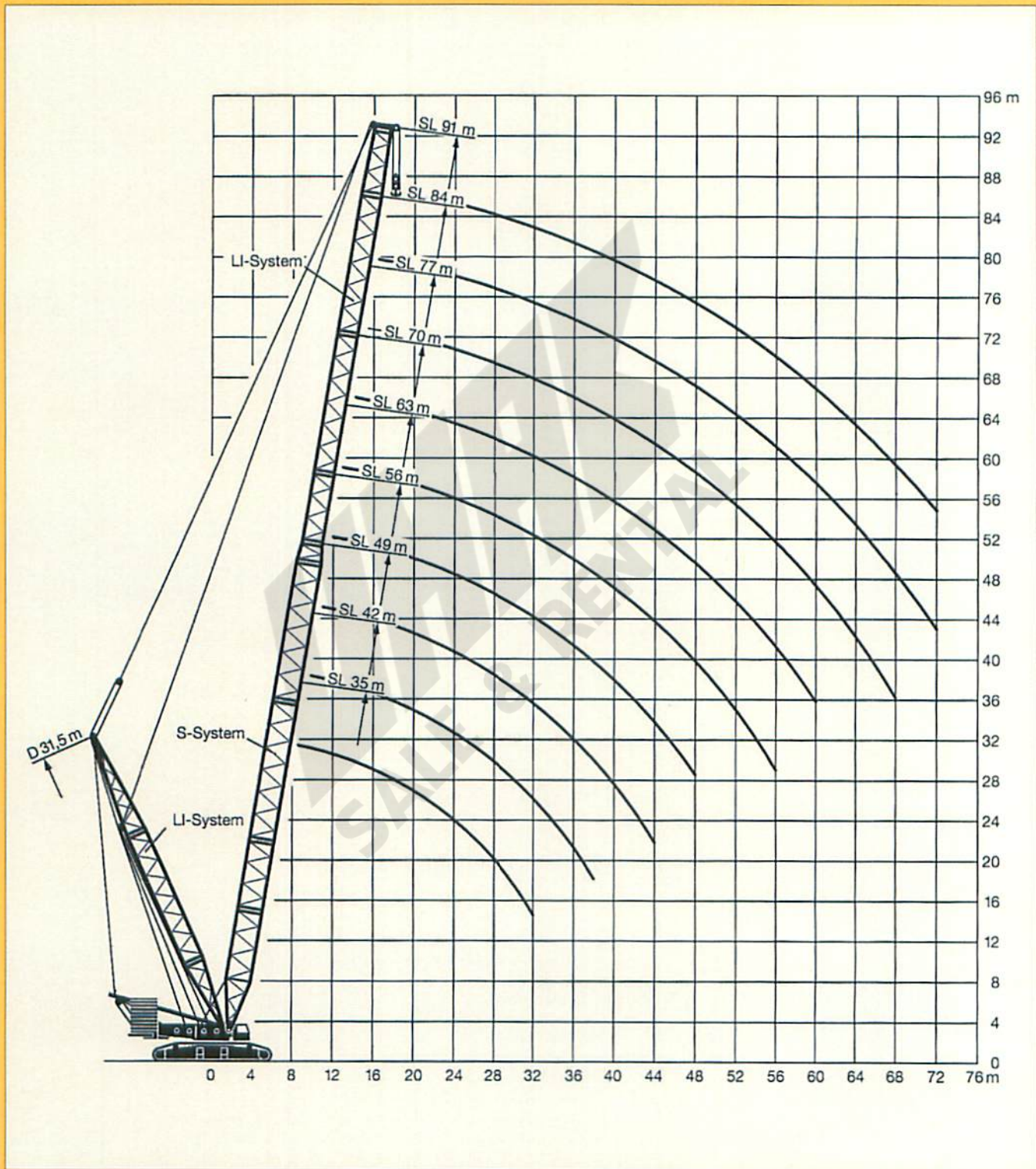

Die Traglasten am SLDB-Auslegersystem.

LR1550

Lifting capacities at SLDB boom/derrick combination. Forces de levage en configuration SLDB.



35 m -
91 m



31,5 m



8,8 m x
8,5 m



360°



160 t



250 t



30 t

	35 m	42 m	49 m	56 m	63 m	70 m	77 m	84 m	91 m		
9	410									9	
10	390	350								10	
11	370	345								11	
12	360	340	325	277						12	
14	350	335	320	274	229					14	
16	336	319	306	272	225	214	195			16	
18	302	298	285	270	220	208	192	167	136	18	
20	266	265	264	260	216	202	189	160	131	20	
22	238	237	236	235	212	196	182	154	126	22	
24	214	213	212	211	207	190	175	148	120	24	
26	195	193	192	191	190	184	167	141	115	26	
28	178	177	176	176	175	174	160	135	110	28	
30	164	163	162	162	161	160	152	128	104	30	
32	152	150	149	148	147	146	145	122	99	32	
34		139	138	138	137	136	135	116	94	34	
36		129	128	128	127	126	125	109	88	36	
38		121	120	120	119	118	117	103	83	38	
40			112	112	111	110	109	98	78	40	
44			100	99	98	97	96	88	67	44	
48				89	88	86	85	80	60	48	
52					79	77	76	72	53	52	
56					71	69	68	63	46	56	
60						62	61	55	39	60	
64							56	46	29	64	
68							51	36	20	68	
72								27	10	72	
m/s*	14		13			11			9		m/s*

* Zulässige Windgeschwindigkeit.
Permissible wind speed.
Vitesse du vent admissible.

TAB 50048

Die Hubhöhen am SLDB-Auslegersystem. Lifting heights at SLDB boom/derrick combination. Hauteurs de levage en configuration SLDB.

LR1550

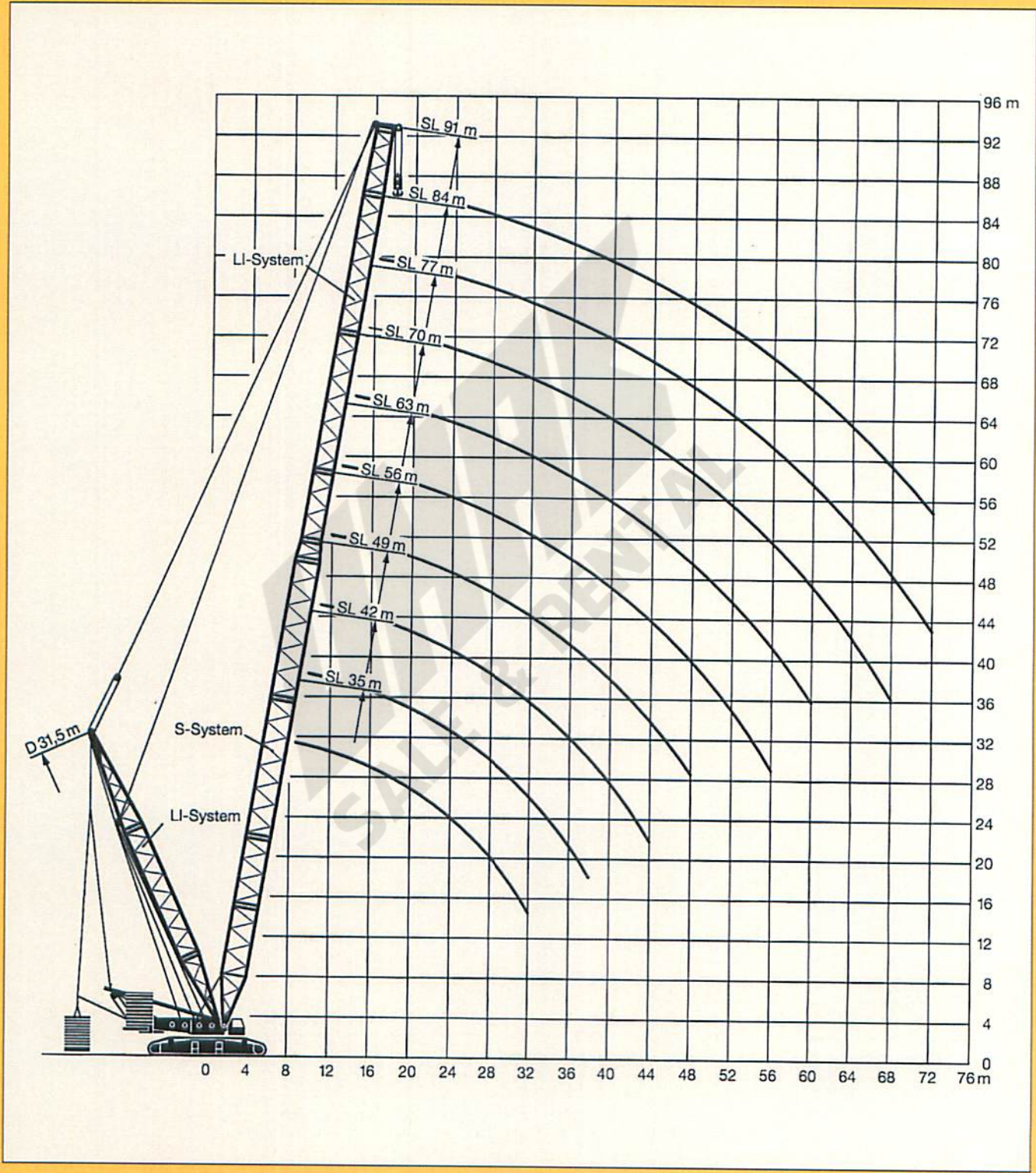

Die Traglasten am SLN-Auslegersystem. Lifting capacities at SLN boom/jib combination. Forces de levage en configuration SLN.

LR 1550



87°
28 m -
77 m



21 m -
91 m



8,8 m x
8,5 m



360°



160 t



30 t

m	28 m										35 m										m		
	21 m	28 m	35 m	42 m	49 m	56 m	63 m	70 m	77 m	84 m	91 m	21 m	28 m	35 m	42 m	49 m	56 m	63 m	70 m	77 m		84 m	91 m
12	130											130	122										12
14	130	128										129	118	111	93								14
16	130	124	118	98								125	114	106	91	78							16
18	130	120	111	96	81							121	110	102	89	76	65						18
20	126	116	107	93	79	66						113	107	98	86	74	63	54					20
22	108	110	104	91	77	64	56					85	100	94	84	72	61	53	43				22
24	78	98	97	88	75	63	54	44				90	99	81	70	60	51	42,5	34				24
26		88	87	86	73	61	53	43	34,5			81	81	79	68	58	50	41,5	33,5	28,6			26
28		80	79	79	71	60	52	42,5	34	29		69	74	73	66	57	49	40,5	32,5	28	23,8		28
30		65	72	72	69	58	50	41,5	33	28,3	24,6												30
32			67	66	66	57	49	40,5	32	27,7	24												32
34			61	61	61	55	48	39,5	31,5	27	23,5												34
36			54	56	57	54	47	38,5	30,5	28,3	22,9												36
38			43,5	52	53	52	45,5	37,5	29,8	25,7	22,3												38
40				48	49,5	48,5	44,5	37	29,1	25	21,7												40
44				34,5	43,5	42,5	42,5	35	27,8	23,9	20,6												44
48					35	38	37,5	33,5	28,6	22,7	19,7												48
52						33,5	33,5	32	25,7	21,6	18,9												52
56						25,8	30	29,3	24,7	21	18												56
60							25,7	26,4	24	20,3	17,5												60
64							19,8	23,9	23,2	19,7	16,9												64
68								19,2	21,5	19	16,4												68
72									18,9	18,5	15,8												72
76										15,2	17,8	15,4											76
80											14,7	14,9											80
84											11,4	13,9											84
88												10,8											88

TAB 50055.1

m	42 m										49 m										m		
	21 m	28 m	35 m	42 m	49 m	56 m	63 m	70 m	77 m	84 m	91 m	21 m	28 m	35 m	42 m	49 m	56 m	63 m	70 m	77 m		84 m	91 m
14	125	115										119	109										14
16	122	112	104									117	106	97									16
18	118	108	100	86								114	104	93	81								18
20	115	105	96	84	73							112	101	90	79	68							20
22	110	102	92	82	71	62						106	98	86	76	66	57						22
24	91	97	89	79	69	60	51	42				96	94	83	74	64	55	47	39				24
26		90	85	77	67	59	50	41,5	33,5			87	80	72	63	54	46	38,5	31				26
28		83	81	75	66	57	48,5	40,5	33	28,2		81	78	70	61	53	44,5	37,5	30,5	26,3			28
30		73	75	73	64	56	47	40	32,5	27,7	23	76	73	68	59	51	43,5	36,5	29,7	25,6	21,5		30
32		56	69	68	62	54	46	39	32	27,2	22,5	59	69	66	58	50	42,5	36	29,1	25,1	21		32
34			63	62	60	52	45	38	31,5	26,6	22												34
36			59	58	58	51	43,5	37,5	31	26,1	21,5												36
38				50	54	53	49,5	42,5	36,5	30	25,6	21											38
40					50	50	48	41,5	36	29,7	25	20,5											40
44					39	43,5	44	39,5	34	28,7	24	19,6											44
48						38,5	39	37,5	32,5	27,7	23,1	18,7											48
52							34,5	34,5	31	26,8	22,1	17,7											52
56							28,8	31	29,9	25,9	21,2	16,8											56
60								28	27,2	25	20,4	16,2											60
64								22,6	24,6	24,1	19,7	15,7											64
68									21,7	22,5	18,9	15,1											68
72										20,4	18,3	14,5											72
76										16,9	17,7	14,1											76
80											16,2	13,8											80
84											13	13,4											84
88												12,2											88

TAB 50055.2

The LR 1550 can be equipped to tackle any job.



87°
56 m -
77 m



21 m -
91 m



8,8 m x
8,5 m



360°



160 t



30 t

m	56 m										63 m										m		
	21 m	28 m	35 m	42 m	49 m	56 m	63 m	70 m	77 m	84 m	91 m	28 m	35 m	42 m	49 m	56 m	63 m	70 m	77 m	84 m		91 m	
14	113											92										14	
16	111	101	90																				16
18	110	99	87	75								89	79	70									18
20	109	97	83	73	62							87	77	68	58								20
22	102	94	80	71	61	52						85	74	66	57	49							22
24	95	91	77	68	59	51	43					83	72	63	55	47,5	40,5						24
26	88	84	75	66	58	49,5	42	35	28,6			81	70	62	54	46,5	39,5	33,5					26
28		79	73	65	56	48	40,5	34,5	27,8	24,3		78	68	60	52	45	38,5	32,5	26,3	22,9			28
30		74	71	63	55	47	40	33,5	27	23,5	20	72	66	58	51	44	37,5	31,5	25,6	22,3			30
32		63	67	61	53	46	39	33	26,4	22,9	19,4	68	64	57	49,5	43	36,5	31	25,1	21,8	18,4		32
34			64	60	52	45	38	32	25,9	22,3	18,8		62	55	48	42	36	30	24,6	21,3	18		34
36			60	58	51	44	37,5	31,5	25,4	21,8	18,3		59	54	47	41	35	29,6	24,1	20,8	17,6		36
38			55	55	49,5	43,5	36,5	31	24,9	21,4	17,8		56	53	46	40	34,5	28,9	23,6	20,4	17,2		38
40				51	48,5	42,5	36	30,5	24,5	21	17,4			51	44,5	39	33,5	28,3	23,1	20	16,8		40
44				41	45	41	35	29,3	23,7	20,2	16,6			43,5	42,5	37,5	32,5	27,3	22,3	19,3	16,1		44
48					39,5	39	33,5	28,3	23	19,5	15,9				40,5	35,5	31	26,3	21,6	18,6	15,5		48
52					30,5	35	32,5	27,4	22,4	18,8	15,3				32,5	34	29,9	25,4	20,9	17,9	14,9		52
56						30,5	31,5	26,6	21,9	18,3	14,8					32	28,7	24,5	20,2	17,3	14,4		56
60							28,1	25,7	21,3	17,9	14,4						27,5	23,6	19,5	16,7	13,9		60
64							24,2	24,7	20,7	17,4	14,1						24,1	22,8	19	16,2	13,4		64
68								22,4	20,1	16,9	13,8							22	18,4	15,7	13		68
72								19,3	19,6	16,4	13,4							19,3	17,8	15,2	12,5		72
76									18,1	16	13,1								17,2	14,6	12,1		76
80										15,5	12,8									14,1	11,6		80
84										14,1	12,5									13,6	11,2		84
88											12,1										10,7		88
92											11,1										10,3		92

TAB 50055.3

m	70 m										77 m										m			
	28 m	35 m	42 m	49 m	56 m	63 m	70 m	77 m	84 m	91 m	28 m	35 m	42 m	49 m	56 m	63 m	70 m	77 m	84 m	91 m				
16	82											76											16	
18	80	72										73	65										18	
20	78	70	62									71	62	56									20	
22	76	68	60	53	46							69	60	54	48	41							22	
24	74	66	59	51	44,5	38						67	58	52	46	39,5	34,5						24	
26	72	64	57	49,5	43	37	31,5					65	57	50	44,5	38,5	33,5	27,9					26	
28	69	62	55	48	42	36	30,5	24,8				64	55	49	43,5	37,5	32,5	27,2	22,4				28	
30	67	60	54	46,5	41	35	29,8	24,3	21			63	54	48	42	36,5	31,5	26,5	21,8	18,6			30	
32	65	59	52	45,5	40	34	29	23,8	20,6	17,4		62	53	47	41	35,5	31	25,9	21,3	18,2	15,4		32	
34		57	51	44	38,5	33,5	28,3	23,3	20,2	17,1	14,5	60	52	46	40	35	30	25,3	20,8	17,7	15,1		34	
36		55	49	43	38	32,5	27,7	22,7	19,8	16,8			51	45	39	34	29,5	24,8	20,4	17,3	14,8		36	
38		54	48	42	37	32	27	22,2	19,4	16,5			50	44	38	33,5	28,9	24,2	20	16,9	14,5		38	
40		51	46,5	40,5	36	31,5	26,3	21,7	19	16,2			49	43	37	32,5	28,3	23,7	19,6	16,6	14,2		40	
44			43,5	38,5	34	29,8	25,3	20,9	18,3	15,6				41	35,5	31	27,2	22,8	18,8	15,9	13,6		44	
48				36,5	32,5	28,4	24,3	20,1	17,6	15					34	29,7	26,2	22	18,2	15,4	13,1		48	
52				33,5	31	27,2	23,3	19,4	17	14,5					32,5	28,5	25,2	21,2	17,6	14,8	12,6		52	
56					28,8	25,9	22,4	18,6	16,3	13,9						27,4	24,3	20,4	17	14,3	12		56	
60						24,7	21,5	17,8	15,6	13,4						26,2	23,3	19,6	16,4	13,7	11,5		60	
64						23,4	20,6	17,2	15	12,8							22,4	18,9	15,9	13,3	11		64	
68						19,7	16,6	14,5	12,2									18,3	15,4	12,8	10,6		68	
72							18,8	16	13,9	11,7								17,6	14,8	12,4	10,1		72	
76								15,4	13,3	11,1									14,3	11,9	9,7		76	
80									12,8	10,5										13,8	11,5	9,3		80
84									12,2	9,9										11	8,9		84	
88										9,4											8,4		88	
92										8,8											8		92	

TAB 50055.4

Die Hubhöhen am SLN-Auslegersystem. Lifting heights at SLN boom/jib combination. Hauteurs de levage en configuration SLN.

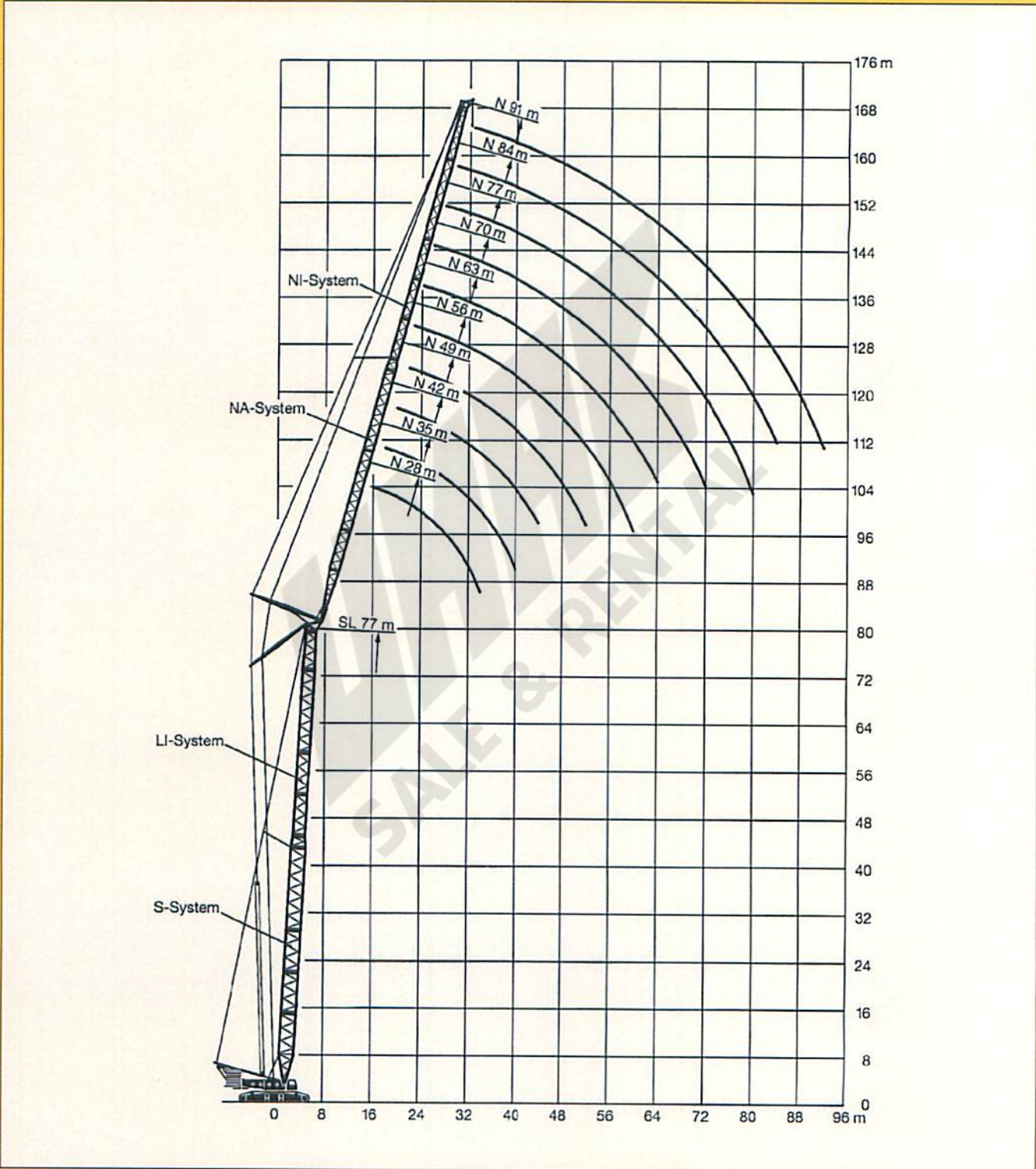

Die Traglasten am SLN-Auslegersystem. Lifting capacities at SLN boom/jib combination. Forces de levage en configuration SLN.

LR 1550



67°
28 m -
77 m



21 m -
91 m



8,8 m x
8,5 m



360°



200 t



30 t

m	28 m										35 m										m		
	21 m	28 m	35 m	42 m	49 m	56 m	63 m	70 m	77 m	84 m	91 m	21 m	28 m	35 m	42 m	49 m	56 m	63 m	70 m	77 m		84 m	91 m
28	91											81										28	
30	83																					30	
32	77	76										74										32	
34	71	71										69	68									34	
36		66	65									64	64									36	
38		62	61	61								60	60	59								38	
40		58	58	57								56	56									40	
44			51	51	50							50	49,5	49								44	
48			46	45,5	45	44,5							44,5	44	43							48	
52				41	40,5	40	39,5						40,5	39,5	39	38,5						52	
56				35,5	37	36,5	36	33						36	35,5	35	34,5	32				56	
60					34	33,5	33	32	26,5						32,5	32,5	31,5	31	25			60	
64						31	30,5	30	26	21,8					30	29,7	29,2	28,8	24,5	20,4		64	
68						28,7	28,1	27,2	25,6	21,3	17,6					27,5	27	26,5	24	20	16,4	68	
72							25,9	24,8	24,3	20,8	17,1					25,6	25	24,5	23,6	19,6	16,1	72	
76							23,6	22,7	22,2	20,3	16,7						23,3	22,8	22,1	19,2	15,7	76	
80								20,8	20,3	19,8	16,2						21,7	21,2	20,6	18,8	15,4	80	
84								16,9	16,6	16,4	15,8							19,9	19,2	18,4	15,1	84	
88									17,1	16,9	16,3								17,9	17,4	14,8	88	
92										15,5	14,7								16,8	16,2	14,4	92	
96											14,2	13,5								15	14,1	96	
100												12,3								13,7	13	100	
104													11,2								13,7	11,9	104

TAB 50082.1

m	42 m										49 m										m			
	21 m	28 m	35 m	42 m	49 m	56 m	63 m	70 m	77 m	84 m	91 m	21 m	28 m	35 m	42 m	49 m	56 m	63 m	70 m	77 m		84 m	91 m	
32	72																					32		
34	67																					34		
36	62	61										60										36		
38	58	57										56										38		
40	55	54	53									53	52									40		
44		48	47,5	47									46	45,5								44		
48		43	42,5	42	41,5								41,5	41	40,5							48		
52			38,5	38	37,5	37								37	36,5	36						52		
56				34,5	34	34	33							34	33,5	32,5	32,5					56		
60					31,5	31	30	29,7							30,5	29,9	29,5	28,9				60		
64						28,9	28,5	27,7	27,3	23						28,1	27,6	27,2	26,5	25,3		64		
68						26,7	26,3	25,6	25,1	22,6	18,7						25,5	25,1	24,4	23,2	21,2	68		
72							23,7	23,2	22,1	18,4	15							23,3	22,5	21,4	20,7	17,2	72	
76							24,4	23,7	23,2	22,1	18,4	15						21,6	20,9	19,8	19,1	16,9	13,6	76
80								20,5	20	18,9	17,8	14,6							19,5	18,3	17,6	16,5	13,4	80
84									18,7	17,6	16,9	14,4							18,2	17,1	16,3	15,3	13,1	84
88									17,5	16,4	15,7	14,2								16	15,2	14,2	12,9	88
92										15,3	14,6	13,6								15	14,1	13,1	12,1	92
96										14,5	13,6	12,7									13,2	12,1	11,2	96
100											12,7	11,8										11,3	10,3	100
104												11										10,6	9,6	104
108													10,3										8,9	108
112																							8,3	112

TAB 50082.2



67°
56 m -
77 m



21 m -
91 m



8,8 m x
8,5 m



360°



200 t



30 t

m	56 m										63 m										m		
	21 m	28 m	35 m	42 m	49 m	56 m	63 m	70 m	77 m	84 m	91 m	28 m	35 m	42 m	49 m	56 m	63 m	70 m	77 m	84 m		91 m	
38	54																					38	
40	51																						40
44	45,5	44,5																					44
48		40	39,5									38,5											48
52		36,5	35									35	34	32,5									52
56			32,5	32	31,5							31,5	31	29,9	28,7								56
60			30	29,4	28,8	27,7							28,6	27,4	26,4	25,7							60
64				27	26,5	25,4	24,5							25,2	24,3	23,5	22,2						64
68					24,5	23,4	22,5	21,3						23,3	22,4	21,6	20,4	19,2					68
72					22,7	21,6	20,8	19,6	18,9					20,7	20	18,7	17,5	16,5					72
76						20,1	19,2	18,1	17,3	15,6				19,3	18,5	17,3	16,1	15,3	13,2				76
80						18,8	17,8	16,7	16	14,9	12,1			17,2	16	14,8	14	12,6	10,2				80
84							16,7	15,5	14,7	13,6	11,9				14,9	13,8	12,9	11,8	9,8				84
88							15,7	14,4	13,6	12,6	11,5				13,8	12,6	11,8	10,7	9,4				88
92								13,5	12,6	11,6	10,6						11,7	10,9	9,8	9			92
96									11,7	10,7	9,7						11	10,1	9	8,4			96
100									11	9,9	8,9							9,3	8,2	7,6			100
104										9,2	8,1							8,8	7,5	7			104
108										8,6	7,5								7	6,5			108
112											7									6			112
116											6,6												116

TAB 50062.3

m	70 m										77 m										m		
	28 m	35 m	42 m	49 m	56 m	63 m	70 m	77 m	84 m	91 m	28 m	35 m	42 m	49 m	56 m	63 m	70 m	77 m	84 m	91 m			
48	34,5																						48
52	31,5	30,5												28,6									52
56	29,2	28	26,8											26,4	25,4								56
60		25,9	24,8	23,3										24,5	23,5	21,9							60
64		23,8	22,8	21,5	20,8									21,7	20,3	19,4							64
68			21	19,7	19	17,7								20,1	18,6	17,7	16,6						68
72			19,5	18,2	17,5	16,2	15,4								17,2	16,3	15,2	14,3					72
76				16,9	16,1	14,8	14,1	12,6							15	13,9	13	11,7					76
80					14,9	13,6	12,8	11,6	10						13,9	12,8	11,9	10,6	9,3				80
84					13,9	12,6	11,8	10,5	9,3	7,7					11,8	10,9	9,6	8,1	7,2				84
88						11,6	10,8	9,6	8,4	7,2					11	10	8,7	7,1	6,6	5,4			88
92						10,9	10	8,7	7,3	6,7						9,2	7,7	6,5	6	5,1			92
96							9,2	7,8	6,7	6,1						8,6	7,1	6	5,4	4,5			96
100							8,4	7,1	6,2	5,6							6,6	5,5	5	4,1			100
104								6,5	5,7	5,1									5,1	4,5	3,6		104
108									5,2	4,6								4,8	4,1	3,2			108
112									4,5	4									3,8	2,9			112
116										3,5									3,5	2,6			116
120											3									2,3			120
124																					2,2		124

TAB 50062.4

**Die Hubhöhen am SLN-Auslegersystem.
Lifting heights at SLN boom/jib combination.
Hauteurs de levage en configuration SLN.**

LR1550

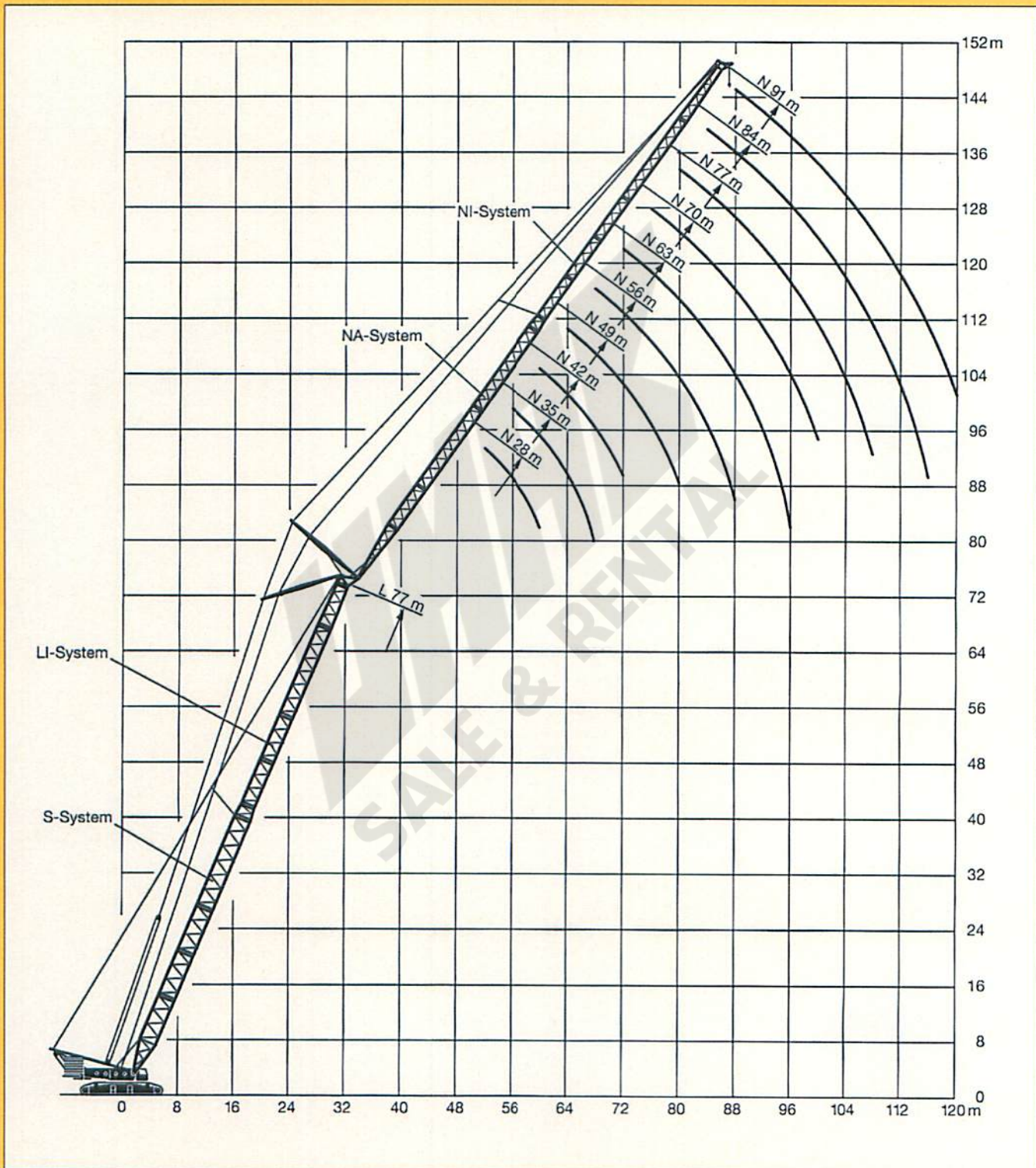

Die Traglasten am SD-Auslegersystem. Lifting capacities at SD boom/derrick combination. Forces de levage en configuration SD.

LR 1550



35 m -
105 m



31,5 m



8,8 m x
8,5 m





360°



200 t



90 t

 m	35 m	42 m	49 m	56 m	63 m	70 m	77 m	84 m	91 m	98 m	105 m	 m
9	304											9
10	273	271										10
11	248	246										11
12	227	225	223	221								12
14	193	191	189	187	185							14
16	167	165	163	161	159	157	157					16
18	147	145	143	141	139	137	137	129	122			18
20	131	129	127	125	123	120	121	113	107	102	97	20
22	117	115	113	111	109	107	106	100	95	91	86	22
24	106	103	102	100	97	95	94	88	84	80	76	24
26	96	94	92	90	87	85	84	78	75	72	67	26
28	87	85	83	81	78	76	75	69	67	64	60	28
30	80	78	76	74	71	68	67	62	60	57	54	30
32	74	72	70	68	64	61	61	55	53	50	47,5	32
34		66	64	62	58	56	55	49,5	47	44,5	41,5	34
36		61	59	57	53	50	49,5	44	42	39	36	36
38		57	55	52	48,5	45,5	45	39,5	37	34,5	31,5	38
40			51	48	44,5	41,5	40,5	35,5	33	30	27,1	40
44			44,5	41	37	34	33,5	28,1	25,3	22,6	19,4	44
48				35,5	31,5	28,3	27,4	22	19	16,1	12,3	48
52					26,6	23,3	22,2	16,8	13,5	9,8	5,7	52
56					22,6	19	17,7	12,1	7,7	5		56
60						15,4	13,8	7,3				60
64							10,2					64
68							6,9					68
m/s*	14		13			11			9			m/s*

* Zulässige Windgeschwindigkeit.
Permissible wind speed.
Vitesse du vent admissible.

TAB 50036

**Die Hubhöhen am SD-Auslegersystem.
Lifting heights at SD boom/derrick combination.
Hauteurs de levage en configuration SD.**

LR1550

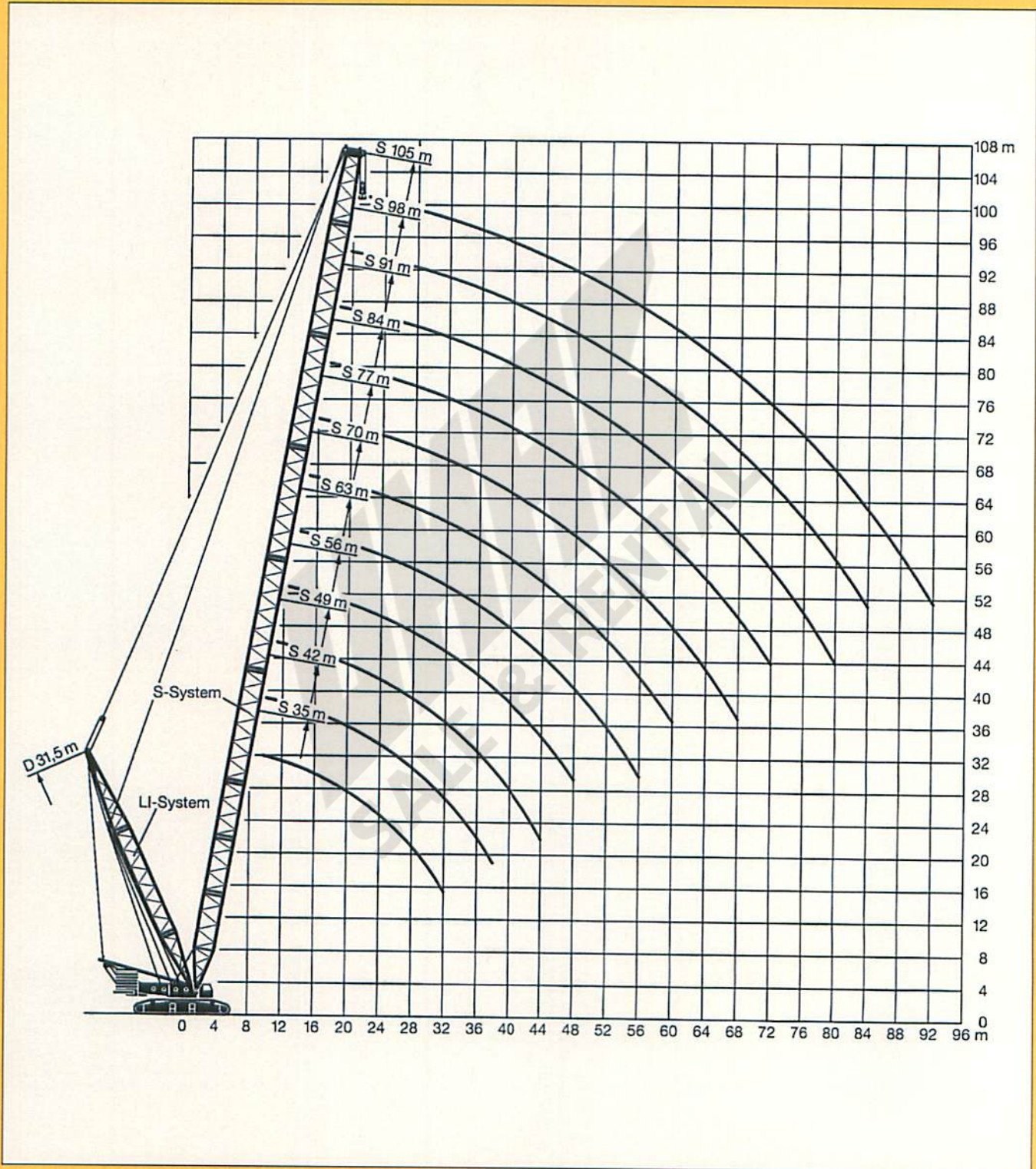

Die Traglasten am SDB-Auslegersystem. Lifting capacities at SDB boom/derrick combination. Forces de levage en configuration SDB.

LR1550



m	35 m	42 m	49 m	56 m	63 m	70 m	77 m	84 m	91 m	98 m	105 m	m
9	450											9
10	425	400										10
11	400	380										11
12	380	363	340	322								12
14	350	335	308	296	276							14
16	324	310	286	274	255	245	210					16
18	296	289	266	255	237	227	206	190	165			18
20	260	259	248	237	220	211	202	186	162	140	120	20
22	232	231	230	222	206	197	188	182	159	137	117	22
24	209	208	207	206	193	184	176	170	156	134	115	24
26	189	188	187	186	182	173	165	159	153	132	112	26
28	173	172	171	170	169	163	155	149	146	129	110	28
30	159	158	157	156	155	153	146	140	137	126	107	30
32	146	145	144	143	142	141	138	132	129	123	105	32
34		134	133	132	131	130	129	125	121	118	102	34
36		124	123	122	121	120	119	118	115	112	100	36
38		116	115	114	113	112	110	109	108	105	97	38
40			112	111	110	109	108	106	103	100	94	40
44			99	97	96	95	94	92	90	88	86	44
48				85	87	84	82	80	78	76	74	48
52					77	75	72	70	68	66	64	52
56					69	66	64	62	59	57	55	56
60						59	56	54	52	50	48	60
64							50	48	45	43	41	64
68								45	43	40	38	68
72									38	35	33	72
76										31	28	76
80										27	25	80
84											21	84
88												88
92												92
m/s*	14		13			11			9			m/s*

250 t Schwebelast mit 13 m Ausladung.
Suspended counterweight of 250 t with 13 m radius.
250 t lest suspendu avec 13 m de portée.

TAB 50049

* Zulässige Windgeschwindigkeit.
Permissible wind speed.
Vitesse du vent admissible.

**Die Hubhöhen am SDB-Auslegersystem.
Lifting heights at SDB boom/derrick combination.
Hauteurs de levage en configuration SDB.**

LR 1550

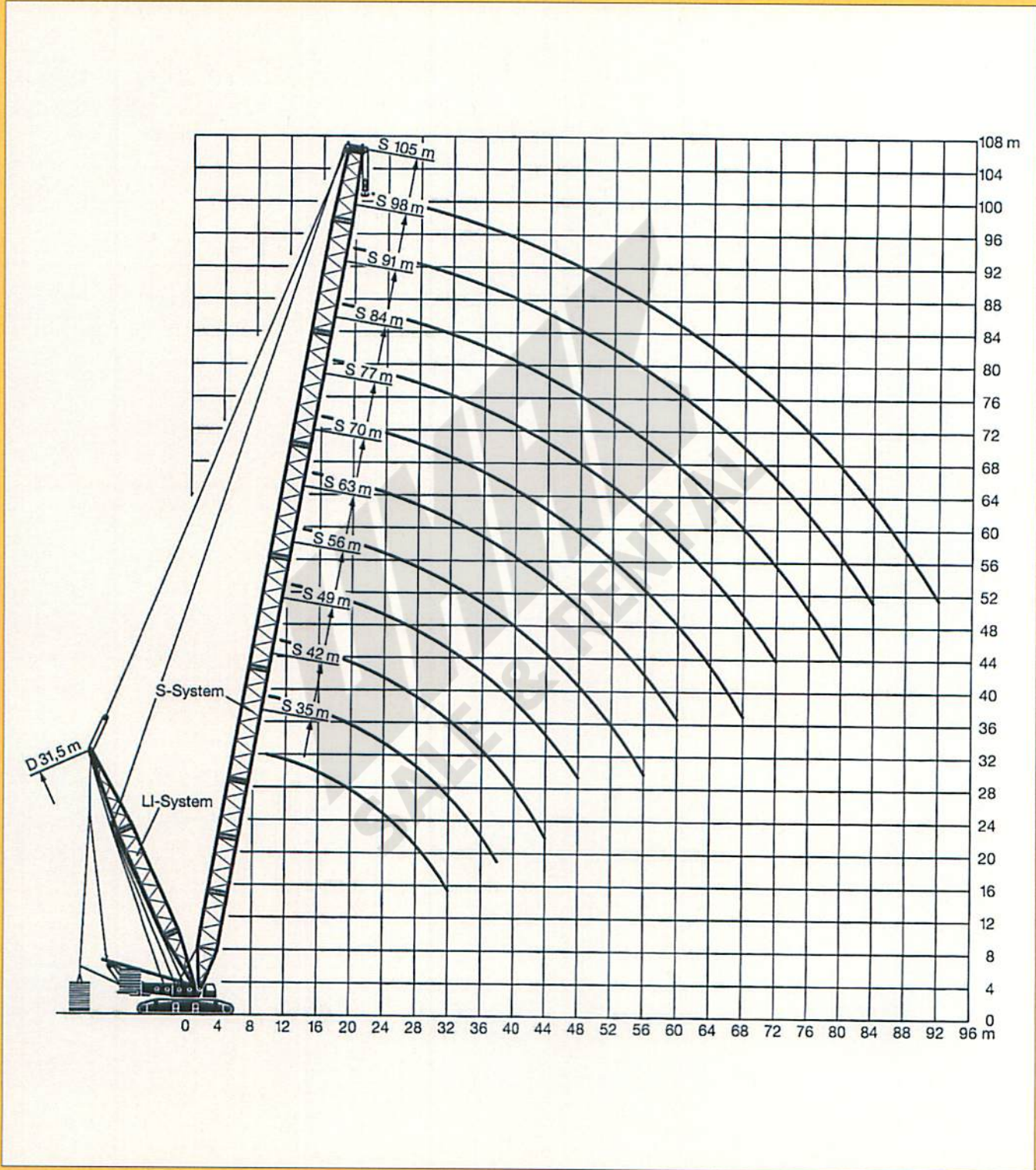

Die Traglasten am SDW-Auslegersystem.

LR 1550

Lifting capacities at SDW boom/derrick/jib combination.

Forces de levage en configuration SDW.



m	35 m								42 m								m		
	28 m	35 m	42 m	49 m	56 m	63 m	70 m	77 m	84 m	28 m	35 m	42 m	49 m	56 m	63 m	70 m		77 m	84 m
14	199									197									14
16	173	173								172	171								16
18	153	153	152							152	152	151							18
20	137	137	136	135	134					136	136	135	133	128					20
22	124	123	123	122	121	103				122	122	122	121	117	98				22
24	113	112	111	111	110	101	88			111	111	110	110	107	96	83			24
26	103	103	102	102	101	99	86	74		102	102	101	101	99	94	82	70		26
28	95	94	94	93	92	92	85	73	62	94	94	93	93	91	88	80	69	59	28
30	88	87	86	86	85	84	82	72	61	86	86	86	85	84	82	79	68	58	30
32		81	80	79	79	77	76	70	60		80	79	79	77	76	74	67	57	32
34		75	74	74	73	72	70	68	59		74	74	73	71	70	68	66	56	34
36		70	69	69	68	66	65	63	58		69	69	68	66	65	63	61	55	36
38			65	64	63	62	60	58	57		65	64	63	62	60	59	57	55	38
40			61	60	59	58	56	54	52			60	59	58	56	55	53	51	40
44			54	53	52	51	49	47	45,5			53	52	51	49	47,5	45,5	44	44
48				47,5	46	44,5	43	41	39,5				46,5	44,5	43	41,5	40	38	48
52					41	39,5	38	36	34,5					40	38	36,5	35	33	52
56					36,5	35	33,5	32	30					35,5	34	32,5	30,5	28,8	56
60						31,5	30	28,2	26,4						30,5	28,8	26,9	25,1	60
64						28,5	26,8	24,9	23,1						27,4	25,7	23,8	21,9	64
68							24	22,1	20,2							23	21	19,1	68
72								19,6	17,7								18,5	16,5	72
76								17,4	15,4								16,4	14,3	76
80									13,4									12,2	80
84									11,6									10,4	84

TAB 50102.1

m	49 m								56 m								m		
	28 m	35 m	42 m	49 m	56 m	63 m	70 m	77 m	84 m	28 m	35 m	42 m	49 m	56 m	63 m	70 m		77 m	84 m
16	171									170									16
18	151	151	146							150	146	140							18
20	135	135	132	128						135	132	127	122						20
22	122	122	120	116	113					122	120	116	112	102					22
24	111	111	110	107	103	91				111	110	106	103	99	85				24
26	102	101	100	98	95	89	78			101	101	98	95	92	83	73			26
28	94	93	92	91	88	85	77	65		93	93	91	88	85	82	72	63		28
30	86	86	85	84	82	79	75	64	55	86	85	84	82	79	76	71	62	53	30
32		80	79	77	76	74	71	63	54	80	79	77	75	74	71	68	61	52	32
34		74	73	72	70	68	67	62	53		73	71	70	68	66	64	60	51	34
36		69	68	67	65	63	62	60	53		68	67	65	63	61	60	57	51	36
38		65	63	62	60	59	57	55	52		64	62	60	59	57	55	53	50	38
40			59	58	56	55	53	51	49,5			58	56	55	53	51	49,5	47,5	40
44			53	51	49,5	48	46,5	44,5	42,5			51	49,5	48	46	44,5	42,5	41	44
48				45,5	43,5	42	40,5	39	37				44	42,5	40,5	39	37	35	48
52					39	37	35,5	34	32				39,5	37,5	35,5	34	32,5	30,5	52
56					35	33	31,5	29,7	27,9					33,5	31,5	30	28,2	26,4	56
60						29,5	28	26,1	24,3						28,2	26,5	24,7	22,8	60
64						26,5	24,8	22,9	21,1						25,2	23,5	21,6	19,6	64
68							22,2	20,2	18,3							20,9	18,9	16,8	68
72								17,8	15,7								16,5	14,3	72
76								15,6	13,4								14,3	12	76
80									11,4									9,8	80
84									9,5									7,7	84

TAB 50102.2



m	63 m								70 m								m
	35 m	42 m	49 m	56 m	63 m	70 m	77 m	84 m	35 m	42 m	49 m	56 m	63 m	70 m	77 m	84 m	
18	140								128								18
20	127	122							121	110							20
22	116	111	107						111	107	96						22
24	106	102	99	94					102	98	94	82					24
26	98	95	91	88	75				95	91	87	81	68				26
28	91	88	84	82	74	65			88	84	81	78	67	58			28
30	84	82	79	76	72	64	56		82	78	76	73	66	57	50		30
32	77	75	73	71	68	63	55	46	76	73	71	68	65	56	49,5	42	32
34	72	70	68	67	64	62	55	45,5	70	68	66	63	61	56	49	41,5	34
36	67	65	63	62	60	58	54	45	65	63	62	59	58	55	48	41	36
38	63	61	59	57	56	54	51	44,5	61	59	57	55	54	51	47,5	40,5	38
40		57	55	54	52	50	47,5	44		55	53	52	50	48	46	40	40
44		50	48,5	47	45	43,5	41	39		48,5	47	45	43,5	41,5	39,5	37	44
48			43	41,5	39,5	38	35,5	33,5			41,5	39,5	38	36	34	31,5	48
52			38,5	36,5	34,5	33	31	28,9			37	35	33,5	31,5	29,5	27	52
56				32,5	30,5	29,1	26,8	24,9				31	29,5	27,5	25,6	23	56
60					27,2	25,6	23,3	21,3					26,1	24,1	22,1	19,5	60
64					24,3	22,7	20,2	18,2					23,3	21,1	19,1	16,3	64
68						20,1	17,5	15,3						18,6	16,4	13,4	68
72						17,8	15,1	12,8						16,4	14	10,6	72
76							13	10,3							11,8	7,3	76
80								7,7								6,2	80
84								6,5								5,3	84

TAB 50102.3

m	77 m								m
	35 m	42 m	49 m	56 m	63 m	70 m	77 m	84 m	
20	110								20
22	106	95							22
24	98	93	82						24
26	91	87	81	70					26
28	84	81	78	69	60				28
30	79	75	73	68	59	50			30
32	74	71	68	65	58	49,5	43		32
34	68	66	64	61	58	49	42,5	37	34
36	64	62	60	57	55	48,5	42	36,5	36
38	60	57	56	54	51	47,5	41,5	36,5	38
40	56	54	52	50	48	46,5	41	36	40
44		47,5	45,5	43,5	41,5	40	37,5	35	44
48			40	38,5	36,5	35	32	30	48
52			36	34	32	30	27,8	25,8	52
56				30	28	26,4	23,9	21,8	56
60				26,9	24,7	23,1	20,4	18,3	60
64					21,9	20,1	17,4	15,1	64
68						17,6	14,7	12,1	68
72						15,4	12,2	8,7	72
76							9,8	6,4	76
80								5,4	80
84								4,5	84

TAB 50102.3

**Die Hubhöhen am SDW-Auslegersystem.
Lifting heights at SDW boom/derrick/jib combination.
Hauteurs de levage en configuration SDW.**

LR1550

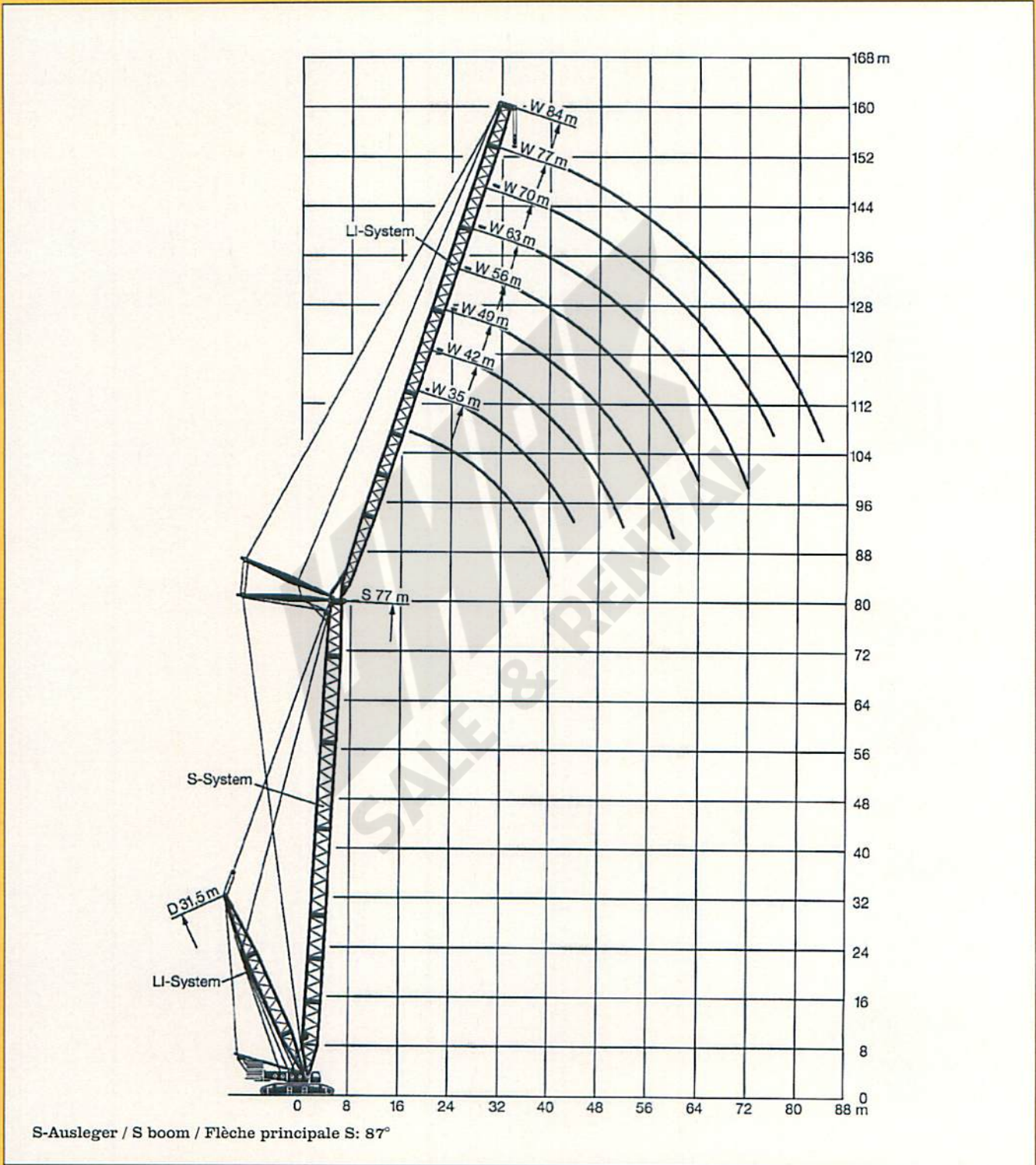

S-Ausleger / S boom / Flèche principale S: 87°

Die Traglasten am SDWB-Auslegersystem. Lifting capacities at SDWB boom/derrick/jib combination. Forces de levage en configuration SDWB.

LR 1550

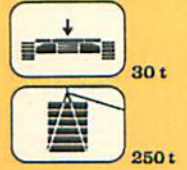

m	35 m								42 m								m		
	28 m	35 m	42 m	49 m	56 m	63 m	70 m	77 m	84 m	28 m	35 m	42 m	49 m	56 m	63 m	70 m		77 m	84 m
14	290									260									14
16	280	240								249	220								16
18	270	233	195							238	213	182							18
20	255	225	190	163	138					227	207	177	153	129					20
22	240	218	184	159	134	103				217	200	173	149	126	98				22
24	225	210	179	154	131	101	88			206	194	168	145	123	96	83			24
26	205	203	173	150	127	99	86	74		195	187	164	141	119	94	82	70		26
28	188	188	168	145	123	97	85	73	62	184	181	159	137	116	92	80	69	59	28
30	162	174	163	141	120	95	83	72	61	169	173	154	133	113	90	79	68	58	30
32		161	157	136	116	93	81	70	60		161	150	129	110	88	77	67	57	32
34		150	149	132	112	90	80	69	59		150	145	126	106	86	76	66	56	34
36		133	139	127	109	88	78	68	58		138	139	122	103	84	74	64	55	36
38			130	123	105	86	76	67	57		120	130	118	100	82	73	63	55	38
40			118	118	101	84	75	65	56			121	114	97	80	71	62	54	40
44			93	107	94	80	71	63	54			96	106	90	77	68	60	52	44
48				90	87	76	68	60	52				92	84	73	65	58	50	48
52					79	72	64	58	50					77	69	62	55	48	52
56					69	67	61	55	49					71	65	59	53	47	56
60						63	58	53	47						61	56	51	45	60
64						54	54	50	45						56	53	49	43	64
68							51	48	43							50	46	41	68
72								45	41								44	39	72
76								41	39								42	38	76
80									37									36	80
84									32									33	84

TAB 50080.1

m	49 m								56 m								m		
	28 m	35 m	42 m	49 m	56 m	63 m	70 m	77 m	84 m	28 m	35 m	42 m	49 m	56 m	63 m	70 m		77 m	84 m
16	215									180									16
18	208	190	168							176	158	140							18
20	201	185	164	143						171	155	137	122						20
22	194	180	160	140	117					167	151	135	120	102					22
24	186	175	156	136	114	91				163	148	132	118	100	85				24
26	179	170	153	133	111	89	78			158	144	129	115	98	83	73			26
28	172	165	149	130	109	87	77	65		154	141	127	113	96	82	72	63		28
30	165	160	145	127	106	86	75	64	55	149	137	124	111	94	80	71	62	53	30
32		155	141	123	103	84	74	63	54	145	134	121	109	92	79	69	61	52	32
34		150	137	120	100	82	72	62	53		130	118	107	90	77	68	60	51	34
36		139	133	116	98	80	71	61	53		127	116	105	88	76	67	59	51	36
38		121	130	113	95	78	69	60	52		123	113	102	86	74	66	58	50	38
40			122	109	92	77	68	59	51			110	100	84	73	64	57	49	40
44			97	102	87	73	65	57	49			99	96	80	70	62	55	48	44
48				92	81	69	62	55	48				91	76	66	59	53	46	48
52					76	66	59	53	46				75	72	63	57	52	44	52
56					70	62	57	51	44					68	60	54	50	43	56
60						59	54	49	43						57	52	48	41	60
64							55	51	47	41					54	49	46	40	64
68								48	45	40						47	44	38	68
72									43	38							42	37	72
76									41	36							40	35	76
80										35								34	80
84										32								32	84

TAB 50080.2

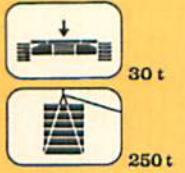

m	63 m								70 m								m
	35 m	42 m	49 m	56 m	63 m	70 m	77 m	84 m	35 m	42 m	49 m	56 m	63 m	70 m	77 m	84 m	
18	145								128								18
20	141	125							125	110							20
22	137	122	110						121	108	96						22
24	133	119	108	94					118	105	94	82					24
26	129	116	106	92	75				115	103	93	81	68				26
28	125	113	104	90	74	65			112	100	91	79	67	58			28
30	121	110	101	89	72	64	56		108	98	89	78	66	57	50		30
32	117	108	99	87	71	63	55	46	105	96	88	77	65	56	49	42	32
34	113	105	97	85	70	62	55	46	102	93	86	75	64	56	49	42	34
36	109	102	95	83	69	61	54	45	98	91	84	74	63	55	48	41	36
38	105	99	93	81	67	60	53	45	95	88	83	72	62	54	48	41	38
40		96	91	80	66	59	53	44		86	81	71	61	53	47	40	40
44		90	87	76	64	57	51	43		81	78	68	59	52	46	39	44
48			82	72	61	55	50	42			74	66	56	50	45	38	48
52			78	69	59	54	48	41			71	63	54	49	43	37	52
56				65	56	52	47	40				60	52	47	42	36	56
60					54	50	46	39					50	46	41	36	60
64					51	48	44	38					48	44	40	35	64
68						46	43	37						43	38	34	68
72						44	41	36						41	37	33	72
76							40	35							36	32	76
80								33								31	80
84								32								30	84

TAB 50080.3

m	77 m								m
	35 m	42 m	49 m	56 m	63 m	70 m	77 m	84 m	
20	110								20
22	108	95							22
24	105	93	82						24
26	103	91	81	70					26
28	100	89	79	69	60				28
30	98	87	78	68	59	50			30
32	95	85	77	67	58	49	43		32
34	93	82	76	66	58	49	43	37	34
36	90	80	74	66	57	48	42	37	36
38	88	78	73	65	56	48	42	36	38
40	85	76	72	64	55	47	41	36	40
44		72	69	62	53	46	40	35	44
48			67	60	52	45	39	34	48
52			64	59	50	44	38	34	52
56				57	48	43	37	33	56
60				55	47	41	36	32	60
64					45	40	35	32	64
68						39	34	31	68
72						38	33	30	72
76							32	29	76
80								29	80
84								28	84

TAB 50080.3

Die Hubhöhen am SDWB-Auslegersystem.
Lifting heights at SDWB boom/derrick/jib combination.
Hauteurs de levage en configuration SDWB.

LR1550

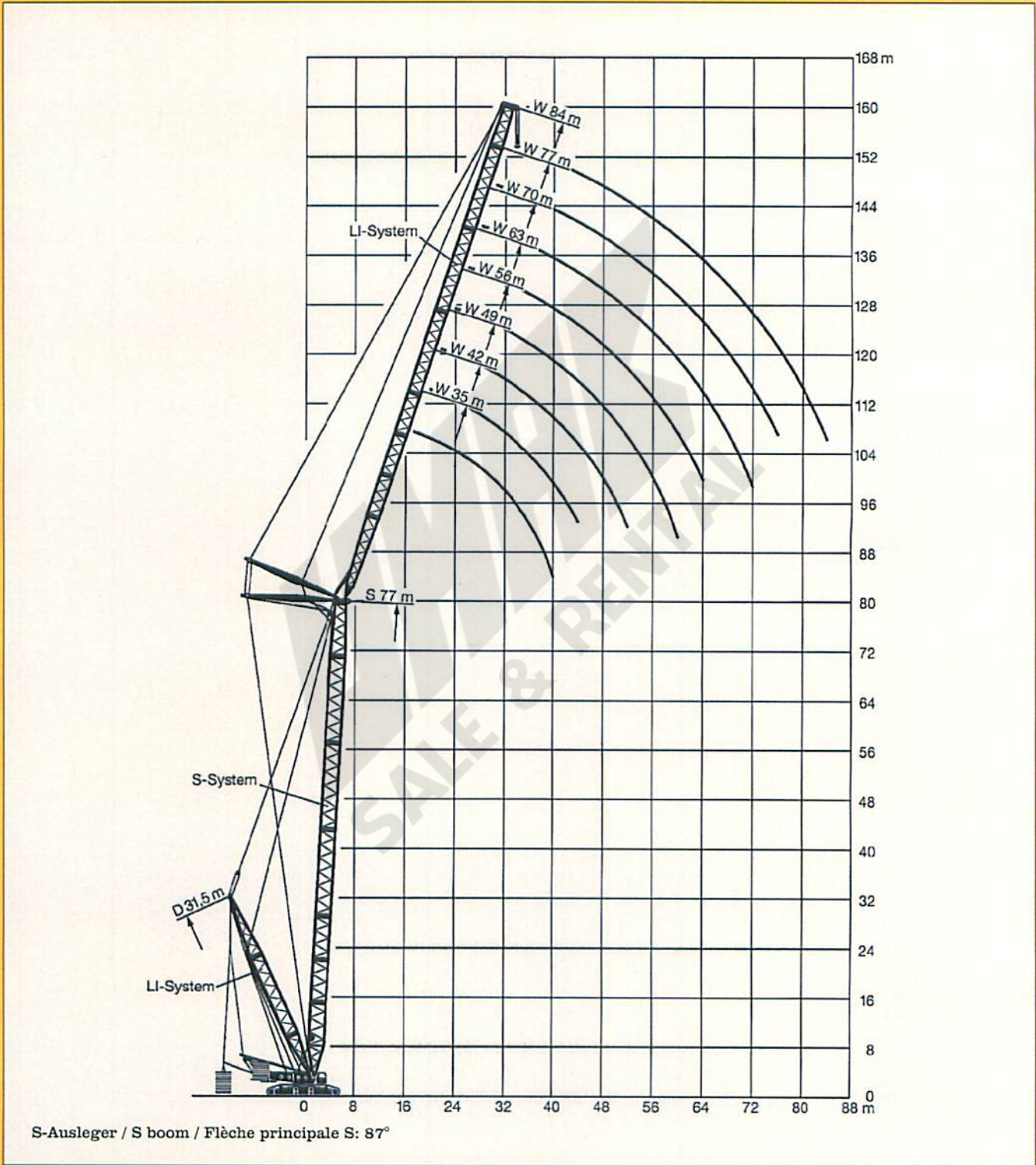

Die Traglasten am SDWB-Auslegersystem. Lifting capacities at SDWB boom/derrick/jib combination. Forces de levage en configuration SDWB.

LR 1550



m	35 m									42 m									m
	28 m	35 m	42 m	49 m	56 m	63 m	70 m	77 m	84 m	28 m	35 m	42 m	49 m	56 m	63 m	70 m	77 m	84 m	
34	147																		34
36	138																		36
38	129	128								124									38
40	121	121								117									40
44	108	108	106							104	103								44
48		97	95	94							93	91							48
52			86	85	83						84	82	81						52
56			78	77	75	74						75	74	72					56
60				71	69	67	66					69	68	66	64	62			60
64				65	63	61	60	59					62	60	58	57	56		64
68					58	56	55	54	48					55	54	52	51	47	68
72					54	52	51	49	47					51	49	48	46	44	72
76						48	47	45	43						46	44	43	41	76
80							43	42	40							42	41	39	80
84							40	39	37								38	36	84
88								36	34								35	33	88
92									33	31								31	92
96										29									96
100										27									100

TAB 50081.1

m	49 m									56 m									m
	28 m	35 m	42 m	49 m	56 m	63 m	70 m	77 m	84 m	28 m	35 m	42 m	49 m	56 m	63 m	70 m	77 m	84 m	
40	114																		40
44	102	101								97									44
48	91	90	88							87	86								48
52		82	80	78						79	78	76							52
56		74	72	71	69						71	69	67						56
60			66	65	63	61						63	61	60					60
64				60	58	56	54					58	56	54	52				64
68				55	53	51	50	48					52	50	48	46			68
72					49	47	46	44	42				48	46	44	42	41		72
76					45	43	42	40	38					42	40	39	37	35	76
80						40	39	37	35					39	37	36	34	32	80
84						37	36	34	32						34	33	31	29	84
88							33	31	29							30	29	26	88
92								29	27							28	26	24	92
96									27	24							24	22	96
100										22								22	100
104										21									104
108																		18	108

TAB 50081.2



67°
63 m -
77 m



31,5 m



35 m -
84 m



8,8 m x
8,5 m



360°



160 t



30 t



250 t

m	63 m								70 m								m
	35 m	42 m	49 m	56 m	63 m	70 m	77 m	84 m	35 m	42 m	49 m	56 m	63 m	70 m	77 m	84 m	
52	75								64	62							52
56	68	66							59	57	55						56
60	62	60	59						54	52	50	48					60
64		55	54	52						47	46	44	42				64
68		51	49	47	45					42	40	38	36				68
72			45	43	42	40				39	37	35	33	31			72
76			42	40	38	36	35				34	32	30	28	26		76
80				37	35	33	32	29			31	29	27	26	23		80
84					32	31	29	27			27	25	23	21	19		84
88					30	28	26	24			25	23	21	19	17		88
92						26	24	22			21	19	17	15	13		92
96						24	22	20			19	17	15	13	11		96
100							20	18			17	15	13	11	9		100
104							18	16			16	14	12	10	8		104
108								15			15	13	11	9	7		108
112											14	12	10	8	6		112
116											13	11	9	7	5		116

TAB 50081.3



m	77 m								m
	35 m	42 m	49 m	56 m	63 m	70 m	77 m	84 m	
56	60								56
60	55	53							60
64	50	48	47						64
68		44	43	41					68
72		40	39	37	36				72
76			36	34	32	31			76
80			33	31	30	28	26		80
84				29	27	25	24	21	84
88				26	25	23	21	19	88
92					23	21	19	17	92
96						19	17	15	96
100						17	16	14	100
104							14	12	104
108							13	11	108
112								9	112
116								8	116

TAB 50081.3

Die Hubhöhen am SDWB-Auslegersystem. Lifting heights at SDWB boom/derrick/jib combination. Hauteurs de levage en configuration SDWB.

LR1550

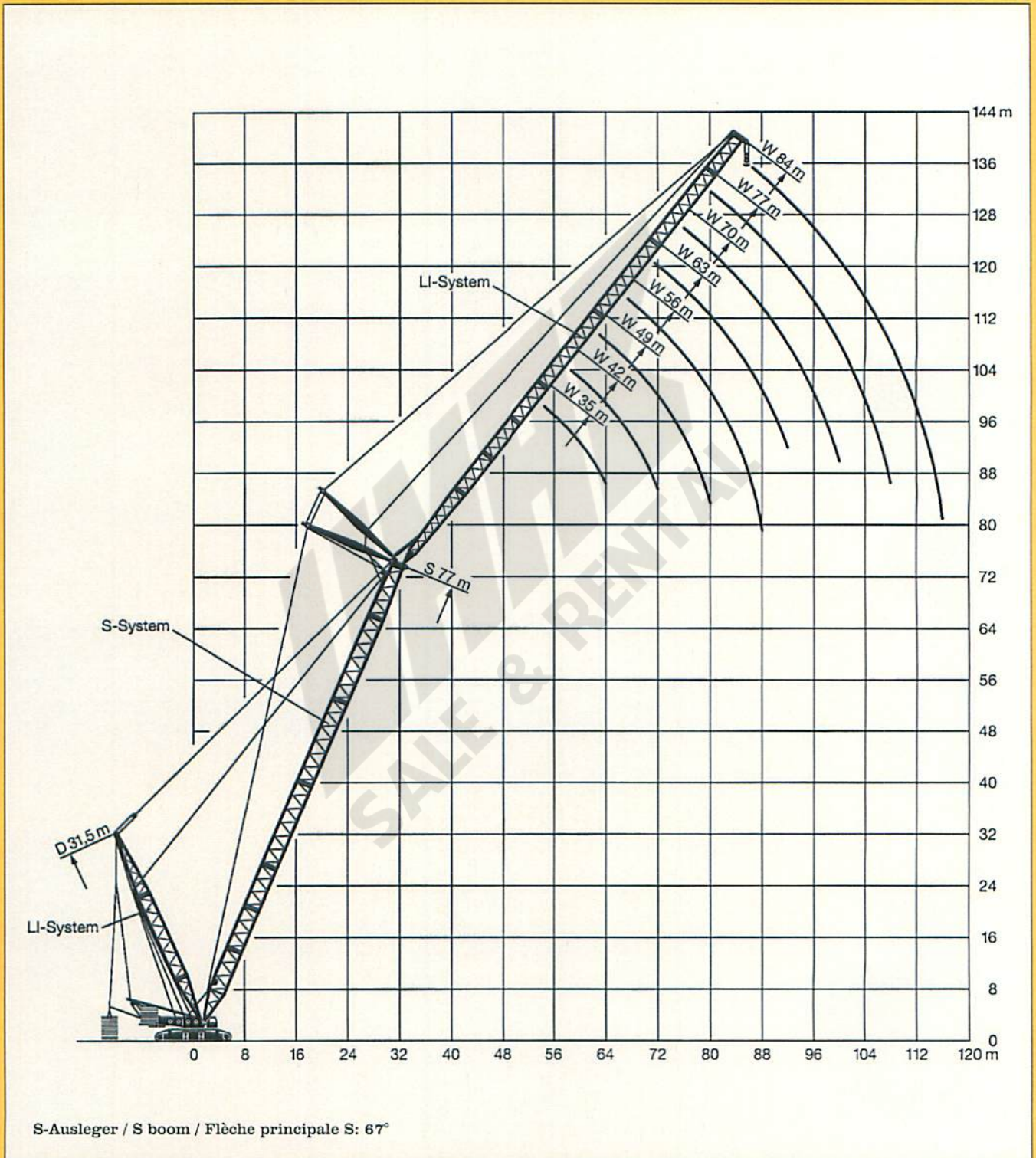

Änderungen vorbehalten. / Subject to modification. / Sous réserve de modifications.

TP 178 d. 9.97

Nehmen Sie Kontakt auf mit
Please contact
Veuillez prendre contact avec
LIEBHERR-WERK EHINGEN GMBH
D-89582 Ehingen/Donau, Telefon (0 73 91) 5 02-0, Telefax (0 73 91) 5 02-3 99