

The synergy of wide experience, research and development for your success and benefit.

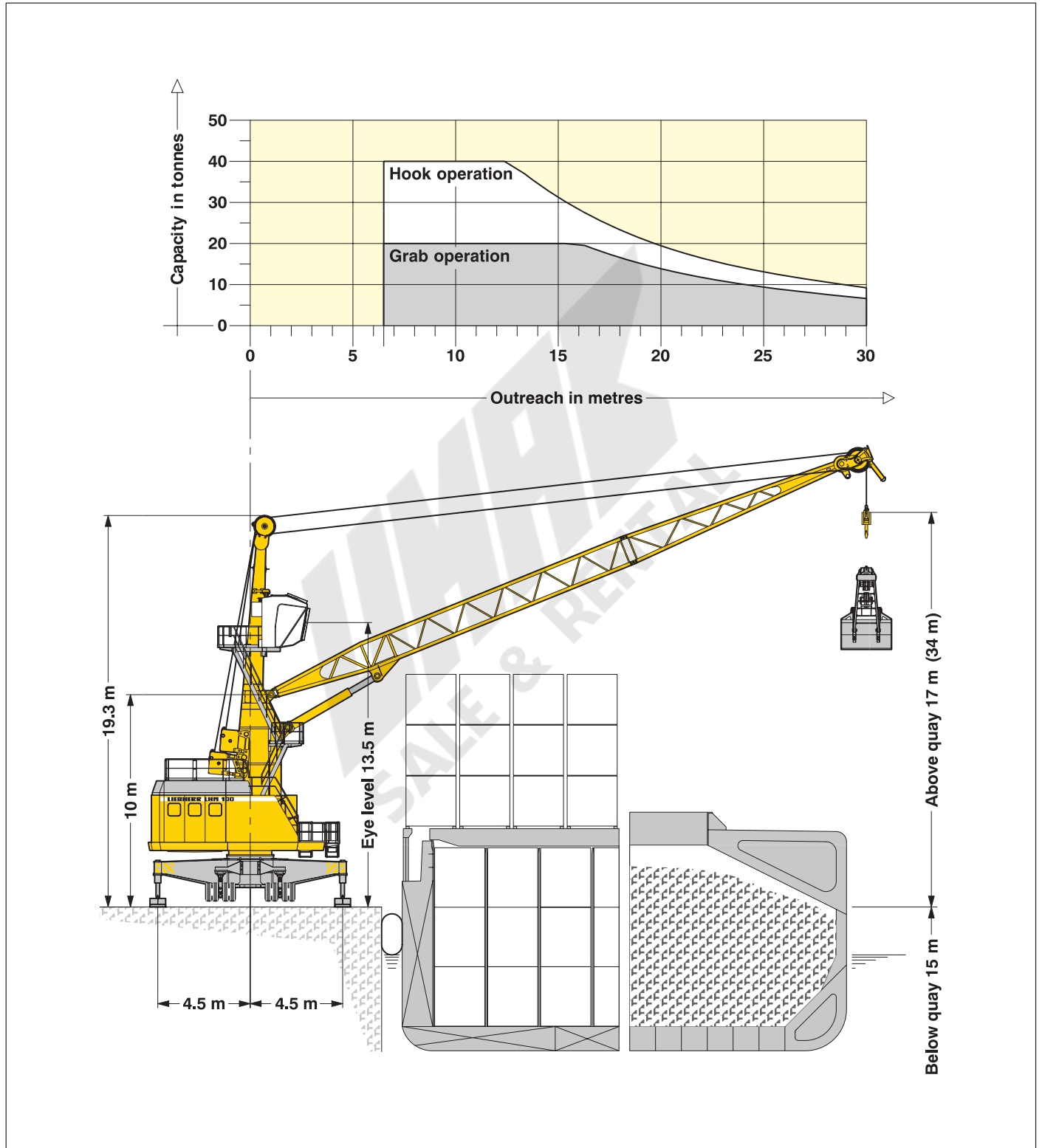

8900 925 14 -05/2007 Subject to change without notice.

Liebherr harbour mobile crane

Type LHM 100 Litronic®

- utmost performance
- high reliability and quality
- low operational costs
- unsurpassed mobility and versatility
- worldwide service network

Radius	Hook operation	Grab operation
(m)	(t)	(t)
6.5	40.0	20.0
8	40.0	20.0
10	40.0	20.0
12	40.0	20.0
15	30.3	20.0
16	27.5	19.5
17	25.0	17.8
18	22.7	16.2
19	20.8	14.8
20	19.1	13.6
21	17.7	12.6
22	16.3	11.6
23	15.1	10.7
24	14.1	10.0
25	13.1	9.3
26	12.2	8.6
27	11.4	8.1
28	10.6	7.5
29	9.9	7.0
30	9.2	6.6

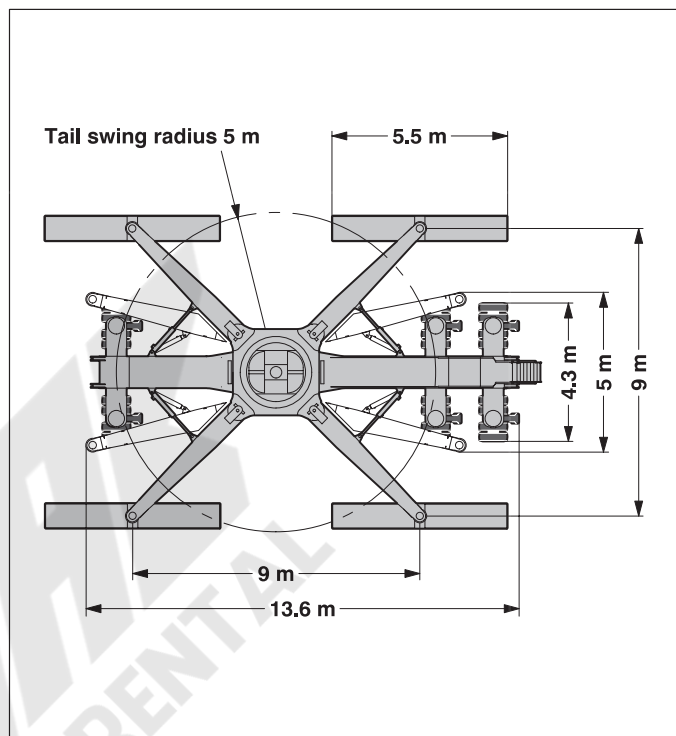

Capacities

Standard operation _____ 40 t

Main dimensions

Min to max. outreach _____ 6.5 – 30 m
 Height of boom fulcrum _____ 10.0 m
 Tower cabin height (eye level) _____ 13.5 m

Hoisting heights

Above quay at minimum radius _____ 34 m
 Above quay at maximum radius _____ 17 m
 Below quay _____ 15 m

Working speeds

Hoisting / lowering _____ 0 – 70 m/min
 Slewing _____ 0 – 1.5 rpm
 Luffing _____ 0 – 45 m/min
 Travelling _____ 0 – 90 m/min

Quay load arrangements

Uniformly Distributed Load _____ 1.1 t/m²
 Max. load per tyre _____ 5.3 t

Due to its unique travelling and supporting system, the parameters of the undercarriage (pad sizes, supporting base and number of axle sets) can easily be adapted to comply with the most stringent quay load restrictions.

Weights

Weight of the crane _____ 101 t
 Counterweight _____ 15 t
 Total weight of the crane _____ approx. 116 t

Propping arrangements

Standard supporting base _____ 9 m x 9 m
 Standard pad dimension _____ 4x 5.5 m x 0.8 m