

Tower Crane
Grue à tour / Gru a torre
Guindaste de torre / Grúa torre

Turmdrehkran 80 LC

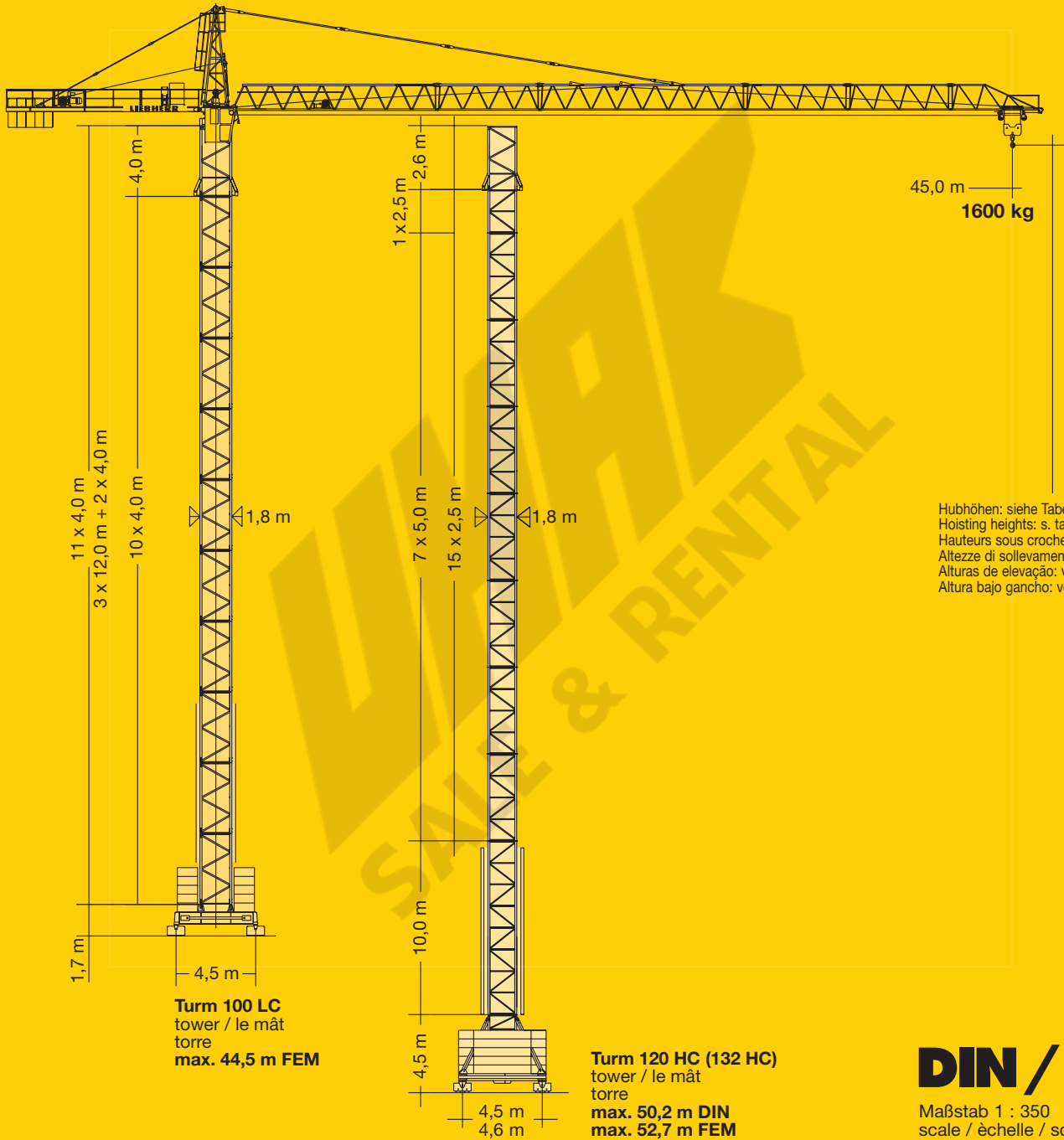

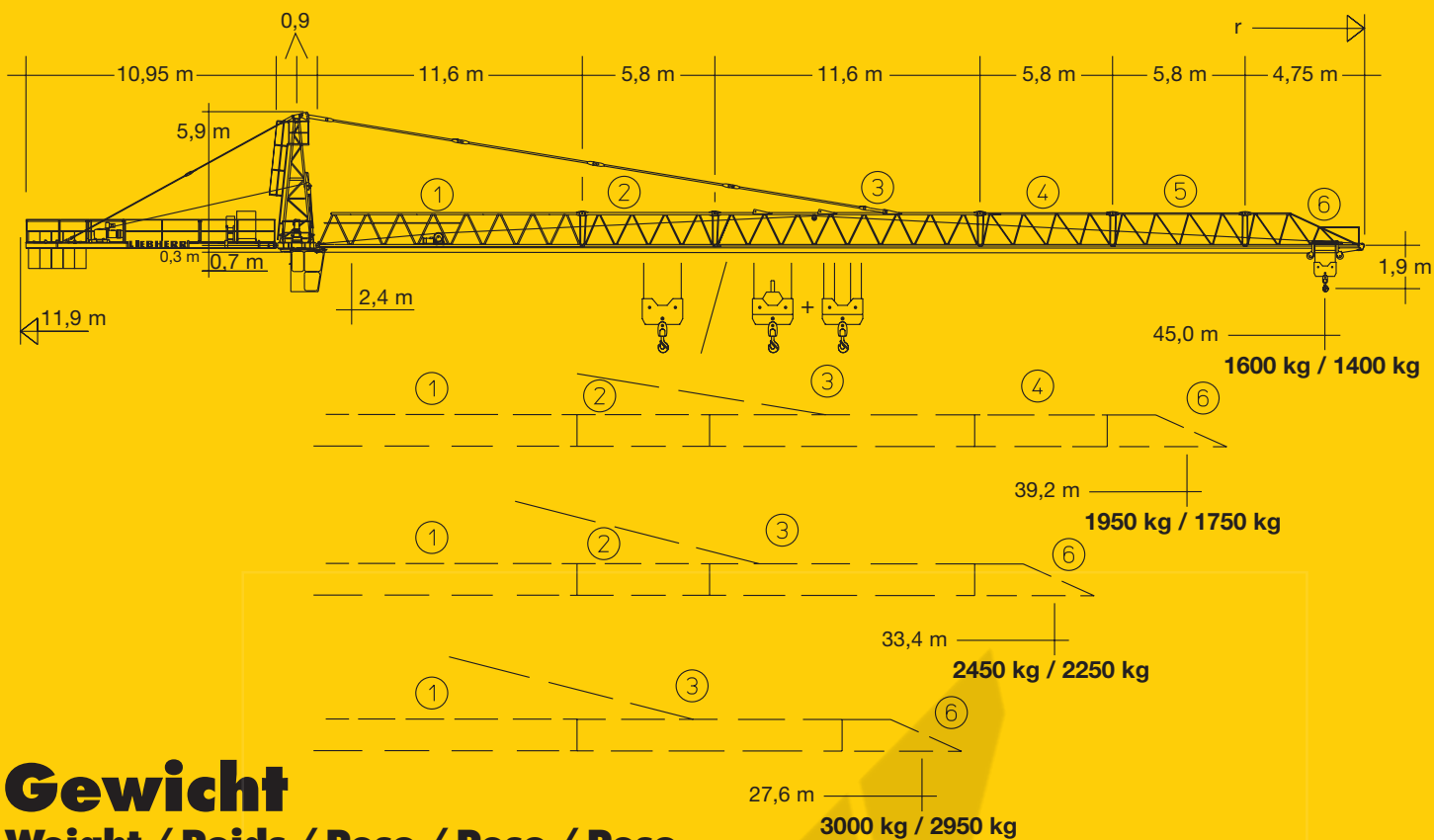

Gewicht

Weight / Poids / Peso / Peso / Peso

Zentralballast / Central ballast Lest de base / Zavorra centrale Lastro central / Lastre central	75.000 kg	Gegengewicht / Counter weight Contre-poids / Contrappeso Contra peso / Contrapeso	(Ausl. 50 m) 10.000 kg
Konstruktionsgewicht ca. / Dead weight approx. Poids de la construction env. / Peso della costruzione circa Peso da construção aprox. / Peso de construcción aprox.			35.400 kg

Hubhöhe

Hoisting height / Hauteur sous crochet

Altezza di sollevamento / Altura de elevação / Altura bajo gancho

mit Turm / with tower avec mât / con torre com torre / con torre		100 LC			
zuzüglich Turmstücke plus tower sections plus éléments de mât Elementi di torre aggiuntivi Peças suplemen- -tares de torre más tramos de torre		①	⑤	⑥	③
4 m	12 m				
1		4,5	4,4	4,1	3,1
2		8,5	8,4	8,1	7,1
3	1	12,5	12,4	12,1	11,1
4		16,5	16,4	16,1	15,1
5		20,5	20,4	20,1	19,1
6	2	24,5	24,4	24,1	23,1
7		28,5	28,4	28,1	27,1
8		32,5	32,4	32,1	31,1
9	3	36,5	36,4	36,1	35,1
10		40,5*	40,4*	40,1*	39,1*
FEM 11		44,5*	44,4*	44,1*	43,1*

* Führungsstück nach Montage ablassen. / Lower guide section after erection. / Baissez la cage télescopique après le montage. / Abbassare la gabbia di sopraelevazione dopo il montaggio. / Abaixar a peça de guia ao cabo do montagem. / Bajar tramo telescópico después del montaje. Weitere Hubhöhen auf Anfrage. / Further hoist heights on request. / Hauteurs sous crochet sur demande. / Altre altezze di sollevamento: su richiesta. / Outras alturas de elevação: conforme ao pedido. / Para alturas bajo gancho superiores, consultar.

mit Turm / with tower avec mât / con torre com torre / con torre		120 HC (132 HC)					
zuzüglich Turmstücke plus tower sections plus éléments de mât Elementi di torre aggiuntivi Peças suplemen- -tares de torre más tramos de torre							
0	15,2	14,7	10,9	12,4	12,2	12,2	
1	17,7	17,2	13,4	14,9	14,7	14,7	
2	20,2	19,7	15,9	17,4	17,2	17,2	
3	22,7	22,2	18,4	19,9	19,7	19,7	
4	25,2	24,7	20,9	22,4	22,2	22,2	
5	27,7	27,2	23,4	24,9	24,7	24,7	
6	30,2	29,7	25,9	27,4	27,2	27,2	
7	32,7	32,2	28,4	29,9	29,7	29,7	
8	35,2	34,7	30,9	32,4	32,2	32,2	
9	37,7	37,2	33,4	34,9	34,7	34,7	
10	40,2	39,7	35,9	37,4	37,2	37,2	
11	42,7	42,2	38,4	39,9	39,7	39,7	
12	45,2	44,7	40,9	42,4	42,2	42,2	
13	47,7	47,2	43,4	44,9	44,7	44,7	
DIN 14	50,2	49,7	45,9	47,4	47,2	47,2	
FEM 15	52,7*	52,2*	48,4*	49,9*	49,7*	49,7*	

* Führungsstück nach Montage ablassen. / Lower guide section after erection. / Baissez la cage télescopique après le montage. / Abbassare la gabbia di sopraelevazione dopo il montaggio. / Abaixar a peça de guia ao cabo do montagem. / Bajar tramo telescópico después del montaje. Weitere Hubhöhen auf Anfrage. / Further hoist heights on request. / Hauteurs sous crochet sur demande. / Altre altezze di sollevamento: su richiesta. / Outras alturas de elevação: conforme ao pedido. / Para alturas bajo gancho superiores, consultar.

Ausladung und Tragfähigkeit

Radius and capacity / Portée et charge / Sbraccio e portata

Alcance e capacidade de carga / Alcances y cargas



Auslegerlänge Length of jib Longueur de flèche Lunghezza braccio Comprimento da lança Longitud de pluma m	m/kg	max. kg																
		15,0	17,0	19,0	21,0	23,0	25,0	27,6	31,0	33,4	37,0	39,2	41,0	43,0	45,0			
45,0 (r=46,4)	2,4-26,4 3000							2860	2490	2290	2030	1890	1790	1690	1600			
39,2 (r=40,6)	2,4-27,1 3000							2940	2570	2360	2090	1950						
33,4 (r=34,8)	2,4-28,0 3000							3000	2670	2450								
27,6 (r=29,0)	2,4-27,6 3000							3000										
m	r	m/kg	+		15,0	17,0	19,0	21,0	23,0	25,0	27,6	31,0	33,4	37,0	39,2	41,0	43,0	45,0
45,0 (r=46,4)		2,4-24,9 3000	2,4-13,9 6000		5480	4740	4160	3690	3310	2990	2650	2290	2090	1820	1690	1590	1490	1400
39,2 (r=40,6)		2,4-25,6 3000	2,4-14,2 6000		5650	4880	4280	3800	3410	3090	2740	2370	2160	1890	1750			
33,4 (r=34,8)		2,4-26,5 3000	2,4-14,7 6000		5860	5070	4450	3960	3550	3210	2850	2470	2250					
27,6 (r=29,0)		2,4-27,2 3000	2,4-15,1 6000		6000	5230	4600	4090	3670	3320	2950							

















Geschwindigkeiten

Speeds / Vitesses / Velocità

Velocidades

















	0,8 min ⁻¹	5,0 kW
	9,0/30,0/60,0 m/min	0,65/2,0/3,0 kW
	18,0 m/min 23,0 m/min	4,4 kW 2 x 3,0 kW
Anschlußwert Kranoberteil Power requirement, upper part Puissance requise, partie supérieure Potenze assorbite, parte superiore della gru Potência ligada, parte superior do guindaste Potencia requerida, parte superior		Hubwerk / Hoist gear Mécanisme de levage / Argano Mecanismo elevatório Mecanismo de elevación 18,5 kW 30,0 kW
kVA		33,0 40,0

Hubwerk / Hoist gear / Mécanisme de levage / Argano / Mecanismo elevatório / Mecanismo de elevación	Stufe / Step Cran / Marcia Marcha	kg	m/min
18,5 / 18,5 / 3,7 kW Hubhöhe (2 Lagen) Hoisting height (2 layers) Hauteur sous crochet (2 couches) Altezza sollevamento (2 strati) Altura de elevação (2 camadas) Altura bajo gancho (2 capas)		1 3000	6,5
		2 3000	32,0
		3 1500	64,0
18,5 / 18,5 / 3,7 kW Hubhöhe (8 Lagen) Hoisting height (8 layers) Hauteur sous crochet (8 couches) Altezza sollevamento (8 strati) Altura de elevação (8 camadas) Altura bajo gancho (8 capas)		1 3000	5,3
		2 3000	27,0
		3 1300	53,0
18,5 / 18,5 / 3,7 kW Hubhöhe (8 Lagen) Hoisting height (8 layers) Hauteur sous crochet (8 couches) Altezza sollevamento (8 strati) Altura de elevação (8 camadas) Altura bajo gancho (8 capas)		1 6000	2,6
		2 6000	13,0
		3 2800	27,0
30,0 / 30,0 / 6,2 kW Hubhöhe (7 Lagen) Hoisting height (7 layers) Hauteur sous crochet (7 couches) Altezza sollevamento (7 strati) Altura de elevação (7 camadas) Altura bajo gancho (7 capas)		1 3000	9,5
		2 3000	45,0
		3 1350	90,0
30,0 / 30,0 / 6,2 kW Hubhöhe (7 Lagen) Hoisting height (7 layers) Hauteur sous crochet (7 couches) Altezza sollevamento (7 strati) Altura de elevação (7 camadas) Altura bajo gancho (7 capas)		1 6000	4,5
		2 6000	22,5
		3 2850	45,0

Kolli-Liste

Packing List / Liste de colisage / Lista dei colli
Lista de embalagem / Lista de dimensiones y pesos

Montagegewichte: siehe Betriebsanweisung.
Erection weights: see instruction manual.
Poids de montage: voir manuel de service.
Pesi di montaggio: vedasi le istruzioni sull'uso.
Pesos de montaje: vejam-se as instruções p. uso.
Peso para el montaje: según manual.

Kranoberteil		Upper part of crane / Partie supérieure de gru Parte superiore della gru / Parte superior grúa Parte superior do guindaste	L (m)	B (m)	H (m)	kg		
Pos. Item Rep Voce Ref Pos.	Anz. Qty. Qte. Qta. Quant. Cant.	Kabine + Steuerstand / Cabin + Seat Cabine + fauteuil / Cabina + poltrona Cabine + cadeira / Cabina + butaca			1,87	1,12	2,18	440
1	1							
2	1	Turmspitze / Tower head section Porte-flèche / Testa porta-braccio Cabeça de apoio de lança / Cabeza de torre			5,62	1,16	1,57	610
3	1	Gegenausleger / Counter-jib Contre-flèche / Contrabaccio Contra-lança / Contrapluma			11,03	1,67	0,43	1330
4	1	Ausleger-Anlenkstück / Jib heel section Pied de flèche / Settore articolato di braccio Base articulada de lança / Pluma tramo primero			11,79	1,17	1,59	① 1390
5	1	Ausleger-Zwischenstück / Intermediate jib section Elément interm. de flèche / Spezzone di braccio Peça suplementar da lança / Tramo intermedio pluma			6,03 11,83 6,02 6,00	1,17 1,17 1,17 1,17	1,54 1,63 1,53 1,51	② 483 ③ 877 ④ 323 ⑤ 267
6	1	Ausleger-Kopfstück / Jib head Pointe de flèche / Punta freccia Cabeça de lança / Tramo punta de pluma			5,29	1,17	1,51	⑥ 259
7	1	Podeste / Platforms Plates-formes / Plattaforma Plataforma / Plataforma			1,68	0,67	1,82	210
8	1	Laufkatze / Trolley Chariot / Carrello Carrinho / Carrito			1,57	1,34	0,81	190



Technische Daten

Technical data - Caractéristiques techniques
Caratteristiche tecniche - Características técnicas - Datos técnicos

Pos. Anz.
Item Qty.
Rep Qte.
Voce Qta.
Ref Quant.
Pos. Cant.

L (m) B (m) H (m) kg

Einzelgewichte. / Single weights. / Poids individuels.
Pesi di componenti.
Pesos de peças componentes.
Pesos unitarios.

9	1	Drehbühne mit Kud-Auflage / Slewing platform with slewing ring support / Ensembles mât cabine avec pivot cage / Plataforma girevole con supporto della ralla di rotazione / Plataforma giratória con suporte de corôa dentada / Asiento pista con plataforma giratoria		1,60	2,01	1,93	2590	
10	1	Hubwerk / Winch Treuil / Verricello / Mecanismo elevatorio / Mecanismo elevación carga		1,50	1,36	0,71	655	
Turm Tower / Mât / Torre								
Torre / Torre								
11	1	Turmstück / Tower section Element de mât / Elemento di torre Torre / Torre		12 m 4 m	12,27 4,27	1,80 1,80	1,80 1,90	2870 1105
Klettereinrichtung Climbing equipment / Equipement de télescopage / Attrezzatura per allungamento della gru								
Acessórios p. subida no edificio / Equipo de trepado								
12	1	Führungsstück kpl. / Guide section cpl. Cage télescopique cpl. / Gabbia de sopraelevazione compl. Peça de guia compl. / Torre de montaje completa		8,92	2,25	2,35	2180	
13	1	KUD-Auflagenverlängerung / Slewing ring support extension Rehausse de pivot d'orientation / Prolunga supporto ralla Peça de guia / Prolongación asiento de pista		4,27	2,26	2,26	1370	
14	1	Hydraulikanlage, Stütz- und Klettertraverse / Hydraulic unit, supporting and climbing cross members Système hydraulique avec traverses d'appui et de télescopage / Sistema idraulico, traversa di appoggio e allungamento gru Instalação hidráulica, travessa de apoio e subida / Sistema hidráulico con traviesa de apoyo y trepado						
Fundamentkreuz Cruciform base / Châssis en croix / Carro della gru								
Carro de guindaste / Base cruciforme								
15	1	Tragholm I / Arm I Longeron I / Longherone I Travessa I / Brazo I		6,66	0,71	0,75	2110	
16	2	Tragholm II / Arm II Longeron II / Longherone II Travessa II / Brazo II		6,66	0,78	0,75	2330	
17	2	Fahrschemel mit Antrieb / Rail bogie with drive Bogie moteur / Telaio con gruppo propulsore Quadro sem grupo de propulsão / Caja rodillo motriz		1,07	0,52	0,65	460	
18	2	Fahrschemel ohne Antrieb / Rail bogie without drive Bogie fou / Telaio senza gruppo propulsore Quadro com grupo de propulsão / Caja rodillo conducido		1,07	0,25	0,65	380	
19	1	Seile und Kleinteile / Small parts and ropes Accessoire et câbles / Accessori cavi Accesorios e cabos / Accesorios y cables		-	-	-	4600	

Klettern im Gebäude

Climbing in the building / Élevées et hissage dans le bâtiment

Pure varianti di gru allungabili / Subida no edificio

Trepado dentro del edificio

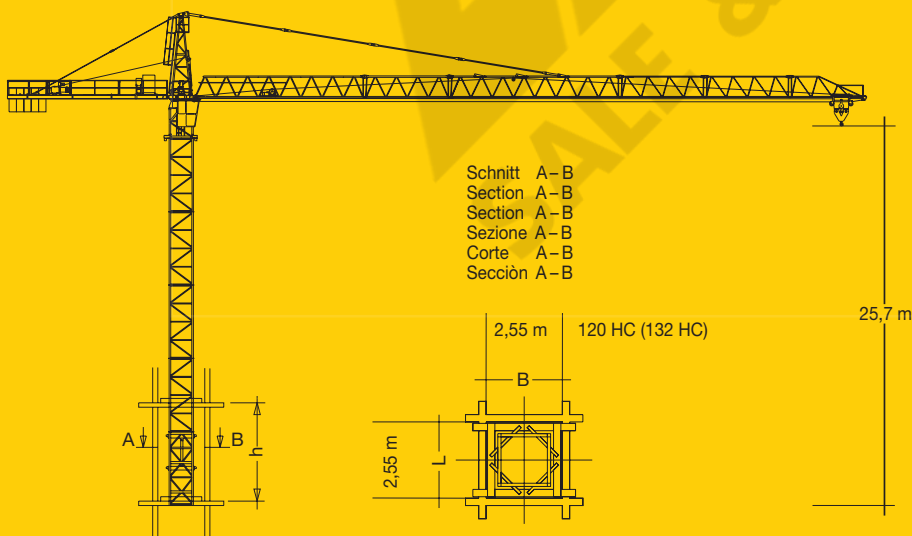



Datenblatt Nr. 121 P – 3318 H1 B3 DIN 15018 • BGL 2112-0080 / FEM (Section 1) Krangruppe A3 • 03.98

Data sheet / Feuille de caractéristiques

Foglio caratteristiche tecniche

Folha de características técnicas / Hoja de características

**Konstruktionsänderungen vorbehalten! / Subject to alterations!
Sous réserves de modifications! / Si fa riserva di modifiche!
Salvo modificação da construção! / ¡Sujeto a modificaciones!**

Printed in Germany.



Nehmen Sie Kontakt auf mit

Please contact

Mettez-vous en rapport avec

LIEBHERR-WERK BIBERACH GMBH, Postfach 1663, D-88396 Biberach an der Riß

☎ (0 73 51) 41-0, Fax (0 73 51) 4 12 25, <http://www.Liebherr.com>, E-Mail: info@lbc.liebherr.com