

Turmdrehkran

Tower Crane / Grue à tour / Gru a torre
Grúa torre / Guindaste de torre

280 EC-H 16 FR.tronic®

280 EC-H 16 Litronic®

280 EC-H 12 FR.tronic®
280 EC-H 12 Litronic®

280 EC-H 16 FR.tronic®
280 EC-H 16 Litronic®

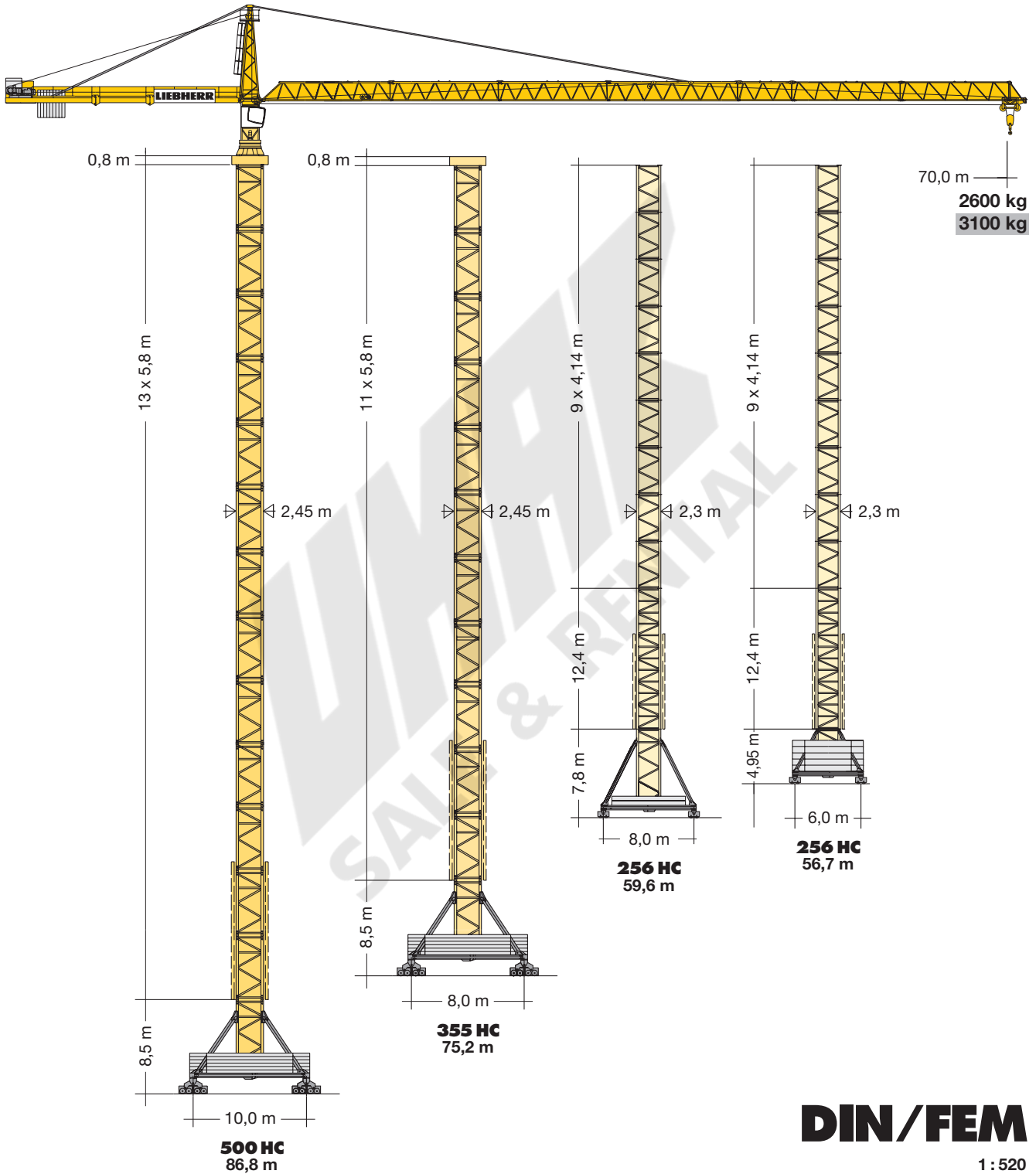

DIN/FEM

1 : 520

LIEBHERR

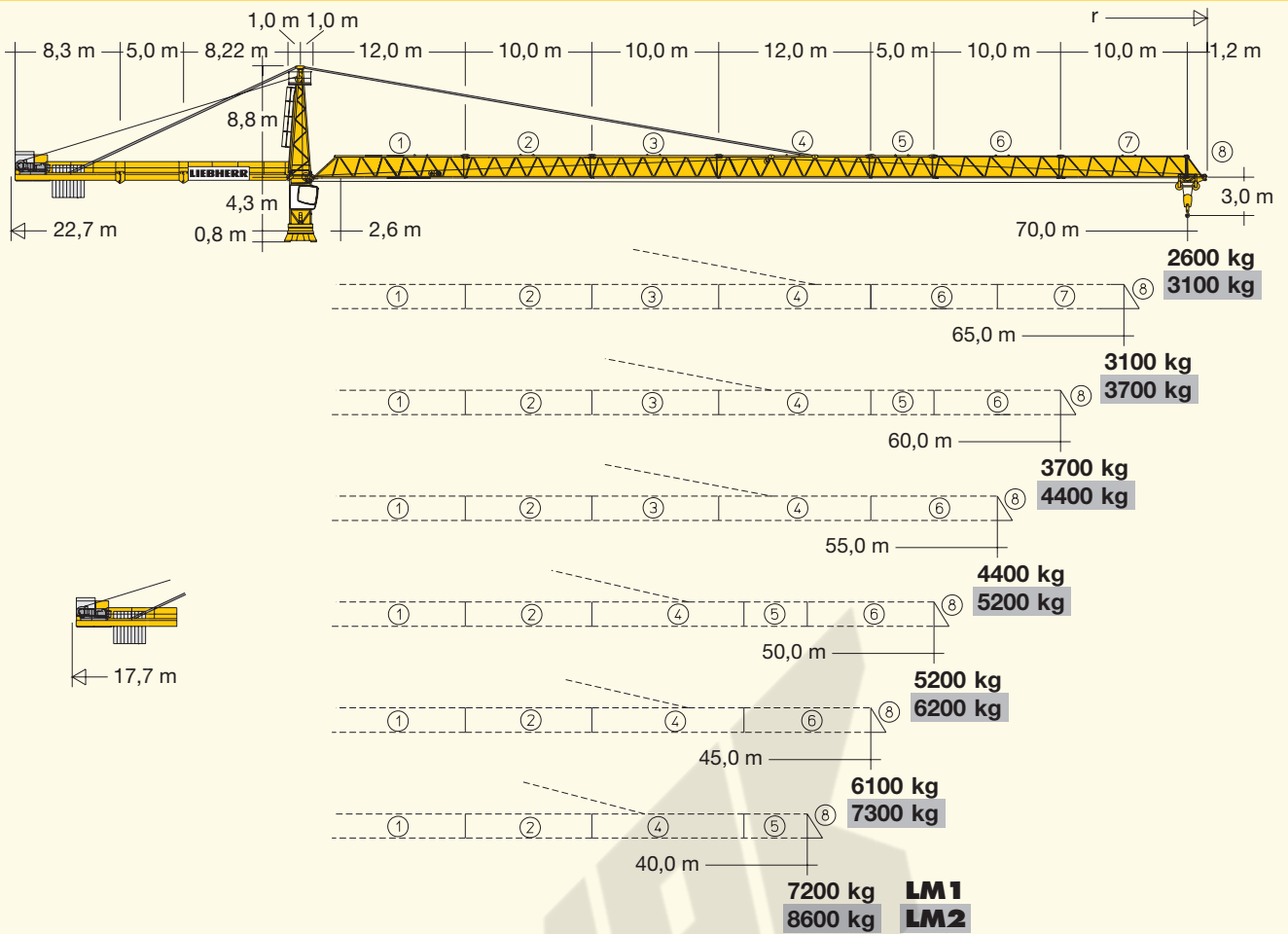

Hubhöhe

Hoisting height / Hauteur sous crochet / Altezza di sollevamento / Altura bajo gancho / Altura de montagem

	256 HC		355 HC		500 HC	
13	-	-	-	-	78,7*	86,8*
12	-	-	-	-	72,9	81,0
11	-	-	-	-	67,1	75,2
10	-	-	-	-	61,3	69,4
9	52,0**	56,7**	52,0**	59,6**	55,5	63,6
8	47,9**	52,6**	47,9**	55,5**	49,7	57,8
7	43,7	48,4	43,7	51,3	43,9	52,0
6	39,6	44,3	39,6	47,2	38,1	46,2
5	35,4	40,1	35,4	43,0	32,3	40,4
4	31,3	36,0	31,3	38,9	26,5	34,6
3	27,2	31,9	27,2	34,8	20,7	28,8
2	23,0	27,7	23,0	30,6	14,9	23,0
1	18,9	23,6	18,9	26,5	9,1	17,2
0	14,7	19,4	14,7	22,3	3,3	11,4
	m		m		m	

* xx **LM 2** Nicht möglich. / Not possible. / Pas possible. / Non possibile. / No posible. / Nao é possível.

** **Weitere Hubhöhen, Auslegerlängen sowie Klettern im Gebäude auf Anfrage.** / Further hoist heights and jib lengths as well as climbing inside the building on request. / Autres hauteurs sous crochet et longueurs de flèche ainsi que hissage dans le bâtiment sur demande. / Ulteriori altezze gancho, lunghezze braccio così come telescopaggio all'interno dell'edificio: su richiesta. / Para alturas bajo gancho superiores, otros alcances y trepado en el interior del edificio, consultar. / Outras alturas de elevação, comprimentos de lança e subida no edifício: sob consulta..

Ausladung und Tragfähigkeit

Radius and capacity / Portée et charge / Sbraccio e portata / Alcances y cargas / Alcance e capacidade de carga

		280 EC-H 16 FR.tronic®											
m	r	m/kg	m/kg										
			20,0	25,0	30,0	35,0	40,0	45,0	50,0	55,0	60,0	65,0	70,0
70,0 (r=71,6)		2,6-19,0 14000	13230	10220	8230	6820	5760	4940	4280	3750	3300	2920	2600
65,0 (r=66,6)		2,6-19,8 14000	13820	10690	8620	7150	6050	5190	4510	3960	3490	3100	
60,0 (r=61,6)		2,6-18,3 16000	14460	11200	9040	7510	6360	5470	4760	4180	3700		
55,0 (r=56,6)		2,6-19,0 16000	15060	11680	9440	7850	6660	5740	5000	4400			
50,0 (r=51,6)		2,6-19,5 16000	15570	12080	9770	8130	6910	5960	5200				
45,0 (r=46,6)		2,6-19,9 16000	15890	12340	9990	8320	7070	6100					
40,0 (r=41,6)		2,6-20,2 16000	16000	12550	10160	8470	7200						

LM 1

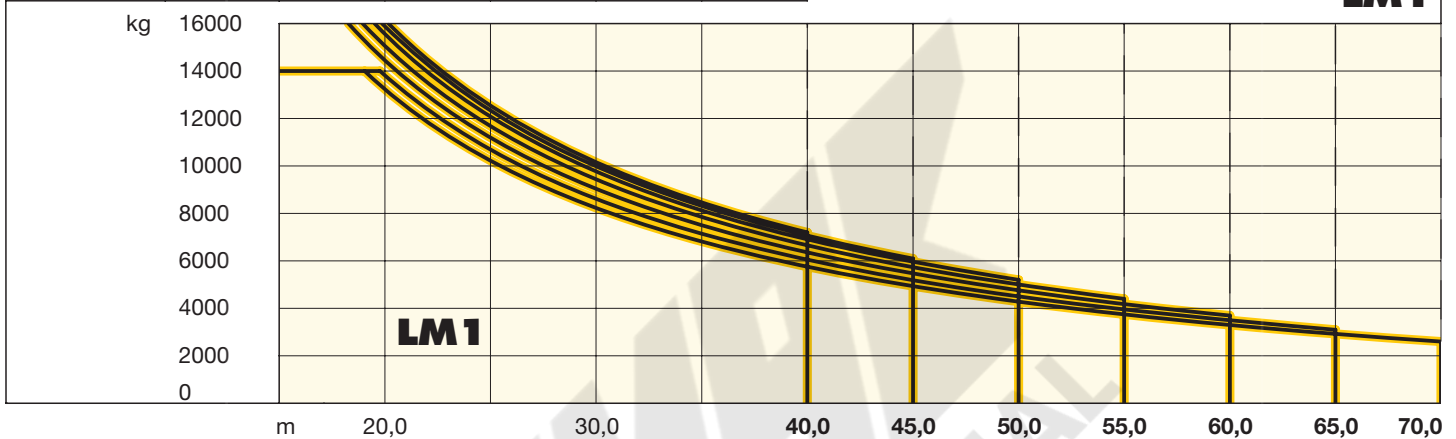

Antriebe FR.tronic®/Litronic®

Driving units / Mécanismes d'entraînement / Azionamenti / Mecanismos / Mecanismos

65 kW FU
WIW 280 MZ 404

197,0 m
max. 393,0 m**

↔ **stufenlos** / stepless / régl. continu
régl. progressive / sin escalones / sem degraus
kg m/min

1 16000 0 ↔ 21
3300 0 ↔ 72

↔ **stufenlos** / stepless / régl. continu
régl. progressive / sin escalones / sem degraus
kg m/min

5 **Lagen**
Layers
Couches
Strati
Camadas
Capas

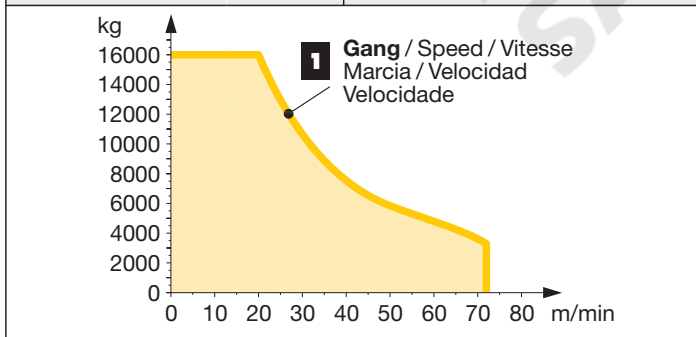

65 kW FU
WIW 280 VZ 405

219,0 m
max. 437,0 m**

↔ **stufenlos** / stepless / régl. continu
régl. progressive / sin escalones / sem degraus
kg m/min

1 16000 0 ↔ 21
3300 0 ↔ 73

2 9400 0 ↔ 34
1100 0 ↔ 128

↔ **stufenlos** / stepless / régl. continu
régl. progressive / sin escalones / sem degraus
kg m/min

5 **Lagen**
Layers
Couches
Strati
Camadas
Capas

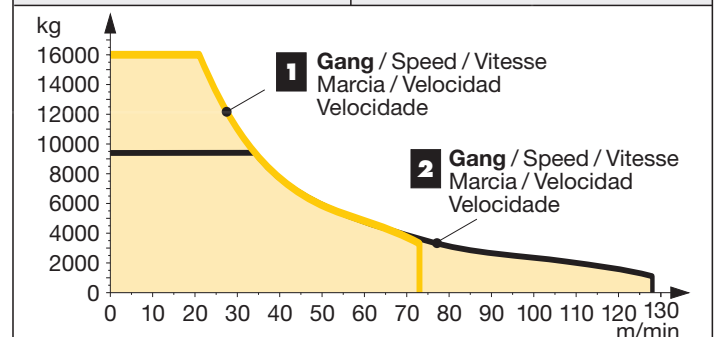

** Weitere Hublastdaten: siehe Betriebsanleitung. / Further hoist data: see instruction manual. / Autres données de la charge de levage: voir manuel d'instruction. / Altri dati sui carichi sollevati: consultare il manuale d'istruzione. / Alturas bajo grancho superiores según manual. / Outras tabelas de carga: consultar manual de instruções.

Ausladung und Tragfähigkeit

Radius and capacity / Portée et charge / Sbraccio e portata / Alcances y cargas / Alcance e capacidade de carga

		280 EC-H 16 Litronic®											
m	r	m/kg	m/kg										
			20,0	25,0	30,0	35,0	40,0	45,0	50,0	55,0	60,0	65,0	70,0
70,0	(r=71,6)	2,6-21,3 14000	14000	11640	9410	7820	6640	5720	4980	4380	3880	3460	3100
65,0	(r=66,6)	2,6-22,3 14000	14000	12270	9930	8270	7030	6060	5290	4670	4140	3700	
60,0	(r=61,6)	2,6-20,7 16000	16000	12890	10450	8710	7410	6410	5600	4950	4400		
55,0	(r=56,6)	2,6-21,4 16000	16000	13460	10920	9110	7760	6720	5880	5200			
50,0	(r=51,6)	2,6-22,3 16000	16000	14100	11450	9570	8160	7070	6200				
45,0	(r=46,6)	2,6-22,9 16000	16000	14510	11800	9860	8420	7300					
40,0	(r=41,6)	2,6-23,3 16000	16000	14800	12040	10070	8600						

LM1 + LM2

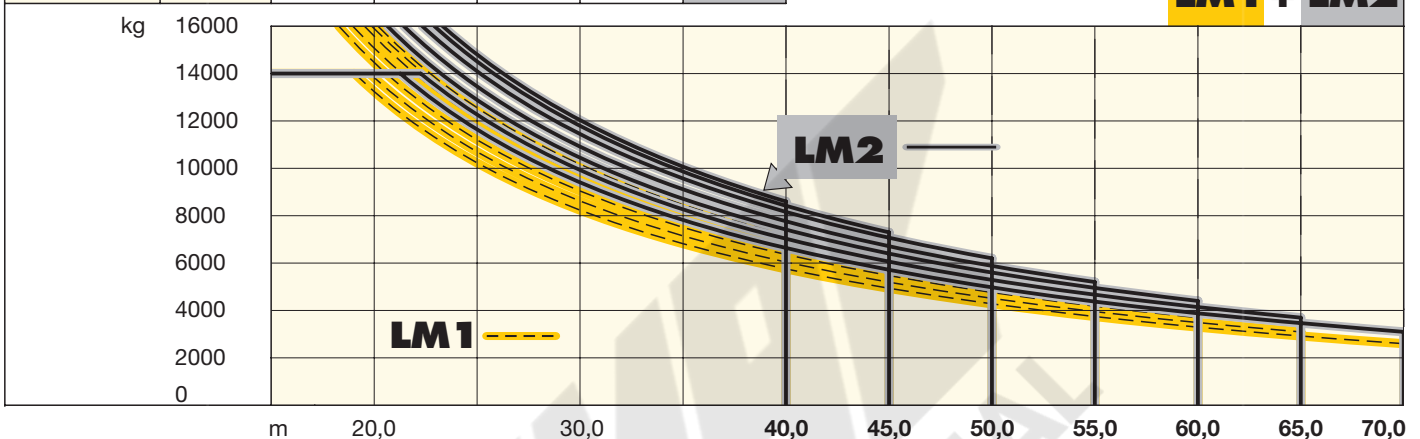

Antriebe FR.tronic®/Litronic®

Driving units / Mécanismes d'entraînement / Azionamenti / Mecanismos / Mecanismos

110 kW FU
WIW 300 VZ 411
6 **Lagen**
Layers
Couches
Strati
Camadas
Capas

270,0 m
max. 437,0 m**











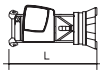

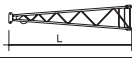





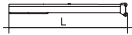



















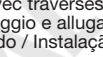

↔ **stufenlos** / stepless / régl. continu
regl. progressiva / sin escalones / sem degraus
kg m/min

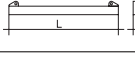

1	16000	0 ↔	35
	8000	0 ↔	65
2	9400	0 ↔	56
	4100	0 ↔	113
3	5200	0 ↔	94
	1700	0 ↔	188

	U/min 0 ↔ 0,7 sl./min tr./min	2 x 7,5 kW FU
	0 ↔ 91,0 m/min	10,5 kW FU
	25,0 m/min	4 x 7,5 kW 500 HC, 355 HC (550 HC, 390 HC) 2 x 7,5 kW 256 HC (290 HC)
	kVA	65 kW FU 65 kW FU 110 kW FU 90,0 90,0 131,0

LM 2 Abweichende Geschwindigkeiten und Betriebsbedingungen.
Variant speeds and service conditions. / Vitesses et conditions de fonctionnement différentes. / Differenti velocità e condizioni di funzionamento. / Otras velocidades y características de funcionamiento. / Outras velocidades e características de funcionamento.

Litronic: kVA reduzierbar bei zu geringer Netz-Anschlussleistung, siehe BAL. / kVA can be reduced in case of too little power of the mains, see instruction manual. / kVA peut être réduit en cas de trop faible puissance du réseau, voir manuel d'instruction. / kVA riducibili in caso di potenza di rete ridotta (si veda manuale uso e manutenzione) / kVA variable para potencia de red demasiado pequeña, ver Manual de instrucciones. / kVA reduzível no caso de capacidade da rede elétrica muito baixa, ver manual de instruções.

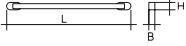
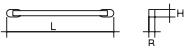
Kranoberteil		Upper part of crane / Partie supérieure de grue / Parte superiore della gru		L (m)	B (m)	H (m)	kg*			
Pos. Item Rep. Voce Pos. Ref.	Anz. Qty. Qta. Cant.									
1	1	Drehbühne / Slewing platform / Ensemble mât-cabine / Piattaforma girevole / Conjunto plataforma de giro / Plataforma giratória				5,49	2,74	2,68	10120	
2	1	Turmspitze / Tower head Porte-flèche / Cuspide / Cabeza de torre Cabeça de apoio de lança				9,09	1,70	1,92	2800	
3	1	Gegenausleger-Kopfstück / Counter-jib head Pointe de contre-flèche / Testa di controbraccio Tramo punta de contrapluma / Cabeça de contra-lança				8,48	2,45	0,92	3050	
4	1	Gegenausleger-Anlenkstück / Counter-jib heel section / Pied de contre-flèche / Settore articolato di controbraccio / Tramo primero-contrapluma Base articulada da contra-lança				8,44	1,77	0,92	2800	
5	1	Gegenausleger-Zwischenstück / Intermediate counter-jib section / Élément interm. de contre-flèche Spezzone di controbraccio / Tramo intermedio de contrapluma / Peça suplementar da contra-lança				5,22	1,76	0,92	1550	
6	1	Ausleger-Anlenkstück / Jib heel section Pied de flèche / Settore articolato di braccio Pluma tramo primero / Base articulada de lança				12,26	1,86	1,96	① 3300	
7	1	Ausleger-Zwischenstück / Intermediate jib section Elément intermédiaire de flèche / Spezzone di braccio Tramo intermedio pluma / Peça suplementar da lança				10,26 12,28 5,32 10,27 10,26	1,63 1,63 1,63 1,63 1,63	1,87 1,86 1,86 1,86 1,84	②+③ 1950 ④ 2260 ⑤ 820 ⑥ 1250 ⑦ 840	
8	1	Ausleger-Kopfstück / Jib head section Pointe de flèche / Punta freccia Tramo punta de pluma / Cabeça de lança				1,70	1,88	2,05	⑧ 280	
9	1	Laufkatze und Lasthaken / Trolley and hook Chariot de distribution et crochet / Carrello con gancio Carrito y gancho / Carro de ponte e gancho				1,89	1,83	1,57	1520	
10	1	Hubwerkseinheit / Hoist gear unit / Treuil de levage Gruppo meccanismo sollevamento / Mecanismo de elevación / Grupo de mecanismo elevatório				280 VZ	2,30	2,70	1,65	5800
Turm		Tower / Mât / Torre								
11	9	Turmstück / Tower section Elément de mât / Elemento di torre Tramo torre / Torre				256 HC (290 HC) 355 HC (390 HC) 500 HC (550 HC)	4,14 6,28 6,28	2,30 2,45 2,45	2,30 2,45 2,45	2300 5050 6490
12	1	Turmstück lang / Long tower section Elément de mât long / Elemento di torre, lungo Tramo de torre largo / Peça de torre, comprida				256 HC (290 HC)	12,42	2,30	2,30	5770
13	1	Grundturmstück / Base tower section Mât de base / Elemento di torre base Tramo base / Peça de base de torre				256 HC (290 HC)	8,85 (12,42)	2,30 (2,30)	2,30 (2,30)	4830 (7935)
Klettereinrichtung		Climbing equipment / Equipement de télescopage / Attrezzatura per allungamento della gru								
14	1	Führungstück kpl., geteilt / Guide section cpl., split / Cage télescopique cpl., dévisée / Gabbia di sopraelevazione compl., suddivisa / Torre de montaje, dividida / Peça de guia, subdividida				256 HC (290 HC) 355 HC (390 HC) 500 HC (550 HC)	8,39 12,39 12,39	2,68 2,75 2,75	2,58 (3,04) 1,58 1,58	4600 8950 8950
15	1	Hydraulikanlage, Stütz- und Klettertraverse / Hydraulic unit, supporting and climbing cross members / Système hydraulique avec traverses d'appui et de télescopage / Sistema idraulico, traversa di appoggio e allungamento gru / Sistema hidráulico com travessa de apoio y trepado / Instalação hidráulica, travessa de apoio e subida				256 HC (290 HC) 355 HC (390 HC) 500 HC (550 HC)	2,10 2,10 2,10	1,25 1,10 1,10	1,00 1,00 1,00	1150 1710 1710
Unterwagen		Undercarriage / Châssis / Carro della gru								
16	4	Ausgleichsschwinge mit Schwingenlager / Pivot for wheel box / Chape pour bogie / Bilanciere di equilibratura con cuscinetto bilanciante / Balancim Balancim com suporte				355 HC (390 HC) 500 HC (550 HC)	1,60	0,72	1,48	1390
17	2	Fahrschemel mit Antrieb / Rail bogie with drive Bogie moteur / Telaio con gruppo propulsore Caja rodillo motriz / Quadro sem grupo de propulsão				256 HC (290 HC) 355 HC (390 HC) 500 HC (550 HC)	1,63 (1,46) 1,40 1,45	0,92 (0,84) 0,75 0,82	0,95 (0,87) 0,65 0,72	1690 (920) 920 1690
18	2	Fahrschemel ohne Antrieb / Rail bogie without drive / Bogie fou / Telaio senza gruppo propulsore / Caja rodillo conducido / Quadro com grupo de propulsão				256 HC (290 HC) 355 HC (390 HC) 500 HC (550 HC)	1,37 (1,15) 1,10 1,30	0,62 (0,60) 0,60 0,40	0,95 (0,87) 0,65 0,72	1340 (880) 880 1340
19	1	Tragholm lang / Long support arm Longeron long / Longherone lungo Brazo soporte largo / Travessa comprida				256 HC (290 HC) 355 HC (390 HC) 500 HC (550 HC)	9,10 (11,85) 11,82 7,32	0,80 (0,82) 0,92 0,92	0,80 (0,80) 0,93 0,93	1650 (2200) 3515 2330
20	2	Tragholm kurz / Short support arm Longeron court / Longherone corto Brazo soporte corto / Travessa curta				256 HC (290 HC) 355 HC (390 HC) 500 HC (550 HC)	4,45 (5,58) 5,74 7,14	0,77 (0,65) 0,80 0,80	0,77 (0,77) 0,90 0,90	800 (1035) 1600 2135

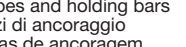
Pos. Item Rep Voce Pos. Ref.	Anz. Qty. Qté. Qta. Cant. Cant.			L (m)	B (m)	H (m)	kg*	
21	2 + 2	Randträger / Border support Traverse / Supporti base Traviesa / Apoio de bordo		256 HC (290 HC)	5,46 – 5,40	0,11 – 0,18	0,16 – 0,38	175 – 525
				355 HC (390 HC)	(7,52 – 7,46)	(0,1 – 0,17)	(0,1 – 0,38)	(366 – 912)
				500 HC (550 HC)	7,30	0,14	0,14	340
22	4	Stützholm / Support strut Hauban de châssis / Correnti di appoggio Tirante vertical / Travessa de apoio		256 HC (290 HC)	4,14 (6,55)	0,18 (0,22)	0,25 (0,25)	320 (600)
				355 HC (390 HC)	6,06	0,26	0,34	862
				500 HC (550 HC)	6,98	0,26	0,34	1140
23	1	Unterswagen-Turmstück / Undercarriage tower section / Mât de châssis / Elemento di torre del carro / Tramo de carro / Peça de torre do chassis		256 HC (290 HC)	3,73 (6,70)	2,62 (2,53)	2,62 (2,53)	2550 (3800)
				355 HC (390 HC)	6,61	2,44	2,44	7475
				500 HC (550 HC)	6,61	2,44	2,44	7930
24		Kleinteile, Seile und Abspannungen / Small parts, ropes and holding bars Accessoires, câbles et tirants / Accessori, funi e attrezzi di ancoraggio Despieces, cables y tirantes / Acessórios, cabos e peças de ancoragem		256 HC (290 HC)	9,00	1,60	1,00	4000
				355 HC (390 HC)				
				500 HC (550 HC)				

() **Angaben in Klammern gelten für 8 m-Unterswagen.** / The data in brackets are valid for an undercarriage of 8 m. / Les données techniques indiquées entre parenthèses sont valables pour un châssis de 8 m. / Caratteristiche in (..) valgono per carro di 8 m. / Los datos entre paréntesis son válidos para carro de 8 m. / Características em (..) válidas pelo chassis de 8 m.

* **Einzelgewichte.** / Single weights. / Poids individuels. / Pesì di componenti. / Pesos unitarios. / Pesos de peças componentes.

Konstruktionsänderungen vorbehalten!

Subject to alterations! / Sous réserves de modifications!
Si fa riserva di modifiche! / ¡Sujeto a modificaciones!
Salvo modificação da construçao!

Sämtliche Angaben erfolgen ohne Gewähr. / This information is supplied without liability.

Ces renseignements sont sans garantie. / Le indicazioni contenute si intendono salvo errori ed omissioni.
Declinamos toda responsabilidad derivada de la información proporcionada. / Declinamos qualquer
responsabilidade quanto à informação fornecida.