

Turmdrehkran

Tower Crane / Grue à tour / Gru a torre
Grúa torre / Guindaste de torre

245 EC-H 12 FR.tronic®

245 EC-H 12 Litronic®

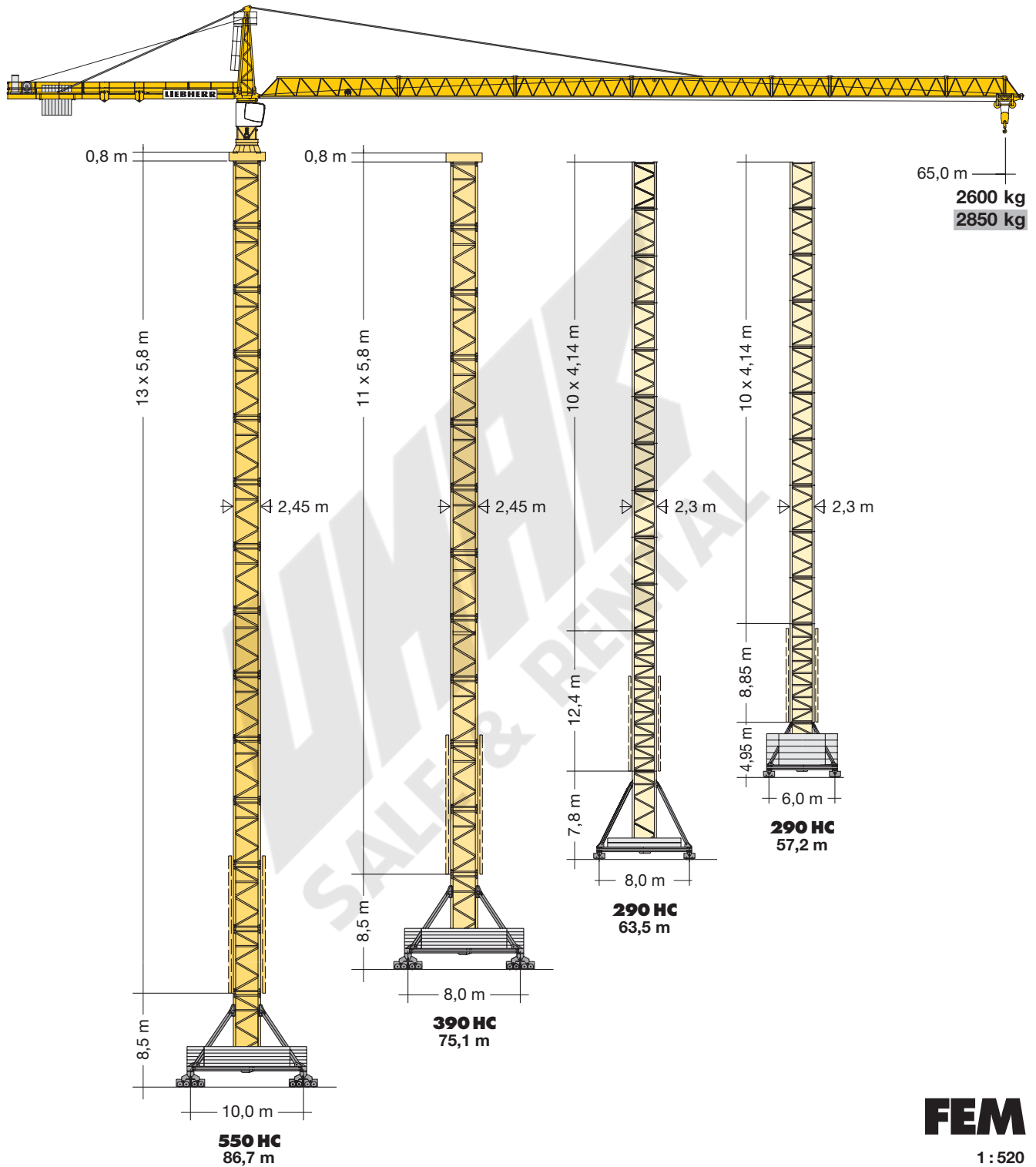

FEM

1:520

LIEBHERR

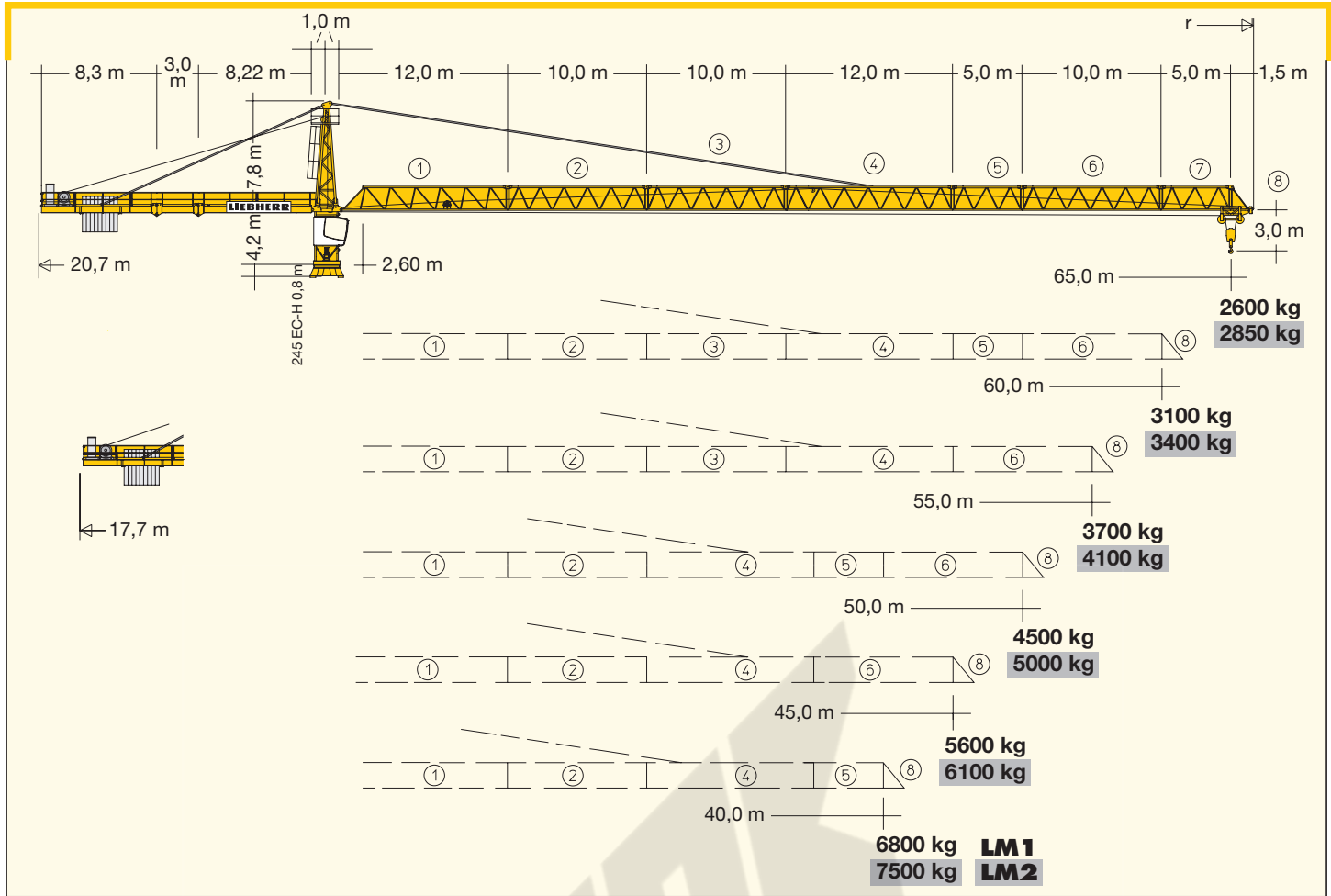

Hubhöhe

Hoisting height / Hauteur sous crochet / Altezza di sollevamento / Altura bajo gancho / Altura de montagem

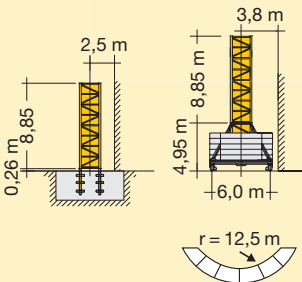
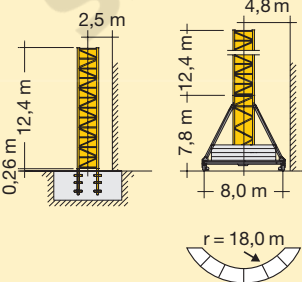
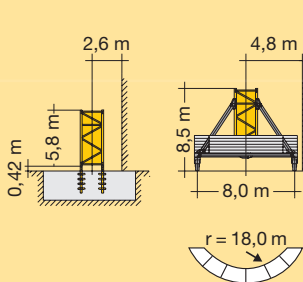
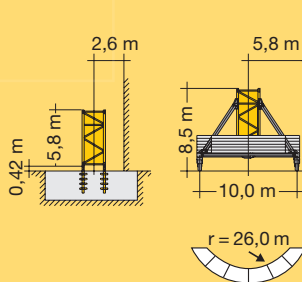
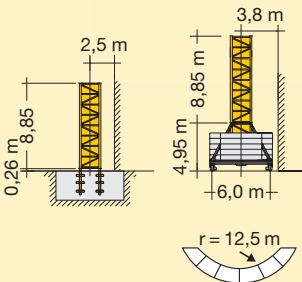
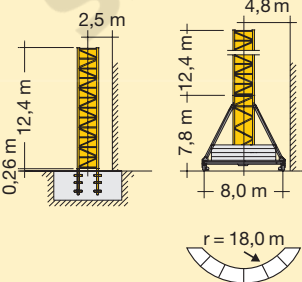
	290 HC		390 HC		550 HC	
13	-	-	-	-	-	-
12	-	-	-	-	-	-
11	-	-	-	-	66,9*	75,1*
10	52,5**	57,2**	56,0*	63,5*	61,1	69,3
9	48,4**	53,1**	51,9	59,4	55,3	63,5
8	44,3	49,0	47,7	55,3	49,5	57,7
7	40,1	44,8	43,6	51,1	43,7	51,9
6	36,0	40,7	39,4	47,0	37,9	46,1
5	31,8	36,5	35,3	42,8	32,1	40,3
4	27,7	32,4	31,2	38,7	26,3	34,5
3	23,6	28,3	27,0	34,6	20,5	28,7
2	19,4	24,1	22,9	30,4	14,7	22,9
1	15,3	20,0	18,7	26,3	8,9	17,1
0	11,1	15,8	14,6	22,1	3,1	11,3
	m	m	m	m	m	m
						

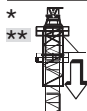
*  **LM 2 Nicht möglich.** / Not possible. / Pas possible. / Non possibile. / No possible. / Nao é possível.

**  **Weitere Hubhöhen, Auslegerlängen sowie Klettern im Gebäude auf Anfrage.** / Further hoist heights and jib lengths as well as climbing inside the building on request. / Autres hauteurs sous crochet et longueurs de flèche ainsi que hissage dans le bâtiment sur demande. / Ulteriori altezze gancho, lunghezze braccio così come telescopaggio all'interno dell'edificio: su richiesta. / Para alturas bajo gancho superiores, otros alcances y trepado en el interior del edificio, consultar. / Outras alturas de elevação, comprimentos de lança e subida no edifício: sob consulta.

Ausladung und Tragfähigkeit

Radius and capacity / Portée et charge / Sbraccio e portata / Alcances y cargas / Alcance e capacidade de carga

		245 EC-H 12 FR.tronic®													
m	r	m/kg	m/kg												
			19,0	22,0	25,0	28,0	31,0	34,0	37,0	40,0	45,0	50,0	55,0	60,0	65,0
65,0	(r=66,6)	2,6-18,8 12000	11850	10050	8680	7620	6760	6050	5460	4960	4280	3730	3290	2910	2600
60,0	(r=61,6)	2,6-19,6 12000	12000	10560	9130	8020	7120	6380	5770	5240	4530	3960	3490	3100	
55,0	(r=56,6)	2,6-20,5 12000	12000	11090	9600	8430	7500	6730	6080	5530	4790	4190	3700		
50,0	(r=51,6)	2,6-21,7 12000	12000	11810	10230	9000	8000	7190	6500	5930	5130	4500			
45,0	(r=46,6)	2,6-23,3 12000	12000	12000	11080	9750	8680	7810	7070	6450	5600				
40,0	(r=41,6)	2,6-24,3 12000	12000	12000	11640	10250	9140	8220	7450	6800					

LM1

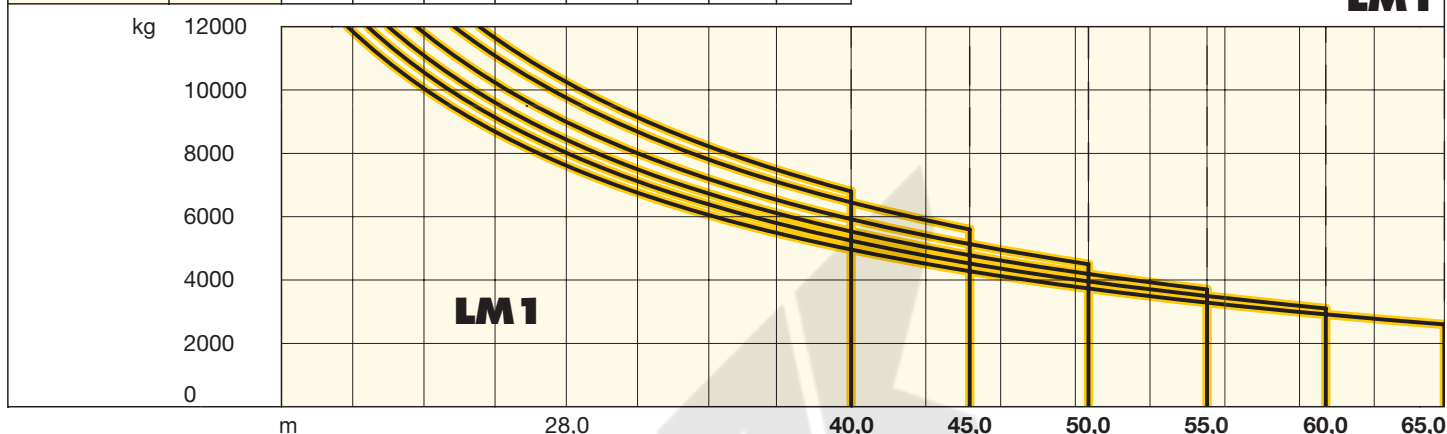

Antriebe FR.tronic®/Litronic®

Driving units / Mécanismes d'entraînement / Azionamenti / Mecanismos / Mecanismos

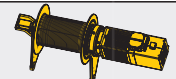

45 kW FU
WIW 260 MZ 402



173,0 m

max. 256,0 m**

↔ **stufenlos** / stepless / régl. continu
regl. progressiva / sin escalones / sem degraus
kg m/min

5 Lagen
Layers
Couches
Strati
Camadas
Capas

1	12000	0 ↔ 19
	1150	0 ↔ 94

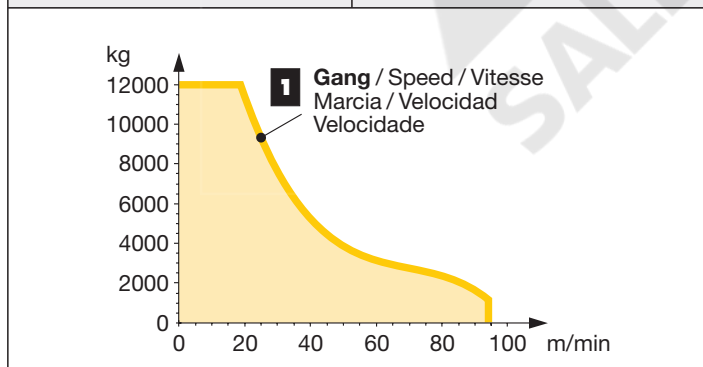



65 kW FU
WIW 280 MZ 401

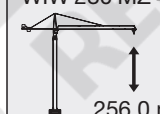

256,0 m

↔ **stufenlos** / stepless / régl. continu
regl. progressiva / sin escalones / sem degraus
kg m/min

7 Lagen
Layers
Couches
Strati
Camadas
Capas

1	12000	0 ↔ 27
	2300	0 ↔ 96

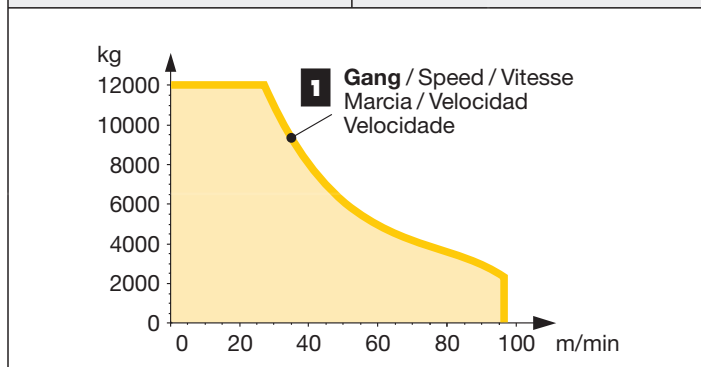

** Weitere Hublastdaten: siehe Betriebsanleitung. / Further hoist load data: see instruction manual. / Autres données de la charge de levage: voir manuel d'instruction. / Altri dati sui carichi sollevati: consultare il manuale d'istruzione. / Alturas bajo gráncho superiores según manual. / Outras tabelas de carga: consultar manual de instruções.

m	r	m/kg	245 EC-H 12 Litronic®												
			19,0	22,0	25,0	28,0	31,0	34,0	37,0	40,0	45,0	50,0	55,0	60,0	65,0
65,0	(r=66,6)	2,6-18,8 12000	11850	10050	8680	8200	7280	6530	5900	5370	4640	4060	3580	3190	2850
60,0	(r=61,6)	2,6-21,0 12000	12000	11390	9860	8660	7700	6910	6250	5690	4930	4320	3820	3400	
55,0	(r=56,6)	2,6-22,2 12000	12000	12000	10490	9230	8210	7380	6680	6090	5280	4630	4100		
50,0	(r=51,6)	2,6-23,6 12000	12000	12000	11240	9890	8810	7920	7180	6550	5690	5000			
45,0	(r=46,6)	2,6-25,0 12000	12000	12000	11980	10560	9410	8470	7680	7010	6100				
40,0	(r=41,6)	2,6-24,3 12000	12000	12000	11640	10250	9500	9040	8210	7500					

LM1 + LM2

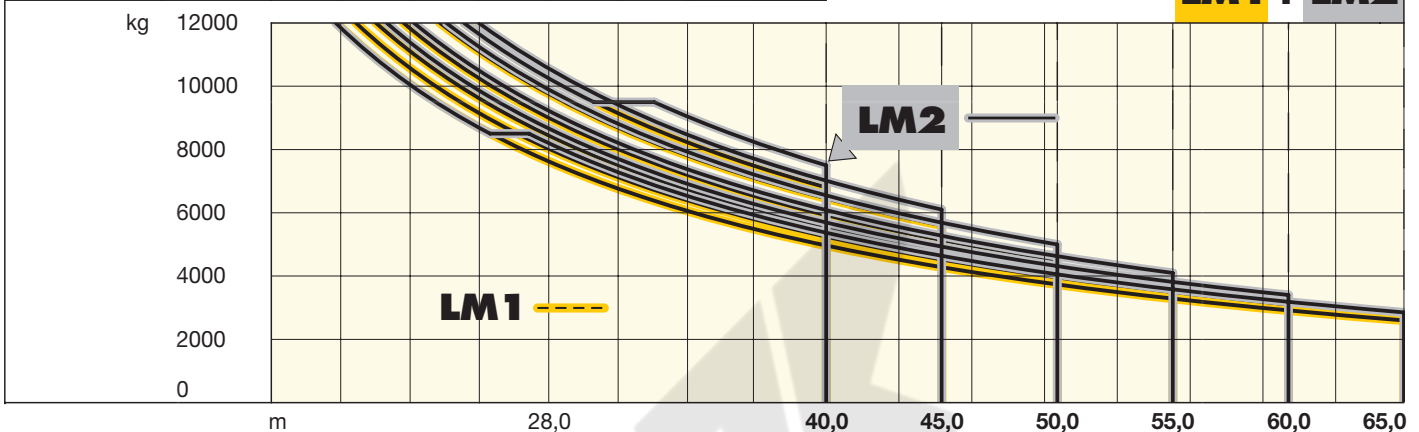

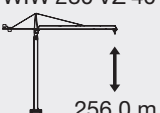

Antriebe FR.tronic®/Litronic®

Driving units / Mécanismes d'entraînement / Azionamenti / Mecanismos / Mecanismos

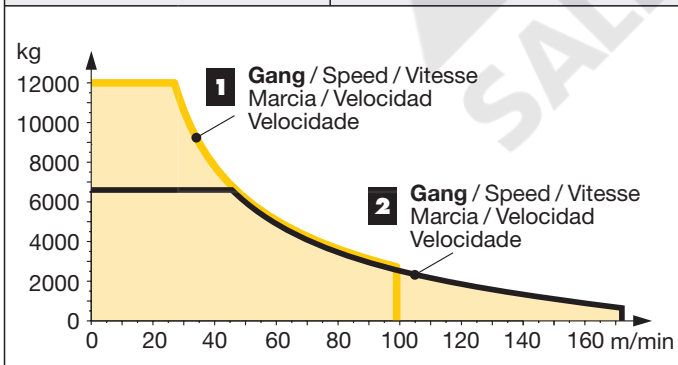



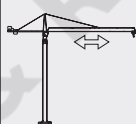

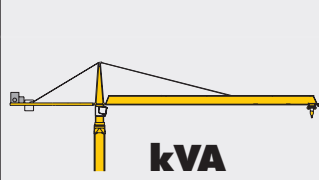





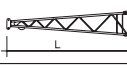





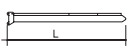



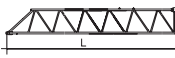

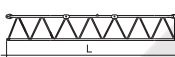

















	↔ stufenlos / stepless / régl. continu regl. progressiva / sin escalones / sem degraus kg m/min
65 kW FU WIW 280 VZ 401 7 Lagen Layers Couches Strati Camadas Capas	1 12000 0 ↔ 27 2300 0 ↔ 99
	2 6600 0 ↔ 48 650 0 ↔ 172

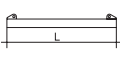

LM 2 Abweichende Geschwindigkeiten und Betriebsbedingungen. Variant speeds and service conditions. / Vitesses et conditions de fonctionnement différentes. / Differenti velocità e condizioni di funzionamento. / Otras velocidades y características de funcionamiento. / Outras velocidades e características de funcionamento.

	U/min 0 ↔ 0,7 sl./min tr./min	2 x 7,5 kW FU
	0 ↔ 110,0 m/min	7,5 kW FU
	25,0 m/min	4 x 7,5 kW (550 HC, 390 HC) 2 x 7,5 kW (290 HC)
	kVA	45 kW FU 65 kW FU 65 kW FU 63,0 86,0 86,0

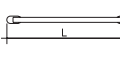
Litronic: kVA reduzierbar bei zu geringer Netz-Anschlussleistung, siehe BAL. / kVA can be reduced in case of too little power of the mains, see instruction manual. / kVA peut être réduit en cas de trop faible puissance du réseau, voir manuel d'instruction. / kVA riducibili in caso di potenza di rete ridotta (si veda manuale uso e manutenzione) / kVA variable para potencia de red demasiado pequeña, ver Manual de instrucciones. / kVA reduzível no caso de capacidade da rede elétrica muito baixa, ver manual de instruções.

Kranoberteil		Upper part of crane / Partie supérieure de grue / Parte superiore della gru	Parte superior grúa / Parte superior do guindaste	L (m)	B (m)	H (m)	kg*		
Pos. Item Ref.	Anz. Qty. Cant.	Drehbühne / Slewing platform / Ensemble mât-cabine / Piattaforma girevole / Conjunto plataforma de giro / Plataforma giratória			5,40	2,74	2,64	10120	
1	1								
2	1	Turmspitze / Tower head Porte-flèche / Cuspide / Cabeza de torre Cabeça de apoio de lança			7,90	1,62	1,80	2500	
3	1	Hubwerkseinheit / Hoist gear unit / Treuil de levage Gruppo meccanismo sollevamento / Mecanismo de elevación / Grupo de mecanismo elevatório			2,20	2,39	1,74	3300	
4	1	Gegenausleger-Kopfstück / Counter-jib head Pointe de contre-flèche / Testa di controbraccio Tramo punta de contrapluma / Cabeça de contra-lança			8,50	2,42	0,92	2850	
5	1	Gegenausleger-Anlenkstück / Counter-jib heel section Pied de contre-flèche / Settore articolato di controbraccio / Tramo primero-contrapluma Base articulada da contra-lança			8,44	1,77	0,92	2800	
6	1	Gegenausleger-Zwischenstück / Intermediate counter-jib section / Élément interm. de contre-flèche Spezzone di controbraccio / Tramo intermedio de contrapluma / Peça suplementar da contra-lança			3,22	1,76	0,92	950	
7	1	Ausleger-Anlenkstück / Jib heel section Pied de flèche / Settore articolato di braccio Pluma tramo primero / Base articulada de lança			12,26	1,86	1,96	① 2980	
8	1	Ausleger-Zwischenstück / Intermediate jib section Élément intermédiaire de flèche / Spezzone di braccio Tramo intermedio pluma / Peça suplementar da lança			10,40	1,63	1,85	② 1680	
1	10,40				1,63	1,85	③ 1610		
1	12,30				1,63	1,85	④ 1840		
1	5,30				1,63	1,85	⑤ 585		
1	10,40				1,63	1,85	⑥ 1100		
1	5,30	1,63	1,85	⑦ 400					
9	1	Ausleger-Kopfstück / Jib head section Pointe de flèche / Punta freccia Tramo punta de pluma / Cabeça de lança			1,70	1,84	2,05	⑧ 300	
10	1	Laufkatze und Lasthaken / Trolley and hook Chariot de distribution et crochet / Carrello con gancio Carrito y gancho / Carro de ponte e gancho			1,89	1,83	1,20	1150	
Turm		Tower / Mât / Torre							
11	9	Turmstück / Tower section Élément de mât / Elemento di torre Tramo torre / Torre			290 HC	4,14	2,30	2,30	2300
11	390 HC				6,28	2,45	2,45	5050	
13	550 HC				6,28	2,45	2,45	6480	
12	1	Turmstück lang / Long tower section Élément de mât long / Elemento di torre, lungo Tramo de torre largo / Peça de torre, comprida			290 HC	12,42	2,30	2,30	5770
13	1	Grundturmstück / Base tower section Mât de base / Elemento di torre base Tramo base / Peça de base de torre			290 HC	8,85 (12,42)	2,30 (2,30)	2,30 (2,30)	4830 (7940)
Klettereinrichtung		Climbing equipment / Equipement de télescopage / Attrezzatura per allungamento della gru							
		Equipo de trepado / Acsórios p. subida no edificio							
14	1	Führungsstück kpl., geteilt / Guide section cpl., split Cage télescopique cpl., devisée / Gabbia de sopraelevazione compl., suddivisa Torre de montaje, dividida / Peça de guia, subdividida			290 HC	8,39	2,68	2,58 (3,04)	5100
	390 HC				12,39	2,75	1,58	8300	
	550 HC				12,39	2,75	1,58	8300	
15	1	Hydraulikanlage, Stütz- und Klettertraverse / Hydraulic unit, supporting and climbing cross members / Systeme hydraulique avec traverses d'appui et de télescopage / Sistema idraulico, traversa di appoggio e allungamento gru Sistema hidráulico con traviesa de apoyo y trepado / Instalação hidráulica, travessa de apoio e subida			290 HC	2,10	1,25	1,00	1150
	390 HC				2,10	1,10	1,00	1810	
	550 HC				2,10	1,10	1,00	1810	
Unterwagen		Undercarriage / Châssis / Carro della gru							
		Carro con mástil / Carro de guindaste							
16	4	Ausgleichsschwinge mit Schwingenlager / Pivot for wheel box / Chape pour bogie / Bilanciere di equilibratura con cuscinetto bilanciere / Balançin Balançim com suporte			390 HC	1,60	0,72	1,48	1390
	550 HC								
17	2	Fahrschemel mit Antrieb / Rail bogie with drive Bogie moteur / Telaio con gruppo propulsore Caja rodillo motriz / Quadro sem grupo de propulsão			290 HC	1,63 (1,46)	0,92 (0,84)	0,95 (0,87)	1690 (920)
4	390 HC				1,40	0,75	0,65	920	
4	550 HC				1,45	0,82	0,72	1690	
18	2	Fahrschemel ohne Antrieb / Rail bogie without drive / Bogie fou / Telaio senza gruppo propulsore / Caja rodillo conducido / Quadro com grupo de propulsão			290 HC	1,37 (1,15)	0,62 (0,60)	0,95 (0,87)	1340 (880)
4	390 HC				1,10	0,60	0,65	880	
4	550 HC				1,30	0,40	0,72	1340	
19	1	Tragholm lang / Long support arm Longeron long / Longherone lungo Braço soporte largo / Travessa comprida			290 HC	9,10 (11,95)	0,80 (0,82)	0,80 (0,80)	1650 (2200)
1	390 HC				11,82	0,92	0,93	3515	
2	550 HC				7,32	0,92	0,93	2330	
20	2	Tragholm kurz / Short support arm Longeron court / Longherone corto Braço soporte corto / Travessa curta			290 HC	4,45 (5,58)	0,77 (0,65)	0,77 (0,77)	800 (1035)
	390 HC				5,74	0,80	0,90	1600	
	550 HC				7,14	0,80	0,90	2135	
21	2 + 2	Randträger / Border support Traverse / Supporti base Traviesa / Apoio de bordo			290 HC	5,46 - 5,40	0,11 - 0,18	0,16 - 0,38	175 - 525
	390 HC				(7,52 - 7,46)	(0,1 - 0,17)	(0,1 - 0,38)	(366 - 912)	
	550 HC				7,30	0,14	0,14	340	
					550 HC	9,30	0,14	0,14	510

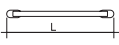
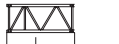
Pos. Item Rep. Voce Pos. Ref.	Anz. Qty. Qta. Qta. Cant. Cant.				L (m)	B (m)	H (m)	kg*
22	4	Stützholm / Support strut Hauban de châssis / Correnti di appoggio Tirante vertical / Travessa de apoio		290 HC	4,14 (6,55)	0,18 (0,22)	0,25 (0,25)	320 (600)
				390 HC	6,06	0,26	0,34	862
				550 HC	6,98	0,26	0,34	1140
23	1	Unterswagen-Turmstück / Undercarriage tower section / Mât de châssis / Elemento di torre del carro / Tramo de carro / Peça de torre do chassis		290 HC	3,73 (6,70)	2,62 (2,53)	2,62 (2,53)	2550 (3800)
				390 HC	6,61	2,44	2,44	7475
				550 HC	6,61	2,44	2,44	7930
24		Kleinteile, Seile und Abspannungen / Small parts, ropes and holding bars Accessoires, câbles et tirants / Accessori, funi e attrezzi di ancoraggio Despieces, cables y tirantes / Acessórios, cabos e peças de ancoragem		290 HC	9,00	1,60	1,00	5000
				390 HC				
				550 HC				

() **Angaben in Klammern gelten für 8 m-Unterswagen.** / The data in brackets are valid for an undercarriage of 8 m. / Les données techniques indiquées entre parenthèses sont valables pour un châssis de 8 m. / Caratteristiche in (...) valgono per carro di 8 m. / Los datos entre paréntesis son válidos para carro de 8 m. Características em (...) válidas pelo chassis de 8 m.

* **Einzelgewichte.** / Single weights. / Poids individuels. / Pesì di componenti. / Pesos unitarios. / Pesos de peças componentes.

WMAK
 SALE & RENTAL

Konstruktionsänderungen vorbehalten!
Subject to alterations! / Sous réserves de modifications!
Si fa riserva di modifiche! / ¡Sujeto a modificaciones!
Salvo modificação da construçao!

Sämtliche Angaben erfolgen ohne Gewähr. / This information is supplied without liability.
Ces renseignements sont sans garantie. / Le indicazioni contenute si intendono salvo errori ed omissioni.
Declinamos toda responsabilidad derivada de la información proporcionada. / Declinamos qualquer
responsabilidade quanto à informação fornecida.

121 P – 3917 FEM (Section 1) – Krangruppe A3 • 03.07/6

Printed in Germany.