

Turmdrehkran

Tower Crane / Grue à tour / Gru a torre
Grúa torre / Guindaste de torre

224 EC-H 8

224 EC-H 8 Litronic®

224 EC-H 8
224 EC-H 8 Litronic®

224 EC-H 12
224 EC-H 12 Litronic®

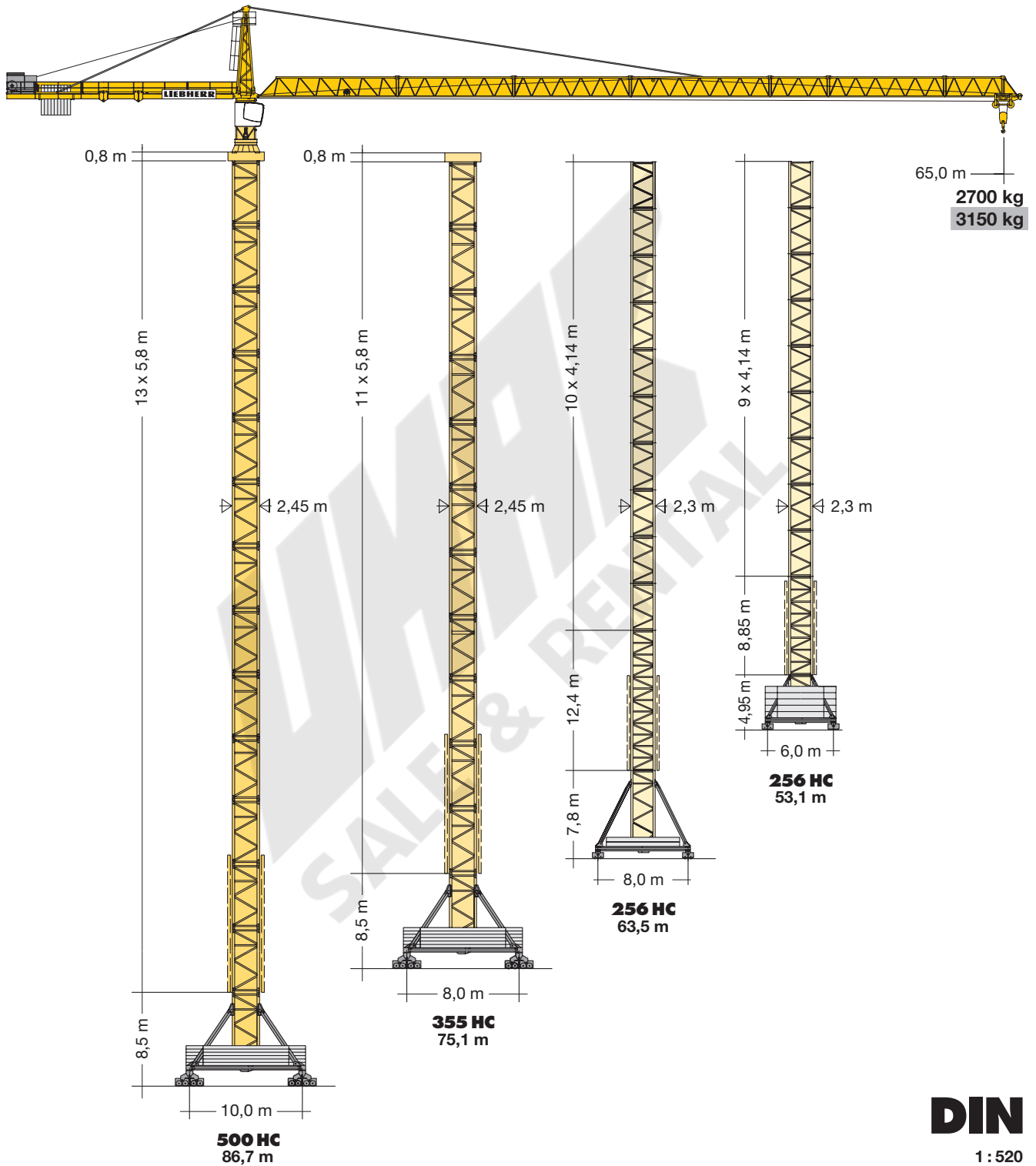

LIEBHERR

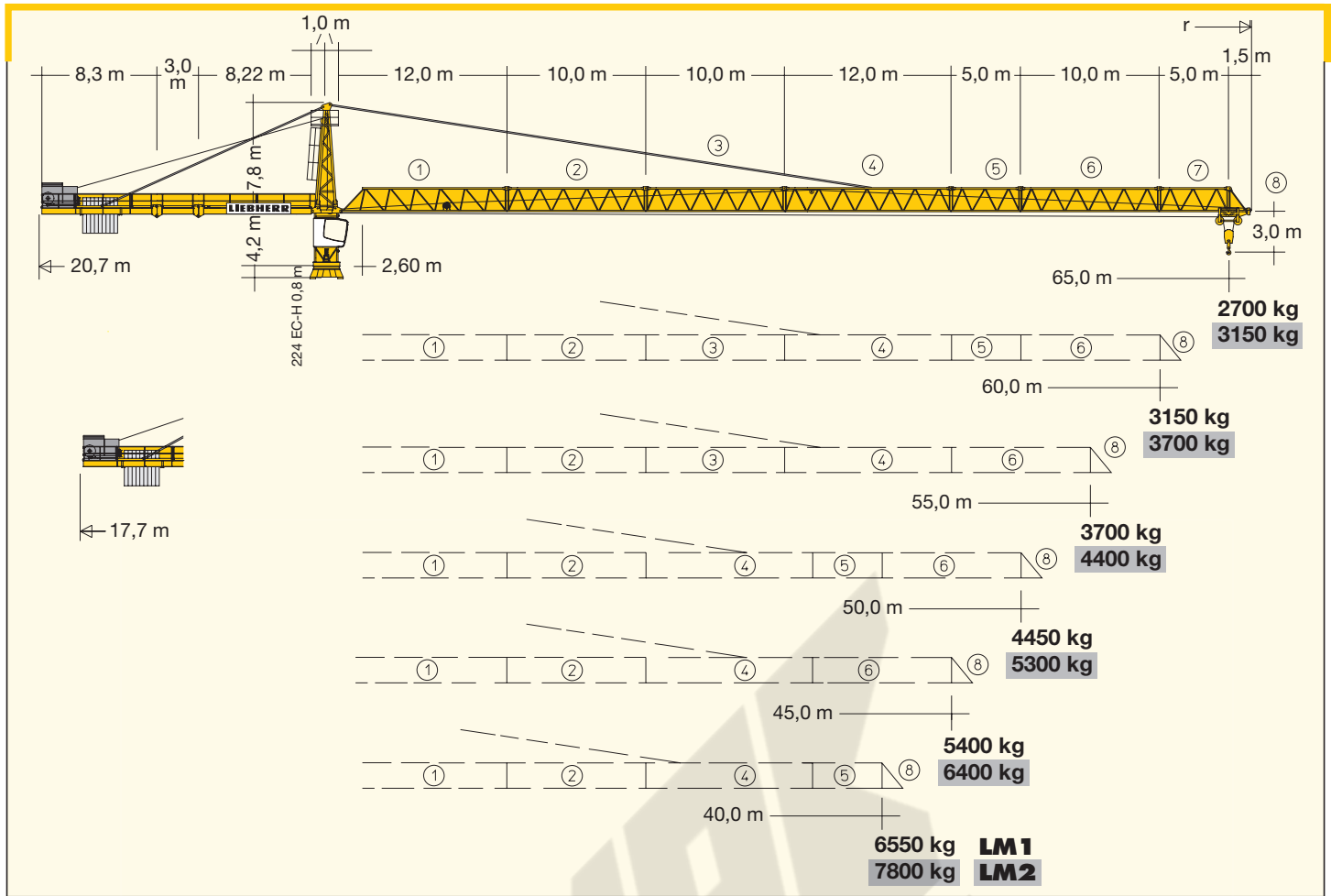

Hubhöhe

Hoisting height / Hauteur sous crochet / Altezza di sollevamento / Altura bajo gancho / Altura de montagem

	256 HC		355 HC		500 HC	
13	-	-	-	-	78,5*	86,7*
12	-	-	-	-	72,7	80,9
11	-	-	-	-	66,9	75,1
10	48,4*	56,0*	53,1*	56,6*	61,1	69,3
9	44,3	47,7	49,0	52,5	55,3	63,5
8	40,1	43,6	44,8	48,4	49,5	57,7
7	36,0	39,4	40,7	44,2	43,7	51,9
6	31,8	35,3	36,5	40,1	37,9	46,1
5	27,7	31,2	32,4	35,9	32,1	40,3
4	23,6	27,0	28,3	31,8	26,3	34,5
3	19,4	22,9	24,1	27,7	20,5	28,7
2	15,3	18,7	20,0	23,5	14,7	22,9
1	a) 11,1	b) 14,6	a) 15,8	b) 19,4	8,9	17,1
0					3,1	11,3
	m		m		m	

*



Weitere Hubhöhen sowie Klettern im Gebäude auf Anfrage. / Further hoist heights and climbing in the building on request.
 Hauteurs sous crochet plus élevées et hissage dans le bâtiment sur demande. / Altre altezze di sollevamento come pure varianti di gru allungabili: su richiesta. / Para alturas bajo gancho superiores y trepado en el interior del edificio, consultar. / Outras alturas de elevação e subida no edifício: conforme ao pedido.

Ausladung und Tragfähigkeit

Radius and capacity / Portée et charge / Sbraccio e portata / Alcances y cargas / Alcance e capacidade de carga

		224 EC-H 8																	
m	r	m/kg	m/kg																
			28,0	30,0	32,0	34,0	36,0	38,0	40,0	43,0	45,0	48,0	50,0	53,0	55,0	58,0	60,0	63,0	65,0
65,0	(r=66,6)	2,6-26,3 8000	7440	6880	6390	5960	5580	5240	4930	4530	4290	3960	3770	3510	3350	3130	3000	2810	2700
60,0	(r=61,6)	2,6-27,3 8000	7770	7190	6680	6230	5840	5480	5160	4740	4490	4160	3950	3680	3520	3290	3150		
55,0	(r=56,6)	2,6-28,4 8000	8000	7530	7000	6530	6120	5750	5420	4980	4720	4370	4160	3870	3700				
50,0	(r=51,6)	2,6-30,1 8000	8000	8000	7460	6970	6530	6140	5780	5320	5040	4670	4450						
45,0	(r=46,6)	2,6-31,9 8000	8000	8000	7960	7440	6980	6560	6190	5690	5400								
40,0	(r=41,6)	2,6-33,5 8000	8000	8000	8000	7870	7380	6940	6550										

LM 1

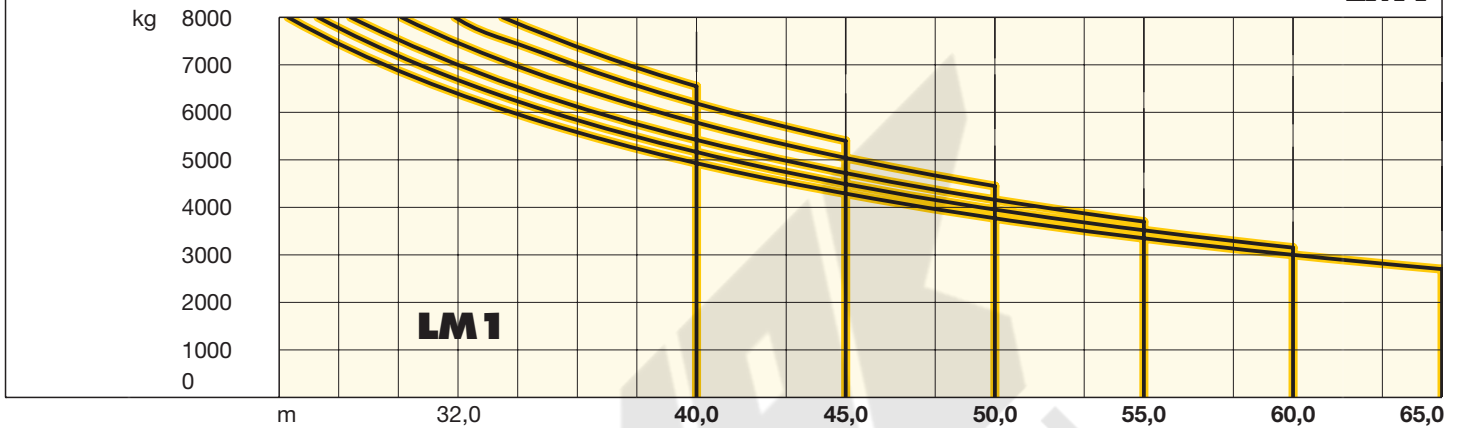

Antriebe

Driving units / Mécanismes d'entraînement / Azionamenti / Mecanismos / Mecanismos

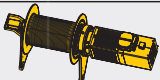

37 kW FR.tronic-FU
WIW 250 MZ 405

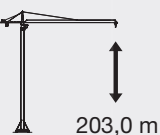



203,0 m

↔ **stufenlos** / stepless / régl. continu
regl. progressiva / sin escalones / sem degraus
kg m/min

1 8000 0 ↔ 24
700 0 ↔ 120

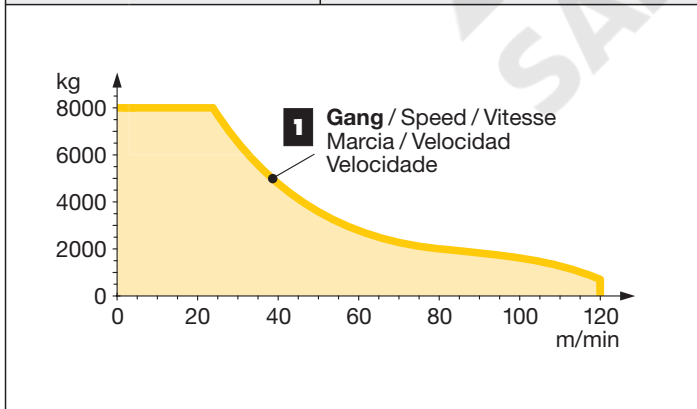
6 **Lagen**
Layers
Couches
Strati
Camadas
Capas





45 kW FR.tronic-FU
WIW 260 MZ 403

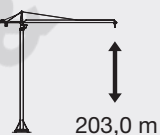

203,0 m

↔ **stufenlos** / stepless / régl. continu
regl. progressiva / sin escalones / sem degraus
kg m/min

1 8000 0 ↔ 29
850 0 ↔ 135

6 **Lagen**
Layers
Couches
Strati
Camadas
Capas

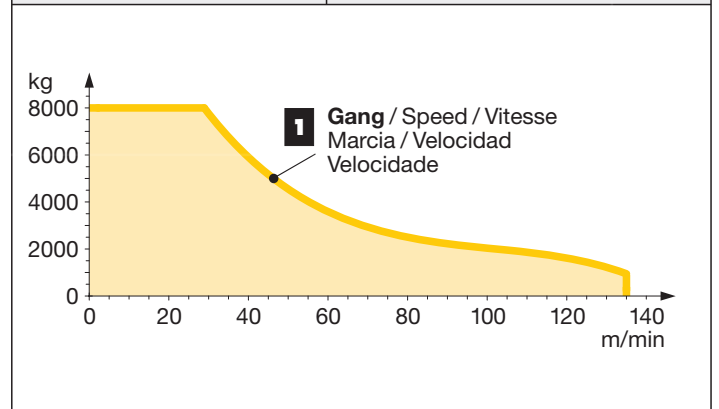

Ausladung und Tragfähigkeit

Radius and capacity / Portée et charge / Sbraccio e portata / Alcances y cargas / Alcance e capacidade de carga

		224 EC-H 8 Litronic®																	
m	r	m/kg	m/kg																
			28,0	30,0	32,0	34,0	36,0	38,0	40,0	43,0	45,0	48,0	50,0	53,0	55,0	58,0	60,0	63,0	65,0
65,0	(r=66,6)	2,6-29,5 8000	8000	7860	7310	6830	6400	6010	5670	5210	4940	4570	4360	4060	3880	3630	3480	3280	3150
60,0	(r=61,6)	2,6-31,0 8000	8000	8000	7720	7210	6760	6350	5990	5510	5230	4840	4610	4300	4120	3860	3700		
55,0	(r=56,6)	2,6-32,8 8000	8000	8000	8000	7670	7190	6770	6380	5870	5570	5170	4990	4600	4400				
50,0	(r=51,6)	2,6-34,8 8000	8000	8000	8000	8000	7710	7260	6850	6310	5990	5560	5300						
45,0	(r=46,6)	2,6-36,9 8000	8000	8000	8000	8000	8000	7750	7310	6740	6400								
40,0	(r=41,6)	2,6-39,1 8000	8000	8000	8000	8000	8000	8000	7800										

LM1 + LM2

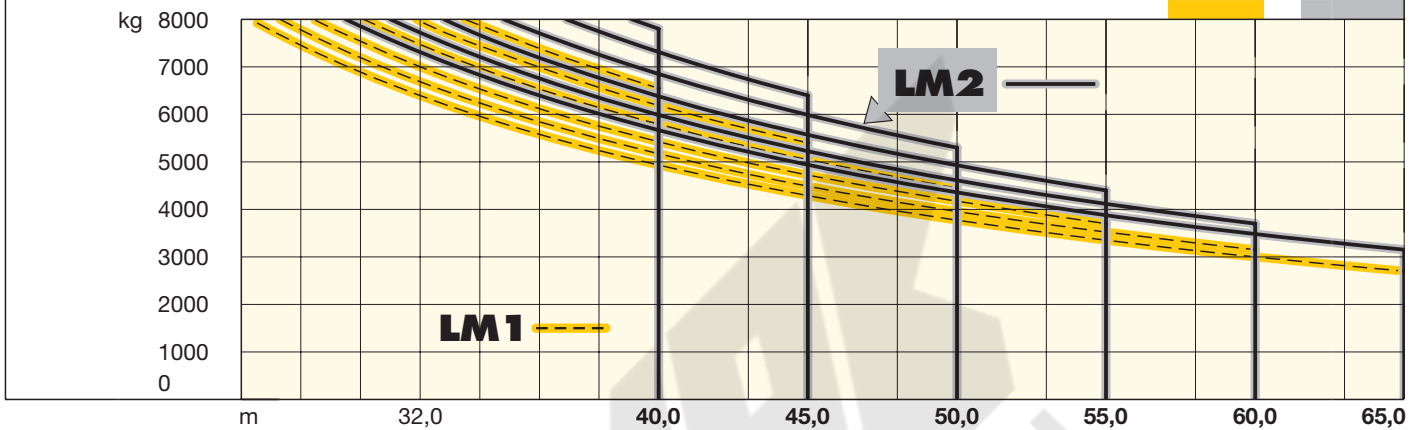











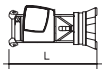

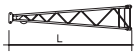



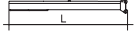

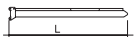





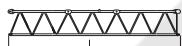















Antriebe

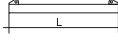

Driving units / Mécanismes d'entraînement / Azionamenti / Mecanismos / Mecanismos

	U/min 0 ↔ 0,7 sl./min tr./min	2 x 7,5 kW FR.tronic-FU
	0 ↔ 110,0 m/min	7,5 kW FR.tronic-FU
	25,0 m/min	4 x 7,5 kW (500 HC, 355 HC) 2 x 7,5 kW (256 HC)
	kVA	37 kW FU 45 kW FU 56,0 63,0

LM 2 Abweichende Geschwindigkeiten und Betriebsbedingungen. / Variant speeds and service conditions. / Vitesses et conditions de fonctionnement différentes. / Differenti velocità e condizioni di funzionamento. / Otras velocidades y características de funcionamiento. / Outras velocidades e características de funcionamento.

Montagegewichte: siehe Betriebsanleitung. / Erection weights: see instruction manual. / Poids de montage: voir manuel de service. / Pesos de montaje: vézase las instrucciones sull'uso. / Pesos de montagem: veja-se as instruções p. uso. / Peso para el montaje: según manual.

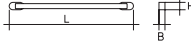
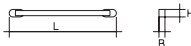
Kranoberteil		Upper part of crane / Partie supérieure de grue / Parte superiore della gru Parte superior grúa / Parte superior do guindaste	L (m)	B (m)	H (m)	kg*			
Pos. Item Ref	Anz. Qty. Qta. Cant. Cant.	Drehbühne / Slewing platform / Ensemble mât-cabine / Piattaforma girevole / Conjunto plataforma de giro / Plataforma giratória			5,40	2,74	2,64	9300	
1	1								
2	1	Turmspitze / Tower head / Porte-flèche / Cuspide / Cabeza de torre / Cabeça de apoio de lança			7,90	1,62	1,80	2500	
3	1	Hubwerkseinheit / Hoist gear unit / Treuil de levage / Gruppo meccanismo sollevamento / Mecanismo de elevación / Grupo de mecanismo elevatório			2,39	2,19	1,68	3270	
4	1	Gegenausleger-Kopfstück / Counter-jib head / Pointe de contre-flèche / Testa di controbraccio / Tramo punta de contrapluma / Cabeça de contra-lança			8,50	2,42	0,92	2850	
5	1	Gegenausleger-Anlenkstück / Counter-jib heel section / Pied de contre-flèche / Settore articolato di controbraccio / Tramo primero-contrapluma / Base articulada da contra-lança			8,44	1,77	0,92	2800	
6	1	Gegenausleger-Zwischenstück / Intermediate counter-jib section / Élément interm. de contre-flèche / Spezzione di controbraccio / Tramo intermedio de contrapluma / Peça suplementar da contra-lança			3,22	1,76	0,92	950	
7	1	Ausleger-Anlenkstück / Jib heel section / Pied de flèche / Settore articolato di braccio / Base articulada de lança / Pluma tramo primero			12,30	1,84	1,90	⊕ 2980	
8	1	Ausleger-Zwischenstück / Intermediate jib section / Élément intermédiaire de flèche / Spezzione di braccio / Peça suplementar da lança / Tramo intermedio pluma			10,40	1,63	1,85	⊕ 1680	
1	10,40				1,63	1,85	⊕ 1610		
1	12,30				1,63	1,85	⊕ 1840		
1	5,30				1,63	1,85	⊕ 585		
1	10,40				1,63	1,85	⊕ 1100		
1	5,30				1,63	1,85	⊕ 400		
9	1	Ausleger-Kopfstück / Jib head / Pointe de flèche / Punta freccia / Cabeça de lança / Tramo punta de pluma			1,70	1,84	2,05	⊕ 300	
10	1	Laufkatze und Lasthaken / Trolley and hook / Chariot de distribution et crochet / Carrello con gancio / Carrito y gancho / Carro de ponte e gancho			1,89	1,83	1,20	760	
Turm		Tower / Mât / Torre Torre / Torre							
11	9	Turmstück / Tower section / Élément de mât / Elemento di torre / Torre / Torre			256 HC	4,14	2,30	2,30	2300
11	355 HC				6,28	2,45	2,45	5050	
13	500 HC				6,28	2,45	2,45	6480	
12	1	Turmstück lang / Long tower section / Élément de mât long / Elemento di torre, lungo / Tramo de torre largo / Peça de torre, comprida			256 HC	12,42	2,30	2,30	5770
13	1	Grundturmstück / Base tower section / Mât de base / Elemento di torre base / Tramo torre base / Peça de base de torre			256 HC	8,85 (12,42)	2,30 (2,30)	2,30 (2,30)	4580 (7700)
Klettereinrichtung		Climbing equipment / Equipement de télescope / Attrezzatura per allungamento della gru Equipo de trepado / Acessórios p. subida no edificio							
14	1	Führungsstück kpl., geteilt / Guide section cpl., split / Cage télescopique cpl., divisée / Gabbia di sopraelevazione compl., suddivisa / Torre de montaje, dividida / Peça de guia, subdividida			256 HC	8,39	2,68	2,58 (3,04)	5100
	355 HC				12,39	2,75	1,58	8300	
	500 HC				12,39	2,75	1,58	8300	
15	1	Hydraulikanlage, Stütz- und Klettertraverse / Hydraulic unit, supporting and climbing cross members / Système hydraulique avec traverses d'appui et de télescope / Sistema hidráulico, travessa di appoggio e allungamento gru / Instalação hidráulica, travessa de apoio e subida / Sistema hidráulico con traviesa de apoyo y trepado			256 HC	2,10	1,25	1,00	1150
	355 HC				2,10	1,10	1,00	1810	
	500 HC				2,10	1,10	1,00	1810	
Unterwagen		Undercarriage / Châssis / Carro della gru Carro con mástil / Carro de guindaste							
16	4	Ausgleichsschwinge mit Schwingenlager / Pivot for wheel box / Chape pour bogie / Bilanciere di equilibratura con cuscinetto bilanciere / Balancin / Balancim com suporte			355 HC	1,60	0,72	1,48	1390
	500 HC								
17	2	Fahrschemel mit Antrieb / Rail bogie with drive / Bogie moteur / Telaio con gruppo propulsore / Quadro sem grupo de propulsão / Caja rodillo motriz			256 HC	1,63 (1,46)	0,92 (0,84)	0,95 (0,87)	1690 (920)
4	355 HC				1,40	0,75	0,65	920	
4	500 HC				1,45	0,82	0,72	1690	
18	2	Fahrschemel ohne Antrieb / Rail bogie without drive / Bogie fou / Telaio senza gruppo propulsore / Quadro con grupo de propulsão / Caja rodillo conducido			256 HC	1,37 (1,15)	0,62 (0,60)	0,95 (0,87)	1340 (880)
4	355 HC				1,10	0,60	0,65	880	
4	500 HC				1,30	0,40	0,72	1340	
19	1	Tragholm lang / Long support arm / Longeron long / Longherone lungo / Brazo largo soporte / Travessa comprida			256 HC	9,10 (11,95)	0,80 (0,82)	0,80 (0,80)	1650 (2200)
1	355 HC				11,82	0,92	0,93	3515	
2	500 HC				7,32	0,92	0,93	2330	
20	2	Tragholm kurz / Short support arm / Longeron court / Longherone corto / Brazo corto soporte / Travessa curta			256 HC	4,45 (5,58)	0,77 (0,65)	0,77 (0,77)	800 (1035)
	355 HC				5,74	0,80	0,90	1600	
	500 HC				7,14	0,80	0,90	2135	

Pos. Item Rep Voce Pos. Ref.	Anz. Qty. Qté. Qta. Cant. Cant.			L (m)	B (m)	H (m)	kg*	
21	2 + 2	Randträger / Border support Traverse / Supporti base Traviesa / Apoio de bordo		256 HC	5,46 – 5,40	0,11 – 0,18	0,16 – 0,38	175 – 525
					(7,52 – 7,46)	(0,1 – 0,17)	(0,1 – 0,38)	(366 – 912)
				355 HC	7,30	0,14	0,14	340
				500 HC	9,30	0,14	0,14	510
22	4	Stützholm / Support strut Hauban de châssis / Correnti di appoggio Tirante vertical / Travessa de apoio		256 HC	4,14 (6,55)	0,18 (0,22)	0,25 (0,25)	320 (600)
								862
				355 HC	6,06	0,26	0,34	1140
				500 HC	6,98	0,26	0,34	1140
23	1	Unterswagen-Turmstück / Undercarriage tower section / Mât de châssis / Elemento di torre del carro / Tramo de carro / Peça de torre do chassis		256 HC	3,73 (6,70)	2,62 (2,53)	2,62 (2,53)	2550 (3800)
								7475
				355 HC	6,61	2,44	2,44	7930
				500 HC	6,61	2,44	2,44	7930
24		Kleinteile, Seile und Abspannungen / Small parts, ropes and holding bars Accessoires, câbles et tirants / Accessori, funi e attrezzi di ancoraggio Despieces, cables y tirantes / Acessórios, cabos e peças de ancoragem		256 HC				
				355 HC	9,00	1,60	1,00	5000
				500 HC				

() **Angaben in Klammern gelten für 8 m-Unterswagen.** / The data in brackets are valid for an undercarriage of 8 m. / Les données techniques indiquées entre parenthèses sont valables pour un châssis de 8 m. / Caratteristiche in (..) valgono per carro di 8 m. / Los datos entre paréntesis son válidos para carro de 8 m. Características em (..) válidas pelo chassis de 8 m.

* **Einzelgewichte.** / Single weights. / Poids individuels. / Pesì di componenti. / Pesos de peças componentes. / Pesos unitarios.



Konstruktionsänderungen vorbehalten!

Subject to alterations! / Sous réserves de modifications!
Si fa riserva di modifiche! / Salvo modificação da construação!
¡Sujeto a modificaciones!

Sämtliche Angaben erfolgen ohne Gewähr. / This information is supplied without liability.

Ces renseignements sont sans garantie. / Le indicazioni contenute si intendono salvo errori ed omissioni.
Declinamos toda responsabilidad derivada de la información proporcionada. / Declinamos qualquer
responsabilidade quanto à informação fornecida.