

Turmdrehkran

Tower Crane / Grue à tour / Gru a torre
Grúa torre / Guindaste de torre

180 EC-H 10 FR.tronic®

180 EC-H 10 Litronic®

▶ 180 EC-H 10 FR.tronic®
▶ 180 EC-H 10 Litronic®

180 EC-H 12 FR.tronic®

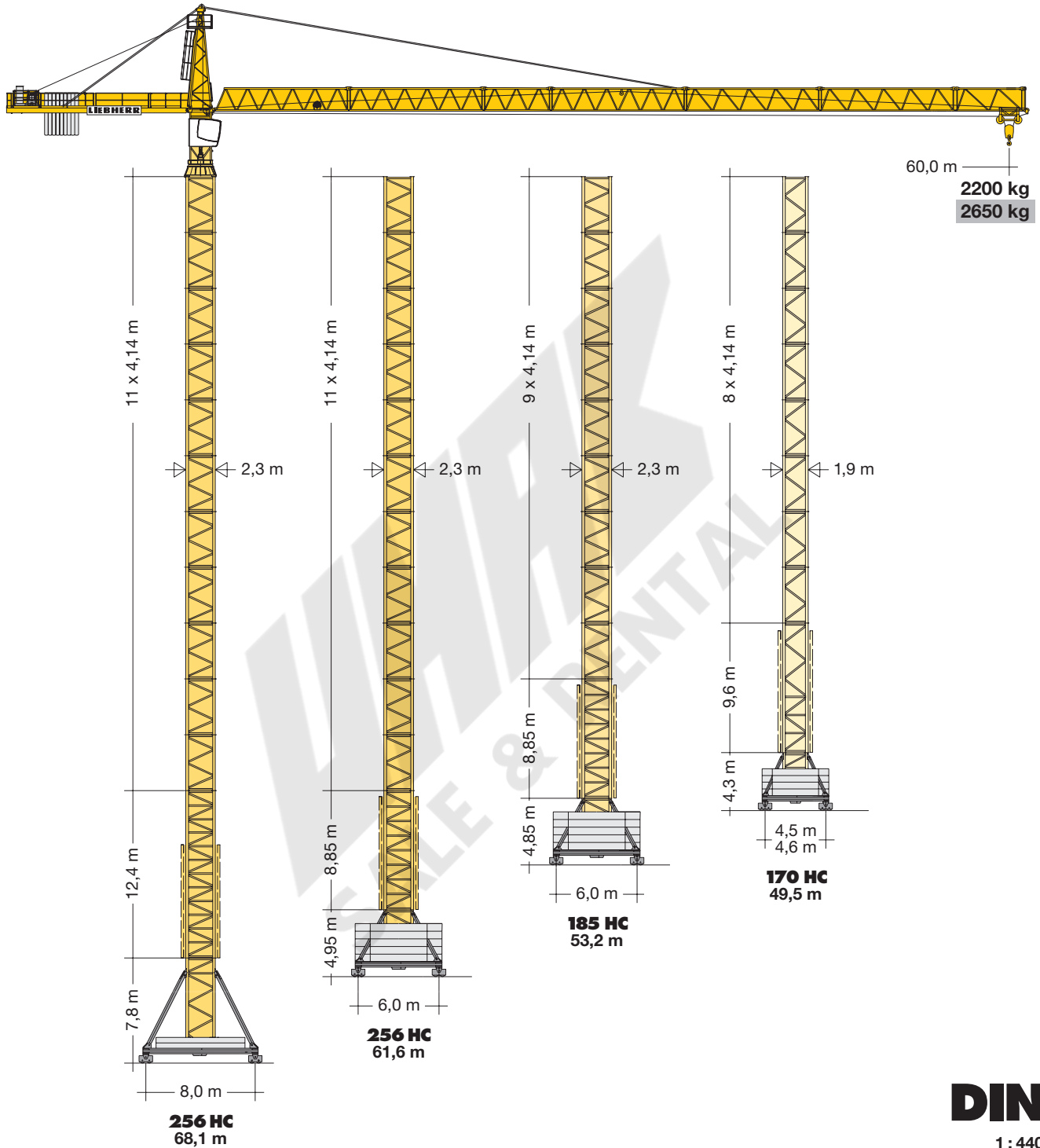

LIEBHERR

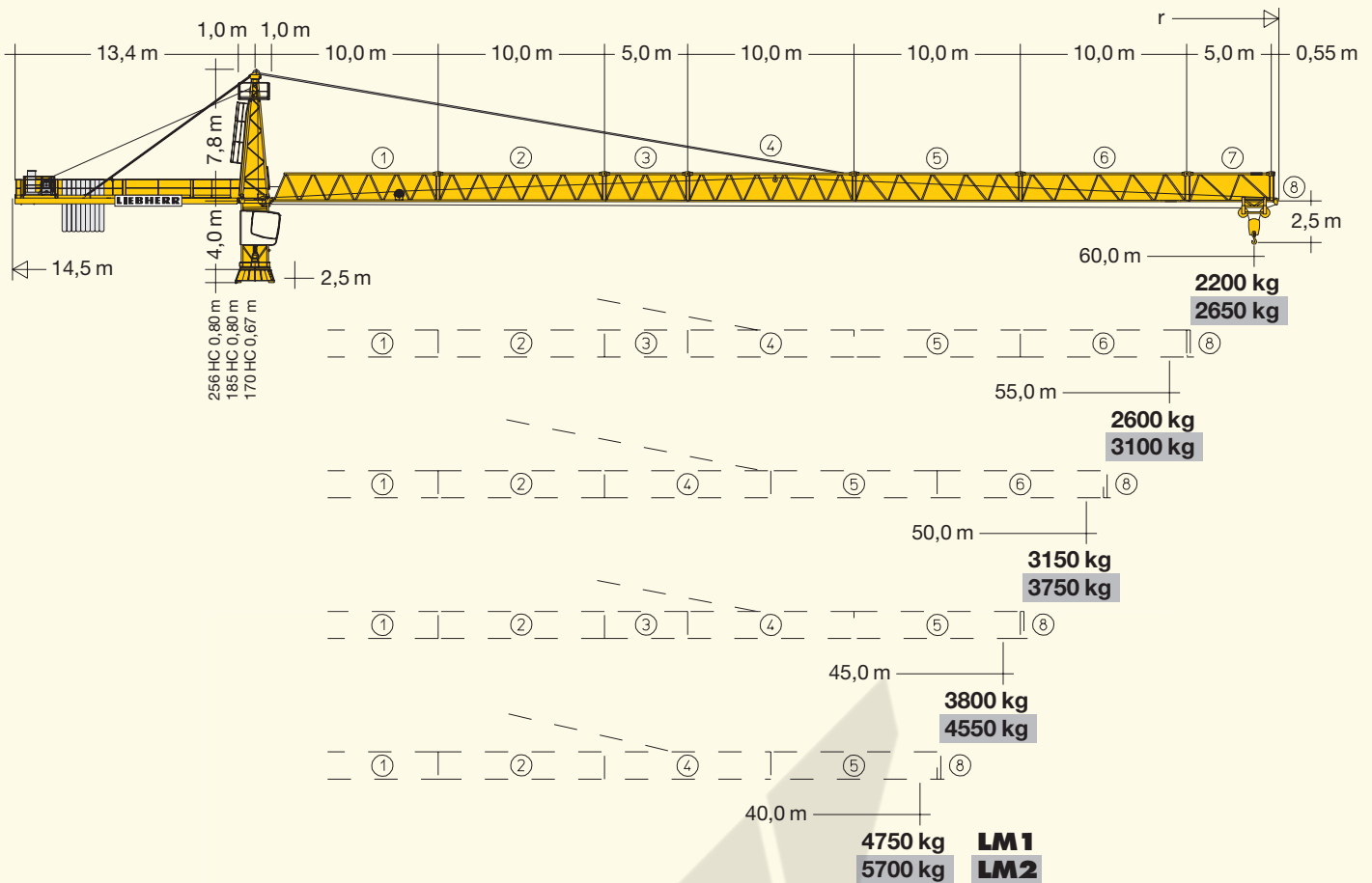

Hubhöhe

Hoisting height / Hauteur sous crochet / Altezza di sollevamento / Altura bajo gancho / Altura de montagem

	170 HC		185 HC			256 HC						
12	-	-	-	-	-	-	64,6*	-	-	-	-	-
11	-	-	-	-	-	56,9*	60,5*	61,6*	65,2*	-	-	68,1*
10	-	-	52,8*	-	-	52,8	56,3	57,5	61,1*	54,1*	57,7*	63,9
9	49,5**	-	48,6*	53,2*	50,0*	48,6	52,2	53,3	56,9	50,0	53,6	59,8
8	45,4*	49,5*	44,5	49,0	45,9	44,5	48,0	49,2	52,8	45,9	49,4	55,6
7	41,2	45,4	40,3	44,9	41,7	40,3	43,9	45,0	48,7	41,7	45,3	51,5
6	37,1	41,2	36,2	40,7	37,6	36,2	39,8	40,9	44,5	37,6	41,2	47,4
5	32,9	37,1	32,1	36,6	33,4	32,1	35,6	36,8	40,4	33,4	37,0	43,2
4	28,8	32,9	27,9	32,5	29,3	27,9	31,5	32,6	36,2	29,3	32,9	39,1
3	24,7	28,8	23,8	28,3	25,2	23,8	27,3	28,5	32,1	25,2	28,7	34,9
2	20,5	24,7	19,6	24,2	21,0	19,6	23,2	24,3	28,0	21,0	24,6	30,8
1	16,4	20,5	15,5	20,0	16,9	15,3	19,1	20,2	23,8	16,9	20,5	26,7
0	12,2	16,4	11,4	15,9	12,7	11,4	14,9	16,1	19,7	12,7	16,3	22,5
	m		m			m a)	b)	a)	b)	a)	b)	

--	--	--	--

* **xx LM 2 Nicht möglich.** / Not possible. / Pas possible. / Non possibile. / No posible. / Nao é possível.
Weitere Hubhöhen, Auslegerlängen sowie Klettern im Gebäude auf Anfrage. / Further hoist heights and jib lengths as well as climbing inside the building on request. / Autres hauteurs sous crochet et longueurs de flèche ainsi que hissage dans le bâtiment sur demande. / Ulteriori altezze gancho, lunghezze braccio così come telescopaggio all'interno dell'edificio: su richiesta. / Para alturas bajo gancho superiores, otros alcances y trepado en el interior del edificio, consultar. / Outras alturas de elevação, comprimentos de lança e subida no edifício: sob consulta.

Ausladung und Tragfähigkeit

Radius and capacity / Portée et charge / Sbraccio e portata / Alcances y cargas / Alcance e capacidade de carga

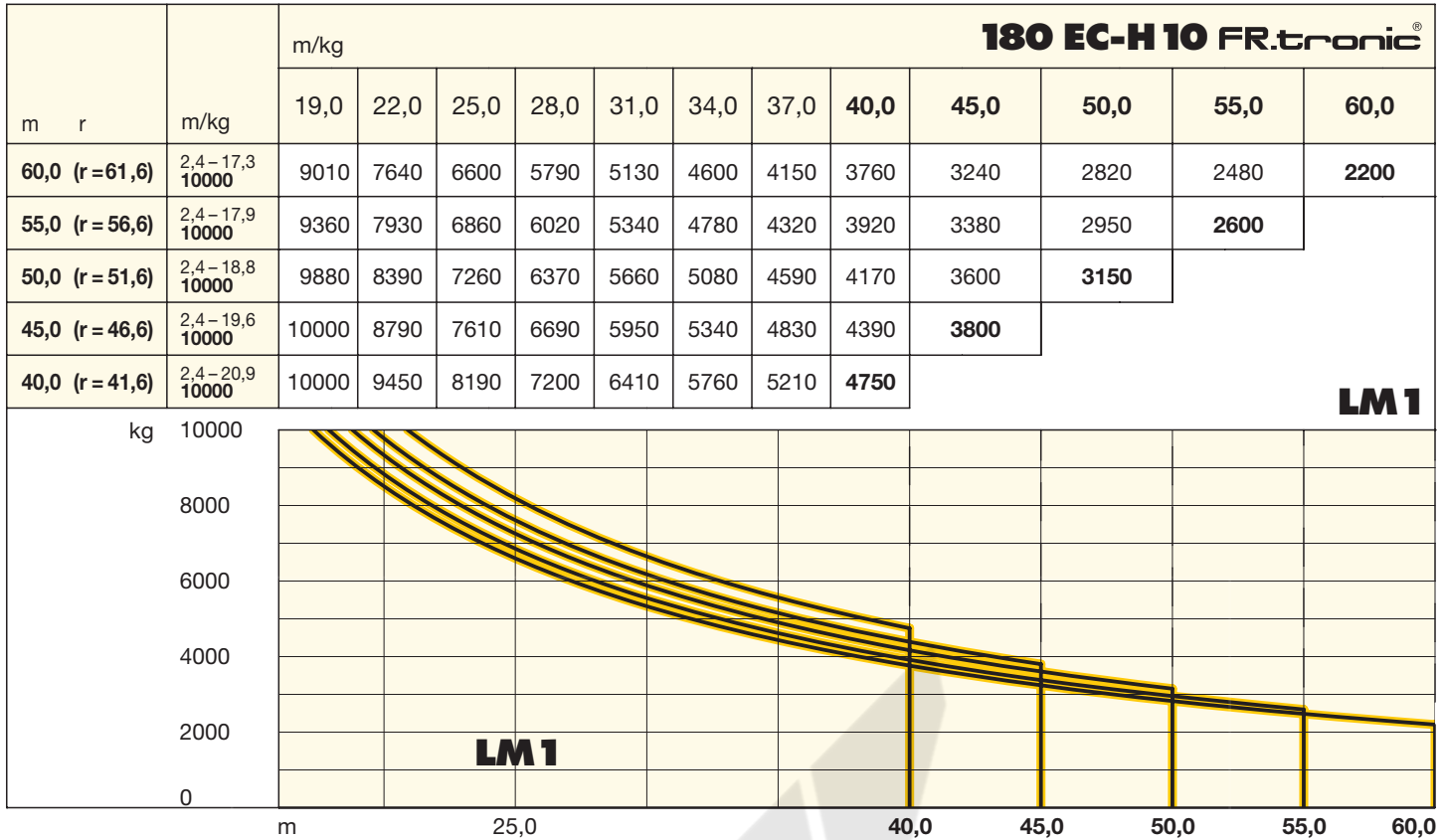

LM 1

Antriebe FR.tronic®/Litronic®

Driving units / Mécanismes d'entraînement / Azionamenti / Mecanismos / Mecanismos

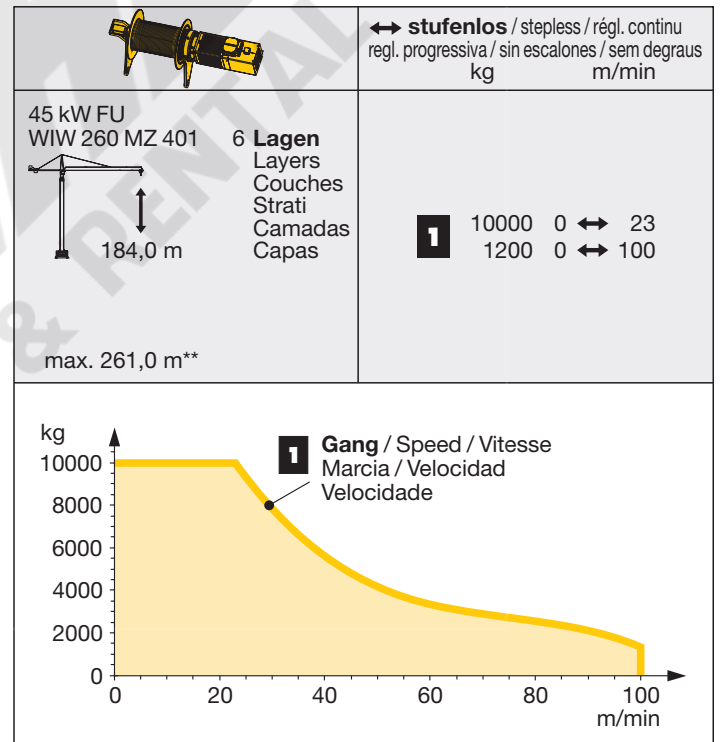
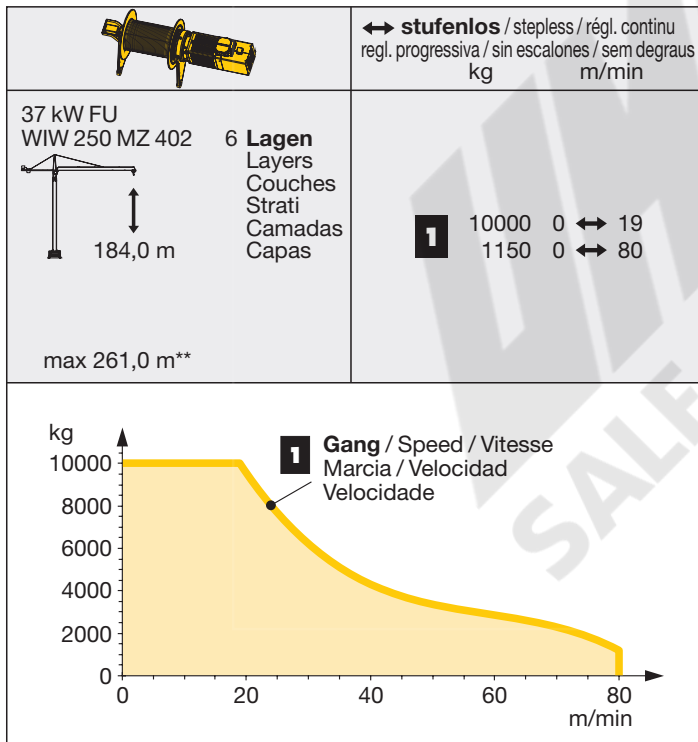

** Weitere Hublastdaten: siehe Betriebsanleitung. / Further hoist data: see instruction manual. / Autres données de la charge de levage: voir manuel d'instruction. / Altri dati sui carichi sollevati: consultare il manuale d'istruzione. / Alturas bajo grancho superiores según manual. / Outras tabelas de carga: consultar manual de instruções.

Ausladung und Tragfähigkeit

Radius and capacity / Portée et charge / Sbraccio e portata / Alcances y cargas / Alcance e capacidade de carga

m	r	m/kg	180 EC-H 10 Litronic®											
			19,0	22,0	25,0	28,0	31,0	34,0	37,0	40,0	45,0	50,0	55,0	60,0
60,0	(r=61,6)	2,4-17,3 10000	9010	7640	6600	6500	6010	5390	4880	4440	3840	3370	2980	2650
55,0	(r=56,6)	2,4-20,4 10000	10000	9200	7970	7010	6230	5600	5060	4610	4000	3500	3100	
50,0	(r=51,6)	2,4-18,8 10000	9880	8390	8300	7450	6630	5960	5400	4920	4270	3750		
45,0	(r=46,6)	2,4-22,7 10000	10000	10000	8970	7900	7040	6330	5740	5240	4550			
40,0	(r=41,6)	2,4-24,4 10000	10000	10000	9720	8570	7640	6880	6240	5700				

LM1 + LM2

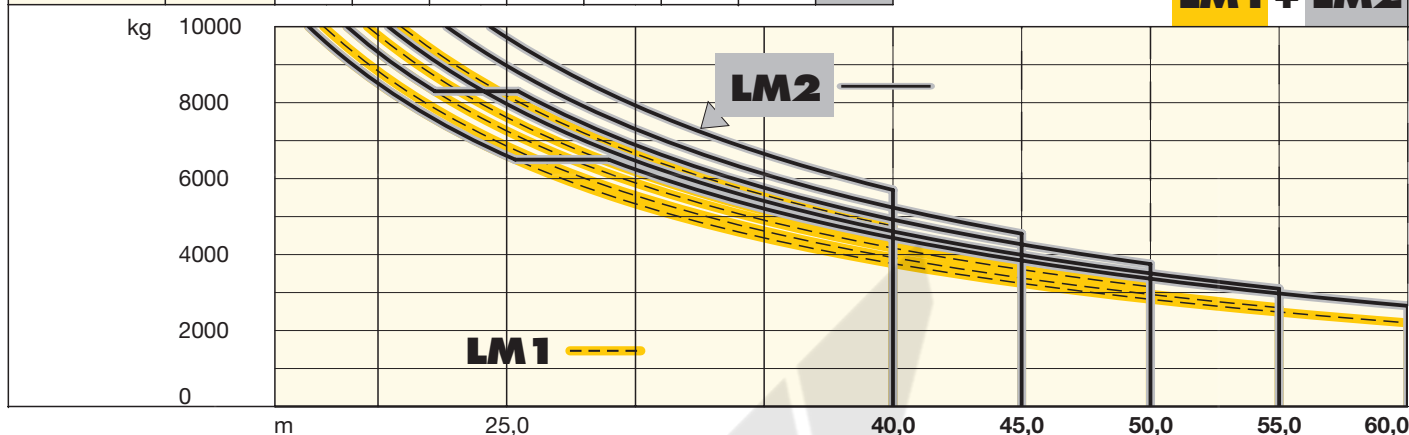

Antriebe FR.tronic®/Litronic®

Driving units / Mécanismes d'entraînement / Azionamenti / Mecanismos / Mecanismos

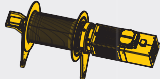

65 kW FU
WIW 280 MZ 405 6 **Lagen**
Layers
Couches
Strati
Camadas
Capas





184,0 m

max. 344,0 m**

↔ **stufenlos** / stepless / régl. continu
régl. progressive / sin escalones / sem degraus
kg m/min

I 10000 0 ↔ 33
2200 0 ↔ 110











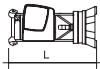

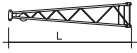







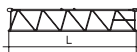

















I **Gang** / Speed / Vitesse
Marcia / Velocidad
Velocidade

	U/min 0 ↔ 0,8 sl./min tr./min	2 x 7,5 kW FU
	0 ↔ 100,0 m/min	5,5 kW FU
	25,0 m/min	2 x 5,5 kW (170 HC, 185 HC) 2 x 7,5 kW (256 HC)
	kVA	37 kW FU 45 kW FU 65 kW FU 54,0 61,0 84,0

LM 2 Abweichende Geschwindigkeiten und Betriebsbedingungen.
Variant speeds and service conditions. / Vitesses et conditions de fonctionnement différentes. / Differenti velocità e condizioni di funzionamento. / Otras velocidades y características de funcionamiento. / Outras velocidades e características de funcionamento.

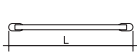
Litronic: kVA reduzierbar bei zu geringer Netz-Anschlussleistung, siehe BAL. / kVA can be reduced in case of too little power of the mains, see instruction manual. / kVA peut être réduit en cas de trop faible puissance du réseau, voir manuel d'instruction. / kVA riducibili in caso di potenza di rete ridotta (si veda manuale uso e manutenzione) / kVA variable para potencia de red demasiado pequeña, ver Manual de instrucciones. / kVA reduzível no caso de capacidade da rede elétrica muito baixa, ver manual de instruções.

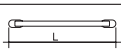
Montagegewichte: siehe Betriebsanleitung. / Erection weights: see instruction manual. / Poids de montage: voir manuel de service.
Pesi di montaggio: vedasi le istruzioni sull'uso. / Peso para el montaje: según manual. / Pesos de montagem: veja-se as instruções p. uso.

Kranoberteil		Upper part of crane / Partie supérieure de grue / Parte superiore della gru							
Pos. Item Ref	Anz. Qty. Qta. Voce Cant. Cant.				L (m)	B (m)	H (m)		kg*
1	1	Drehbühne kpl. / Slewing platform cpl. Ensemble mât cabine cpl. / Piattaforma girevole compl. / Conjunto plataforma de giro Plataforma giratória compl.			170 HC	5,24	2,45	2,63	7900
					185 HC	5,40	2,80	2,64	8400
					256 HC	5,40	2,80	2,64	8400
2	1	Turmspitze / Tower head section Porte-flèche / Testa porta-braccio Cabeça de apoio de lança			7,90	1,48	1,91	1900	
3	1	Gegenausleger / Counter-jib Contre-flèche / Controbraccio Contrapluma / Contra-lança			13,50	2,30	0,61	3500	
4	1	Hubwerkseinheit / Hoist gear unit / Treuil de levage / Gruppo meccanismo sollevamento / Mecanismo de elevación Grupo de mecanismo elevatório			2,20	2,34	1,70	2700	
5	1	Ausleger-Anlenkstück / Jib heel section Pied de flèche / Settore articolato di braccio Pluma tramo primero / Base articulada de lança			10,21	1,68	1,95	① 2010	
6	4	Ausleger-Zwischenstück / Intermediate jib section / Elément intermédiaire de flèche / Spezzone di braccio / Tramo intermedio pluma / Peça suplementar da lança			10,30	1,50	1,95	② 1320 ④ 1400 ⑤ 1100 ⑥ 710	
7	2	Ausleger-Zwischenstück / Intermediate jib section / Elément intermédiaire de flèche / Spezzone di braccio / Tramo intermedio pluma / Peça suplementar da lança			5,30	1,50	1,90	③ 710 ⑦ 350	
8	1	Ausleger-Kopfstück / Jib head section Pointe de flèche / Punta freccia Tramo punta de pluma / Cabeça de lança			0,65	1,66	2,00	⑧ 170	
9	1	Laufkatze und Lasthaken / Trolley and hook / Chariot de distribution et crochet / Carrello con gancio / Carrito y gancho / Carro de ponte e gancho			1,85	1,69	1,42	950	
Turm		Tower / Mât / Torre							
10	8- 9 9- 10 10- 12	Turmstück / Tower section Elément de mât / Elemento di torre Tramo torre / Torre			170 HC 4,14 185 HC 4,14 256 HC 4,14	1,90 2,30 2,30	1,90 2,30 2,30	1850 2240 2300	
11	1	Turmstück lang / Long tower section Elément de mât long / Elemento di torre, lungo Tramo de torre largo / Peça de torre, comprida			170 HC 12,42 185 HC 12,42 256 HC 12,42	1,90 2,30 2,30	1,90 2,30 2,30	4780 5460 5770	
12	1	Grundturmstück / Base tower section Mât de base / Elemento di torre base Tramo base / Peça de base de torre			170 HC 9,60 185 HC 8,85 256 HC 8,85 (12,42)	1,90 2,30 2,30 (2,30)	1,90 2,30 2,30 (2,30)	4480 4280 4830 (7940)	
Klettereinrichtung		Climbing equipment / Equipement de télescopage / Attrezzatura per allungamento della gru							
		Equipo de trepado / Acesórios p. subida no edificio							
13	1	Führungsstück kpl. / Guide section cpl. / Cage télescopique cpl. / Gabbia di sopraelevazione compl. / Torre de montaje completa / Peça de guia compl.			170 HC 9,04 185 HC 8,39 256 HC 8,39	2,31 2,68 2,68	2,28 2,58 (3,04) 2,58 (3,04)	4400 5210 5210	
14	1	Hydraulikanlage, Stütz- und Klettertraverse / Hydraulic unit, supporting and climbing cross members / Système hydraulique avec traverses d'appui et de télescopage Sistema idraulico, travessa di appoggio e allungamento gru / Sistema hidráulico con travessa de apoio y trepado / Instalação hidráulica, travessa de apoio e subida			170 HC 2,00 185 HC 2,30 256 HC 2,30	1,10 1,25 1,25	1,00 1,00 1,00	1100 1150 1300	
Unterwagen		Undercarriage / Châssis / Carro della gru							
		Carro con mástil / Carro de guindaste							
15	2	Fahrschemel mit Antrieb / Rail bogie with drive / Bogie moteur / Telaio con gruppo propulsore / Caja rodillo motriz / Quadro sem grupo de propulsão			170 HC 1,46 185 HC 1,46 256 HC 1,63 (1,46)	0,84 0,84 0,92 (0,84)	0,87 0,87 0,95 (0,87)	920 920 1690 (920)	
16	2	Fahrschemel ohne Antrieb / Rail bogie without drive / Bogie fou / Telaio senza gruppo propulsore / Caja rodillo conducido Quadro com grupo de propulsão			170 HC 1,15 185 HC 1,15 256 HC 1,37 (1,15)	0,60 0,60 0,62 (0,60)	0,87 0,87 0,95 (0,87)	880 880 1340 (880)	
17	1	Tragholm lang / Long support arm Longeron long / Longherone lungo Brazo soporte largo / Travessa comprida			170 HC 7,15 185 HC 9,10 256 HC 9,10 (11,95)	0,80 0,82 0,80 (0,82)	0,70 0,74 0,80 (0,80)	1070 1350 1650 (2200)	
18	2	Tragholm kurz / Short support arm Longeron court / Longherone corto Brazo soporte corto / Travessa curta			170 HC 3,45 185 HC 4,41 256 HC 4,45 (5,58)	0,60 0,62 0,77 (0,65)	0,70 0,71 0,77 (0,77)	500 615 850 (1035)	
19	2 + 2	Randträger / Border support Traverse / Supporti base Traviesa / Apoio de bordo			170 HC 4,08 - 4,30 185 HC 5,48 - 5,46 256 HC 5,46 - 5,40 (7,52 - 7,46)	0,16 - 0,33 0,11 - 0,17 0,11 - 0,18 (0,10 - 0,17)	0,11 - 0,14 0,16 - 0,38 0,16 - 0,38 (0,10 - 0,38)	80 - 200 60 - 230 95 - 270 (183 - 460)	
20	4	Stützholm / Support strut Hauban de châssis / Correnti di appoggio Tirante vertical / Travessa de apoio			170 HC 3,53 185 HC 4,23 256 HC 4,14 (6,55)	0,25 0,17 0,18 (0,22)	0,17 0,25 0,25 (0,25)	240 275 330 (600)	

Pos. Item Rep. Voce Pos. Ref.	Anz. Qty. Qté. Qta. Cant. Cant.				L (m)	B (m)	H (m)	kg*
21	1	Unterswagen-Turmstück / Undercarriage tower section / Mât de châssis / Elemento di torre del carro / Tramo de carro / Peça de torre do chassis		170 HC 185 HC 256 HC	3,30 3,73 3,73 (6,70)	2,15 2,52 2,62 (2,53)	2,15 2,52 2,62 (2,53)	2000 2050 3000 (4200)
22	1	Kleinteile, Seile und Abspannungen / Small parts, ropes and holding bars / Accessoires, câbles et tirants / Accessori, funi e attrezzi di ancoraggio / Despieces, cables y tirantes / Acessórios, cabos e peças de ancoragem		170 HC 185 HC 256 HC	9,00	1,60	1,00	4000

() **Angaben in Klammern gelten für 8 m-Unterswagen.** / The data in brackets are valid for an undercarriage of 8 m. / Les données techniques indiquées entre parenthèses sont valables pour un châssis de 8 m. / Caratteristiche in (..) valgono per carro di 8 m. / Los datos entre paréntesis son válidos para carro de 8 m. / Características em (..) válidas pelo chassis de 8 m.

* **Einzelgewichte.** / Single weights. / Poids individuels. / Pesì di componenti. / Pesos unitarios. / Pesos de peças componentes.

WMAK
 SALE & RENTAL

Konstruktionsänderungen vorbehalten!
 Subject to alterations! / Sous réserves de modifications!
 Si fa riserva di modifiche! / ¡Sujeto a modificaciones!
 Salvo modificação da construçao!

Sämtliche Angaben erfolgen ohne Gewähr. / This information is supplied without liability.
 Ces renseignements sont sans garantie. / Le indicazioni contenute si intendono salvo errori ed omissioni.
 Declinamos toda responsabilidad derivada de la información proporcionada. / Declinamos qualquer
 responsabilidade quanto à informação fornecida.

121 P – 3903 H1 B3 DIN 15018 • BGL C.0.10.0180 • 04.07 / 6

Printed in Germany.