

Turmdrehkran

Tower Crane / Grue à tour / Gru a torre
Grúa torre / Guindaste de torre

110 EC-B 6 FR.tronic®

110 EC-B 6

▶ **110 EC-B 6 FR.tronic®**

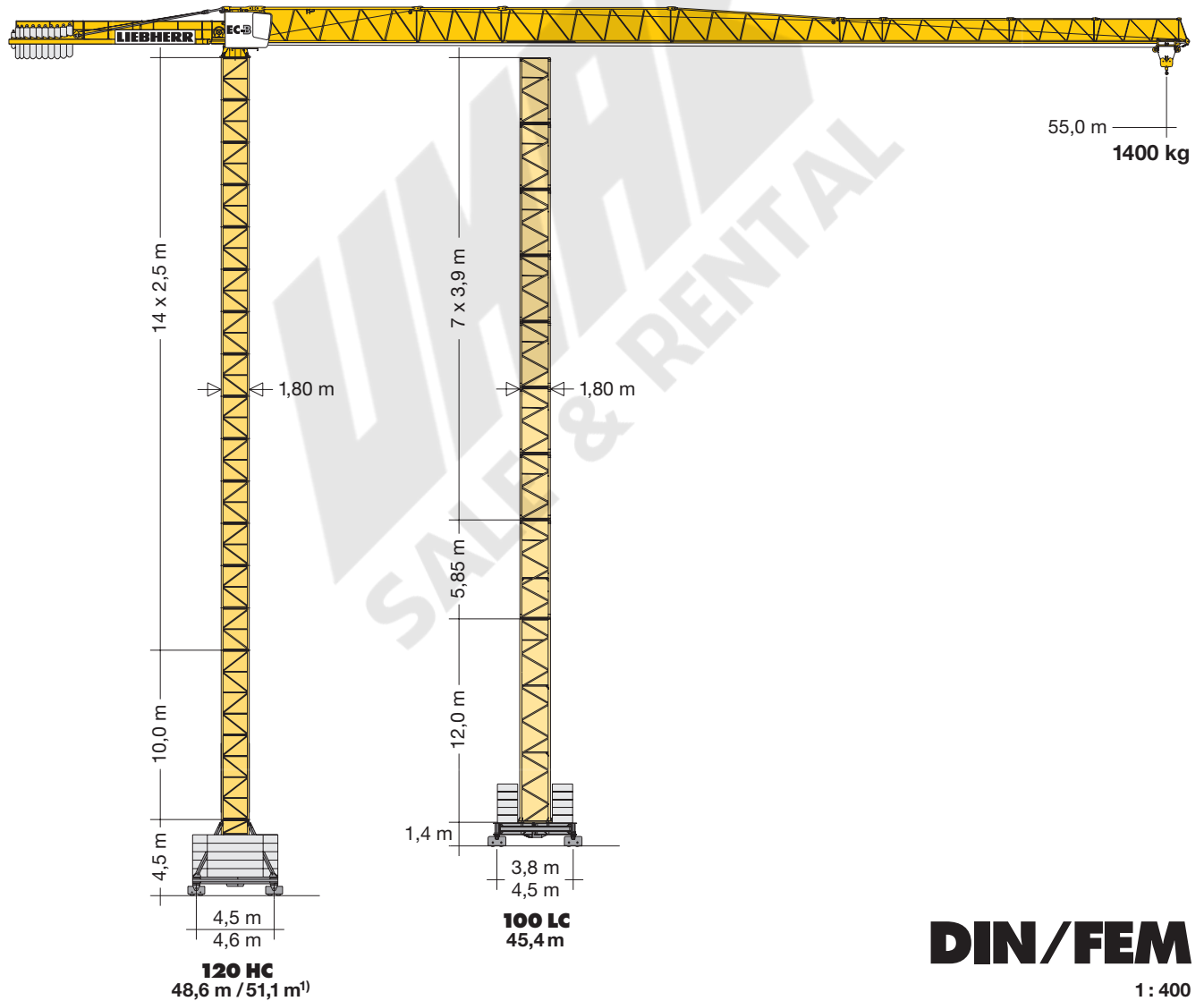

LIEBHERR

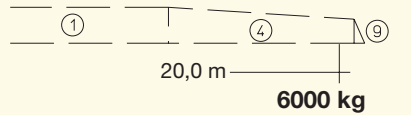
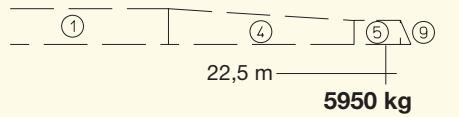
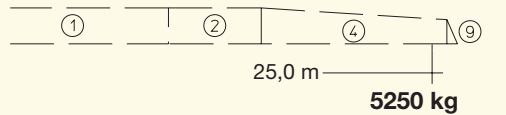
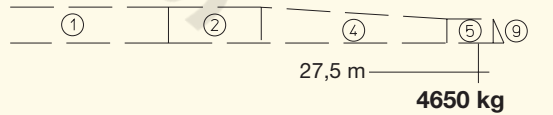
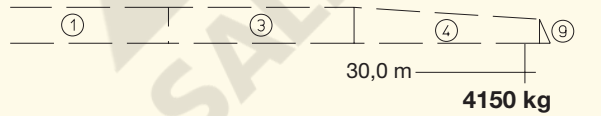
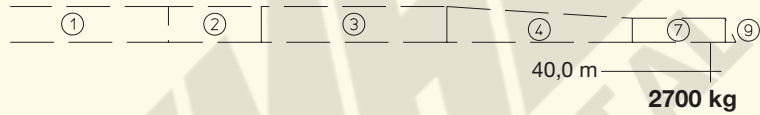
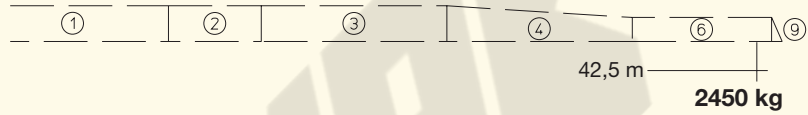
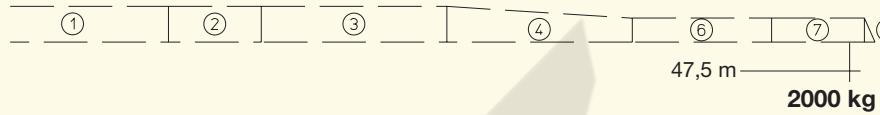
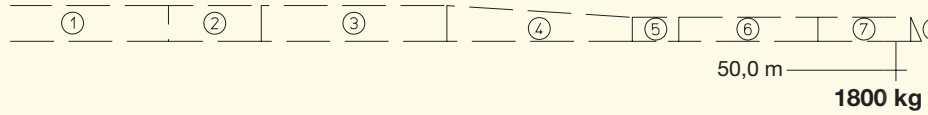
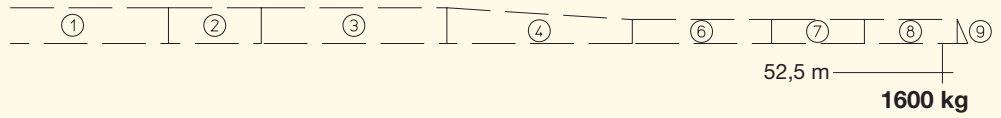
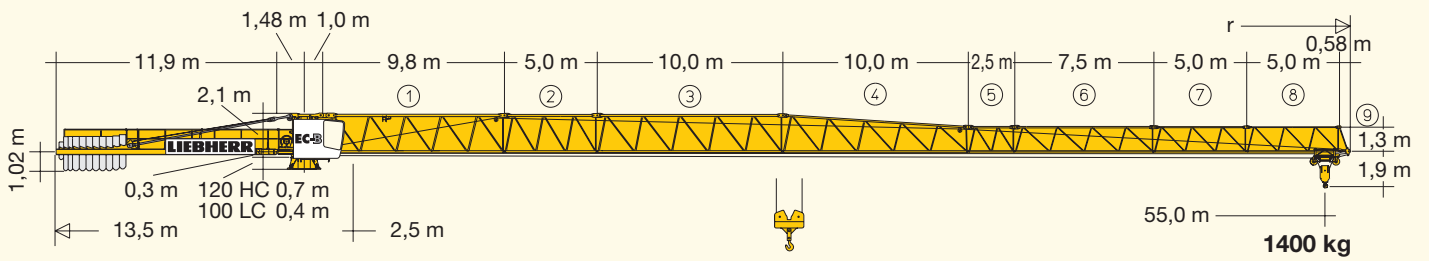

		110 EC-B 6 FR.tronic®																
m	r	m/kg	m/kg															
			17,5	20,0	22,5	25,0	27,5	30,0	32,5	35,0	37,5	40,0	42,5	45,0	47,5	50,0	52,5	55,0
55,0	(r = 56,5)	2,5-17,0 6000	5800	5000	4370	3870	3460	3120	2830	2580	2360	2170	2010	1860	1730	1610	1500	1400
52,5	(r = 54,0)	2,5-17,8 6000	6000	5270	4610	4080	3650	3290	2990	2730	2500	2310	2130	1980	1840	1710	1600	
50,0	(r = 51,5)	2,5-18,4 6000	6000	5480	4800	4260	3810	3440	3120	2850	2620	2420	2230	2070	1930	1800		
47,5	(r = 49,0)	2,5-18,9 6000	6000	5650	4950	4390	3930	3550	3230	2950	2710	2500	2310	2150	2000			
45,0	(r = 46,5)	2,5-19,3 6000	6000	5770	5050	4480	4020	3630	3300	3020	2770	2560	2370	2200				
42,5	(r = 44,0)	2,5-19,8 6000	6000	5940	5210	4620	4140	3740	3410	3120	2860	2640	2450					
40,0	(r = 41,5)	2,5-20,2 6000	6000	6000	5310	4710	4230	3820	3470	3180	2920	2700						
37,5	(r = 39,0)	2,5-20,6 6000	6000	6000	5440	4830	4330	3910	3560	3260	3000							
35,0	(r = 36,5)	2,5-21,1 6000	6000	6000	5570	4950	4440	4020	3660	3350								
32,5	(r = 34,0)	2,5-21,3 6000	6000	6000	5630	5010	4490	4060	3700									
30,0	(r = 31,5)	2,5-21,7 6000	6000	6000	5750	5110	4590	4150										
27,5	(r = 29,0)	2,5-21,9 6000	6000	6000	5830	5180	4650											
25,0	(r = 26,5)	2,5-22,2 6000	6000	6000	5910	5250												
22,5	(r = 24,0)	2,5-22,3 6000	6000	6000	5950													
20,0	(r = 21,5)	2,5-20,0 6000	6000	6000														

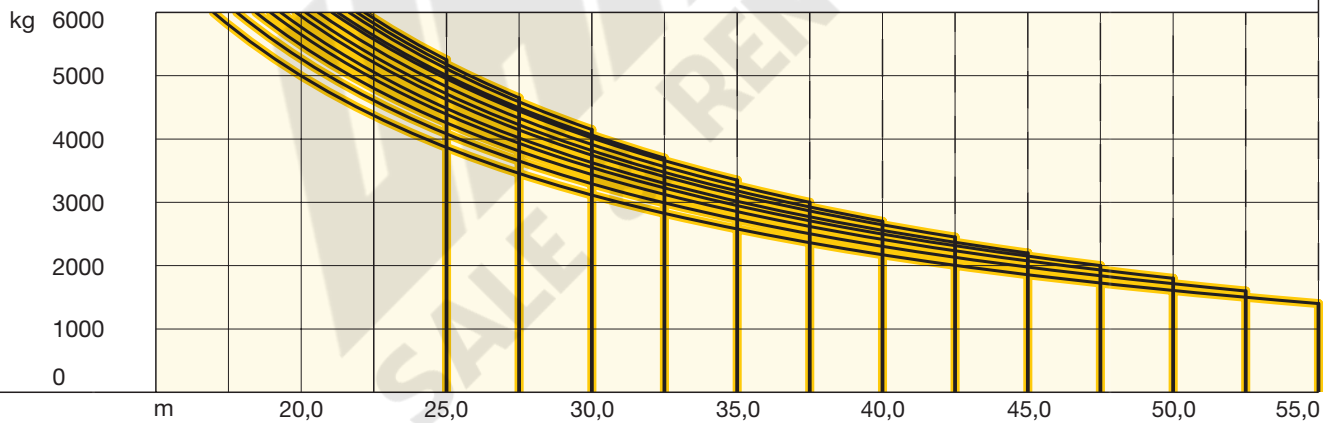

				100 LC											
3,9m	3,9m + 5,85m	5,85m	11,7m												
10	9+1	7		-	-	41,8 ^o	-	41,9 ^o	-	41,2 ^o	-	40,0 ^o	-		
	8+1			-	-	39,8	-	39,9	-	39,2	-	38,1	-		
9		6	3	-	-	37,9	49,5 ^o	38,0	49,6 ^o	37,3	48,9 ^o	36,1	48,1 ^o		
	7+1			-	-	35,9	47,5	36,0	47,6	35,3	46,9	34,2	46,1		
8				33,8	45,4	34,0	45,6	34,1	45,7	33,4	45,0	32,2	44,2		
	6+1	5		31,8	43,4	32,0	43,6	32,1	43,7	31,4	43,0	30,3	42,2		
7				29,9	41,5	30,1	41,7	30,2	41,8	29,5	41,1	28,3	40,3		
	5+1			27,9	39,5	28,1	39,7	28,2	39,8	27,5	39,1	26,4	38,3		
6				26,0	37,6	26,2	37,8	26,3	37,9	25,6	37,2	24,4	36,4		
	4+1	4	2	24,0	35,6	24,2	35,8	24,3	35,9	23,6	35,2	22,5	34,4		
5				22,1	33,7	22,3	33,9	22,4	34,0	21,7	33,3	20,5	32,5		
	3+1			20,1	31,7	20,3	31,9	20,4	32,0	19,7	31,3	18,6	30,5		
4				18,2	29,8	18,4	30,0	18,5	30,1	17,8	29,4	16,6	28,6		
	2+1			16,2	27,8	16,4	28,0	16,5	28,1	15,8	27,4	14,7	26,6		
3				14,3	25,9	14,5	26,1	14,6	26,2	13,9	25,5	12,7	24,7		
	1+1	2	1	12,3	23,9	12,5	24,1	12,6	24,2	11,9	23,5	10,8	22,7		
2				10,4	22,0	10,6	22,2	10,7	22,3	10,0	21,6	8,8	20,8		
	0+1			8,4	20,0	8,6	20,2	8,7	20,3	8,0	19,6	6,9	18,8		
1				6,5	18,1	6,7	18,3	6,8	18,4	6,1	17,7	4,9	16,9		
0	0	0	0	4,5	16,1	4,7	16,3	4,8	16,4	4,1	16,7	3,0	14,9		
				-	12,2	-	12,4	-	12,5	-	11,8	-	11,0		

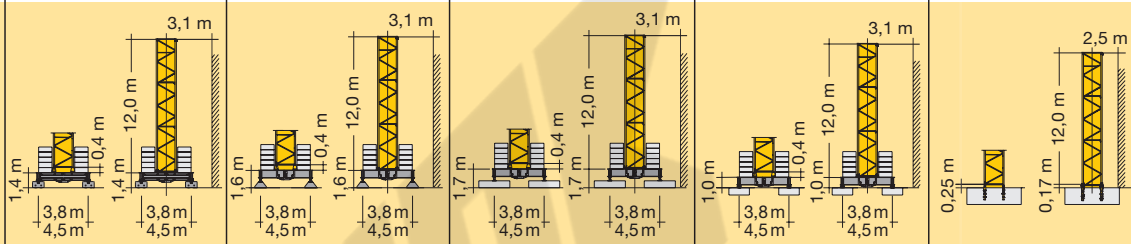



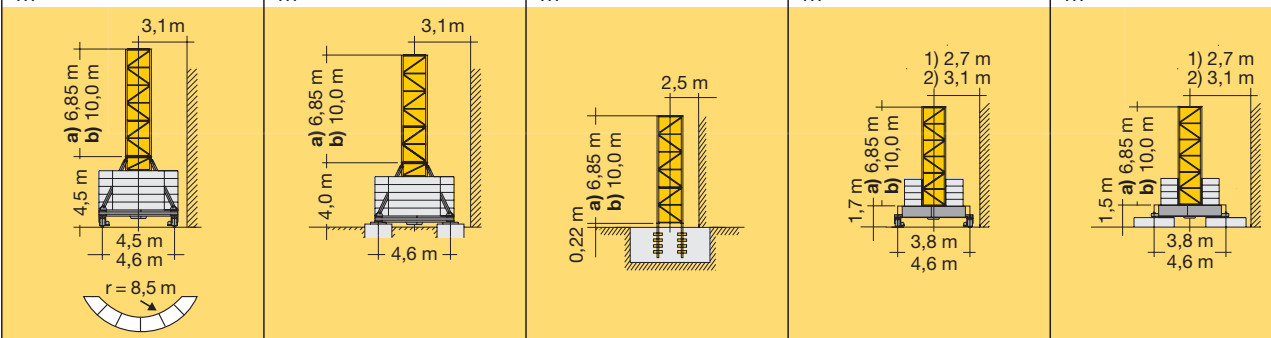

o = Ohne Kabine. / Without cabin. / Sans cabine. / Senza cabina. / Sin cabina. / Sem cabine.

Weitere Hubhöhen sowie Klettern auf Anfrage. / Further hoist heights and climbing on request. / Hauteurs sous crochet plus élevées et hissage sur demande. / Altre altezze di sollevamento come pure telescopaggio, su richiesta. / Para alturas bajo gancho superiores y trepado, consultar. / Outras alturas de elevação e ascensionamento, mediante consulta.

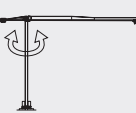
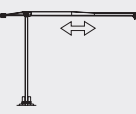
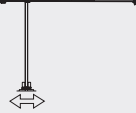
120 HC										
16	-	-	-	-	46,2 ¹⁾	-	-	-	-	-
15	48,0 ²⁾³⁾	51,1 ¹⁾	47,5 ²⁾³⁾	50,6 ¹⁾	43,7 ²⁾³⁾	46,8 ²⁾³⁾	45,2 ²⁾³⁾	48,3 ²⁾³⁾	45,0 ²⁾³⁾	48,1 ²⁾³⁾
14	45,5 ⁴⁾	48,6 ²⁾³⁾	45,0 ⁴⁾	48,1 ²⁾³⁾	41,2 ⁴⁾	44,3 ⁴⁾	42,7 ⁴⁾	45,8 ⁴⁾	42,5 ⁴⁾	45,6 ⁴⁾
13	43,0	46,1 ⁴⁾	42,5	45,6 ⁴⁾	38,7	41,8	40,2	43,3	40,0	43,1
12	40,5	43,6	40,0	43,1	36,2	39,3	37,7	40,8	37,5	40,6
11	38,0	41,1	37,5	40,6	33,7	36,8	35,2	38,3	35,0	38,1
10	35,5	38,6	35,0	38,1	31,2	34,3	32,7	35,8	32,5	35,6
9	33,0	36,1	32,5	35,6	28,7	31,8	30,2	33,3	30,0	33,1
8	30,5	33,6	30,0	33,1	26,2	29,3	27,7	30,8	27,5	30,6
7	28,0	31,1	27,5	30,6	23,7	26,8	25,2	28,3	25,0	28,1
6	25,5	28,6	25,0	28,1	21,2	24,3	22,7	25,8	22,5	25,6
5	23,0	26,1	22,5	25,6	18,7	21,8	20,2	23,3	20,0	23,1
4	20,5	23,6	20,0	23,1	16,2	19,3	17,7	20,8	17,5	20,6
3	18,0	21,1	17,5	20,6	13,7	16,8	15,2	18,3	15,0	18,1
2	15,5	18,6	15,0	18,1	11,2	14,3	12,7	15,8	12,5	15,6
1	13,0	16,1	12,5	15,6	8,7	11,8	10,2	13,3	10,0	13,1
0	a) 10,5	b) 13,6	a) 10,0	b) 13,1	a) 6,2	b) 9,3	a) 7,7	b) 10,8	a) 7,5	b) 10,6



	U/min 0 ↔ 0,8 sl./min tr./min	7,5 kW FU
	0 ↔ 63,0 m/min 0 ↔ 80,0 m/min	3,0 kW FU 5,4 kW FU
	25,0 m/min	2 x 4,0 kW
	kVA	30,0 kW FU 33,0

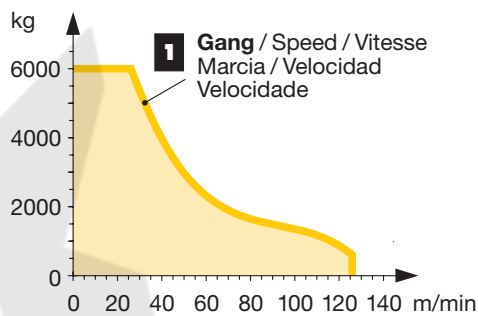































	↔ stufenlos / stepless / régl. continu regl. progressiva / sin escalones / sem degraus kg m/min
30 kW FU WIW 240 MZ 403	
	5 Lagen Layers Couches Strati Camadas Capas
100,0 m	1 6000 0 ↔ 26 550 0 ↔ 126
174,0 m**	
 <p>1 Gang / Speed / Vitesse Marcia / Velocidad Velocidade</p>	

** Weitere Hublastdaten: siehe Betriebsanleitung. / Further hoist load data: see instruction manual. / Autres données de la charge de levage: voir manuel d'instruction. / Altri dati sui carichi sollevati: consultare il manuale d'istruzione. / Alturas bajo grancho superiores según manual. / Outras tabelas de carga: consultar manual de instruções.

Kolli-Liste

Packing List / Liste de colisage / Lista dei colli / Lista de contenido / Lista de embalagem

Montagegewichte: siehe Betriebsanleitung. / Erection weights: see instruction manual. / Poids de montage: voir manuel de service. / Pesi di montaggio: vedasi le istruzioni sull'uso. / Peso para el montaje: según manual. / Pesos de montagem: vejã-m-se as instruções p. Uso.

Kranoberteil		Upper part of crane / Partie supérieure de grue / Parte superiore della gru		L (m)	B (m)	H (m)	kg*		
		Parte superior grúa / Parte superior do guindaste							
Pos. Item	Anz. Qty.	Drehbühne mit Podesten / Slewing platform with platforms Plate-forme tournante avec plates-formes / Piattaforma girevole con pedana / Plataforma giratoria con plataforma Plataforma giratória com plataforma			2,71	2,90	2,58	6220	
Rep. Voce Pos. Ref.	Qte. Qta. Cant.				2,71	2,25	2,58	5940	
1	1	Podeste / Platforms Plates-formes / Pedana Plataformas / Plataformas			2,33	0,50	1,36	120	
					2,40	1,04	1,33	150	
					2,33	0,65	1,36	120	
4	1	Kabine / Cabin Cabine / Cabina Cabina / Cabina			1,35	2,82	2,28	610	
5	1		Gegenausleger / Counter-jib Contre-flèche / Contrabaccio Contra-pluma / Contra-lança			11,98	1,40	0,81	2720
6	1	Podeste Gegenausleger / Counter-jib platforms Plates-formes de contre-flèche / Ballatoî controfrecchia Plataforma contra-pluma / Plataforma contra-lança				4,00	0,69	1,35	180
7	1		Ausleger-Anlenkstück / Jib heel section Pied de flèche / Settore articolato di braccio Pluma tramo primero / Base articulada de lança			10,01	1,34	2,23	① 2010
8	1	Ausleger-Zwischenstück / Intermediate jib section Élément intermédiaire de flèche / Spezzone di braccio Tramo intermedio pluma / Peça suplementar da lança				5,27	1,20	2,15	② 740
						10,26	1,20	2,14	③ 1180
						2,72	1,20	1,48	⑤ 200
						7,71	1,20	1,48	⑥ 500
9	1	Ausleger-Zwischenstück / Intermediate jib section Élément intermédiaire de flèche / Spezzone di braccio Tramo intermedio pluma / Peça suplementar da lança			5,19	1,20	1,46	⑦ 230	
					5,17	1,20	1,45	⑧ 200	
9	1	Ausleger-Zwischenstück / Intermediate jib section Élément intermédiaire de flèche / Spezzone di braccio Tramo intermedio pluma / Peça suplementar da lança			10,22	1,20	2,08	④ 850	

Pos. Item Rep. Voce Pos. Ref.	Anz. Qty. Qta. Cant. Cant.					L (m)	B (m)	H (m)	kg*	
10	1	Ausleger-Kopfstück / Jib head section Pointe de flèche / Punta freccia Tramo punta de pluma / Cabeça de lança				1,40	1,21	0,46	⊗ 80	
11	1	Laufkatze und Lasthaken / Trolley and hook Chariot de distribution et crochet / Carrello con gancio / Carrito y gancho / Carro de ponte e gancho				1,62	1,38	1,29	530	
12	1	Fahrkorb / Maintenance cage Nacelle d'entretien / Cestello di manutenzione Plataforma de mantenimiento				0,78	0,66	1,25	35	
Turm Tower / Mât / Torre Torre / Torre										
13	1	Grundturmstück / Base tower section Mât de base / Elemento di torre base Tramo base / Peça de base de torre				100 LC 12,00 120 HC 6,85 120 HC 10,00	2,03 1,80 1,80	2,03 1,80 1,80	3820 2610 3530	
						3,90 m 100 LC 4,17 5,85 m 100 LC 6,12 11,70 m 100 LC 11,97	1,80 1,80 1,80	1,80 1,80 1,80	1190 1620 2930	
14	1	Turmstück / Tower section Elément de mât / Elemento di torre Tramo torre / Torre				120 HC 2,50 120 HC 5,00 120 HC 10,00 120 HC 12,50	1,80 1,80 1,80 1,80	1,80 1,80 1,80 1,80	1090 1830 3430 4200	
Klettereinrichtung Climbing equipment / Equipement de télescopage / Attrezzatura per allungamento della gru Equipo de trepado / Acsórios p. subida no edificio										
15	1	Führungsstück kpl. / Guide section cpl. Cage télescopique cpl. / Gabbia de sopraelevazione compl. / Torre de montaje completa / Peça de guia compl.				100 LC 8,74 120 HC 6,45 120 HC 9,60	2,27 2,10 2,10	2,35 2,42 2,42	3130 3500 4440	
16	1	Führungsstück Turmstück / Tower guide section / Elément de mât télescopique Gabbia de sopraelevazione / Peça de guia Tramo torre de montaje				100 LC 4,17	2,26	2,26	1440	
17	1	Kletterturmstück / Climbing tower section Elément de hissage de mât / Elemento torre di telescopaggio / Tramo de trepado Tramo de telescopagem				120 HC 2,75	2,20	2,45	1450	
18	1	Hydraulikanlage, Stütz- und Klettertraverse / Hydraulic unit, supporting and climbing cross members / Système hydraul. avec traverses d'appui et de télescop. / Sist. idraul., traversa di appoggio e allugam. gru / Sistema hidráulico con traviesa de apoyo y trepado / Instalação hidráulica, tavessa de apoio e subida				100 LC 2,00 120 HC 2,87	0,90 2,12	0,80 1,06	640 1050	
Fundamentkreuz Cruciform base / Châssis en croix / Carro della gru Carro de guindaste / Base cruciforme										
19	1	Tragholm I / Arm I Longeron I / Longherone I Brazo I / Travessa I			(3,8 m) 100 LC 5,68 (4,5 m) 100 LC 6,67 120 HC 7,12	0,71 0,71 0,78	0,91 0,91 0,65	2090 2190 950		
20	1	Tragholm II / Arm II Longeron II / Longherone II Brazo II / Travessa II			(3,8 m) 100 LC 5,68 (4,5 m) 100 LC 6,67 120 HC 3,45	0,78 0,78 0,56	0,74 0,74 0,55	1870 1970 408		
21	2	Fahrschemel mit Antrieb / Rail bogie with drive / Bogie moteur / Telaço con grappa propulsore / Caja rodillo motriz Quadra sem grupa de propulsão				100 LC 1,31 120 HC 1,38	0,66 0,88	0,61 0,87	630 900	
22	2	Fahrschemel ohne Antrieb / Rail bogie without drive / Bogie fou / Telaço senza grappa propulsore / Caja rodillo conducido Quadra com grupa de propulsão				100 LC 1,04 120 HC 1,17	0,33 0,60	0,61 0,87	330 860	

* Einzelgewichte. / Single weights. / Poids individuels. / Pesì di componenti. / Pesos unitarios. / Pesos de peças componentes.

Konstruktionsänderungen vorbehalten!
Subject to alterations! / Sous réserves de modifications!
Si fa riserva di modifiche! / ¡Sujeto a modificaciones!
Salvo modificação da construçao!

Sämtliche Angaben erfolgen ohne Gewähr. / This information is supplied without liability.
Ces renseignements sont sans garantie. / Le indicazioni contenute si intendono salvo errori ed omissioni.
Declinamos toda responsabilidad derivada de la información proporcionada. / Declinamos qualquer
responsabilidade quanto à informação fornecida.

121 P – 5160 H1 B3 DIN 15018 • BGL C.0.10.0100 / FEM (Section 1) – Krangruppe A3 • 04.07 / 6

Printed in Germany.

Liebherr-Werk Biberach GmbH
Postfach 1663, D-88396 Biberach an der Riss
☎ +49 73 51 41-0, Fax: +49 73 51 41 22 25
www.liebherr.com, E-Mail: info.lbc@liebherr.com

Liebherr Industrias Metálicas, S.A.
Polígono Industrial Agustinos, Apartado 4096, E-31014 Pamplona
☎ +34-948-29 70 00, Fax +34-948-29 70 29
www.liebherr.com, E-Mail: info.lim@liebherr.com

110 EC-B 6 FR.tronic 6