

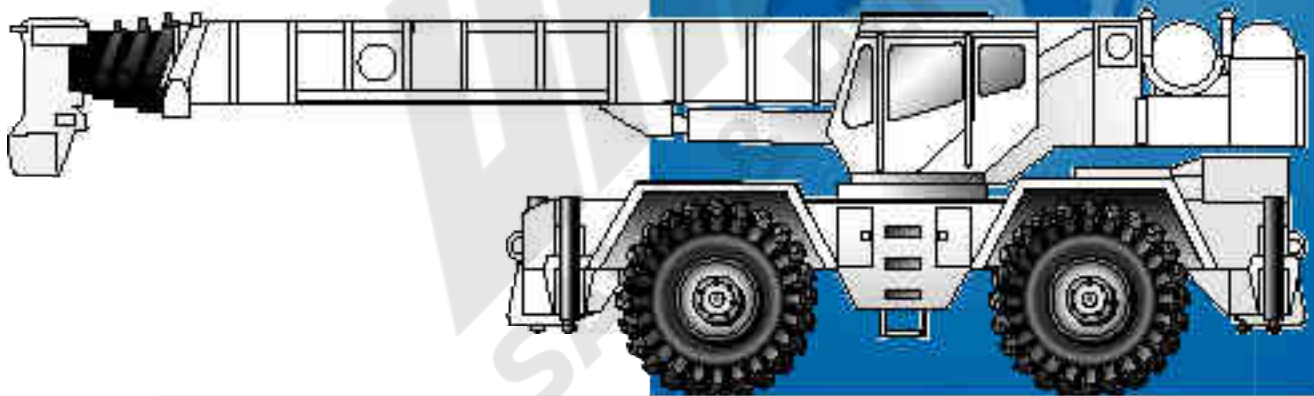

GROVE.
CRANE

RT870



Rough Terrain Hydraulic Crane

Dimensions

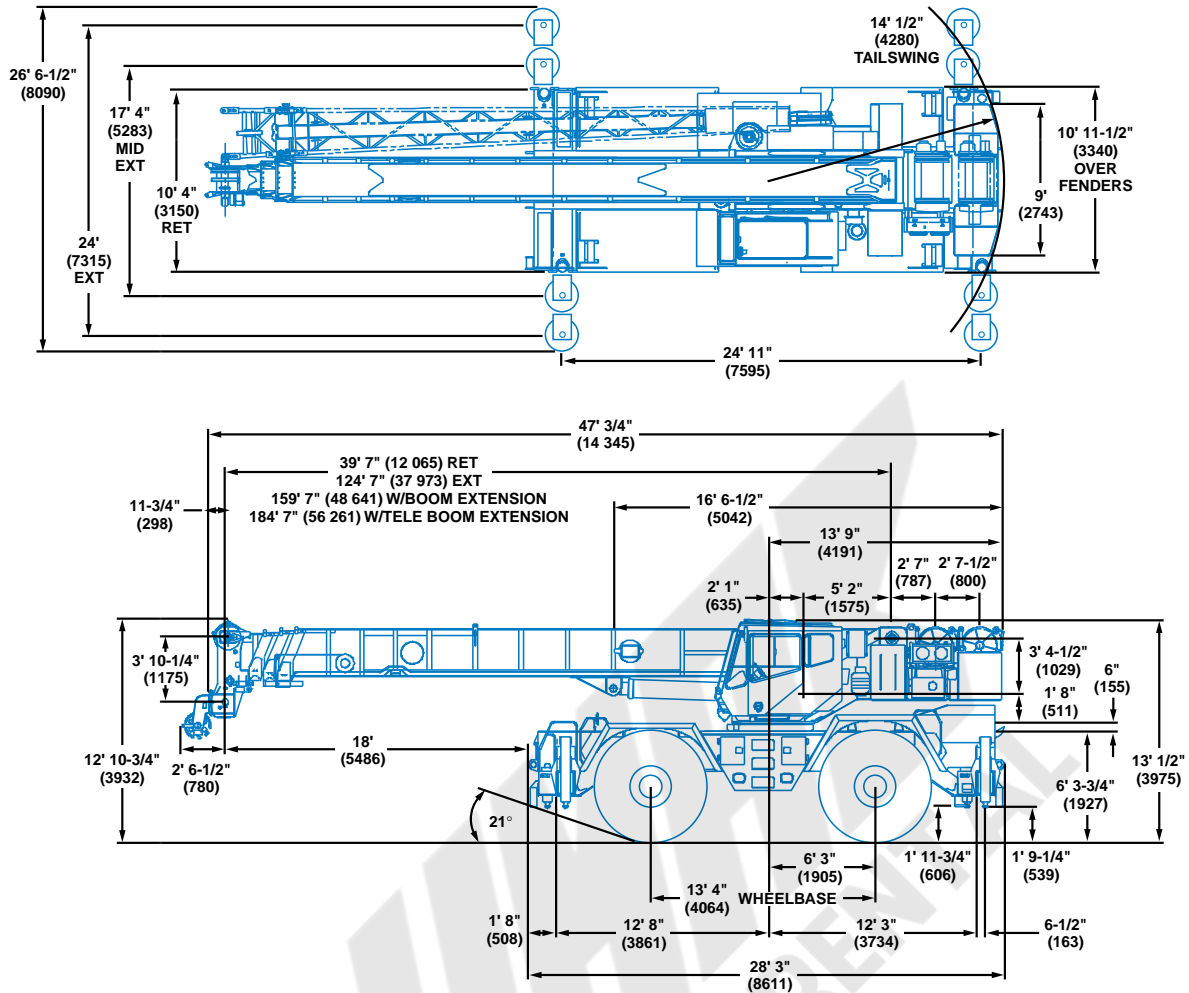

Note: () Reference dimensions in mm

- Turning Radius 22' 6" (6858 mm)
- Front Axle Load 55,235 lbs. (25 054 kg)
- Rear Axle Load 51,803 lbs. (23 498 kg)
- Gross Vehicle Weight 107,038 lbs. (48 552 kg)

Working range



40 - 125 ft.
(12 - 38 m)

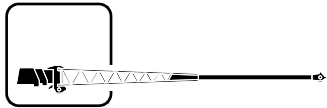

35 - 60 ft.
(10.6 - 18.2 m)



11,500 lbs.
(5216 kg)

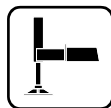

100%



360°

FEET

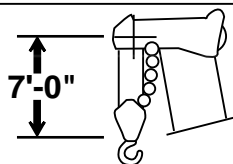
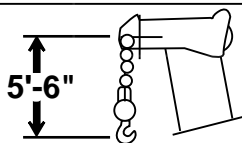
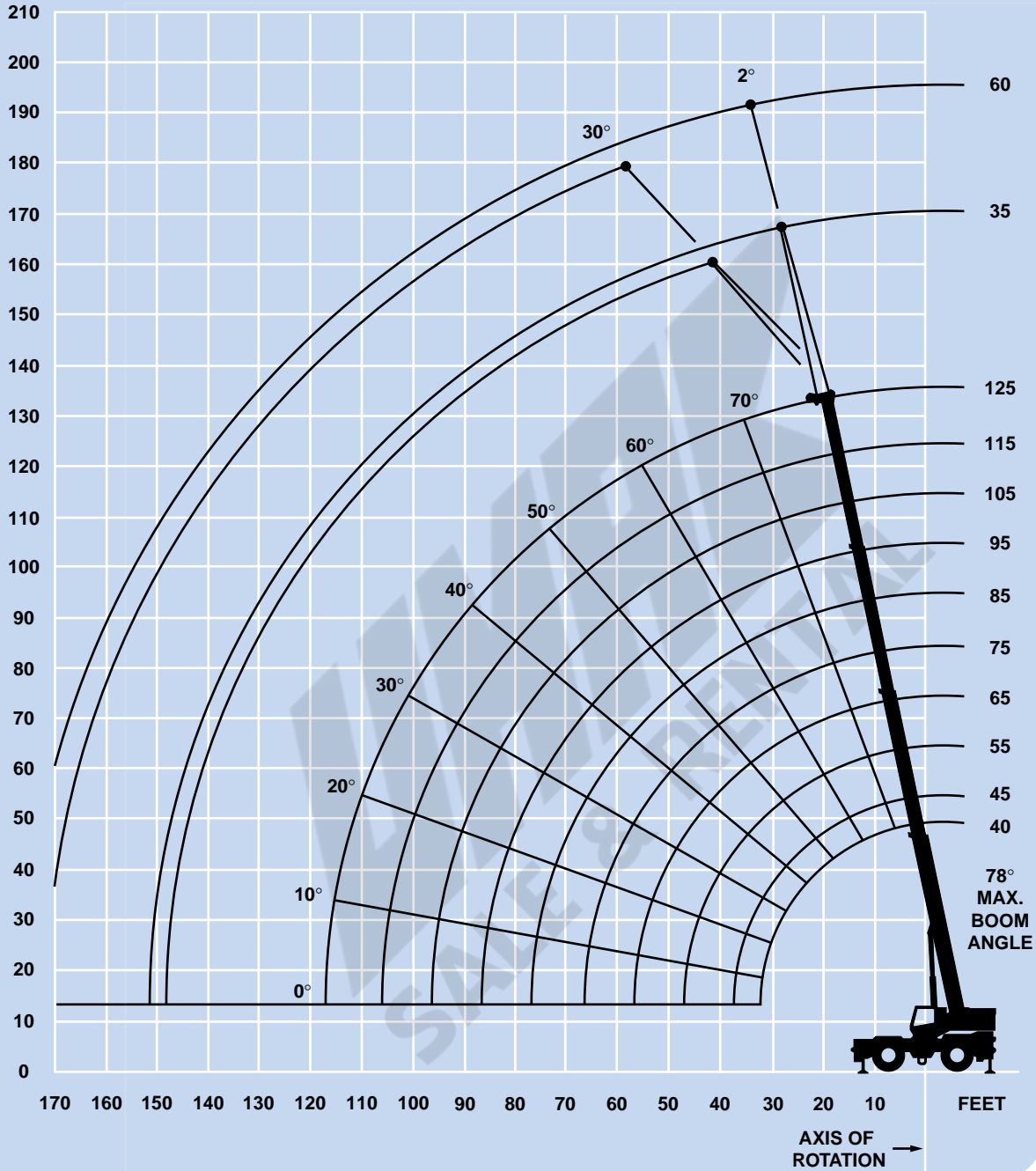

DIMENSIONS ARE FOR LARGEST GROVE FURNISHED HOOK BLOCK AND HEADACHE BALL, WITH ANTI-TWO BLOCK ACTIVATED.

Superstructure specifications

Boom

40 ft. - 125 ft. (12 m - 38 m) four-section, full power boom. Maximum tip height: 135 ft. (41 m).

Lattice Extension

35 ft. - 60 ft. (10.6 m - 18.2 m) telescoping lattice swingaway extension offsettable at 2° or 30°. Stows alongside base boom section.

Maximum tip height: 193 ft. (59 m).

*Optional Lattice Extension

35 ft. (10.6 m) lattice swingaway extension. Offsettable at 2° or 30°. Stows alongside base boom section.

Maximum tip height: 169 ft. (51.5 m).

Boom Nose

Six Nylatron sheaves mounted on heavy duty tapered roller bearings with removable pin-type rope guards. Quick reeving type boom nose. Removable auxiliary boom nose with removable pin type rope guard.

Boom Elevation

One double acting hydraulic cylinder with integral holding valve provides elevation from -3° to 78°.

Load Moment & Anti-Two Block System

Standard load moment and anti-two block system with audio-visual warning and control lever lockout. These systems provide electronic display of boom angle, boom length, radius, tip height, relative load moment, maximum permissible load, load indication and warning of impending two-block condition.

Cab

Full vision, all galvanealed steel fabricated with acoustical lining and tinted safety glass throughout. Deluxe seat with armrest mounted hydraulic single axis controllers. Dash panel incorporates gauges for all engine functions. Other standard features include: skylight screen, hydraulic oil cab heater/defroster, telescoping tilt wheel, sliding side and rear windows, opening skylight, electric windshield wash-wipe, electric skylight wipers, fire extinguisher, seat belt, ashtray and level indicator.

Swing

Planetary swing with foot applied multi-disc wet brake. Spring applied, hydraulically released swing brake, 360° positive swing lock (N.Y.C. style) and 1 position mechanical house lock, operated from cab. Maximum speed: 2.0 RPM.

Counterweight

Removable: 11,500 lbs. (5216 kg).

2,155 lbs. (977 kg) slab I.P.O. auxiliary hoist.

Hydraulic System

Seven main pumps with a combined capacity of 199.2 GPM (754 LPM).

Maximum operating pressure: 3500 psi (241 bar).

Three individual valve banks.

Return line type filter with full flow by-pass protection and service indicator. Replaceable cartridge with micron filtration rating of 5/12/16.

200 gallon (757 L) reservoir.

Remote mounted oil cooler with thermostatically controlled hydraulic motor driven fan/air to oil.

System pressure test panel with quick release type fittings for each circuit.

Hoist Specifications

Main and Auxiliary Hoist

Planetary reduction with automatic spring applied multi-disc brake. Electronic hoist drum rotation indicator, and hoist drum cable followers.

Maximum Single Line Pull:	16,969 lbs. (7697 kg)
Maximum Single Line Speed:	517 FPM (157 m/min)
Maximum Permissible Line Pull:	12,920 lbs. (5860 kg)
Rope Diameter:	3/4" (19 mm)
Rope Length:	650 ft. (198 m)
Maximum Rope Stowage:	1,163 ft. (354.5 m)

**Denotes optional equipment*

Carrier specifications

Chassis

Box section frame fabricated from high-strength, low alloy steel. Integral outrigger housings and front/rear towing and tie down lugs.

Outrigger System

Four hydraulic telescoping single-stage double box beam outriggers with inverted jacks and integral holding valves. Three position setting. All steel fabricated, quick release type outrigger floats, 30.5" (775 mm) diameter.
Maximum outrigger pad load: 101,524 lbs. (46 050 kg).

Outrigger Controls

Controls and crane level indicator located in cab.

Engine

Cummins 6CTA 8.3L diesel, six cylinders, turbocharged, 250 bhp (191 kW) (Gross) @ 2,500 RPM.
Maximum torque: 650 ft. lbs. (881 Nm) @ 1,800 RPM.

*Optional Engine

Caterpillar 3116TA diesel, six cylinders, turbocharged, 250 bhp (186 kW) (Gross) @ 2,500 RPM.
Maximum torque: 642 ft. lbs. (870 Nm) @ 1,600 RPM.

Fuel Tank Capacity

80 gallons (303 L)

Transmission

Full powershift with 6 forward and 6 reverse speeds.
Rear axle disconnect for 4 x 2 travel.

Electrical System

Two 12 V - maintenance free batteries.
24 V starting and lighting.

Drive

4 x 4.

Steering

Fully independent power steering:
Front: Full hydraulic steering wheel controlled.
Rear: Full hydraulic hand lever controlled.
Provides infinite variations of 4 main steering modes: front only, rear only, crab and coordinated.
Rear steer indicator gauge.

Axles

Front: Drive/steer with differential and planetary reduction hubs rigid mounted to frame.
Rear: Drive/steer with differential and planetary reduction hubs pivot mounted to frame.

Oscillation Lockouts

Automatic full hydraulic lockouts on rear axle permit oscillation only with boom centered over the front.

Brakes

Full air split circuit operating on all wheels. Spring-applied, air released parking brake operating on front and rear axles.

Tires

Std. 33.25 x 29 - 32PR earthmover type.
*Optional: 33.25R29 radial.

Lights

Full lighting including turn indicators, head, tail, brake and hazard warning lights.

Maximum Speed

25 MPH (40 kph).

Gradeability (Theoretical)

76% (Based on 104,031 lbs. [47 188 kg] GVW) 33.25 x 29 tires, pumps disengaged, 125 ft. (38 m) boom, plus 35 ft. (10.6 m) swingaway.

Miscellaneous Standard Equipment

Full width steel fenders, dual rear view mirrors, hook-block tiedown, electronic back-up alarm, light package, front stowage well, tachometer/hourmeter, cold start aid (less canister), rear wheel position indicator, hydraulic cab heater, hoist mirrors, engine distress A/V warning system, tire inflation kit.

*Optional Equipment

*Boom mounted worklights	*Air conditioning
*360° flashing light	*Dual axis joystick controllers
*Cab spotlights remote mounted	*Auxiliary oil cooler
*Engine block heater	*Emergency steer pump
*Hookblock (quick reeving type)	*Propane heater
*Tow winch - front mounted maximum pull: 15,000 lbs.(6804 kg); maximum speed: 92 ft/min. (28 m/min).	*T/T lube system
*Spare tire & wheel assembly	*Hoist mounted work light
*Tool kit	*Counterweight removal system
*Pintle hook front/rear	*3rd wrap indicators (main or auxiliary)
*High speed glide system	*LMI light bar
	*Cross axle differential locks
	*Oscillation lockout override control

**Denotes optional equipment*



40 - 125 ft.
(12 - 38 m)



11,500 lbs.
(5216 kg)



100%



360°



Pounds

Feet	40	45	55	65	75	85	95	105	115	125
10	140,000 (70)	105,000 (72.5)								
12	111,000 (67)	105,000 (70)	94,600 (74)							
15	91,450 (61.5)	91,000 (65.5)	88,250 (70.5)	71,050 (74)						
20	69,550 (52.5)	69,050 (58)	68,400 (65)	60,400 (69)	55,250 (72.5)	48,150 (75)				
25	55,050 (41.5)	54,600 (49.5)	53,950 (58.5)	53,450 (64.5)	47,950 (68.5)	41,700 (71.5)	38,000 (73.5)	33,350 (75.5)		
30	42,950 (26)	42,450 (39.5)	41,700 (52)	41,200 (59)	41,950 (64)	36,700 (67.5)	33,300 (70.5)	30,750 (72.5)	24,550 (75)	*23,700 (76.5)
35		33,700 (26)	33,000 (44.5)	32,500 (53.5)	33,250 (59.5)	32,600 (64)	29,550 (67)	27,300 (69.5)	21,700 (72)	21,900 (74)
40			26,650 (35.5)	26,150 (47.5)	26,900 (54.5)	27,850 (60)	26,450 (63.5)	24,450 (66.5)	19,350 (69.5)	20,300 (71.5)
45			21,750 (23)	21,300 (40.5)	22,050 (49.5)	23,000 (55.5)	23,700 (60)	22,000 (63.5)	17,450 (66.5)	18,800 (69)
50				17,500 (32.5)	18,250 (44)	19,150 (51.5)	19,900 (56.5)	19,850 (60.5)	15,800 (64)	17,050 (66.5)
60					12,400 (30)	13,250 (41.5)	14,100 (48.5)	14,650 (53.5)	13,250 (58)	14,150 (61.5)
70						9,190 (28.5)	9,910 (39)	10,400 (46)	10,850 (51.5)	11,350 (55.5)
80							6,930 (27)	6,740 (37)	7,850 (44.5)	8,290 (49.5)
90								5,170 (25.5)	5,600 (36)	6,010 (42.5)
100									3,880 (25)	4,250 (34.5)
110										2,840 (24)
Minimum boom angle (deg.) for indicated length (no load)										0
Maximum boom length (ft.) at 0 degree boom angle (no load)										125

NOTE: () Boom angles are in degrees.
*Based on maximum obtainable boom angle.

A6-829-016051

Boom Angle	40	45	55	65	75	85	95	105	115
0°	22,800 (32.3)	18,250 (37.8)	12,200 (47.8)	7,990 (57.8)	5,720 (67.8)	4,320 (77.8)	3,210 (87.8)	2,380 (97.8)	1,570 (107.8)

NOTE: () Reference radii are in feet.

A6-829-012282



40 - 125 ft.
(12 - 38 m)



11,500 lbs.
(5216 kg)



50%
17' 4" Spread



360°



Pounds

Feet	40	45	55	65	75	85	95	105	115	125
10	116,000 (70)	105,000 (72.5)								
12	102,500 (67)	102,000 (70)	94,600 (74)							
15	86,800 (61.5)	86,350 (65.5)	85,800 (70.5)	71,050 (74)						
20	67,250 (52.5)	64,850 (58)	60,550 (65)	56,950 (69)	55,250 (72.5)	48,150 (75)				
25	45,750 (41.5)	44,950 (49.5)	42,050 (58.5)	39,700 (64.5)	39,100 (68.5)	38,900 (71.5)	38,000 (73.5)	33,350 (75.5)		
30	32,500 (26)	32,050 (39.5)	31,000 (52)	29,250 (59)	29,050 (64)	29,250 (67.5)	29,300 (70.5)	29,250 (72.5)	24,550 (75)	*23,700 (76.5)
35		23,900 (26)	23,350 (44.5)	22,250 (53.5)	22,300 (59.5)	22,700 (64)	22,900 (67)	23,050 (69.5)	21,700 (72)	21,900 (74)
40			17,650 (35.5)	17,200 (47.5)	17,400 (54.5)	17,900 (60)	18,250 (63.5)	18,550 (66.5)	18,550 (69.5)	18,550 (71.5)
45			13,400 (23)	13,000 (40.5)	13,600 (49.5)	14,300 (55.5)	14,700 (60)	15,050 (63.5)	15,150 (66.5)	15,250 (69)
50				9,850 (32.5)	10,450 (44)	11,450 (51.5)	11,900 (56.5)	12,350 (60.5)	12,450 (64)	12,600 (66.5)
60					5,970 (30)	6,940 (41.5)	7,840 (48.5)	8,310 (53.5)	8,500 (58)	8,700 (61.5)
70						4,020 (28.5)	4,840 (39)	5,410 (46)	5,700 (51.5)	5,930 (55.5)
80							2,630 (27)	3,170 (37)	3,620 (44.5)	3,870 (49.5)
90								1,490 (25.5)	2,000 (36)	2,280 (42.5)
100										1,020 (34.5)

Minimum boom angle (deg.) for indicated length (no load)

27.5

Maximum boom length (ft.) at 0 degree boom angle (no load)

105

NOTE: () Boom angles are in degrees.

*Based on maximum obtainable boom angle.

A6-829-011802A

Boom Angle	40	45	55	65	75	85	95
0°	22,800 (32.3)	18,250 (37.8)	11,500 (47.8)	6,220 (57.8)	3,740 (67.8)	2,350 (77.8)	1,300 (87.8)

NOTE: () Reference radii are in feet.

A6-829-012282



40 - 125 ft.
(12 - 38 m)



11,500 lbs.
(5216 kg)



0%
10' 4" Spread



360°



Pounds

Feet	40	45	55	65	75	85	95	105	115	125
10	91,900 (70)	86,850 (72.5)								
12	70,100 (67)	66,600 (70)	61,200 (74)							
15	50,500 (61.5)	48,150 (65.5)	44,550 (70.5)	41,550 (74)						
20	31,200 (52.5)	30,950 (58)	28,900 (65)	26,950 (69)	26,600 (72.5)	26,600 (75)				
25	20,850 (41.5)	20,550 (49.5)	19,900 (58.5)	18,500 (64.5)	18,500 (68.5)	18,800 (71.5)	18,950 (73.5)	19,050 (75.5)		
30	14,650 (26)	14,350 (39.5)	13,850 (52)	12,950 (59)	13,850 (64)	13,650 (67.5)	13,950 (70.5)	14,200 (72.5)	14,200 (75)	*14,200 (76.5)
35		10,200 (26)	9,750 (44.5)	9,090 (53.5)	9,370 (59.5)	9,970 (64)	10,350 (67)	10,700 (69.5)	10,750 (72)	10,850 (74)
40			6,810 (35.5)	6,190 (47.5)	6,550 (54.5)	7,200 (60)	7,660 (63.5)	8,070 (66.5)	8,200 (69.5)	8,350 (71.5)
45			4,600 (23)	3,950 (40.5)	4,350 (49.5)	5,040 (55.5)	5,540 (60)	5,990 (63.5)	6,170 (66.5)	6,360 (69)
50				2,170 (32.5)	2,610 (44)	3,320 (51.5)	3,850 (56.5)	4,330 (60.5)	4,540 (64)	4,750 (66.5)
60							1,300 (48.5)	1,820 (53.5)	2,070 (58)	2,320 (61.5)

Minimum boom angle (deg.) for indicated length (no load)

51

Maximum boom length (ft.) at 0 degree boom angle (no load)

65

NOTE: () Boom angles are in degrees.

*Based on maximum obtainable boom angle.

A6-829-011927A

Boom
Angle

	40	45	55
0°	12,550 (32.3)	8,440 (37.8)	3,610 (47.8)

NOTE: () Reference radii are in feet.

A6-829-012282



40 - 125 ft.
(12 - 38 m)



0 lbs.
(0 kg)



100%



360°



Pounds

Feet	40	45	55	65	75	85	95	105	115	125
10	121,500 (70)	105,000 (72.5)								
12	105,000 (67)	104,500 (70)	94,600 (74)							
15	86,050 (61.5)	85,550 (65.5)	84,900 (70.5)	71,050 (74)						
20	65,000 (52.5)	64,550 (58)	63,900 (65)	60,400 (69)	55,250 (72.5)	48,150 (75)				
25	47,550 (41.5)	46,950 (49.5)	46,150 (58.5)	45,600 (64.5)	46,350 (68.5)	41,700 (71.5)	38,000 (73.5)	33,350 (75.5)		
30	36,250 (26)	35,750 (39.5)	35,000 (52)	34,450 (59)	35,200 (64)	36,200 (67.5)	33,300 (70.5)	30,750 (72.5)	24,550 (75)	*23,700 (76.5)
35		28,000 (26)	27,350 (44.5)	26,850 (53.5)	27,550 (59.5)	28,550 (64)	29,300 (67)	27,300 (69.5)	21,700 (72)	21,900 (74)
40			21,750 (35.5)	21,250 (47.5)	22,000 (54.5)	22,950 (60)	23,650 (63.5)	24,250 (66.5)	19,350 (69.5)	20,300 (71.5)
45			16,200 (23)	15,900 (40.5)	16,750 (49.5)	17,900 (55.5)	18,900 (60)	19,650 (63.5)	17,450 (66.5)	18,800 (69)
50				11,600 (32.5)	12,500 (44)	13,900 (51.5)	15,000 (56.5)	15,700 (60.5)	15,800 (64)	17,050 (66.5)
60					6,630 (30)	8,120 (41.5)	9,600 (48.5)	10,250 (53.5)	10,900 (58)	11,450 (61.5)
70						4,620 (28.5)	5,870 (39)	6,540 (46)	7,210 (51.5)	7,820 (55.5)
80							3,240 (27)	3,910 (37)	4,590 (44.5)	5,240 (49.5)
90								2,000 (25.5)	2,660 (36)	3,290 (42.5)
100									1,230 (25)	1,790 (34.5)

Minimum boom angle (deg.) for indicated length (no load)

22

Maximum boom length (ft.) at 0 degree boom angle (no load)

105

NOTE: () Boom angles are in degrees.

*Based on maximum obtainable boom angle.

A6-829-012262

Boom Angle	40	45	55	65	75	85	95
0°	22,800 (32.3)	18,250 (37.8)	12,200 (47.8)	6,760 (57.8)	4,000 (67.8)	2,660 (77.8)	1,680 (87.8)

NOTE: () Reference radii are in feet.

A6-829-012283



40 - 125 ft.
(12 - 38 m)



0 lbs.
(0 kg)



50%
17' 4" Spread



360°



Pounds

Feet	40	45	55	65	75	85	95	105	115	125
10	116,000 (70)	105,000 (72.5)								
12	102,500 (67)	102,000 (70)	94,600 (74)							
15	84,600 (61.5)	80,100 (65.5)	73,300 (70.5)	67,700 (74)						
20	50,200 (52.5)	47,750 (58)	44,200 (65)	41,250 (69)	40,300 (72.5)	39,850 (75)				
25	33,550 (41.5)	32,250 (49.5)	29,800 (58.5)	27,800 (64.5)	27,550 (68.5)	27,700 (71.5)	27,650 (73.5)	27,550 (75.5)		
30	23,200 (26)	22,750 (39.5)	21,200 (52)	19,700 (59)	19,750 (64)	20,150 (67.5)	20,350 (70.5)	20,550 (72.5)	20,400 (75)	*20,300 (76.5)
35		16,350 (26)	15,500 (44.5)	14,250 (53.5)	14,450 (59.5)	15,000 (64)	15,350 (67)	15,650 (69.5)	15,700 (72)	15,700 (74)
40			11,400 (35.5)	10,300 (47.5)	10,650 (54.5)	11,300 (60)	11,750 (63.5)	12,100 (66.5)	12,200 (69.5)	12,300 (71.5)
45			8,300 (23)	7,400 (40.5)	7,780 (49.5)	8,484 (55.5)	8,970 (60)	9,420 (63.5)	9,570 (66.5)	9,730 (69)
50				5,120 (32.5)	5,530 (44)	6,260 (51.5)	6,790 (56.5)	7,270 (60.5)	7,460 (64)	7,660 (66.5)
60					2,250 (30)	3,010 (41.5)	3,580 (48.5)	4,100 (53.5)	4,340 (58)	4,580 (61.5)
70							1,330 (39)	1,870 (46)	2,130 (51.5)	2,410 (55.5)
Minimum boom angle (deg.) for indicated length (no load)										44
Maximum boom length (ft.) at 0 degree boom angle (no load)										68

NOTE: () Boom angles are in degrees.
*Based on maximum obtainable boom angle.

A6-829-012263

Boom Angle	40	45	55	65
0°	19,600 (32.3)	13,550 (37.8)	6,750 (47.8)	2,550 (57.8)

NOTE: () Reference radii are in feet.

A6-829-012283



40 - 125 ft.
(12 - 38 m)



0 lbs.
(0 kg)



0%
10' 4" Spread



360°



Pounds

Feet	40	45	55	65	75	85	95	105	115	125
10	65,200 (70)	61,200 (72.5)								
12	49,000 (67)	46,200 (70)	41,900 (74)							
15	34,400 (61.5)	32,500 (65.5)	29,550 (70.5)	27,150 (74)						
20	21,050 (52.5)	19,900 (58)	17,950 (65)	16,400 (69)	16,300 (72.5)	16,600 (75)				
25	13,550 (41.5)	12,850 (49.5)	11,300 (58.5)	10,100 (64.5)	10,300 (68.5)	10,850 (71.5)	11,150 (73.5)	11,400 (75.5)		
30	9,070 (26)	8,320 (39.5)	7,030 (52)	6,040 (59)	6,360 (64)	6,990 (67.5)	7,420 (70.5)	7,800 (72.5)	7,900 (75)	*8,000 (76.5)
35		5,190 (26)	4,020 (44.5)	3,140 (53.5)	3,550 (59.5)	4,240 (64)	4,740 (67)	5,180 (69.5)	5,350 (72)	5,520 (74)
40					1,450 (54.5)	2,180 (60)	2,720 (63.5)	3,200 (66.5)	3,410 (69.5)	3,620 (71.5)
45							1,140 (60)	1,650 (63.5)	1,890 (66.5)	2,130 (69)
Minimum boom angle (deg.) for indicated length (no load)										61.5
Maximum boom length (ft.) at 0 degree boom angle (no load)										55

NOTE: () Boom angles are in degrees.

*Based on maximum obtainable boom angle.

A6-829-012264

Boom Angle	40	45
0°	7,540 (32.3)	3,970 (37.8)

NOTE: () Reference radii are in feet.

A6-829-012283

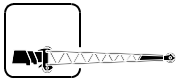

35 ft.
(10.6 m)



11,500 lbs.
(5216 kg)



100%



360°

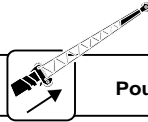

Pounds

Feet

2° OFFSET

30° OFFSET

Feet	2° OFFSET	30° OFFSET
40	*12,900 (77)	
45	11,900 (75.5)	
50	11,200 (73.5)	
55	10,600 (71.5)	*7,800 (77)
60	10,050 (69.5)	7,530 (74.5)
65	9,650 (67.5)	7,410 (72.5)
70	9,110 (65.5)	7,280 (70.5)
75	8,700 (63.5)	7,160 (68)
80	8,330 (61.5)	7,050 (66)
85	7,990 (59)	6,950 (64)
90	7,330 (57)	6,850 (61.5)
95	6,330 (54.5)	6,330 (59)
100	5,450 (52.5)	5,450 (56.5)
105	4,660 (50)	4,660 (54)
110	3,950 (47.5)	3,950 (51.5)
115	3,310 (44.5)	3,310 (48.5)
120	2,730 (41.5)	2,730 (45.5)
125	2,200 (38.5)	2,200 (42.5)
130	1,710 (35.5)	1,710 (38.5)
135	1,270 (31.5)	1,270 (34.5)

NOTE: () Boom angles are in degrees.
*This capacity is based upon maximum boom angle.

A6-829-012285

SALE & RENTAL

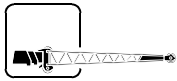

35 ft.
(10.6 m)



11,500 lbs.
(5216 kg)



50%
17' 4" Spread



360°

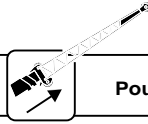

Pounds

Feet	2° OFFSET	30° OFFSET
40	*12,900 (77)	
45	11,900 (75.5)	
50	11,200 (73.5)	
55	10,500 (71.5)	*7,800 (77)
60	8,830 (69.5)	7,530 (74.5)
65	7,400 (67.5)	7,400 (72.5)
70	6,180 (65.5)	6,180 (70.5)
75	5,110 (63.5)	5,110 (68)
80	4,190 (61.5)	4,190 (66)
85	3,370 (59)	3,370 (64)
90	2,640 (57)	2,640 (61.5)
95	1,990 (54.5)	1,990 (59)
100	1,400 (52.5)	1,400 (56.5)

NOTE: () Boom angles are in degrees.
*This capacity is based upon maximum boom angle.

A6-829-012288

WMA
SALE & RENTAL

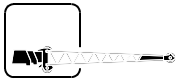

35 ft.
(10.6 m)



0 lbs.
(0 kg)



100%



360°



Feet	2° OFFSET	30° OFFSET
40	*12,900 (77)	
45	11,900 (75.5)	
50	11,200 (73.5)	
55	10,600 (71.5)	*7,800 (77)
60	10,050 (69.5)	7,530 (74.5)
65	9,650 (67.5)	7,410 (72.5)
70	9,110 (65.5)	7,280 (70.5)
75	7,960 (63.5)	7,160 (68)
80	6,690 (61.5)	6,690 (66)
85	5,580 (59)	5,580 (64)
90	4,630 (57)	4,630 (61.5)
95	3,780 (54.5)	3,780 (59)
100	3,030 (52.5)	3,030 (56.5)
105	2,360 (50)	2,360 (54)
110	1,760 (47.5)	1,760 (51.5)
115	1,220 (44.5)	1,220 (48.5)

NOTE: () Boom angles are in degrees.
*This capacity is based upon maximum boom angle.

A6-829-012289

WMA
SALE & RENTAL



35 - 60 ft.
(10.6 - 18.2 m)



11,500 lbs.
(5216 kg)



100%



360°

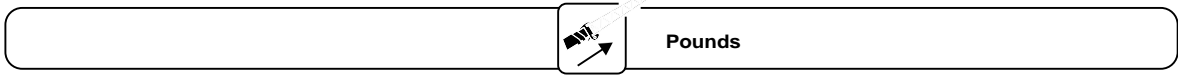

35 ft

60 ft

Feet	2° OFFSET	30° OFFSET	2° OFFSET	30° OFFSET
40	*12,900 (77)			
45	11,600 (75.5)			
50	10,900 (73.5)		*6,700 (77)	
55	10,300 (71.5)	*7,500 (77)	6,320 (75)	
60	9,750 (69.5)	7,250 (74.5)	6,000 (73.5)	
65	9,250 (67.5)	7,110 (72.5)	5,630 (71.5)	
70	8,810 (65.5)	6,980 (70.5)	5,260 (70)	
75	8,400 (63.5)	6,860 (68)	4,900 (68.5)	*4,000 (77)
80	8,030 (61.5)	6,750 (66)	4,630 (66.5)	3,700 (74.5)
85	7,690 (59)	6,650 (64)	4,360 (65)	3,500 (73)
90	6,840 (57)	6,560 (61.5)	4,100 (63)	3,350 (71)
95	5,840 (54.5)	5,840 (59)	3,800 (61)	3,270 (69)
100	4,950 (52.5)	4,950 (56.5)	3,640 (59.5)	3,210 (67)
105	4,160 (50)	4,160 (54)	3,490 (57.5)	3,150 (65)
110	3,450 (47.5)	3,450 (51.5)	3,350 (55.5)	3,100 (63)
115	2,810 (44.5)	2,810 (48.5)	3,220 (53.5)	3,050 (61)
120	2,230 (41.5)	2,230 (45.5)	3,100 (51)	3,010 (58.5)
125	1,700 (38.5)	1,700 (42.5)	2,990 (49)	2,970 (56.5)
130	1,210 (35.5)	1,210 (38.5)	2,770 (47)	2,770 (54)
135			2,290 (44.5)	2,290 (51.5)
140			1,850 (42)	1,850 (48.5)
145			1,450 (39.5)	1,450 (46)
150			1,070 (36.5)	1,070 (42.5)

NOTE: () Boom angles are in degrees.

*This capacity is based upon maximum boom angle.

A6-829-011806A



35 - 60 ft.
(10.6 - 18.2 m)



11,500 lbs.
(5216 kg)



50%
17' 4" Spread



360°



Feet	35 ft.		60 ft.	
	2° OFFSET	30° OFFSET	2° OFFSET	30° OFFSET
40	*12,900 (77)			
45	11,600 (75.5)			
50	10,900 (73.5)		*6,700 (77)	
55	9,880 (71.5)	*7,500 (77)	6,320 (75)	
60	8,190 (69.5)	7,250 (74.5)	6,000 (73.5)	
65	6,760 (67.5)	6,760 (72.5)	5,630 (71.5)	
70	5,530 (65.5)	5,530 (70.5)	5,260 (70)	
75	4,470 (63.5)	4,470 (68)	4,900 (68.5)	*4,000 (77)
80	3,540 (61.5)	3,540 (66)	4,630 (66.5)	3,700 (74.5)
85	2,720 (59)	2,720 (64)	4,090 (65)	3,500 (73)
90	1,990 (57)	1,990 (61.5)	3,360 (63)	3,350 (71)
95	1,340 (54.5)	1,340 (59)	2,710 (61)	2,710 (69)
100			2,130 (59.5)	2,130 (67)
105			1,600 (57.5)	1,600 (65)
110			1,120 (55.5)	1,120 (63)

NOTE: () Boom angles are in degrees.
*This capacity is based upon maximum boom angle.

A6-829-011807A

WINDY
SALE & RENTAL

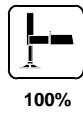
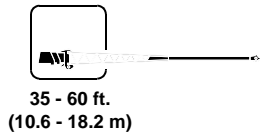

35 ft.

60 ft.

Feet	2° OFFSET	30° OFFSET	2° OFFSET	30° OFFSET
40	*12,900 (77)			
45	11,600 (75.5)			
50	10,900 (73.5)		*6,700 (77)	
55	10,300 (71.5)	*7,500 (77)	6,320 (75)	
60	9,750 (69.5)	7,250 (74.5)	6,000 (73.5)	
65	9,250 (67.5)	7,110 (72.5)	5,630 (71.5)	
70	8,810 (65.5)	6,980 (70.5)	5,260 (70)	
75	7,400 (63.5)	6,860 (68)	4,900 (68.5)	*4,000 (77)
80	6,070 (61.5)	6,070 (66)	4,630 (66.5)	3,700 (74.5)
85	4,930 (59)	4,930 (64)	4,360 (65)	3,500 (73)
90	3,930 (57)	3,930 (61.5)	4,100 (63)	3,350 (71)
95	3,050 (54.5)	3,050 (59)	3,800 (61)	3,270 (69)
100	2,270 (52.5)	2,270 (56.5)	3,640 (59.5)	3,210 (67)
105	1,580 (50)	1,580 (54)	3,490 (57.5)	3,150 (65)
110			3,240 (55.5)	3,100 (63)
115			2,530 (53.5)	2,530 (61)
120			1,880 (51)	1,880 (58.5)
125			1,300 (49)	1,300 (56.5)

NOTE: () Boom angles are in degrees.
 *This capacity is based upon maximum boom angle.

A6-829-012281



40 - 125 ft.
(12 - 38 m)



11,500 lbs.
(5216 kg)



33.25 x 29
(32 Ply)
Stationary



360°



Pounds

Feet	40	45	55	65	75	85	95
10	66,250 (70.5)	63,400 (73)					
12	51,800 (67.5)	51,500 (70.5)	50,900 (74.5)				
15	35,850 (62.5)	35,450 (66)	33,500 (71)	30,800 (74.5)			
20	21,500 (53.5)	21,200 (58.5)	20,650 (65)	18,950 (69.5)	21,250 (72.5)	18,200 (75)	
25	14,050 (42.5)	13,800 (50)	13,300 (59)	12,850 (64.5)	13,650 (68.5)	14,800 (71.5)	13,950 (74)
30	9,430 (28)	8,920 (40)	8,590 (52)	8,260 (59.5)	8,470 (64)	8,920 (68)	9,980 (70.5)
35		5,750 (26.5)	5,100 (44.5)	4,460 (54)	5,000 (59.5)	6,060 (64)	6,500 (67.5)
40			3,000 (35.5)	2,160 (47.5)	3,260 (55)	3,870 (60)	4,100 (64)
45							2,330 (60.5)

NOTE: () Boom angles are in degrees.

A6-829-012279

Boom Angle	40	45
0°	7,420 (32.3)	4,770 (37.8)

NOTE: () Reference radii are in feet.

A6-829-012282

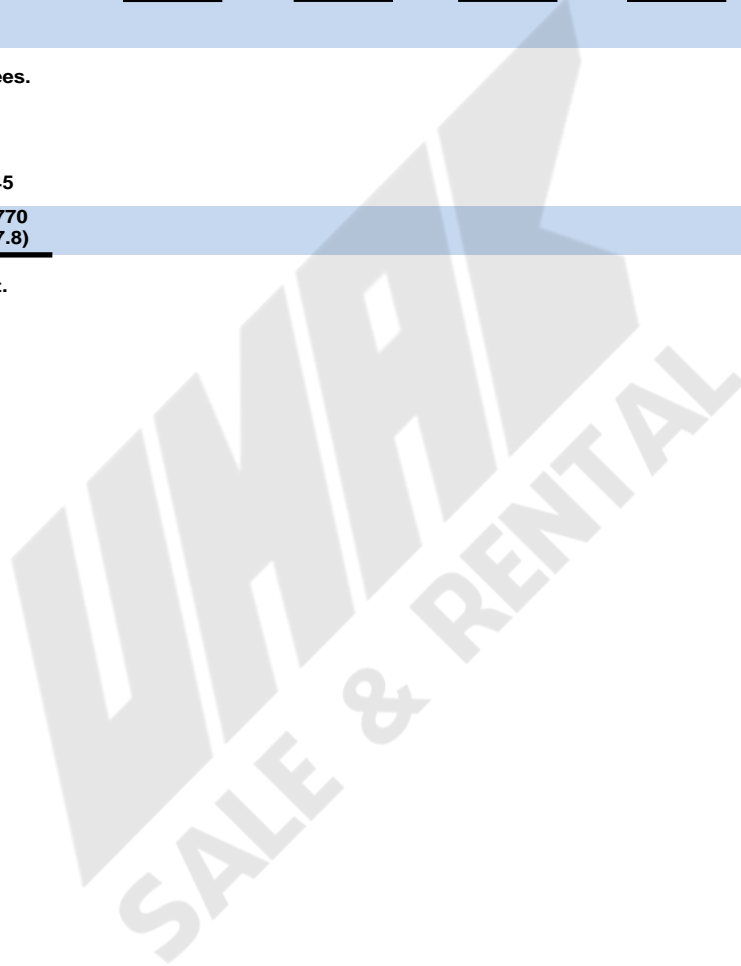



40 - 125 ft.
(12 - 38 m)



11,500 lbs.
(5216 kg)



33.25 x 29
(32 Ply)
Stationary



Defined Arc
Over Front
±6°



Pounds

Feet	40	45	55	65	75	85	95
10	86,100 (70.5)	72,250 (73)					
12	76,400 (67.5)	61,250 (70.5)	51,600 (74.5)				
15	63,250 (62.5)	49,350 (66)	44,300 (71)	42,950 (74.5)			
20	47,850 (53.5)	36,450 (58.5)	34,700 (65)	33,300 (69.5)	34,300 (72.5)	20,150 (75)	13,950 (77)
25	32,650 (42.5)	28,150 (50)	27,400 (59)	26,150 (64.5)	26,700 (68.5)	20,150 (71.5)	13,950 (74)
30	23,200 (28)	22,400 (40)	21,600 (52)	20,550 (59.5)	20,950 (64)	20,150 (68)	13,950 (70.5)
35		16,850 (26.5)	16,500 (44.5)	16,100 (54)	16,500 (59.5)	16,750 (64)	13,950 (67.5)
40			12,250 (35.5)	11,950 (47.5)	12,550 (55)	13,350 (60)	13,950 (64)
45			9,140 (23.5)	8,870 (41)	9,450 (50)	9,980 (56)	11,050 (60.5)
50				6,510 (32.5)	7,070 (44)	7,790 (51.5)	8,620 (56.5)
60					3,620 (30)	4,400 (41.5)	4,770 (48.5)
70						1,910 (28.5)	2,740 (39.5)

NOTE: () Boom angles are in degrees.

A6-829-012278

Boom Angle	40	45	55	65	75
0°	20,050 (32.3)	14,300 (37.8)	7,750 (47.8)	3,570 (57.8)	1,300 (67.8)

NOTE: () Reference radii are in feet.

A6-829-012282

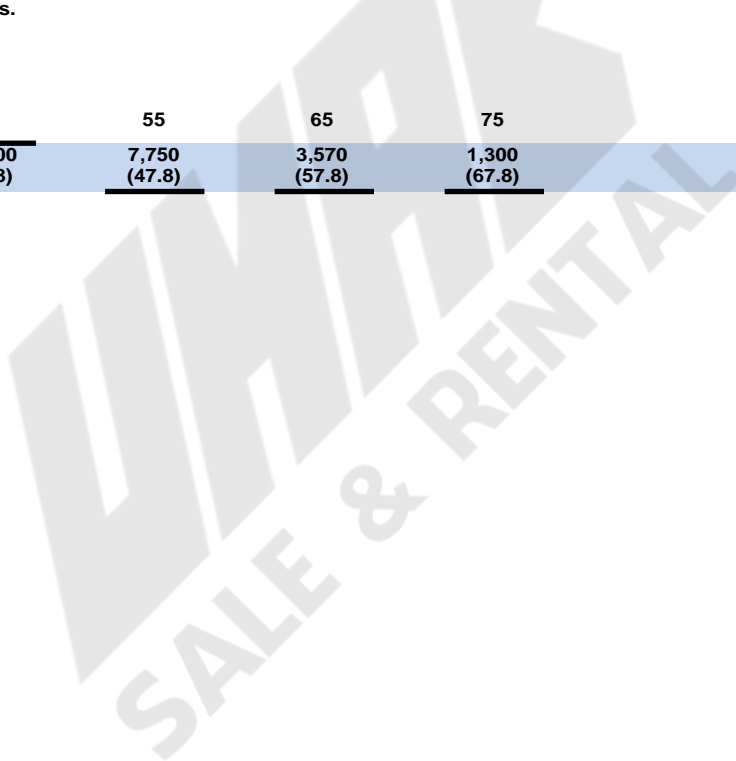



40 - 125 ft.
(12 - 38 m)



11,500 lbs.
(5216 kg)



33.25 x 29
Pick & Carry
Up to 2.5 MPH



Boom Centered
Over Front



Pounds

Feet	40	45	55	65	75	85	95
10	87,650 (70.5)	84,400 (73)					
12	76,500 (67.5)	74,250 (70.5)	69,200 (74.5)				
15	63,700 (62.5)	63,500 (66)	56,400 (71)	52,100 (74.5)			
20	48,850 (53.5)	48,650 (58.5)	43,700 (65)	38,300 (69.5)	38,300 (72.5)	30,100 (75)	21,400 (77)
25	32,650 (42.5)	32,400 (50)	31,900 (59)	30,100 (64.5)	30,100 (68.5)	27,150 (71.5)	21,400 (74)
30	23,200 (28)	22,950 (40)	22,250 (52)	22,100 (59.5)	22,850 (64)	24,000 (68)	21,400 (70.5)
35		16,850 (26.5)	16,500 (44.5)	16,100 (54)	16,750 (59.5)	17,850 (64)	18,900 (67.5)
40			12,250 (35.5)	11,950 (47.5)	12,550 (55)	13,550 (60)	14,500 (64)
45			9,140 (23.5)	8,870 (41)	9,450 (50)	10,350 (56)	11,300 (60.5)
50				6,510 (32.5)	7,070 (44)	7,950 (51.5)	8,840 (56.5)
60					3,650 (30)	4,470 (41.5)	5,290 (48.5)
70						2,180 (28.5)	2,870 (39.5)
80							1,120 (27)

NOTE: () Boom angles are in degrees.

A6-829-012280

Boom Angle	40	45	55	65	75
0°	20,050 (32.3)	14,300 (37.8)	7,750 (47.8)	3,770 (57.8)	1,900 (67.8)

NOTE: () Reference radii are in feet.

A6-829-012282

SALE & RENTAL



40 - 125 ft.
(12 - 38 m)



11,500 lbs.
(5216 kg)



33.25 R29
XRB** Tires
Stationary



360°



Pounds

Feet	40	45	55	65	75	85	95
10	67,850 (70.5)	62,500 (73)					
12	52,750 (67.5)	49,450 (70.5)	47,150 (74.5)				
15	36,700 (62.5)	36,250 (66)	35,050 (71)	29,900 (74.5)	19,150 (77)		
20	22,100 (53.5)	21,850 (58.5)	21,400 (65)	20,950 (69.5)	13,550 (72.5)	13,550 (75)	
25	14,550 (42.5)	14,250 (50)	13,750 (59)	13,100 (64.5)	9,650 (68.5)	9,650 (71.5)	9,650 (74)
30	9,460 (28)	9,470 (40)	9,080 (52)	8,270 (59.5)	6,770 (64)	6,770 (68)	6,770 (70.5)
35		5,600 (26.5)	5,350 (44.5)	4,950 (54)	4,570 (59.5)	4,570 (64)	4,570 (67.5)
40			2,660 (35.5)	2,540 (47.5)	2,520 (55)	2,520 (60)	2,520 (64)
45					1,410 (50)	1,410 (56)	1,410 (60.5)

NOTE: () Boom angles are in degrees.

A6-829-011804B

Boom Angle	40	45
0°	7,450 (32.3)	3,900 (37.8)

NOTE: () Reference radii are in feet.

A6-829-011934A

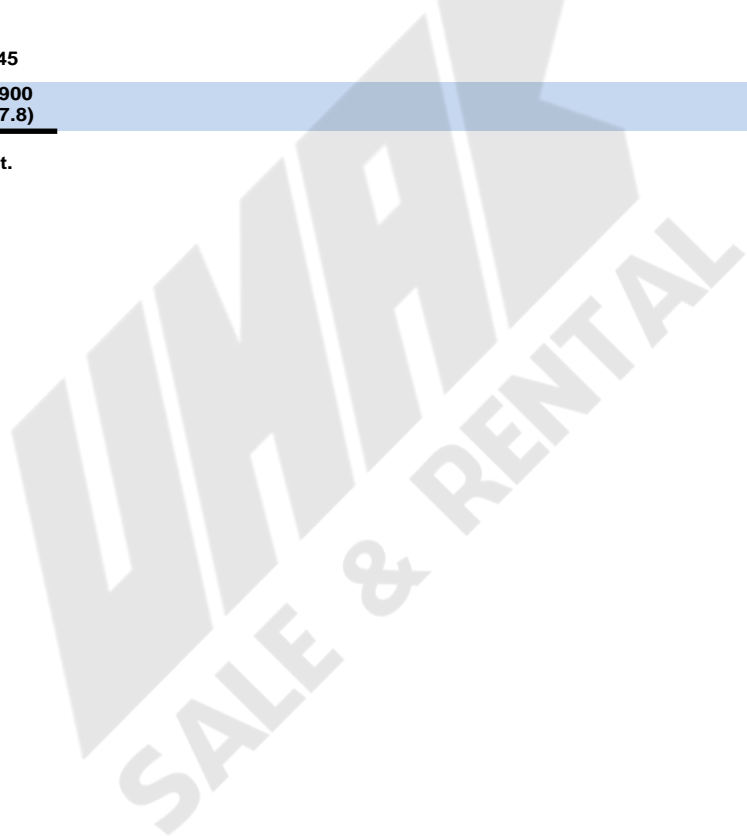



40 - 125 ft.
(12 - 38 m)



11,500 lbs.
(5216 kg)



33.25 R29
XRB** Tires
Stationary



Defined Arc
Over Front
±6°



Feet	40	45	55	65	75	85	95
10	80,350 (70.5)	75,800 (73)	53,800 (76.5)				
12	73,700 (67.5)	69,650 (70.5)	50,100 (74.5)	39,800 (77)			
15	64,300 (62.5)	60,850 (66)	44,900 (71)	35,550 (74.5)	29,500 (77)		
20	50,000 (53.5)	47,150 (58.5)	36,950 (65)	29,500 (69.5)	26,050 (72.5)	24,850 (75)	20,150 (77)
25	32,400 (42.5)	31,700 (50)	29,750 (59)	24,400 (64.5)	22,650 (68.5)	21,250 (71.5)	20,150 (74)
30	22,450 (28)	22,100 (40)	21,400 (52)	20,150 (59.5)	19,200 (64)	18,200 (68)	17,350 (70.5)
35		16,150 (26.5)	15,750 (44.5)	15,500 (54)	15,800 (59.5)	15,250 (64)	14,550 (67.5)
40			11,750 (35.5)	11,550 (47.5)	12,150 (55)	12,400 (60)	11,800 (64)
45			8,870 (23.5)	8,650 (41)	9,200 (50)	9,080 (56)	9,040 (60.5)
50				6,410 (32.5)	6,930 (44)	7,210 (51.5)	6,920 (56.5)
60					3,690 (30)	4,210 (41.5)	3,920 (48.5)
70						1,900 (28.5)	1,620 (39.5)

NOTE: () Boom angles are in degrees.

A6-829-011803B

Boom Angle	40	45	55	65	75
0°	19,200 (32.3)	13,750 (37.8)	7,570 (47.8)	3,810 (57.8)	2,040 (67.8)

NOTE: () Reference radii are in feet.

A6-829-011934A

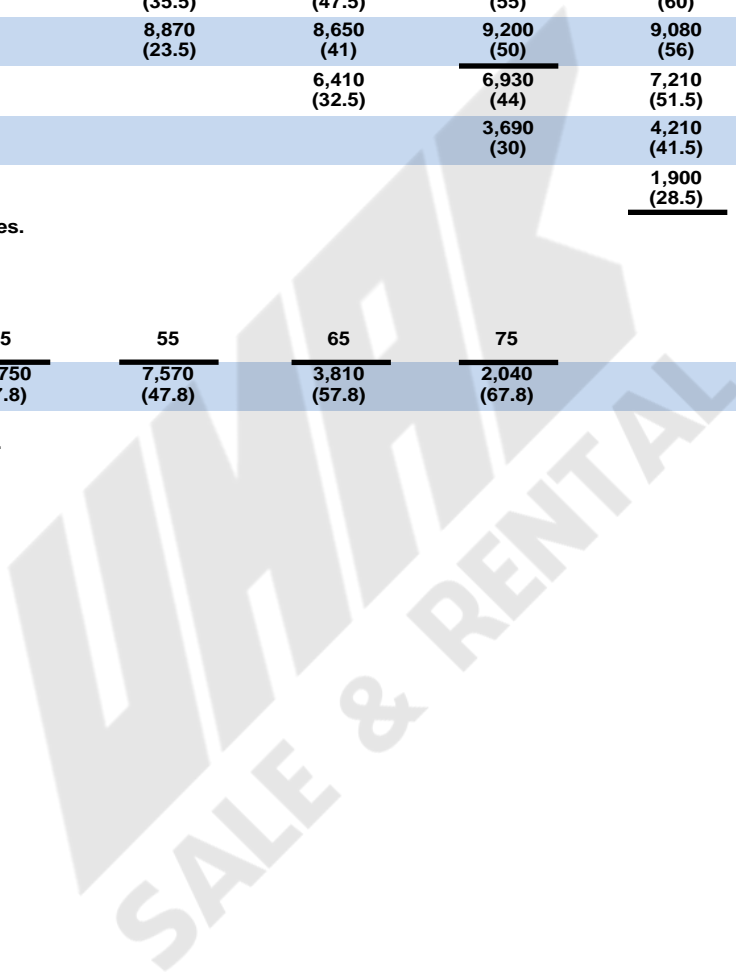



40 - 125 ft.
(12 - 38 m)



11,500 lbs.
(5216 kg)



33.25 R29
XRB** Tires
Pick & Carry
Up to 2.5 MPH



Boom Centered
Over Front



Feet	40	45	55	65	75	85	95
10	91,050 (70.5)	86,050 (73)	76,850 (76.5)				
12	81,900 (67.5)	77,550 (70.5)	69,550 (74.5)				
15	70,950 (62.5)	68,050 (66)	62,300 (71)	50,050 (74.5)	35,750 (77)		
20	50,000 (53.5)	48,650 (58.5)	46,050 (65)	43,350 (69.5)	31,900 (72.5)	31,600 (75)	
25	32,400 (42.5)	31,700 (50)	30,300 (59)	30,050 (64.5)	28,050 (68.5)	27,750 (71.5)	27,500 (74)
30	22,450 (28)	22,100 (40)	21,400 (52)	21,200 (59.5)	21,900 (64)	23,000 (68)	24,050 (70.5)
35		16,150 (26.5)	15,750 (44.5)	15,500 (54)	16,150 (59.5)	17,150 (64)	18,150 (67.5)
40			11,750 (35.5)	11,550 (47.5)	12,150 (55)	13,050 (60)	14,000 (64)
45			8,870 (23.5)	8,650 (41)	9,200 (50)	10,050 (56)	10,950 (60.5)
50				6,410 (32.5)	6,930 (44)	7,770 (51.5)	8,600 (56.5)
60					3,690 (30)	4,460 (41.5)	5,240 (48.5)
70						2,290 (28.5)	2,940 (39.5)
80							1,270 (27)

NOTE: () Boom angles are in degrees.

A6-829-011805B

Boom Angle	40	45	55	65	75	85
0°	19,200 (32.3)	13,750 (37.8)	7,570 (47.8)	3,810 (57.8)	2,040 (67.8)	1,020 (77.8)

NOTE: () Reference radii are in feet.

A6-829-011934A

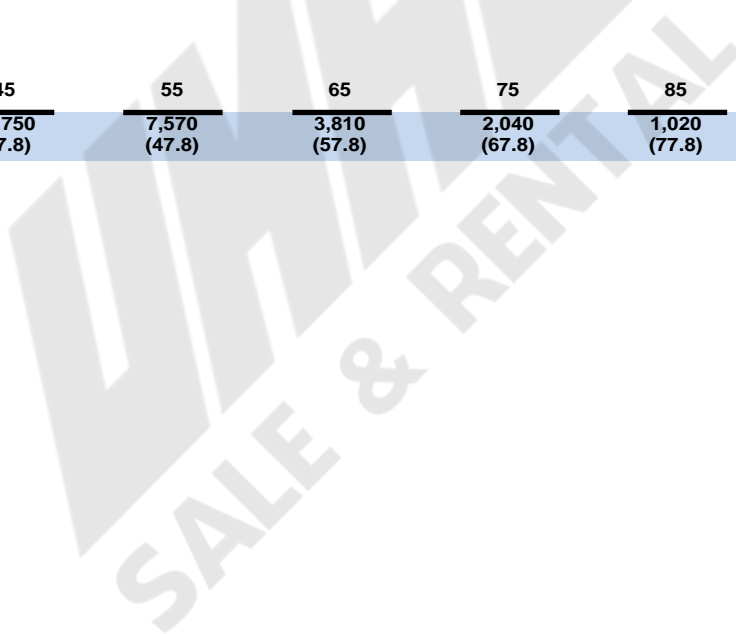

WEIGHT REDUCTIONS FOR LOAD HANDLING DEVICES

35 FT. BOOM EXTENSION	
*Stowed -	767 lbs.
*Erected -	4,823 lbs.
35 - 60 FT. TELE. BOOM EXTENSION	
*Stowed -	1,033 lbs.
*Erected (Retracted) -	6,499 lbs.
*Erected (Extended) -	8,740 lbs.

*Reduction of main boom capacities

AUXILIARY BOOM HEAD	112 lbs.
HOOKBLOCKS and HEADACHE BALLS:	
70 Ton, 6 Sheave w/cheekplates	2,010 lbs.+
70 Ton, 6 Sheave w/o cheekplates	1,674 lbs.+
15 Ton, 1 Sheave	420 lbs.+
10 Ton Headache Ball	560 lbs.+

+Refer to rating plate for actual weight.

Rated lifting capacities

NOTES FOR LIFTING CAPACITIES

WARNING: THIS CHART IS ONLY A GUIDE.

The notes below are for illustration only and should not be relied upon to operate the crane. The individual crane's load chart, operating instructions and other instruction plates must be read and understood prior to operating the crane.

1. All rated loads meet ANSI/ASME B30.5, Mobile and Locomotive Cranes. Testing and development were performed to SAEJ1063, Cantilevered Boom Crane Structures - Method of Test, and SAEJ765 Crane Stability Test Code.
2. Rated loads include the weight of hookblock, slings and auxiliary lifting devices and their weights shall be subtracted from the listed rating to obtain the net load to be lifted. When more than the minimum required hoist reeving is used, the additional rope weight shall be considered part of the load to be handled.
3. Capacities appearing above the bold line are based on structural strength. Tipping should not be relied upon as a capacity indication. The designated crane load chart indicates crane capacity.
4. The machine shall be leveled on a firm supporting surface. Depending on the nature of the supporting surface, it may be necessary to have structural supports under the outrigger floats or tires to spread the load to a larger bearing surface.
5. When either boom length or radius or both are between values listed, the smallest load shown at either the next larger radius or next longer or shorter boom length shall be used.
6. Tires shall be inflated to the recommended pressure before lifting on rubber.
7. For outrigger operation, outriggers shall be properly extended with tires raised free of crane weight before operating the boom or lifting loads.

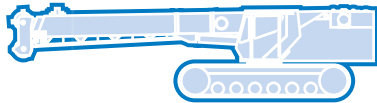
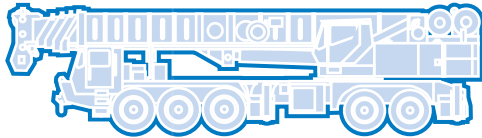
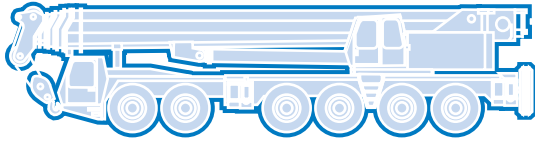
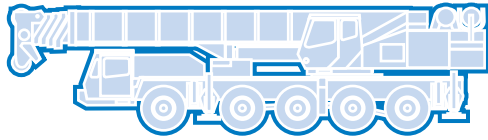

Grove Worldwide – World Headquarters

Grove North America
1565 Buchanan Trail East
P.O. Box 21
Shady Grove, Pennsylvania 17256, U.S.A.
Tel: [Int + 1] (717) 597-8121
Fax: [Int + 1] (717) 597-4062
Western Hemisphere, Asia/Pacific

Grove Europe Limited*
Sunderland SR4 6TT, England
Tel: [Int + 44] 191 565-6281
Fax: [Int + 44] 191 564-0442
Europe, Africa, Middle East

Grove Europe Limited*
P.O. Box No. 268
4A Kimber Road
Abingdon, Oxfordshire, OX141SG
Tel: [Int + 44] 1235 55-3184
Fax: [Int + 44] 1235 55-3218
*Grove Europe Limited, Registered in England,
Number 1845128, Registered office, Crown Works,
Pallion, Sunderland, Tyne & Wear, England SR4 6TT

Deutsche Grove GmbH
Sales and Service
Helmholtzstrasse 12, Postfach 5026
D-40750 Langenfeld, Germany
Tel: [Int + 49] (2173) 8909-0
Fax: [Int + 49] (2173) 8909-30

Wilhelmshaven Works
Industriegelände West, Postfach 1853
D-26358 Wilhelmshaven, Germany
Tel: [Int + 49] (4421) 294-0
Fax: [Int + 49] (4421) 294-301

Grove France S.A.

16, chaussée Jules-César, 95520 OSNY
B.P. 203, 95523 CERGY PONTOISE CEDEX
France
Tel: [Int + 33] (1) 30313150
Int: [Int + 33] (1) 30386085

Grove Asia/Pacific - Regional Office

171 Chin Swee Road
#06-01 San Centre
Singapore 0316
Tel: [Int + 65] 536-6112
Fax: [Int + 65] 536-6119
Asia/Pacific, Near East

Grove China - Representative Office

Beijing Suite 6074
No. 33 East Chang An Avenue
Beijing, 100004, China
Tel: [Int + 86] (10) 513-7766
Fax: [Int + 86] (10) 513-7307

Grove Product Support

Western Hemisphere, Asia/Pacific
1086 Wayne Avenue
Chambersburg, Pennsylvania USA
Tel: [Int + 1] (717) 263-5100
Fax: [Int + 1] (717) 267-0404

Europe, Africa, Middle East
Sunderland SR4 6TT, England
Tel: [Int + 44] 191 565-6281
Parts Fax: [Int + 44] 191 510-9242
Service Fax: [Int + 44] 191 510-9560

<http://www.groveworldwide.com>

Constant improvement and engineering progress make it necessary that we reserve the right to make specification, equipment, and price changes without notice. Illustrations shown may include optional equipment and accessories and may not include all standard equipment.

Distributed By: