

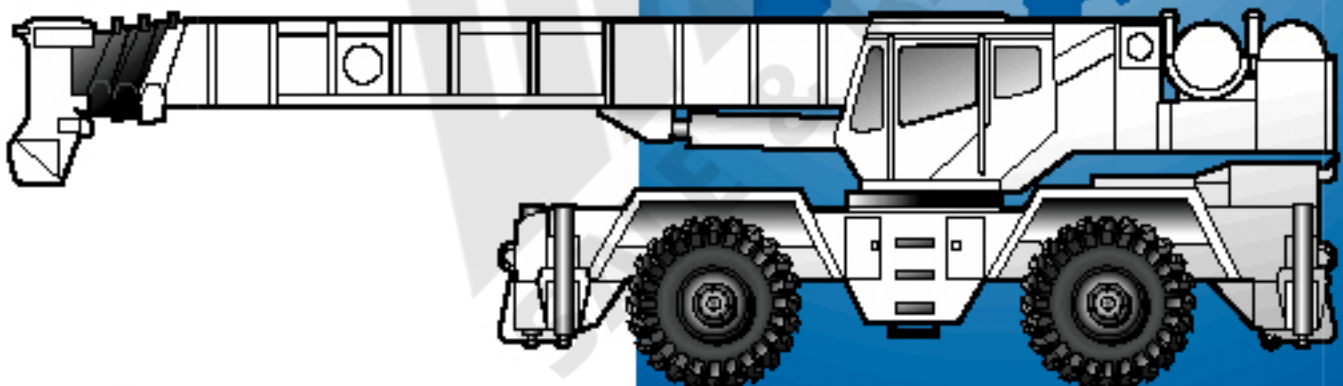

**GROVE**  
**CRANE**

# RT860



**Rough Terrain Hydraulic Crane**

# Dimensions

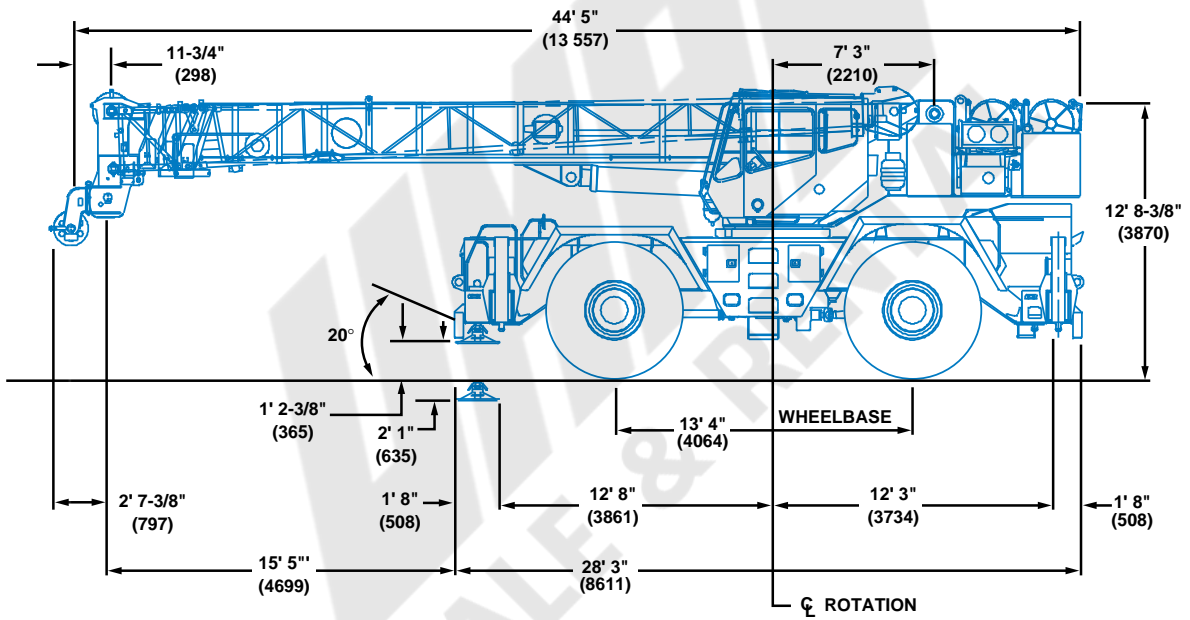
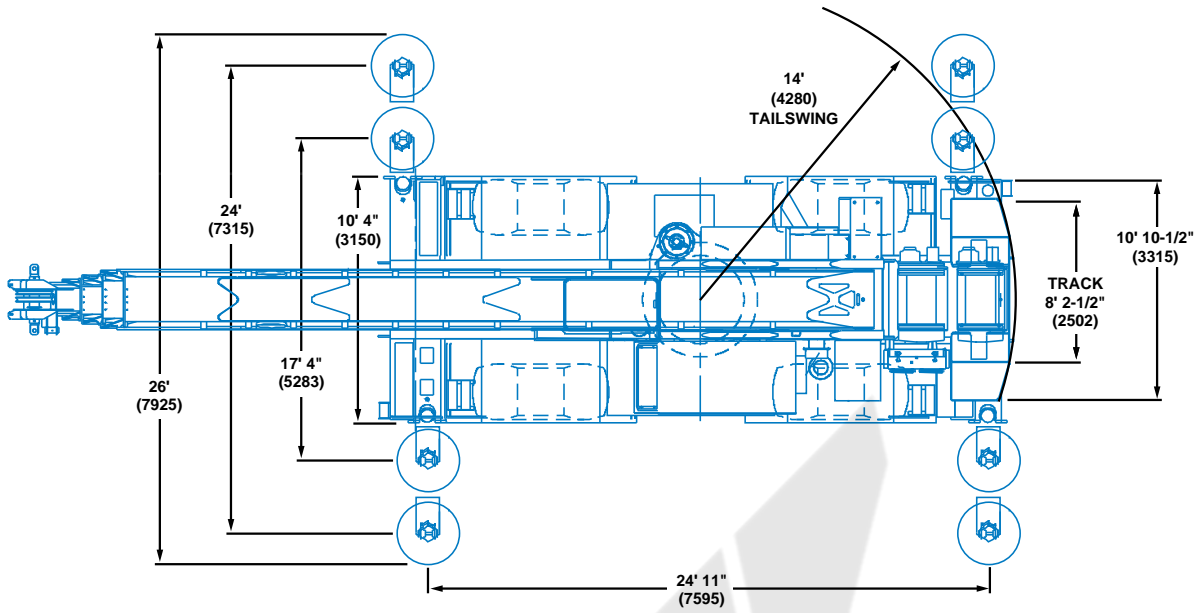

Note: ( ) Reference dimensions in mm

**Turning Radius** . . . . . 20' 7" (6274 mm)

**Front Axle Load** . . . . . 48,443 lbs. (21 974 kg)

**Rear Axle Load** . . . . . 46,326 lbs. (21 013 kg)

**Gross Vehicle Weight** . . . . . 94,769 lbs. (42 987 kg)

# Working Range



37 - 115 ft.  
(11.2 - 35.0 m)

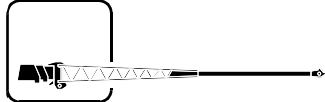

35 - 60 ft.  
(10.6 - 18.2 m)



9,500 lbs.  
(4309 kg)

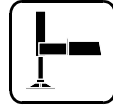

360°

FEET

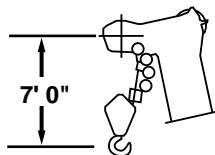
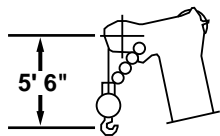
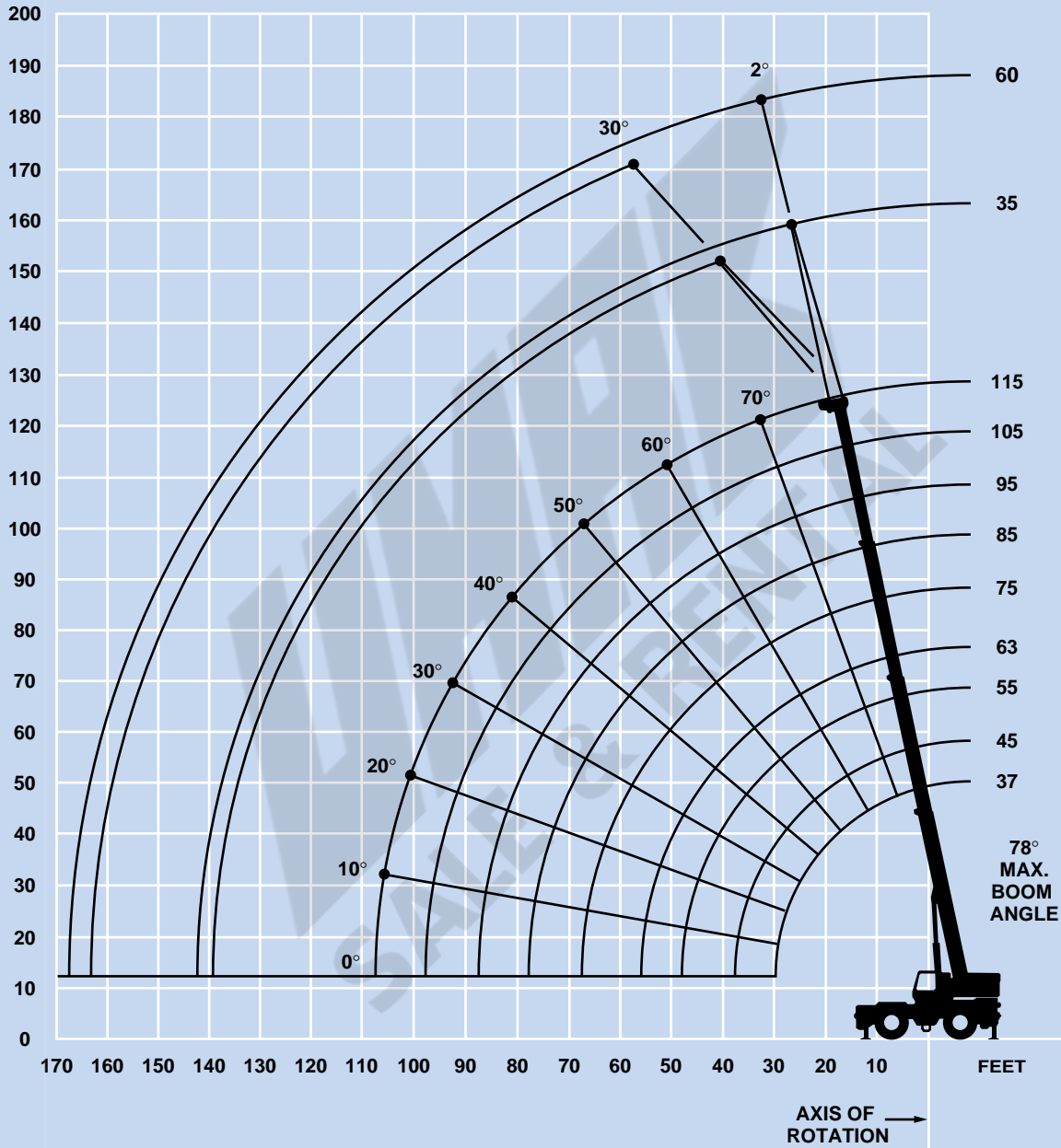

**DIMENSIONS ARE FOR LARGEST GROVE FURNISHED HOOK BLOCK AND HEADACHE BALL, WITH ANTI-TWO BLOCK ACTIVATED.**

# Carrier specifications

## Chassis

Box section frame fabricated from high-strength, low alloy steel. Integral outrigger housings and front/rear towing and tie down lugs.

## Outrigger System

Four hydraulic telescoping single-stage double box beam outriggers with inverted jacks and integral holding valves. Three position setting. All steel fabricated quick release type outrigger floats, 24" (610 mm) diameter.

Maximum outrigger pad load:

115 ft. boom: 92,575 lbs. (41 992 kg).

89 ft. boom - 82,400 lbs. (37 376 kg).

## Outrigger Controls

Controls and crane level indicator located in cab.

## Engine

Cummins 6CTA 8.3 diesel, six cylinders, turbocharged, 250 bhp (186 kW) (Gross) @ 2,200 RPM.

Maximum torque: 794 ft. lbs. (1077 Nm) @ 1,800 RPM.

## \*Optional Engine

Caterpillar 3126TA diesel, six cylinders, turbocharged, 250 bhp (186 kW (Gross) @ 2,500 RPM.

Maximum torque: 686 ft. lbs. (930 Nm) @ 1,600 RPM.

## Fuel Tank Capacity

80 gallons (303 L)

## Transmission

Full powershift with 6 forward and 6 reverse speeds.

Rear axle disconnect for 4 x 2 travel.

## Electrical System

Two 12 V - maintenance free batteries. 24 V starting and lighting.

## Drive

4 x 4.

## Steering

Fully independent power steering:

Front: Full hydraulic steering wheel controlled.

Rear: Full hydraulic hand lever controlled.

Provides infinite variations of 4 main steering modes: front only, rear only, crab and coordinated.

Rear steer indicating gauge.

## Axles

Front: Drive steer with differential and planetary reduction hubs rigid mounted to frame.

Rear: Drive/steer with differential and planetary reduction hubs pivot mounted to frame.

Automatic full hydraulic lockouts on rear axle.

## Oscillation Lockouts

Automatic full hydraulic lockouts on rear axle permits oscillation only with boom centered over the front.

## Brakes

Full air split circuit operating on all wheels. Spring-applied, air released front and rear axles.

## Tires

Std.: 29.5x25 - 28PR earthmover type.

\*Optional: 29.5R25 radial.

## Lights

Full lighting including turn indicators, head, tail, brake, and hazard warning lights.

## Maximum Speed

25 MPH (40 kph).

## Gradeability (Theoretical)

80% (Based on 92,667 lbs. [42 033 kg] GVW) 29.5x25 tires, pumps disengaged, 115 ft. (35 m) boom, plus 35 ft. (10.6 m) swingaway.

## Miscellaneous Standard Equipment

Full width steel fenders, dual rear view mirrors, hook-block tiedown, electronic back-up alarm, light package, front stowage well, tachometer/hourmeter, cold start aid (less canister), rear wheel position indicator, hydraulic cab heater, hoist mirrors, engine distress A/V warning system, tire inflation kit.

## \*Optional Equipment

- |  |  |
|--|--|
| *Boom mounted worklights   | *Dual axis joystick controllers          |
| *360° flashing light   | *Air conditioning                        |
| *Cab spotlights remote mounted   | *Auxiliary oil cooler                    |
| *Engine block heater   | *Emergency steer pump                    |
| *Hookblocks (quick reeving type)   | *Propane heater                          |
| *Tow winch - front mounted maximum pull: 15,000 lbs. (6804 kg); maximum speed: 92 ft/min. (28m/min). | *T/T lube system                         |
| *Spare tire & wheel assembly   | *Hoist mounted work light                |
| *Tool kit  | *Counterweight removal system            |
| *Pintle hook front/rear  | *3rd wrap indicators (main or auxiliary) |
| *High Speed Glide system   | *LMI light bar                           |
|  | *Cross axle differential locks           |
|  | *Oscillation lockout override control    |

*\*Denotes optional equipment*



37 - 115 ft.  
(11.2 - 35 m)



9,500 lbs.  
(4309 kg)



100%



360°



(Pounds)

(Feet)	37	45	55	*63	75	85	95	105	115
10	+120,000 (69)	86,600 (73)	75,550 (76.5)						
12	97,800 (65.5)	86,600 (70.5)	75,550 (74.5)	60,950 (76.5)					
15	86,500 (59.5)	81,050 (66)	75,550 (71)	60,950 (73.5)	44,100 (77)				
20	68,950 (49.5)	67,500 (58.5)	64,000 (65)	58,950 (68.5)	44,100 (73)	43,450 (75.5)	40,400 (77.5)		
25	54,900 (36.5)	54,200 (50)	53,400 (59)	49,100 (63.5)	40,200 (68.5)	36,750 (71.5)	34,350 (74)	30,600 (76)	@24,450 (78)
30		41,950 (40)	41,400 (52)	41,050 (58)	34,800 (64.5)	31,650 (68)	29,450 (71)	27,350 (73.5)	22,200 (75.5)
35		33,550 (26)	33,000 (44.5)	32,700 (52)	30,550 (60)	27,650 (64)	25,700 (67.5)	24,250 (70.5)	19,900 (72.5)
40			26,900 (35.5)	26,600 (46)	27,100 (55)	24,500 (60.5)	22,650 (64)	21,300 (67.5)	17,800 (70)
45			21,100 (23.5)	20,850 (38.5)	22,200 (50)	21,850 (56)	20,150 (60.5)	18,900 (64.5)	16,000 (67)
50				16,550 (29)	17,850 (44.5)	18,950 (51.5)	18,050 (57)	16,900 (61)	14,550 (64.5)
55				13,250 (13.5)	14,550 (38)	15,600 (47)	16,250 (53)	15,200 (57.5)	13,250 (61.5)
60					12,000 (30.5)	12,950 (42)	13,550 (49)	13,750 (54.5)	12,300 (58.5)
65					9,940 (20)	10,800 (36)	11,400 (44.5)	11,950 (50.5)	11,350 (55.5)
70						9,050 (29)	9,620 (39.5)	10,150 (46.5)	10,450 (52)
75						7,560 (19)	8,100 (34)	8,650 (42.5)	9,200 (48.5)
80							6,840 (27.5)	7,360 (38)	7,890 (45)
85							5,780 (18)	6,270 (32.5)	6,760 (41)
90								5,310 (26.5)	5,770 (36.5)
95								4,470 (17.5)	4,900 (31.5)
100									4,130 (25.5)
105									3,440 (17)

Minimum boom angle (deg.) for indicated length (no load)

115

Maximum boom length (ft.) at 0 deg. boom angle (no load)

0

NOTE: ( ) Boom angles are in degrees.

\*63 ft. boom length is with inner-mid extended and outer-mid and fly retracted.

+10 parts of line required to lift this capacity (using aux. boom nose).

@This capacity is based on maximum boom angle.

A6-829-015496A

Boom Angle	37	45	55	*63	75	85	95	105	115
0°	24,400 (29.8)	17,750 (37.8)	12,200 (47.8)	9,000 (55.8)	6,820 (67.8)	5,470 (77.8)	4,400 (87.8)	3,540 (97.8)	2,820 (107.8)

A6-829-012234



37 - 115 ft.  
(11.2 - 35 m)



0 lbs.  
(0kg)



100%



360°



(Pounds)

(Feet)	37	45	55	*63	75	85	95	105	115
10	+120,000 (69)	86,600 (73)	75,550 (76.5)						
12	97,800 (65.5)	86,600 (70.5)	75,550 (74.5)	60,950 (76.5)					
15	86,500 (59.5)	81,050 (66)	75,550 (71)	60,950 (73.5)	44,100 (77)				
20	64,250 (49.5)	64,250 (58.5)	64,000 (65)	58,950 (68.5)	44,100 (73)	43,450 (75.5)	40,400 (77.5)		
25	48,150 (36.5)	47,450 (50)	46,800 (59)	46,400 (63.5)	40,200 (68.5)	36,750 (71.5)	34,350 (74)	30,600 (76)	@24,450 (78)
30		36,450 (40)	35,850 (52)	35,500 (58)	34,800 (64.5)	31,650 (68)	29,450 (71)	27,350 (73.5)	22,200 (75.5)
35		27,450 (26)	27,100 (44.5)	26,850 (52)	28,050 (60)	27,650 (64)	25,700 (67.5)	24,250 (70.5)	19,900 (72.5)
40			20,150 (35.5)	19,950 (46)	21,150 (55)	22,150 (60.5)	22,650 (64)	21,300 (67.5)	17,800 (70)
45			15,300 (23.5)	15,100 (38.5)	16,350 (50)	17,350 (56)	17,950 (60.5)	18,550 (64.5)	16,000 (67)
50				11,550 (29)	12,800 (44.5)	13,800 (51.5)	14,400 (57)	14,950 (61)	14,550 (64.5)
55				8,870 (13.5)	10,100 (38)	11,100 (47)	11,650 (53)	12,200 (57.5)	12,750 (61.5)
60					8,040 (30.5)	8,970 (42)	9,500 (49)	10,000 (54.5)	10,550 (58.5)
65					6,380 (20)	7,220 (36)	7,740 (44.5)	8,260 (50.5)	8,780 (55.5)
70						5,780 (29)	6,290 (39.5)	6,800 (46.5)	7,310 (52)
75						4,550 (19)	5,060 (34)	5,560 (42.5)	6,060 (48.5)
80							4,020 (27.5)	4,500 (38)	4,990 (45)
85							3,160 (18)	3,610 (32.5)	4,060 (41)
90								2,830 (26.5)	3,250 (36.5)
95								2,140 (17.5)	2,540 (31.5)
100									1,910 (25.5)
105									1,350 (17)

Minimum boom angle (deg.) for indicated length (no load)

115

Maximum boom length (ft.) at 0 deg. boom angle (no load)

0

NOTE: ( ) Boom angles are in degrees.

\*63 ft. boom length is with inner-mid extended and outer-mid and fly retracted.

+10 parts of line required to lift this capacity (using aux. boom nose).

@This capacity is based on maximum boom angle.

A6-829-015494A

Boom Angle	37	45	55	*63	75	85	95	105	115
0°	24,400 (29.8)	17,750 (37.8)	12,200 (47.8)	8,520 (55.8)	5,590 (67.8)	3,950 (77.8)	2,730 (87.8)	1,800 (97.8)	1,070 (107.8)

A6-829-012168



37 - 115 ft.  
(11.2 - 35 m)



9,500 lbs.  
(4309 kg)



50%



360°



(Pounds)

(Feet)	37	45	55	*63	75	85	95	105	115
10	+110,000 (69)	86,600 (73)	75,550 (76.5)						
12	97,800 (65.5)	86,600 (70.5)	75,550 (74.5)	60,950 (76.5)					
15	86,500 (59.5)	81,050 (66)	75,550 (71)	60,950 (73.5)	44,100 (77)				
20	60,750 (49.5)	56,900 (58.5)	53,200 (65)	50,650 (68.5)	44,100 (73)	43,450 (75.5)	40,400 (77.5)		
25	41,400 (36.5)	39,350 (50)	36,850 (59)	35,250 (63.5)	35,450 (68.5)	35,300 (71.5)	34,350 (74)	30,600 (76)	@24,450 (78)
30		28,750 (40)	27,150 (52)	25,900 (58)	26,550 (64.5)	26,700 (68)	26,750 (71)	26,650 (73.5)	22,200 (75.5)
35		21,150 (26)	20,700 (44.5)	19,700 (52)	20,500 (60)	20,850 (64)	21,050 (67.5)	21,150 (70.5)	19,900 (72.5)
40			15,850 (35.5)	15,200 (46)	16,150 (55)	16,650 (60.5)	16,950 (64)	17,100 (67.5)	17,200 (70)
45			12,100 (23.5)	11,900 (38.5)	12,900 (50)	13,400 (56)	13,800 (60.5)	14,000 (64.5)	14,200 (67)
50				9,210 (29)	10,300 (44.5)	10,900 (51.5)	11,300 (57)	11,600 (61)	11,800 (64.5)
55				6,990 (13.5)	8,150 (38)	8,890 (47)	9,320 (53)	9,640 (57.5)	9,870 (61.5)
60					6,390 (30.5)	7,220 (42)	7,680 (49)	8,020 (54.5)	8,270 (58.5)
65					4,950 (20)	5,760 (36)	6,290 (44.5)	6,660 (50.5)	6,930 (55.5)
70						4,490 (29)	5,000 (39.5)	5,500 (46.5)	5,780 (52)
75						3,410 (19)	3,920 (34)	4,420 (42.5)	4,790 (48.5)
80							3,000 (27.5)	3,480 (38)	3,930 (45)
85							2,230 (18)	2,690 (32.5)	3,140 (41)
90								1,980 (26.5)	2,410 (36.5)
95								1,360 (17.5)	1,760 (31.5)
100									1,190 (25.5)
Minimum boom angle (deg.) for indicated length (no load)									11.5
Maximum boom length (ft.) at 0 deg. boom angle (no load)									105

NOTE: ( ) Boom angles are in degrees.

\*63 ft. boom length is with inner-mid extended and outer-mid and fly retracted.

+9 parts of line required to lift this capacity (using auxiliary boom nose).

@ This capacity is based on maximum boom angle.

A6-829-011791C

Boom Angle	37	45	55	*63	75	85	95	105
0°	24,400 (29.8)	17,750 (37.8)	10,450 (47.8)	6,700 (55.8)	4,260 (67.8)	2,880 (77.8)	1,850 (87.8)	1,050 (97.8)

A6-829-012234



37 - 115 ft.  
(11.2 - 35 m)



0 lbs.  
(0 kg)



50%



360°



(Pounds)

(Feet)	37	45	55	*63	75	85	95	105	115
10	+110,000 (69)	86,600 (73)	75,550 (76.5)						
12	97,800 (65.5)	86,600 (70.5)	75,550 (74.5)	60,950 (76.5)					
15	77,900 (59.5)	71,850 (66)	65,800 (71)	60,950 (73.5)	44,100 (77)				
20	46,050 (49.5)	42,800 (58.5)	39,700 (65)	37,600 (68.5)	37,500 (73)	37,050 (75.5)	36,450 (77.5)		
25	31,200 (36.5)	28,900 (50)	26,750 (59)	25,350 (63.5)	25,900 (68.5)	26,050 (71.5)	26,000 (74)	25,800 (76)	@24,450 (78)
30		20,700 (40)	19,050 (52)	18,000 (58)	18,850 (64.5)	19,200 (68)	19,400 (71)	19,450 (73.5)	19,400 (75.5)
35		14,900 (26)	13,900 (44.5)	13,050 (52)	14,050 (60)	14,550 (64)	14,850 (67.5)	15,050 (70.5)	15,100 (72.5)
40			10,250 (35.5)	9,520 (46)	10,600 (55)	11,150 (60.5)	11,550 (64)	11,800 (67.5)	12,000 (70)
45			7,540 (23.5)	6,860 (38.5)	7,990 (50)	8,610 (56)	9,050 (60.5)	9,360 (64.5)	9,580 (67)
50				4,800 (29)	5,950 (44.5)	6,590 (51.5)	7,070 (57)	7,410 (61)	7,670 (64.5)
55				3,200 (13.5)	4,310 (38)	4,980 (47)	5,470 (53)	5,840 (57.5)	6,120 (61.5)
60					2,980 (30.5)	3,650 (42)	4,150 (49)	4,540 (54.5)	4,840 (58.5)
65					1,880 (20)	2,540 (36)	3,050 (44.5)	3,450 (50.5)	3,760 (55.5)
70						1,600 (29)	2,120 (39.5)	2,520 (46.5)	2,940 (52)
75							1,320 (34)	1,720 (42.5)	2,050 (48.5)
80								1,030 (38)	1,360 (45)
Minimum boom angle (deg.) for indicated length (no load)									11.5
Maximum boom length (ft.) at 0 deg. boom angle (no load)									105

NOTE: ( ) Boom angles are in degrees.

\*63 ft. boom length is with inner-mid extended and outer-mid and fly retracted.

+9 parts of line required to lift this capacity (using auxiliary boom nose).

@This capacity is based on maximum boom angle.

A6-829-012154A

Boom Angle	37	45	55	*63	75
0°	21,850 (29.8)	12,550 (37.8)	6,290 (47.8)	3,080 (55.8)	1,450 (67.8)

A6-829-012168





37 - 115 ft.  
(11.2 - 35 m)



9,500 lbs.  
(4309 kg)



0%



360°



(Pounds)

(Feet)	37	45	55	*63	75	85	95	105	115
10	82,900 (69)	76,200 (73)	69,350 (76.5)						
12	63,000 (65.5)	58,400 (70.5)	53,700 (74.5)	50,500 (76.5)					
15	45,250 (59.5)	42,150 (66)	39,000 (71)	36,900 (73.5)	36,450 (77)				
20	28,150 (49.5)	27,200 (58.5)	25,200 (65)	23,900 (68.5)	24,250 (73)	24,300 (75.5)	24,150 (77.5)		
25	18,300 (36.5)	17,900 (50)	17,350 (59)	16,350 (63.5)	17,100 (68.5)	17,400 (71.5)	17,500 (74)	17,500 (76)	@ 17,450 (78)
30		12,200 (40)	11,900 (52)	11,400 (58)	12,350 (64.5)	12,800 (68)	13,050 (71)	13,200 (73.5)	13,300 (75.5)
35		8,590 (26)	8,360 (44.5)	7,980 (52)	8,990 (60)	9,520 (64)	9,890 (67.5)	10,100 (70.5)	10,250 (72.5)
40			5,820 (35.5)	5,410 (46)	6,480 (55)	7,060 (60.5)	7,480 (64)	7,780 (67.5)	7,980 (70)
45			3,920 (23.5)	3,430 (38.5)	4,530 (50)	5,150 (56)	5,600 (60.5)	5,940 (64.5)	6,180 (67)
50				1,860 (29)	2,980 (44.5)	3,620 (51.5)	4,100 (57)	4,460 (61)	4,730 (64.5)
55					1,720 (38)	2,380 (47)	2,870 (53)	3,240 (57.5)	3,530 (61.5)
60						1,340 (42)	1,840 (49)	2,230 (54.5)	2,530 (58.5)
65								1,370 (50.5)	1,680 (55.5)

Minimum boom angle (deg.) for indicated length (no load)

52.5

Maximum boom length (ft.) at 0 deg. boom angle (no load)

55

NOTE: ( ) Boom angles are in degrees.

\*63 ft. boom length is with inner-mid extended and outer-mid and fly retracted.

@ This capacity is based on maximum boom angle.

A6-829-011902B

Boom Angle	37	45	55
0°	12,600 (29.8)	7,080 (37.8)	3,060 (47.8)

A6-829-012234



37 - 115 ft.  
(11.2 - 35 m)



0 lbs.  
(0 kg)



0%



360°



(Feet)	37	45	55	*63	75	85	95	105	115
10	60,400 (69)	55,000 (73)	49,600 (76.5)						
12	45,250 (65.5)	41,550 (70.5)	37,750 (74.5)	35,250 (76.5)					
15	31,750 (59.5)	29,200 (66)	26,650 (71)	24,950 (73.5)	25,050 (77)				
20	19,100 (49.5)	17,850 (58.5)	16,200 (65)	15,100 (68.5)	15,800 (73)	16,050 (75.5)	16,100 (77.5)		
25	11,700 (36.5)	11,500 (50)	10,200 (59)	9,400 (63.5)	10,300 (68.5)	10,800 (71.5)	11,050 (74)	11,200 (76)	@11,300 (78)
30		7,150 (40)	6,370 (52)	5,680 (58)	6,730 (64.5)	7,300 (68)	7,680 (71)	7,940 (73.5)	8,100 (75.5)
35		4,250 (26)	3,650 (44.5)	3,050 (52)	4,170 (60)	4,800 (64)	5,240 (67.5)	6,560 (70.5)	5,780 (72.5)
40			1,650 (35.5)	1,100 (46)	2,260 (55)	2,920 (60.5)	3,400 (64)	3,760 (67.5)	4,020 (70)
45						1,460 (56)	1,970 (60.5)	2,350 (64.5)	2,640 (67)
50								1,220 (61)	1,520 (64.5)

Minimum boom angle (deg.) for indicated length (no load)

52.5

Maximum boom length (ft.) at 0 deg. boom angle (no load)

55

NOTE: ( ) Boom angles are in degrees.

\*63 ft. boom length is with inner-mid extended and outer-mid and fly retracted.

@This capacity is based on maximum boom angle.

A6-829-012155A

Boom Angle	37	45
0°	7,470 (29.8)	3,020 (37.8)

A6-829-012168



37 - 115 ft.  
(11.2 - 35 m)



35 - 60 ft.  
(10.6 - 18.2 m)



9,500 lbs.  
(4309 kg)



100%



360°



(Pounds)

(Feet)	35 ft. LENGTH		60 ft. LENGTH	
	2° OFFSET	30° OFFSET	2° OFFSET	30° OFFSET
35	*12,900 (78)			
40	11,900 (75.5)		*6,700 (78)	
45	11,150 (73.5)		6,500 (77.5)	
50	10,450 (71.5)	7,500 (77)	6,400 (76)	
55	9,870 (69.5)	7,310 (74.5)	6,300 (74)	
60	9,340 (67.5)	7,150 (72.5)	6,200 (72.5)	
65	8,850 (65)	7,010 (70.5)	6,100 (70.5)	
70	8,420 (63)	6,880 (68)	6,000 (69)	4,000 (77)
75	8,020 (60.5)	6,760 (66)	5,670 (67)	3,680 (75)
80	7,660 (58.5)	6,650 (63.5)	5,340 (65)	3,500 (73.5)
85	7,330 (56)	6,560 (61)	5,010 (63.5)	3,350 (71.5)
90	6,490 (53.5)	6,470 (58.5)	4,680 (61.5)	3,280 (69.5)
95	5,550 (51)	5,550 (56)	4,350 (59.5)	3,220 (67)
100	4,720 (48.5)	4,720 (53)	4,000 (57.5)	3,160 (65)
105	3,980 (45.5)	3,980 (50)	3,670 (55)	3,100 (63)
110	3,310 (42.5)	3,310 (47)	3,340 (53)	3,050 (60.5)
115	2,710 (39.5)	2,710 (43.5)	3,070 (51)	3,000 (58)
120	2,170 (36)	2,170 (40)	2,950 (48.5)	2,960 (55.5)
125	1,670 (32.5)	1,670 (36)	2,840 (46)	2,930 (53)
130	1,220 (28)	1,220 (31)	2,730 (43.5)	2,730 (50.5)
135			2,280 (41)	2,280 (47.5)
140			1,860 (38)	1,860 (44.5)
145			1,470 (35)	1,470 (41)
150			1,110 (31.5)	1,110 (37)

NOTE: ( ) Boom angles are in degrees.

\*This capacity is based upon maximum boom angle.

A6-829-011795B



37 - 115 ft.  
(11.2 - 35 m)

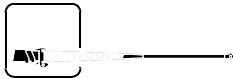

35 - 60 ft.  
(10.6 - 18.2 m)



0 lbs.  
(0 kg)



100%



360°



(Pounds)

(Feet)	35 ft. LENGTH		60 ft. LENGTH	
	2° OFFSET	30° OFFSET	2° OFFSET	30° OFFSET
35	*12,900 (78)			
40	11,900 (75.5)		*6,700 (78)	
45	11,150 (73.5)		6,270 (77.5)	
50	10,450 (71.5)	7,500 (77)	5,860 (76)	
55	9,870 (69.5)	7,310 (74.5)	5,510 (74)	
60	9,340 (67.5)	7,150 (72.5)	5,180 (72.5)	
65	8,850 (65)	7,010 (70.5)	4,900 (70.5)	
70	8,300 (63)	6,880 (68)	4,630 (69)	4,000 (77)
75	6,930 (60.5)	6,760 (66)	4,400 (67)	3,680 (75)
80	5,760 (58.5)	5,760 (63.5)	4,180 (65)	3,500 (73.5)
85	4,750 (56)	4,750 (61)	3,980 (63.5)	3,350 (71.5)
90	3,860 (53.5)	3,860 (58.5)	3,800 (61.5)	3,280 (69.5)
95	3,090 (51)	3,090 (56)	3,630 (59.5)	3,220 (67)
100	2,400 (48.5)	2,400 (53)	3,470 (57.5)	3,160 (65)
105	1,790 (45.5)	1,790 (50)	3,300 (55)	3,100 (63)
110	1,240 (42.5)	1,240 (47)	2,720 (53)	2,720 (60.5)
115			2,200 (51)	2,200 (58)
120			1,730 (48.5)	1,730 (55.5)
125			1,290 (46)	1,290 (53)

NOTE: ( ) Boom angles are in degrees.

\*This capacity is based upon maximum boom angle.

A6-829-012147



37 - 115 ft.  
(11.2 - 35 m)



35 - 60 ft.  
(10.6 - 18.2 m)



9,500 lbs.  
(4309 kg)



50%



360°



(Pounds)

(Feet)	35 ft. LENGTH		60 ft. LENGTH	
	2° OFFSET	30° OFFSET	2° OFFSET	30° OFFSET
35	*12,900 (78)			
40	11,900 (75.5)		*6,700 (78)	
45	11,150 (73.5)		6,270 (77.5)	
50	10,450 (71.5)	7,500 (77)	5,860 (76)	
55	9,150 (69.5)	7,310 (74.5)	5,510 (74)	
60	7,620 (67.5)	7,150 (72.5)	5,180 (72.5)	
65	6,330 (65)	6,330 (70.5)	4,900 (70.5)	
70	5,230 (63)	5,230 (68)	4,630 (69)	4,000 (77)
75	4,270 (60.5)	4,270 (66)	4,400 (67)	3,680 (75)
80	3,430 (58.5)	3,430 (63.5)	4,180 (65)	3,500 (73.5)
85	2,690 (56)	2,690 (61)	3,920 (63.5)	3,350 (71.5)
90	2,040 (53.5)	2,040 (58.5)	3,270 (61.5)	3,270 (69.5)
95	1,450 (51)	1,450 (56)	2,690 (59.5)	2,690 (67)
100			2,170 (57.5)	2,170 (65)
105			1,690 (55)	1,690 (63)
110			1,260 (53)	1,260 (60.5)

NOTE: ( ) Boom angles are in degrees.

\*This capacity is based upon maximum boom angle.

A6-829-011796D



37 - 115 ft.  
(11.2 - 35 m)

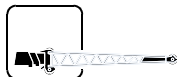

35 ft.  
(10.6 m)



9,500 lbs.  
(4309 kg)



100%



360°



(Pounds)

35 ft. LENGTH

(Feet)	2° OFFSET	30° OFFSET
35	*12,900 (78)	
40	12,200 (75.5)	
45	11,450 (73.5)	
50	10,750 (71.5)	7,800 (77)
55	10,150 (69.5)	7,610 (74.5)
60	9,640 (67.5)	7,450 (72.5)
65	9,150 (65)	7,310 (70.5)
70	8,720 (63)	7,180 (68)
75	8,320 (60.5)	7,060 (66)
80	7,960 (58.5)	6,950 (63.5)
85	7,630 (56)	6,860 (61)
90	6,970 (53.5)	6,770 (58.5)
95	6,040 (51)	6,040 (56)
100	5,210 (48.5)	5,210 (53)
105	4,470 (45.5)	4,470 (50)
110	3,800 (42.5)	3,800 (47)
115	3,200 (39.5)	3,200 (43.5)
120	2,660 (36)	2,660 (40)
125	2,160 (32.5)	2,160 (36)
130	1,710 (28)	
135	1,290 (23)	

NOTE: ( ) Boom angles are in degrees.

\*This capacity is based on maximum boom angle.

A6-829-012129A



37 - 115 ft.  
(11.2 - 35 m)

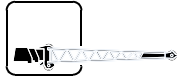

35 ft.  
(10.6 m)



0 lbs.  
(0 kg)



100%



360°



(Pounds)

35 ft. LENGTH

(Feet)	2° OFFSET	30° OFFSET
35	*12,900 (78)	
40	12,200 (75.5)	
45	11,450 (73.5)	
50	10,750 (71.5)	7,800 (77)
55	10,150 (69.5)	7,610 (74.5)
60	9,640 (67.5)	7,450 (72.5)
65	9,150 (65)	7,310 (70.5)
70	8,720 (63)	7,180 (68)
75	7,410 (60.5)	7,060 (66)
80	6,240 (58.5)	6,240 (63.5)
85	5,230 (56)	5,230 (61)
90	4,350 (53.5)	4,350 (58.5)
95	3,580 (51)	3,580 (56)
100	2,890 (48.5)	2,890 (53)
105	2,280 (45.5)	2,280 (50)
110	1,730 (42.5)	1,730 (47)
115	1,230 (39.5)	1,230 (43.5)

NOTE: ( ) Boom angles are in degrees.

\*This capacity is based on maximum boom angle.

A6-829-012129A

SALE & RENTAL



37 - 115 ft.  
(11.2 - 35 m)

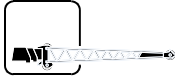

35 ft.  
(10.6 m)



9,500 lbs.  
(4309 kg)



50%



360°



(Pounds)

35 ft. LENGTH

(Feet)	2° OFFSET	30° OFFSET
35	*12,900 (78)	
40	12,200 (75.5)	
45	11,450 (73.5)	
50	10,750 (71.5)	7,800 (77)
55	9,720 (69.5)	7,610 (74.5)
60	8,190 (67.5)	7,450 (72.5)
65	6,900 (65)	6,900 (70.5)
70	5,800 (63)	5,800 (68)
75	4,840 (60.5)	4,840 (66)
80	4,010 (58.5)	4,010 (63.5)
85	3,270 (56)	3,270 (61)
90	2,620 (53.5)	2,620 (58.5)
95	2,030 (51)	2,030 (56)
100	1,510 (48.5)	1,510 (53)
105	1,030 (45.5)	1,030 (50)

NOTE: ( ) Boom angles are in degrees.

\*This capacity is based on maximum boom angle.

A6-829-012145C

SALE & RENTAL





37 - 115 ft.  
(11.2 - 35.0 m)



9,500 lbs.  
(4309 kg)



Stationary  
29.5 x 25 - 28PR Tires



Defined Arc  
Over Front  
±6°



(Pounds)

(Feet)	37	45	55	*63	75	85	95
10	44,100 (68.5)	39,100 (73)					
12	44,100 (65)	39,100 (70)	29,950 (74)	23,800 (76.5)			
15	42,800 (59.5)	39,100 (65.5)	29,950 (70.5)	23,800 (73.5)	19,400 (76.5)		
20	34,100 (49)	30,000 (58)	27,600 (65)	23,800 (68.5)	19,400 (72.5)	15,950 (75)	
25	26,100 (36)	23,500 (49.5)	22,250 (58.5)	19,900 (63.5)	19,400 (68)	15,950 (71)	15,500 (73.5)
30		18,650 (39.5)	17,850 (52)	16,450 (58)	15,750 (64)	14,750 (67.5)	13,750 (70.5)
35		13,650 (26)	13,300 (44.5)	13,000 (52)	12,750 (59.5)	12,400 (64)	12,050 (67)
40			9,920 (35.5)	9,650 (45.5)	10,200 (54.5)	10,250 (60)	10,350 (63.5)
45			7,420 (23)	7,190 (38)	8,000 (49.5)	8,370 (55.5)	8,750 (60)
50				5,300 (29)	6,100 (44)	6,640 (51)	7,180 (56.5)
55				3,810 (13.5)	4,430 (37.5)	4,940 (46.5)	5,650 (52.5)
60					2,960 (30)	3,560 (41.5)	4,170 (48.5)
65					1,650 (19.5)	2,190 (35.5)	2,740 (44)
70							1,340 (39)

NOTE: ( ) Boom angles are in degrees.

\*63 ft. boom length is with inner-mid extended and outer-mid and fly retracted.

A6-829-012231A

Boom Angle	37	45	55	*63
0°	19,300 (29.8)	11,650 (37.8)	6,310 (47.8)	3,610 (55.8)

A6-829-012234



37 -115 ft.  
(11.2 - 35 m)



9,500 lbs.  
(4309 kg)



Stationary  
29.5 x 25 - 28PR Tires



360°



(Pounds)

(Feet)	37	45	55	*63	75	85	95
10	33,250 (68.5)	31,400 (73)					
12	29,100 (65)	27,450 (70)	25,850 (74)				
15	23,700 (59.5)	22,350 (65.5)	21,650 (70.5)				
20	16,550 (49)	15,550 (58)	15,200 (65)	14,950 (68.5)	13,150 (72.5)	12,050 (75)	
25	10,900 (36)	10,800 (49.5)	10,600 (58.5)	10,500 (63.5)	9,600 (68)	9,990 (71)	9,110 (73.5)
30		7,560 (39.5)	7,120 (52)	6,780 (58)	7,000 (64)	8,030 (67.5)	9,110 (70.5)
35		5,000 (26)	4,700 (44.5)	4,460 (52)	5,000 (59.5)	6,170 (64)	6,650 (67)
40			2,620 (35.5)	2,310 (45.5)	3,410 (54.5)	4,410 (60)	4,650 (63.5)
45					2,120 (49.5)	2,730 (55.5)	3,010 (60)
50					1,050 (44)	1,130 (51)	1,590 (56.5)

NOTE: ( ) Boom angles are in degrees.

\*63 ft. boom length is with inner-mid extended and outer-mid and fly retracted.

A6-829-012232A

Boom Angle	37	45
0°	8,320 (29.8)	3,840 (37.8)

A6-829-012234



37 - 115 ft.  
(11.2 - 35 m)



9,500 lbs.  
(4309 kg)



Pick & Carry  
Up to 2.5 MPH  
29.5 x 25 - 28PR Tires



Boom Centered Over Front



(Pounds)

(Feet)	37	45	55	*63	75	85	95
10	47,050 (68.5)	32,100 (73)					
12	43,800 (65)	32,100 (70)	28,150 (74)	25,000 (76.5)			
15	39,200 (59.5)	32,100 (65.5)	28,150 (70.5)	25,000 (73.5)	19,650 (76.5)		
20	32,100 (49)	32,100 (58)	28,150 (65)	25,000 (68.5)	19,650 (72.5)	16,500 (75)	11,850 (77)
25	25,650 (36)	25,450 (49.5)	25,200 (58.5)	25,000 (63.5)	19,650 (68)	16,500 (71)	11,850 (73.5)
30		18,650 (39.5)	18,150 (52)	17,800 (58)	18,050 (64)	16,500 (67.5)	11,850 (70.5)
35		13,650 (26)	13,300 (44.5)	13,000 (52)	14,500 (59.5)	15,750 (64)	11,850 (67)
40			9,800 (35.5)	9,550 (45.5)	10,800 (54.5)	11,850 (60)	11,850 (63.5)
45			7,420 (23)	7,190 (38)	8,400 (49.5)	9,410 (55.5)	10,150 (60)
50				5,300 (29)	6,410 (44)	7,340 (51)	8,040 (56.5)
55				3,810 (13.5)	4,840 (37.5)	5,700 (46.5)	6,360 (52.5)
60					3,590 (30)	4,370 (41.5)	5,000 (48.5)
65					2,560 (19.5)	3,280 (35.5)	3,650 (44)
70						2,300 (28.5)	2,400 (39)
75						1,400 (28.5)	1,520 (33.5)

NOTE: ( ) Boom angles are in degrees.

\*63 ft. boom length is with inner-mid extended and outer-mid and fly retracted.

A6-829-012233A

Boom Angle	37	45	55	*63	75	85
0°	19,300 (29.8)	11,200 (37.8)	6,310 (47.8)	3,610 (55.8)	2,070 (67.8)	1,180 (77.8)

A6-829-012233A



37 - 115 ft.  
(11.2 - 35 m)



9,500 lbs.  
(4309 kg)



Stationary  
29.5R 25 Tires



Defined Arc  
Over Front  
±6°



(Pounds)

(Feet)	37	45	55	*63	75	85	95
10	50,000 (68.5)	50,000 (73)					
12	50,000 (65)	50,000 (70)					
15	42,800 (59.5)	42,800 (65.5)	42,800 (70.5)				
20	34,100 (49)	34,100 (58)	34,100 (65)	27,250 (68.5)			
25	27,700 (36)	27,300 (49.5)	26,800 (58.5)	26,400 (63.5)	20,050 (68)	18,800 (71)	
30		19,600 (39.5)	19,050 (52)	18,600 (58)	19,850 (64)	18,800 (67.5)	15,500 (70.5)
35		14,400 (26)	14,000 (44.5)	13,650 (52)	14,750 (59.5)	15,650 (64)	13,400 (67)
40			10,450 (35.5)	10,150 (45.5)	11,200 (54.5)	12,050 (60)	11,550 (63.5)
45			7,710 (23)	7,620 (38)	8,580 (49.5)	9,390 (55.5)	9,840 (60)
50				5,650 (29)	6,580 (44)	7,350 (51)	8,120 (56.5)
55				4,100 (13.5)	4,990 (37.5)	5,730 (46.5)	6,470 (52.5)
60					3,780 (30)	4,460 (41.5)	5,140 (48.5)
65					2,700 (19.5)	3,420 (35.5)	4,040 (44)
70						2,520 (28.5)	3,110 (39)
75						1,550 (18.5)	2,250 (33.5)
80							1,300 (27)

NOTE: ( ) Boom angles are in degrees.

\*63 ft. boom length is with inner-mid extended and outer-mid and fly retracted.

A6-829-011792C

Boom Angle	37	45	55	*63	75	85
0°	20,350 (29.8)	12,300 (37.8)	6,710 (47.8)	3,900 (55.8)	2,000 (67.8)	1,090 (77.8)

A6-829-011904B



37 -115 ft.  
(11.2 - 35 m)



9,500 lbs.  
(4309 kg)



Stationary  
29.5R 25 Tires



360°



(Feet)



(Pounds)

(Feet)	37	45	55	*63	75	85	95
10	50,000 (68.5)	50,000 (73)					
12	46,550 (65)	46,400 (70)					
15	31,800 (59.5)	31,550 (65.5)	31,200 (70.5)				
20	19,550 (49)	19,200 (58)	18,800 (65)	18,450 (68.5)			
25	13,200 (36)	12,800 (49.5)	12,300 (58.5)	11,900 (63.5)	12,950 (68)	13,850 (71)	
30		8,860 (39.5)	8,330 (52)	7,910 (58)	8,880 (64)	9,690 (67.5)	10,500 (70.5)
35		5,990 (26)	5,550 (44.5)	5,190 (52)	6,100 (59.5)	6,860 (64)	7,620 (67)
40			3,540 (35.5)	3,240 (45.5)	4,100 (54.5)	4,350 (60)	4,350 (63.5)
45			1,730 (23)	1,520 (38)	1,520 (49.5)	1,520 (55.5)	1,520 (60)

NOTE: ( ) Boom angles are in degrees.

\*63 ft. boom length is with inner-mid extended and outer-mid and fly retracted.

A6-829-011793C

Boom Angle	37	45
0°	9,470 (29.8)	4,780 (37.8)

A6-829-011904B



37 - 115 ft.  
(11.2 - 35 m)



9,500 lbs.  
(4309 kg)



Pick & Carry  
Up to 2.5 MPH  
29.5R 25 Tires



Boom Centered Over Front



(Feet)	37	45	55	*63	75	85	95
10	57,700 (68.5)	57,700 (73)					
12	57,700 (65)	57,700 (70)					
15	57,700 (59.5)	57,700 (65.5)	57,700 (70.5)				
20	41,350 (49)	41,000 (58)	40,550 (65)	29,900 (68.5)			
25	27,700 (36)	27,300 (49.5)	26,800 (58.5)	26,400 (63.5)			
30		19,550 (39.5)	19,050 (52)	18,600 (58)	19,850 (64)	20,850 (67.5)	18,800 (70.5)
35		14,400 (26)	14,000 (44.5)	13,650 (52)	14,750 (59.5)	15,650 (64)	16,550 (67)
40			10,450 (35.5)	10,150 (45.5)	11,200 (54.5)	12,050 (60)	12,900 (63.5)
45			7,710 (23)	7,620 (38)	8,580 (49.5)	9,390 (55.5)	10,200 (60)
50				5,650 (29)	6,580 (44)	7,350 (51)	8,120 (56.5)
55				4,100 (13.5)	4,990 (37.5)	5,730 (46.5)	6,470 (52.5)
60					3,780 (30)	4,460 (41.5)	5,140 (48.5)
65					2,700 (19.5)	3,420 (35.5)	4,040 (44)
70						2,520 (28.5)	3,110 (39)
75						1,550 (18.5)	2,320 (33.5)
80							1,300 (27)

NOTE: ( ) Boom angles are in degrees.

\*63 ft. boom length is with inner-mid extended and outer-mid and fly retracted.

A6-829-011794C

Boom Angle	37	45	55	*63	75	85
0°	20,350 (29.8)	12,300 (37.8)	6,710 (47.8)	3,900 (55.8)	2,000 (67.8)	1,090 (77.8)

A6-829-011904B

# ***WEIGHT REDUCTIONS FOR LOAD HANDLING DEVICES***

<b>35 FT. BOOM EXTENSION</b>	
*Stowed -	670 lbs.
*Erected -	5,180 lbs.
<b>35 - 60 FT. TELE. BOOM EXTENSION</b>	
*Stowed -	896 lbs.
*Erected (Retracted) -	6,801 lbs.
*Erected (Extended) -	9,230 lbs.

\*Reduction of main boom capacities

<b>AUXILIARY BOOM HEAD</b>	<b>110 lbs.</b>
<b>HOOKBLOCKS and HEADACHE BALLS:</b>	
60 Ton, 5 Sheave w/cheekplates	1,809 lbs.+
60 Ton, 5 Sheave w/o cheekplates	1,445 lbs.+
15 Ton, 1 Sheave	420 lbs.+
10 Ton Headache Ball	560 lbs.+

+Refer to rating plate for actual weight.

# Superstructure specifications

## Boom

37 ft. - 115 ft. (11.2 m - 35 m) four-section full power boom. Maximum tip height: 125 ft. (38.0 m).

## \*Optional Boom

37 ft. - 89 ft. (11.2 m - 27 m) three-section full power boom. Maximum tip height: 99 ft. (30.0 m).

## Lattice Extension

35 ft. - 60 ft. (10.6 m - 18.2 m) telescoping lattice swingaway extension offsettable at 2° or 30°.

Stows alongside base boom section.

Maximum tip height: 184 ft. (56 m).

## \*Optional Lattice Extension

35 ft. (10.6 m) lattice swingaway extension. Offsettable at 2° or 30°. Stows alongside base boom section.

Maximum tip height: 159 ft. (48.5 m).

## Boom Nose

Four nylatron sheaves mounted on heavy duty tapered roller bearings with removable pin-type rope guards.

Quick reeving type boom nose. Removable auxiliary boom nose with removable pin type rope guard.

## Boom Elevation

One double acting hydraulic cylinder with integral holding valve provides elevation from -3° to 78°.

## Load Moment & Anti-Two Block System

Standard load moment and anti-two block system with audio-visual warning and control lever lockout.

These systems provide electronic display of boom angle, length, radius, tip height, relative load moment, maximum permissible load, load indication and warning of impending two-block condition.

## Cab

Full vision, all galvanealed steel fabricated with acoustical lining and tinted safety glass throughout.

Deluxe seat with armrest mounted hydraulic single axis controllers. Dash panel incorporates gauges for engine functions. Other standard features include: skylight screen, hydraulic oil cab heater/defroster, telescoping, tilt wheel, sliding side and rear windows, opening skylight, electric windshield wash-wipe, electric skylight wipers, fire extinguisher, seat belt, ashtray and level indicator.

## Swing

Planetary swing with foot applied multi-disc wet brake. Spring applied, hydraulically released swing brake, 360° positive swing lock (N.Y.C. style) and 1 position, mechanical house lock, operated from cab.

Maximum speed: 2.0 RPM.

## Counterweight

Removable: 9,500 lbs. (4309 kg).

2,155 lbs. (977 kg) slab in place of auxiliary hoist.

## Hydraulic System

Seven main pumps with a combined capacity 199.2 GPM (754 LPM).

Maximum operating pressure: 3500 PSI (241 bar).

Three individual valve banks.

Return line type filter with full flow by-pass protection and service indicator. Replaceable cartridge with micron filtration rating of 5/12/16.

200 gallons (757 L) reservoir. Remote mounted oil cooler with thermostatically controlled hydraulic motor driven fan/air to oil.

System pressure test panel with quick release type fittings for each circuit.

## Hoist Specifications Main and Auxiliary Hoist

Planetary reduction with automatic spring applied multi-disc brake. Electronic hoist drum rotation indicator, hoist drum cable followers and wire rope.

Maximum Single Line Pull: 16,969 lbs. (7697 kg)

Maximum Single Line Speed: 517 FPM (157 m/min)

Maximum Permissible Line Pull: 12,920 lbs. (5860 kg)

Rope Diameter: 3/4 in. (19 mm)

Rope Length: 550 ft. (167 m)

Maximum Rope Stowage: 1,163 ft. (354.5 m)

*\*Denotes optional equipment*



# Rated Lifting Capacities

## IMPORTANT NOTES:

### WARNING: THIS CHART IS ONLY A GUIDE.

The notes below are for illustration only and should not be relied upon to operate the crane. The individual crane's load chart, operating instructions and other instruction plates must be read and understood prior to operating the crane.

1. All rated loads meet ANSI/ASME B30.5, Mobile and Locomotive Cranes. Testing and development were performed to SAEJ1063, Cantilevered Boom Crane Structures - Method of Test, and SAEJ765 Crane Stability Test Code.

2. Capacities given do not include the weight of hookblocks, slings, auxiliary lifting equipment and load handling devices. Their weights must be added to the load to be lifted. When more than minimum required reeving is used, the additional rope weight shall be considered part of the load.





































3. Capacities appearing above the bold line are based on structural strength. Tipping should not be relied upon as a capacity indication.

4. All capacities are for crane on firm, level surface. It may be necessary to have structural supports under the outrigger floats or tires to spread the load to a larger bearing surface.

5. When either boom length or radius or both are between values listed, the smallest load shown at either the next larger radius or boom length shall be used.

6. For outrigger operation, ALL outriggers shall be properly extended with tires raised free of ground before raising the boom or lifting loads.

## Symbols Glossary

	Frame		Steering
	Outriggers		Transmission
	Outrigger Controls		Axles
	Engine		Brakes
	Fuel Tank Capacity		Tires
	Electrical System		Suspension
	Drive		Rotation
	Lights		Boom Elevation
	Cab		Swing
	Boom		Counterweight
	Fixed Swingaway		Oil
	Tele-Swingaway		Hydraulic System
	Jib		Hoist
	Boom Nose		Radius
	Boom Extension		Boom Length
	Speed		Hookblock
	Grade		Gear
	Lattice Extension		Luffing Jib

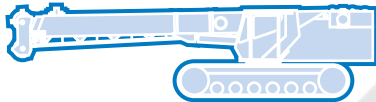
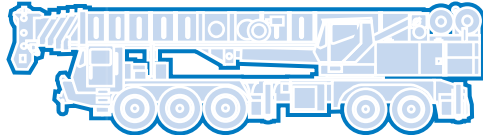
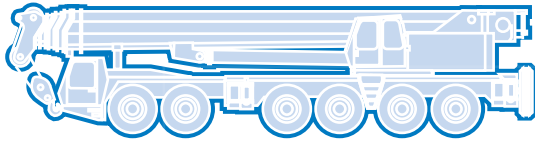
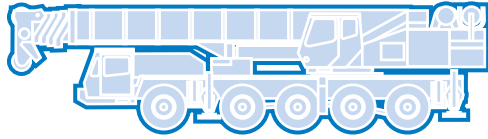

**GROVE**  
worldwide

**Grove Worldwide – World Headquarters**

**Grove U.S. L.L.C.**  
1565 Buchanan Trail East  
P.O. Box 21  
Shady Grove, Pennsylvania 17256, U.S.A.  
Tel: [Int + 1] (717) 597-8121  
Fax: [Int + 1] (717) 597-4062  
Western Hemisphere, Asia/Pacific

**Grove Europe Limited\***  
Sunderland SR4 6TT, England  
Tel: [Int + 44] 191 565-6281  
Fax: [Int + 44] 191 564-0442  
Europe, Africa, Middle East

**Grove Europe Limited\***  
Telford Road  
Bicester  
Oxon OX6 0TZ  
Tel: [Int + 44] 1869-878890  
Fax: [Int + 44] 1869-878888  
\*Grove Europe Limited, Registered in England,  
Number 1845128, Registered office, Crown Works,  
Pallion, Sunderland, Tyne & Wear, England SR4 6TT

**Deutsche Grove GmbH  
Sales and Service**  
Helmholtzstrasse 12, Postfach 5026  
D-40764 Langenfeld, Germany  
Tel: [Int + 49] (2173) 8909-0  
Fax: [Int + 49] (2173) 8909-30

**Wilhelmshaven Works**  
Industriegelände West, Postfach 1853  
D-22940 Wilhelmshaven, Germany  
Tel: [Int + 49] (4421) 294-443  
Fax: [Int + 49] (4421) 294-273

**Grove France S.A.**  
16, chaussée Jules-César, 95520 OSNY  
B.P. 203, 95523 CERGY PONTOISE CEDEX  
France  
Tel: [Int + 33] (1) 30313150  
Int: [Int + 33] (1) 30386085

**Grove Asia/Pacific - Regional Office**  
171 Chin Swee Road  
#06-01 San Centre  
Singapore 169877  
Tel: [Int + 65] 536-6112  
Fax: [Int + 65] 536-6119  
Asia/Pacific, Near East

**Grove China - Representative Office**  
Room 713, Towercrest Plaza  
No. 3 Mai Zi Dian West Road  
Chao Yang District  
Beijing, China 100016  
Tel: [Int + 86] (10) 64671690  
Fax: [Int + 86] (10) 64671691

**Grove Product Support**  
Western Hemisphere, Asia/Pacific  
1086 Wayne Avenue  
Chambersburg, Pennsylvania USA  
Tel: [Int + 1] (717) 263-5100  
Fax: [Int + 1] (717) 267-0404

Europe, Africa, Middle East  
Sunderland SR4 6TT, England  
Tel: [Int + 44] 191 565-6281  
Parts Fax: [Int + 44] 191 515-7475  
Service Fax: [Int + 44] 191 515-7340

<http://www.grovetworldwide.com>

Constant improvement and engineering progress make it necessary that we reserve the right to make specification, equipment, and price changes without notice. Illustrations shown may include optional equipment and accessories and may not include all standard equipment.

Distributed By: