

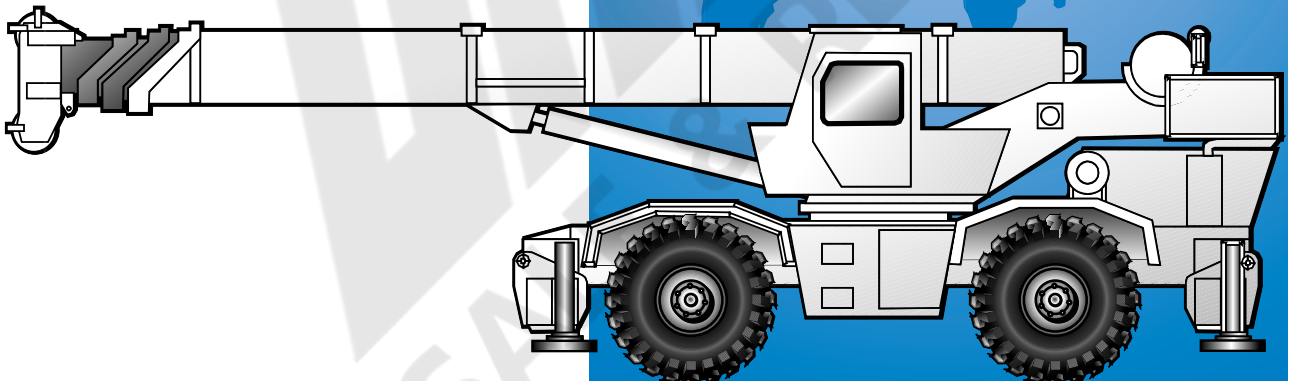

GROVE[®]
CRANE

A GROVE WORLDWIDE COMPANY

RT760



Rough Terrain Hydraulic Crane

Dimensions

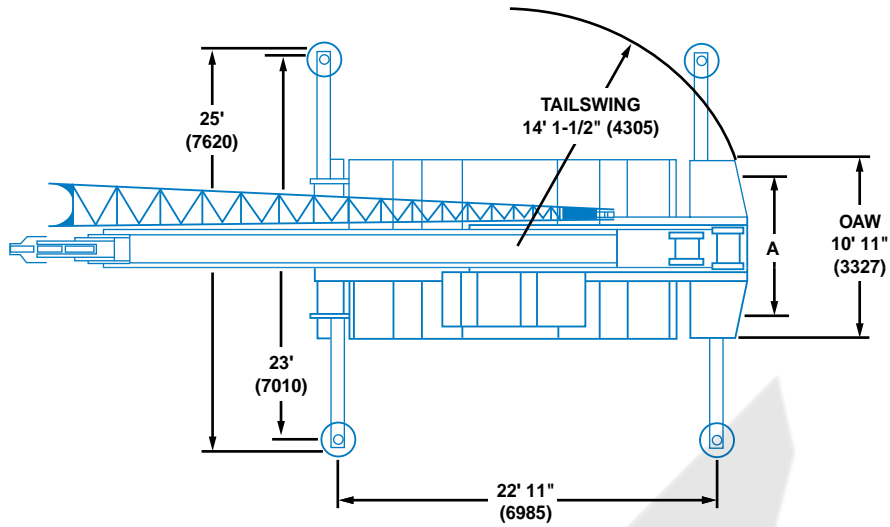

TIRE SIZE	29.5 x 25
A (TRACK)	8' 2-1/2" (2502)
B (OAH)	12' 5" (3785)
C	12' 9" (3886)
GROUND CLEARANCE	1' 6-1/2" (470)

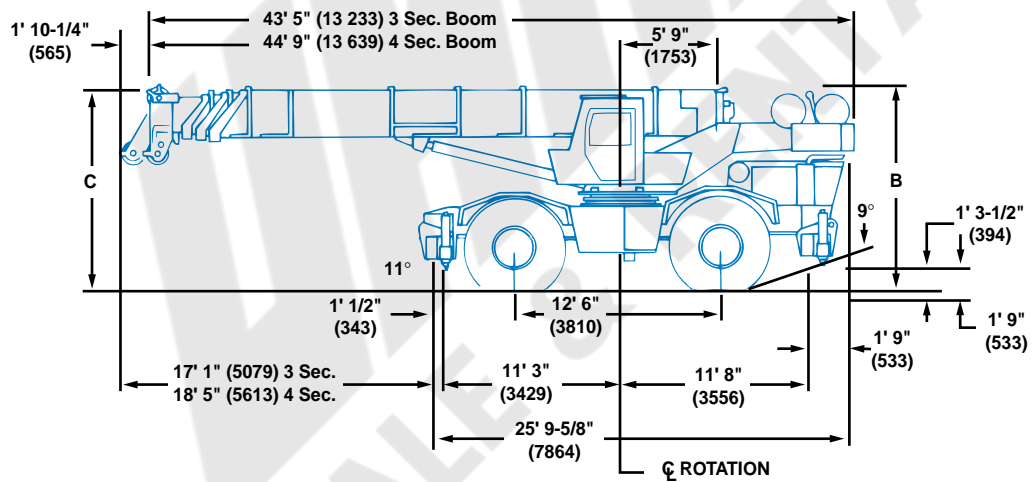

Note: () Dimensions are in mm.

- Turning Radius 23' 4" (7100 mm)
- Front Axle Load 45,805 lbs. (20 777 kg)
- Rear Axle Load 45,080 lbs. (20 448 kg)
- Gross Vehicle Weight 90,885 lbs. (41 225 kg)

Working range



35 - 110 ft.
(10.7 - 33.5 m)



32 - 56 ft.
(9.8 - 17.1 m)



13,900 lbs.
(6305 kg)

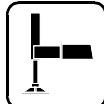

360°

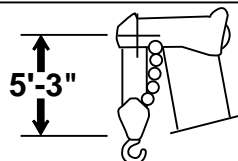
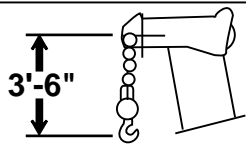
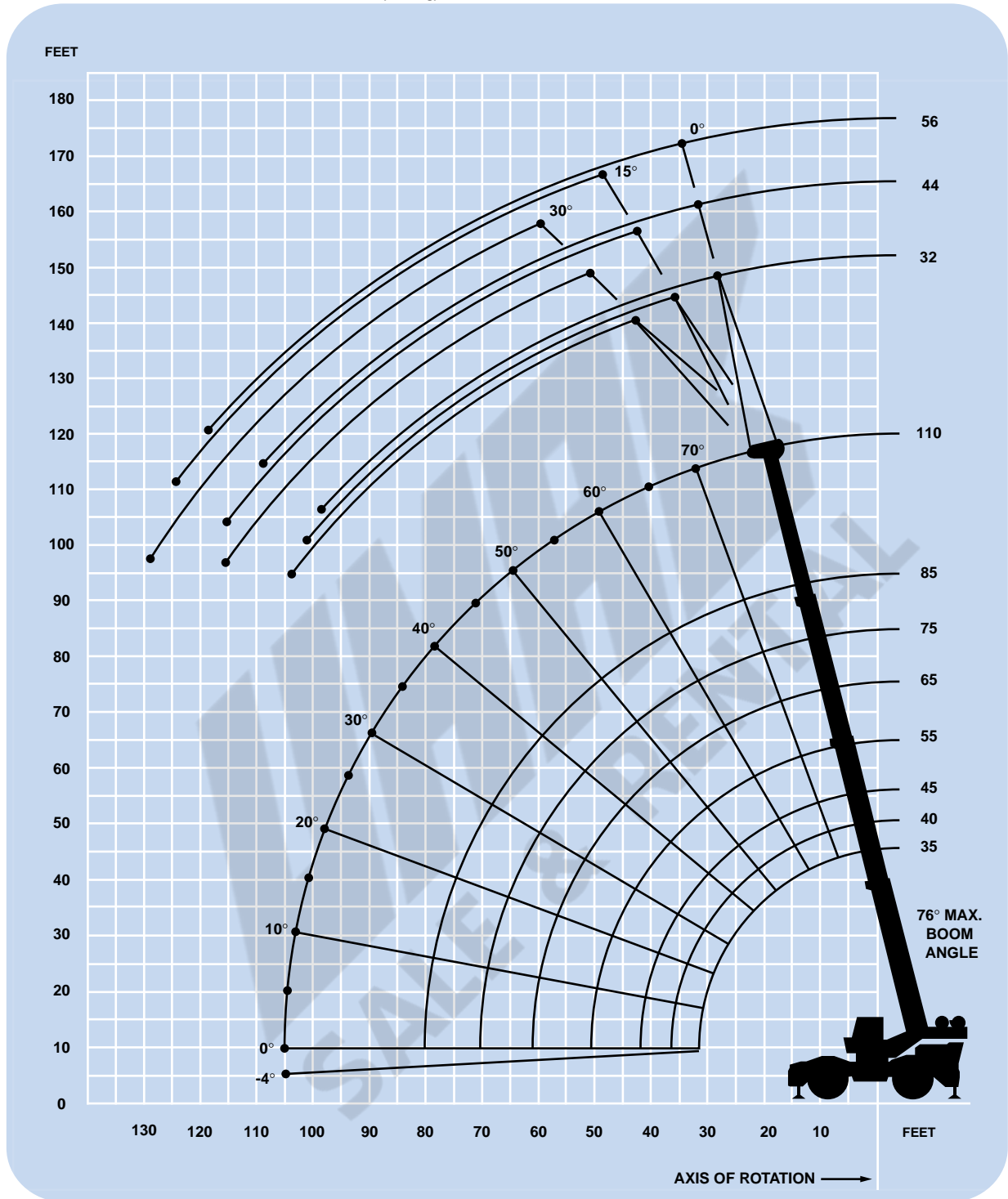

DIMENSIONS ARE FOR LARGEST GROVE FURNISHED HOOK BLOCK AND HEADACHE BALL, WITH ANTI-TWO BLOCK ACTIVATED.

Superstructure specifications

Boom

35 ft. - 110 ft. (10.7 m - 33.5 m) four-section boom consisting of a base section, two full power sections and one power pinned section.

Maximum tip height: 117 ft. (35.7 m).

*Optional Boom

34 ft. - 84 ft. (10.4 m - 25.6 m) three-section full power boom.

Maximum tip height: 92 ft. (28 m).

Lattice Extension (4 section boom)

32 ft. (9.8 m) lattice swingaway extension. Offsettable at 0°, 15° or 30°. Stows alongside base boom section.

Maximum tip height: 147 ft. (44.8 m).

*Optional Lattice Extension (4 section boom)

32 ft. - 56 ft. (9.8 m - 17.1 m) telescoping lattice swingaway extension offsettable at 0°, 15° or 30°. Stows alongside base boom section.

Maximum tip height: 170 ft. (51.8 m).

Lattice Extension (3 section boom)

32 ft. (9.8 m) fixed lattice swingaway extension. Stows alongside base boom section.

Maximum tip height: 122 ft. (37.2 m).

Boom Nose

Five steel sheaves mounted on heavy duty tapered roller bearings with removable pin-type rope guards.

*Optional auxiliary boom nose.

Boom Elevation

Two double acting hydraulic cylinders with integral holding valves provide elevation from -4° to 76°.

Load Moment & Anti-Two Block System

Standard load moment and anti-two block system with audio-visual warning and control lever lockout. These systems provide electronic display of boom angle, length, radius, tip height, relative load moment, maximum permissible load and load indication and warning of impending two-block condition.

Cab

Full vision, all steel fabricated with acoustical lining and tinted safety glass throughout. Complete driving controls and engine instrumentation. Dash mounted control levers for craning functions. Other standard features include: hinged skylight, sliding left side door and sliding right side window, electric windshield wash-wipe, propane heater, circulating air fan, fire extinguisher, seat belt and two front mounted worklights.

Swing

Ball bearing swing circle with 360° continuous rotation. Planetary glide swing with foot applied multi-disc brake. Spring applied, hydraulically released parking brake, plunger type one position and 360° mechanical house lock, operated from cab.

Maximum speed: 2.6 RPM.

Counterweight

Integral with turntable mast.

With main hoist only: 13,900 lbs. (6305 kg)

With main & aux.: 12,150 lbs. (5511 kg)

Hydraulic System

Four main pumps with a combined capacity of 146 GPM (553 LPM).

Maximum operating pressure: 2500 PSI (172.4 bar).

Four individual valve banks.

Return line type filter with full flow by-pass protection and service indicator. Replaceable cartridge with micron filtration rating of 15/30/38.

154 gallon (583 L) reservoir. Remote mounted oil cooler with thermostatically controlled electric motor driven fan/air to oil.

System pressure test panel with quick release type fittings for each circuit.

Hoist Specifications

Main and Auxiliary Hoist

Planetary reduction with automatic spring applied multi-disc brake. Electronic hoist drum rotation indicator, hoist drum cable followers and wire rope.

	High	Low
Maximum Single Line Pull:	9,280 lbs. (4209 kg)	18,560 lbs. (8419 kg)
Maximum Single Line Speed:	532 FPM (162 m/min)	266 FPM (81 m/min)
Maximum Permissible Line Pull:	12,920 lbs. (5860 kg)	12,920 lbs. (5860 kg)
Rope Diameter:	3/4" (19 mm)	3/4" (19 mm)
Rope Length:	550 ft. (168 m)	500 ft. (152 m)
Maximum Rope Stowage:	Main 1,170 ft. (357 m)	Auxiliary 690 ft. (210 m)

*Denotes optional equipment

Carrier specifications

Chassis

Box section chassis fabricated from high-strength, low alloy steel. Integral outrigger housings and front/rear towing and tie down lugs.

Outrigger System

Four hydraulic telescoping single-stage, double box beam outriggers with inverted jacks and integral holding valves. Three position setting. All steel fabricated, quick release type outrigger floats, 24" (610 mm) diameter.
Maximum outrigger pad load: 85,880 lbs. (39 036 kg).

Outrigger Controls

Controls and crane level indicator located in cab.

Engine

Cummins 6BTA 5.9L diesel, six cylinders, turbocharged, 200 bhp (149 kW) (Gross) @ 2,500 RPM.
Maximum torque: 600 ft. lbs. (814 Nm) @ 1,500 RPM.

*Optional Engine

Caterpillar 3116TA diesel, six cylinders, naturally aspirated, 190 bhp (142 kW) (Gross) @ 2,600 RPM.
Maximum torque: 490 ft. lbs. (664 Nm) @ 1,650 RPM.

Fuel Tank Capacity

60 gallons (227 L)

Transmission

Full powershift with 6 forward and 6 reverse speeds.
Rear axle disconnect for 4 x 2 travel.

Electrical System

Two 12-V - maintenance free batteries.
12-V starting.

Drive

4 x 4.

Steering

Fully independent power steering:
Front: Full hydraulic steering wheel controlled.
Rear: Full hydraulic hand lever controlled.
Provides infinite variations of 4 main steering modes: front only, rear only, crab and coordinated.
Rear steer indicating gauge.

Axles

Front: Drive steer with differential and planetary reduction hubs rigid mounted to chassis.
Rear: Drive/steer with differential and planetary reduction hubs pivot mounted to frame.
*Cross axle differential lock.

Oscillation Lockouts

Automatic full hydraulic lockouts on rear axle permit oscillation only with boom centered over the front.
*Oscillation lockout override control.

Brakes

Full air split circuit operating on all wheels.
Spring-applied, air released parking brake operating on front and rear axles.

Tires

29.5 x 25 - 28PR earthmover type, tubeless
*29.5R25 Radial

Lights

Full lighting including turn indicators, head, tail, brake, and hazard warning lights.

Maximum Speed

20.3 MPH (32.7 kph).

Gradeability (Theoretical)

128% (Based on 88,000 lbs. [39 917 kg] GVW)
29.5 x 25 tires, pumps disengaged, 84 ft. (25.6 m) boom, plus 32 ft. (9.8 m) swingaway.

Miscellaneous Standard Equipment

Full width steel fenders, dual rear view mirrors, hook block tiedown, electronic back-up alarm, front stowage well, light package, air dryer, 360° mechanical house lock and low oil pressure, high water temperature A/V warning system.

*Optional Equipment

- *360° flashing beacon
- *Cab spotlight
- *Engine block heater
- *Manual skylight wiper
- *Hookblocks/headacheball
- *Tow winch (front mounted max. single line pull 15,000 lbs. [6804 kg]; max. speed 92 FPM [28.0 m/min]).
- *Spare wheel assembly
- *Tire inflation kit
- *Tool kit
- *Pintle hook front/rear
- *Diesel heater/defroster
- *Hydraulic oil cab heater
- *Air conditioning
- *LMI light bar

**Denotes optional equipment*



35 - 110 ft.
(10.7 - 33.5 m)



13,900 lbs.
(6305 kg)



100%



360°



85% Domestic (Pounds)

Power Pinned Fly Retracted

Power Pin.
Fly Ext.
& 85 ft.

(Feet)	35	40	45	55	65	75	85	110
10	120,000 (65)	90,000 (68)	82,000 (71)	80,250 (75)				
12	99,000 (61)	90,000 (65)	82,000 (68)	75,000 (73)	67,000 (76)			
15	83,500 (55.5)	83,500 (60)	82,000 (64)	68,000 (69.5)	59,000 (73)			
20	64,350 (44.5)	64,350 (51)	64,300 (56.5)	55,750 (63.5)	49,000 (68.5)	43,000 (72)	39,350 (74.5)	
25	49,450 (31)	49,450 (41)	49,450 (48.5)	47,900 (57.5)	40,400 (63.5)	35,550 (68)	33,000 (71)	27,100 (76)
30		39,600 (28)	39,600 (39)	39,600 (51)	34,350 (58.5)	31,000 (63.5)	27,800 (67.5)	23,450 (74)
35			32,400 (26.5)	32,400 (44)	29,750 (53)	26,550 (59)	23,900 (63.5)	20,600 (71)
40				24,248 (35.5)	24,280 (47)	23,200 (54.5)	20,850 (60)	18,350 (68)
45				19,250 (24.5)	19,250 (40.5)	19,250 (49.5)	18,300 (55.5)	16,450 (65)
50					15,830 (32.5)	15,830 (44)	15,830 (51.5)	14,750 (62)
55					13,330 (22.5)	13,330 (38)	13,330 (46.5)	13,250 (59)
60						11,450 (31)	11,450 (41.5)	11,950 (56)
65						9,760 (21.5)	9,760 (36)	10,800 (52.5)
70							8,150 (29.5)	9,730 (49)
75							6,620 (20.5)	8,450 (45.5)
80								7,460 (41.5)
85								6,530 (37)
90								5,620 (32)
95								4,750 (26.5)
100								3,940 (18.5)
Minimum boom angle (deg.) for indicated length (no load)							0	0
Maximum boom length (ft.) at 0 deg. boom angle (no load)							85	110

Note: () Boom angles are in degrees.

A6-829-008610 & -004949C

Boom Angle	35	40	45	55	65	75	85	110
0°	24,550 (29.6)	20,550 (34.3)	17,200 (39.3)	12,350 (49.3)	9,030 (59.3)	6,580 (69.3)	4,720 (79.2)	2,930 (104)

Note: () Reference radii in feet.

A6-829-009455



35 - 110 ft.
(10.7 - 33.5 m)



13,900 lbs.
(6305 kg)



50%



360°



85% Domestic (Pounds)

(Feet)	Power Pinned Fly Retracted							Power Pin. Fly Ext. & 85 ft. 110
	35	40	45	55	65	75	85	
10	109,500 (65)	90,000 (68)	82,000 (71)	80,250 (75)				
12	97,250 (61)	90,000 (65)	82,000 (68)	75,000 (73)	67,000 (76)			
15	82,600 (55.5)	82,600 (60)	82,000 (64)	68,000 (69.5)	59,000 (73)			
20	53,000 (44.5)	53,000 (51)	53,000 (56.5)	53,000 (63.5)	49,000 (68.5)	43,000 (72)	39,350 (74.5)	
25	36,100 (31)	36,100 (41)	36,100 (48.5)	36,100 (57.5)	36,100 (63.5)	35,350 (68)	33,000 (71)	27,100 (76)
30		26,400 (28)	26,400 (39)	26,400 (51)	26,400 (58.5)	26,400 (63.5)	25,800 (67.5)	23,450 (74)
35			20,400 (26.5)	20,400 (44)	20,400 (53)	20,400 (59)	20,100 (63.5)	20,600 (71)
40				14,800 (35.5)	14,800 (47)	14,800 (54.5)	14,800 (60)	17,050 (68)
45				11,450 (24.5)	11,450 (40.5)	11,450 (49.5)	11,450 (55.5)	14,050 (65)
50					9,240 (32.5)	9,240 (44)	9,240 (51.5)	11,700 (62)
55					7,610 (22.5)	7,610 (38)	7,610 (46.5)	9,800 (59)
60						6,400 (31)	6,400 (41.5)	8,180 (56)
65						5,240 (21.5)	5,240 (36)	6,800 (52.5)
70							4,080 (29.5)	5,580 (49)
75							2,920 (20.5)	4,670 (45.5)
80								3,930 (41.5)
85								3,180 (37)
90								2,510 (32)
95								1,920 (26.5)
100								1,340 (18.5)
Minimum boom angle (deg.) for indicated length (no load)							0	0
Maximum boom length (ft.) at 0 deg. boom angle (no load)							85	110
Note: () Boom angles are in degrees.								
Boom Angle	35	40	45	55	65	75	85	
0°	24,550 (29.6)	20,550 (34.3)	15,550 (39.3)	9,540 (49.3)	6,570 (59.3)	4,250 (69.3)	1,960 (79.2)	

Note: () Reference radii in feet.

A6-829-012347A



35 - 110 ft.
(10.7 - 33.5 m)



13,900 lbs.
(6305 kg)



0%



360°



75% Domestic (Pounds)

Power Pin.
Fly Ext.
& 85 ft.

Power Pinned Fly Retracted

(Feet)	35	40	45	55	65	75	85	110
10	83,400 (65)	80,050 (68)	76,750 (71)	70,900 (75)				
12	53,850 (61)	53,850 (65)	53,850 (68)	53,850 (73)	52,000 (76)			
15	34,750 (55.5)	34,750 (60)	34,750 (64)	34,750 (69.5)	34,750 (73)			
20	20,600 (44.5)	20,600 (51)	20,600 (56.5)	20,600 (63.5)	20,600 (68.5)	20,600 (72)	20,600 (74.5)	
25	14,850 (31)	14,850 (41)	14,850 (48.5)	14,850 (57.5)	14,850 (63.5)	14,850 (68)	14,850 (71)	17,600 (76)
30		10,900 (28)	10,900 (39)	10,900 (51)	10,900 (58.5)	10,900 (63.5)	10,900 (67.5)	13,450 (74)
35			8,280 (26.5)	8,280 (44)	8,280 (53)	8,280 (59)	8,280 (63.5)	10,400 (71)
40				5,200 (35.5)	5,200 (47)	5,200 (54.5)	5,200 (60)	8,140 (68)
45				3,510 (24.5)	3,510 (40.5)	3,510 (49.5)	3,510 (55.5)	6,340 (65)
50					2,420 (32.5)	2,420 (44)	2,420 (51.5)	4,890 (62)
55					1,660 (22.5)	1,660 (38)	1,660 (46.5)	3,690 (59)
60						1,110 (31)	1,110 (41.5)	2,690 (56)
65								1,840 (52.5)
70								1,110 (49)
Minimum boom angle (deg.) for indicated length (no load)							40.5	48.5
Maximum boom length (ft.) at 0 deg. boom angle (no load)							65	75
Note: () Boom angles are in degrees.								
Boom Angle	35	40	45	55	65			
0°	11,150 (29.6)	8,650 (34.3)	5,620 (39.3)	2,570 (49.3)	1,190 (59.3)			

Note: () Reference radii in feet.

A6-829-012349A



35 - 110 ft.
(10.7 - 33.5 m)



32 - 56 ft.
(9.8 - 17.1 m)



13,900 lbs.
(6305 kg)



100%



360°

BOOM
ANGLE



85% Domestic (Pounds)

POWER PINNED FLY RETRACTED

(Degrees)	32 ft. LENGTH			44 ft. LENGTH			56 ft. LENGTH		
	0° OFFSET	15° OFFSET	30° OFFSET	0° OFFSET	15° OFFSET	30° OFFSET	0° OFFSET	15° OFFSET	30° OFFSET
75	20,000 (26.7)	15,000 (33.2)	10,000 (37.9)	13,000 (31.1)	8,600 (40.5)	6,300 (48.5)	9,000 (35.4)	6,700 (48.3)	4,700 (58.3)
70	16,900 (36.2)	12,500 (42.2)	9,100 (46.7)	11,300 (41.7)	7,800 (50.7)	5,800 (58.0)	7,600 (46.7)	5,900 (59.2)	4,200 (68.3)
65	14,500 (45.3)	10,900 (50.9)	8,300 (55.1)	10,000 (51.9)	7,000 (60.4)	5,300 (67.0)	6,500 (57.7)	5,300 (69.7)	3,900 (77.8)
60	12,500 (54.1)	9,500 (59.1)	7,500 (63.1)	8,800 (61.8)	6,300 (69.7)	5,100 (75.5)	5,600 (68.3)	4,700 (79.6)	3,700 (86.7)
55	10,800 (62.5)	8,300 (66.9)	6,700 (70.5)	7,600 (71.2)	5,700 (78.5)	4,900 (83.4)	4,700 (78.3)	4,200 (88.9)	3,500 (94.8)
50	8,480 (70.4)	7,200 (74.1)	5,900 (77.3)	6,800 (80.0)	5,300 (86.6)	4,700 (90.6)	4,200 (87.7)	3,800 (97.6)	3,400 (102.2)
45	6,550 (77.7)	5,870 (80.7)	5,100 (83.5)	5,760 (88.2)	4,740 (94.0)	4,260 (97.1)	3,900 (96.5)	3,700 (105.4)	3,300 (108.9)

POWER PINNED FLY EXTENDED

75	11,900 (36.6)	9,100 (41.7)	7,500 (46.9)	*9,000 (41.9)	7,400 (53.0)	5,600 (60.0)	**7,000 (47.6)	6,100 (60.9)	4,400 (69.2)
70	10,400 (48.1)	8,300 (52.9)	7,000 (57.7)	8,800 (54.4)	6,600 (64.9)	5,200 (71.0)	6,900 (60.8)	5,400 (73.2)	4,000 (81.0)
65	8,700 (59.2)	7,400 (63.7)	6,500 (68.1)	7,600 (66.4)	5,900 (76.3)	4,700 (81.5)	5,700 (73.7)	4,800 (84.9)	3,800 (92.2)
60	7,600 (69.9)	6,500 (74.0)	5,900 (77.9)	6,400 (78.0)	5,400 (87.1)	4,600 (91.4)	5,000 (86.0)	4,300 (96.0)	3,600 (102.7)
55	6,900 (80.1)	5,900 (83.8)	5,500 (87.1)	5,600 (90.0)	4,770 (97.3)	4,200 (100.6)	4,200 (97.6)	3,700 (106.4)	3,300 (112.4)
50	5,150 (89.6)	4,590 (92.8)	4,140 (95.6)	4,470 (99.3)	3,460 (106.8)	3,190 (109.0)	3,700 (108.6)	3,130 (116.0)	2,590 (121.3)
45	3,710 (98.4)	3,320 (101.2)	3,030 (103.3)	3,200 (108.9)	2,480 (115.4)	2,370 (116.5)	2,840 (118.8)	2,260 (124.8)	1,880 (129.2)

NOTE: () Reference radii in feet.

*If two parts of line are used, the capacity increases to 10,200 lbs.

**If two parts of line are used, the capacity increases to 8,400 lbs.

A6-829-008169 & -008179A



35 - 110 ft.
(10.7 - 33.5 m)

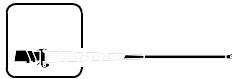

32 - 56 ft.
(9.8 m - 17.1 m)



13,900 lbs.
(6305 kg)



50%



360°

BOOM
ANGLE



85% Domestic (Pounds)

POWER PINNED FLY RETRACTED

(Degrees)	32 FT. LENGTH			44 FT. LENGTH			56 FT. LENGTH		
	0° OFFSET	15° OFFSET	30° OFFSET	0° OFFSET	15° OFFSET	30° OFFSET	0° OFFSET	15° OFFSET	30° OFFSET
75	20,000 (26.7)	15,000 (33.2)	10,000 (37.9)	13,000 (31.1)	8,600 (40.5)	6,300 (48.5)	9,000 (35.4)	6,700 (48.3)	4,700 (58.3)
70	16,900 (36.2)	12,500 (42.2)	9,100 (46.7)	11,300 (41.7)	7,800 (50.7)	5,800 (58.0)	7,600 (46.7)	5,900 (59.2)	4,200 (68.3)
65	12,500 (45.3)	10,900 (50.9)	8,300 (55.1)	10,000 (51.9)	7,000 (60.4)	5,300 (67)	6,500 (57.7)	5,300 (69.7)	3,900 (77.8)
60	8,780 (54.1)	7,730 (59.1)	6,470 (63.1)	7,250 (61.8)	6,070 (69.7)	4,790 (75.5)	5,600 (68.3)	4,700 (79.6)	3,700 (86.7)
55	6,200 (62.5)	5,410 (66.9)	4,530 (70.5)	5,060 (71.2)	4,230 (78.5)	3,370 (83.4)	4,480 (78.3)	3,580 (88.9)	2,770 (94.8)
50	4,350 (70.4)	3,750 (74.1)	3,110 (77.3)	3,490 (80)	2,880 (86.6)	2,050 (90.6)	3,100 (87.7)	2,430 (97.6)	1,890 (102.2)
45	2,990 (77.7)	2,510 (80.7)	2,050 (83.5)	2,320 (88.2)	1,870 (94.0)	1,500 (97.1)	2,060 (96.5)	1,560 (105.4)	1,220 (108.9)

POWER PINNED FLY EXTENDED

75	11,900 (36.6)	9,100 (41.7)	7,500 (46.9)	*9,000 (41.9)	7,400 (53.0)	5,600 (60)	**7,000 (47.6)	6,100 (60.9)	4,400 (69.2)
70	10,400 (48.1)	8,300 (52.9)	7,000 (57.7)	8,800 (54.4)	6,600 (64.9)	5,200 (71.0)	6,900 (60.8)	5,400 (73.2)	4,000 (81.0)
65	7,440 (59.2)	7,070 (63.7)	6,500 (68.1)	6,260 (66.4)	5,200 (76.3)	4,490 (81.5)	5,350 (73.7)	4,520 (84.9)	3,540 (92.2)
60	4,860 (69.9)	4,730 (74.0)	4,220 (77.9)	4,050 (78.0)	3,440 (87.1)	2,880 (91.4)	3,440 (86.0)	3,020 (96.0)	2,210 (102.7)
55	3,050 (80.1)	3,040 (83.8)	2,550 (87.1)	2,370 (90.0)	2,090 (97.3)	1,690 (100.6)	2,090 (97.6)	1,810 (106.4)	1,220 (112.4)
50	1,730 (89.6)	1,700 (92.8)	1,330 (95.6)	1,340 (99.3)	1,020 (106.8)		1,070 (108.6)		

*If 2 parts of line are used, the capacity increases to 10,200 lbs.

**If 2 parts of line are used, the capacity increases to 8,400 lbs.

A6-829-012348A



35 - 110 ft.
(10.7 - 33.5 m)

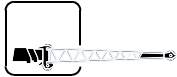

32 ft.
(9.8 m)



13,900 lbs.
(6305 kg)



100%



360°

BOOM
ANGLE



85% Domestic (Pounds)

POWER PINNED FLY RETRACTED

(Degrees)	0° OFFSET	15° OFFSET	30° OFFSET
75	20,600 (26.7)	15,600 (33.2)	10,600 (37.9)
70	17,500 (36.2)	13,100 (42.2)	9,700 (46.7)
65	15,100 (45.3)	11,500 (50.9)	8,900 (55.1)
60	13,200 (54.1)	10,200 (59.1)	8,200 (63.1)
55	11,300 (62.5)	8,900 (66.9)	7,300 (70.5)
50	8,950 (70.4)	7,800 (74.1)	6,500 (77.3)
45	7,020 (77.7)	6,330 (80.7)	5,700 (83.5)

POWER PINNED FLY EXTENDED

75	12,500 (36.6)	9,700 (41.7)	8,100 (46.9)
70	11,000 (48.1)	8,900 (52.9)	7,600 (57.7)
65	9,300 (59.2)	8,000 (63.7)	7,100 (68.1)
60	8,300 (69.9)	7,200 (74.0)	6,600 (77.9)
55	7,400 (80.1)	6,500 (83.8)	6,080 (87.1)
50	5,650 (89.6)	5,080 (92.8)	4,610 (95.6)
45	4,220 (98.4)	3,800 (101.2)	3,520 (103.3)

NOTE: () Reference radii in feet.

A6-829-008604 & -008600



35 - 110 ft.
(10.7 - 33.5 m)

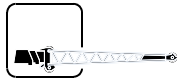

32 ft.
(9.8 m)



13,900 lbs.
(6305 kg)



50%



360°

BOOM
ANGLE



85% Domestic (Pounds)

POWER PINNED FLY RETRACTED

(Degrees)	0° OFFSET	15° OFFSET	30° OFFSET
75	20,600 (26.7)	15,600 (33.2)	10,600 (37.9)
70	17,500 (36.2)	13,100 (42.2)	9,700 (46.7)
65	12,950 (45.3)	11,500 (50.9)	8,900 (55.1)
60	9,230 (54.1)	8,170 (59.1)	6,890 (63.1)
55	6,650 (62.5)	5,860 (66.9)	4,970 (70.5)
50	4,800 (70.4)	4,200 (74.1)	3,560 (77.3)
45	3,460 (77.7)	2,980 (80.7)	2,510 (83.5)

POWER PINNED FLY EXTENDED

75	12,500 (36.6)	9,700 (41.7)	8,100 (46.9)
70	11,000 (48.1)	8,900 (52.9)	7,600 (57.7)
65	7,890 (59.2)	7,520 (63.7)	7,000 (68.1)
60	5,320 (69.9)	5,200 (74.0)	4,680 (77.9)
55	3,520 (80.1)	3,510 (83.8)	3,020 (87.1)
50	2,220 (89.6)	2,190 (92.8)	1,810 (95.6)
45	1,240 (98.4)	1,140 (101.2)	

NOTE: () Reference radii in feet.

A6-829-014094A



35 - 110 ft.
(10.7 - 33.5 m)



13,900 lbs.
(6305 kg)



Stationary
29.5 X 25 - 28PR Tires



360°



75% Domestic (Pounds)

(Feet)	35	40	45	55	65
10	52,820 (65)	34,950 (68)			
12	44,820 (61)	29,200 (65)	29,200 (68)		
15	31,320 (55.5)	23,000 (60)	23,000 (64)	23,000 (69.5)	
20	18,890 (44.5)	16,050 (51)	16,050 (56.5)	16,050 (63.5)	
25	12,880 (31)	11,450 (41)	11,450 (48.5)	11,450 (57.5)	
30		8,520 (28)	8,290 (39)	8,290 (51)	
35			5,790 (26.5)	5,790 (44)	5,790 (53)
40				3,840 (35.5)	3,840 (47)
45				2,530 (24.5)	2,530 (40.5)
50					1,280 (32.5)

Note: () Boom angles are in degrees.

Boom Angle	35	40	45	55
0°	8,780 (29.6)	6,120 (34.3)	4,160 (39.3)	1,470 (49.3)

Note: () Reference radii in feet.

A6-829-010775



35 - 110 ft.
(10.7 - 33.5 m)



13,900 lbs.
(6305 kg)



Stationary
29.5 X 25 - 28PR Tires



Defined Arc
Over Front



75% Domestic (Pounds)

(Feet)	35	40	45	55	65	75	85
10	65,150 (65)	47,250 (68)					
12	53,630 (61)	40,600 (65)	40,600 (68)				
15	42,070 (55.5)	33,100 (60)	33,100 (64)	33,100 (69.5)			
20	31,470 (44.5)	24,500 (51)	24,500 (56.5)	24,500 (63.5)			
25	23,080 (31)	19,210 (41)	18,800 (48.5)	18,800 (57.5)			
30		16,950 (28)	14,700 (39)	14,700 (51)			
35			12,530 (26.5)	11,650 (44)	11,650 (53)		
40				9,520 (35.5)	9,250 (47)		
45				7,230 (24.5)	7,230 (40.5)		
50					5,430 (32.5)		
55					3,990 (22.5)		
60						2,850 (31)	
65						2,010 (21.5)	1,500 (36)
70							1,320 (29.5)

Note: () Boom angles are in degrees.

Boom Angle	35	40	45	55	65	75
0°	17,350 (29.6)	13,100 (34.3)	9,900 (39.3)	5,680 (49.3)	3,010 (59.3)	1,400 (69.3)

Note: () Reference radii in feet.

A6-829-010774



35 - 110 ft.
(10.7 - 33.5 m)



13,900 lbs.
(6305 kg)



Pick & Carry
up to 2.5 MPH
29.5 X 25 - 28PR Tires



Boom Centered
Over Front



75% Domestic (Pounds)

(Feet)	35	40	45	55	65	75	85
10	47,000 (65)	45,100 (68)	45,100 (71)				
12	42,020 (61)	38,950 (65)	38,950 (68)				
15	34,160 (55.5)	31,950 (60)	31,950 (64)	31,950 (69.5)			
20	30,480 (44.5)	23,850 (51)	23,850 (56.5)	23,850 (63.5)	23,850 (68.5)	23,850 (72)	
25	23,080 (31)	19,210 (41)	18,400 (48.5)	18,400 (57.5)	18,400 (63.5)	18,400 (68)	
30		16,950 (28)	14,450 (39)	14,450 (51)	14,450 (58.5)	14,450 (63.5)	
35			12,530 (26.5)	11,450 (44)	11,450 (53)	11,450 (59)	11,450 (63.5)
40				9,520 (35.5)	9,150 (47)	9,150 (54.5)	9,150 (60)
45				7,230 (24.5)	7,230 (40.5)	7,230 (49.5)	7,230 (55.5)
50					5,430 (32.5)	5,430 (44)	5,430 (51.5)
55					3,990 (22.5)	3,990 (38)	3,990 (46.5)
60						2,850 (31)	2,850 (41.5)
65						2,010 (21.5)	1,500 (36)
70							1,320 (29.5)

Note: () Boom angles are in degrees.

Boom Angle	35	40	45	55	65	75
0°	17,350 (29.6)	13,100 (34.3)	9,900 (39.3)	5,680 (49.3)	3,010 (59.3)	1,400 (69.3)

Note: () Reference radii in feet.

A6-829-010776

Weight Reductions for Load Handling Devices

32 FT. BOOM EXTENSION

*Stowed -	930 lbs.
*Erected -	5,519 lbs.

32 FT. - 56 FT. BOOM EXTENSION

*Stowed -	1,163 lbs.
*Erected (Retracted) -	6,996 lbs.
*Erected (Extended) -	8,945 lbs.

*Reduction of main boom capacities

AUXILIARY BOOM HEAD	220 lbs.
----------------------------	-----------------

HOOKBLOCKS and HEADACHE BALLS:

60 Ton, 5 Sheave	1,370 lbs.+
15 Ton, 1 Sheave	380 lbs.+
7 1/2 Ton Headache Ball	338 lbs.+
10 Ton Headache Ball	560 lbs.+

+Refer to rating plate for actual weight.

Rated lifting capacities



































IMPORTANT NOTES:

WARNING: THIS CHART IS ONLY A GUIDE.

The notes below are for illustration only and should not be relied upon to operate the crane. The individual crane's load chart, operating instructions and other instruction plates must be read and understood prior to operating the crane.

- All rated loads have been tested to and meet minimum requirements of SAE J1063 NOV93 - Cantilevered Boom Crane Structures - Method of Test, and do not exceed 85% of the tipping load on outriggers fully extended and 50% extended, and 75% of the tipping load on outriggers 0% extended (fully retracted) and rubber, as determined by SAE J765 OCT90 Crane Stability Test Code.
- Capacities given do not include the weight of hookblocks, slings, auxiliary lifting equipment and load handling devices. Their weights must be added to the load to be lifted. When more than minimum required reeving is used, the additional rope weight shall be considered part of the load.
- Defined Arc $\pm 6^\circ$ on either side of longitudinal centerline of machine.
- Capacities appearing above the bold line are based on structural strength. Tipping should never be relied upon as a capacity limit indicator.
- All capacities are for crane on firm, level surface. It may be necessary to have structural supports under the outrigger floats or tires to spread the load to a larger bearing surface.
- When either boom length or radius or both are between values listed, the smallest load shown at either the next larger radius or boom length shall be used.
- Tires shall be inflated to the recommended pressure before lifting on rubber.
- For outrigger operation, ALL outriggers shall be properly extended with tires raised free of ground before raising the boom or lifting loads.

Symbols Glossary

	Frame		Steering
	Outriggers		Transmission
	Outrigger Controls		Axles
	Engine		Brakes
	Fuel Tank Capacity		Tires
	Electrical System		Suspension
	Drive		Rotation
	Lights		Boom Elevation
	Cab		Swing
	Boom		Counterweight
	Fixed Swingaway		Oil
	Tele-Swingaway		Hydraulic System
	Jib		Hoist
	Boom Nose		Radius
	Boom Extension		Boom Length
	Speed		Hookblock
	Grade		Gear
	Lattice Extension		Luffing Jib

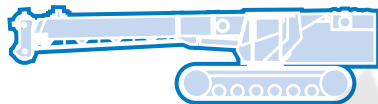
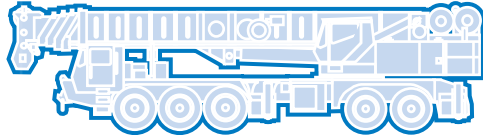
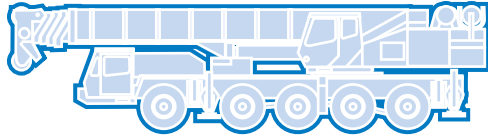

GROVE
worldwide

Grove Worldwide – World Headquarters

Grove North America
1565 Buchanan Trail East
P.O. Box 21
Shady Grove, Pennsylvania 17256, U.S.A.
Tel: [Int + 1] (717) 597-8121
Fax: [Int + 1] (717) 597-4062
Western Hemisphere, Asia/Pacific

Grove Europe Limited*

Sunderland SR4 6TT, England
Tel: [Int + 44] 191 565-6281
Fax: [Int + 44] 191 564-0442
Europe, Africa, Middle East

Grove Europe Limited*

P.O. Box No. 268
4A Kimber Road
Abingdon, Oxfordshire, OX141SG
Tel: [Int + 44] 1235 55-3184
Fax: [Int + 44] 1235 55-3218

Deutsche Grove GmbH

Sales and Service
Helmholtzstrasse 12, Postfach 5026
D-40750 Langenfeld, Germany
Tel: [Int + 49] (2173) 8909-0
Fax: [Int + 49] (2173) 8909-30

Wilhelmshaven Works

Industriegelände West, Postfach 1853
D-26358 Wilhelmshaven, Germany
Tel: [Int + 49] (4421) 294-0
Fax: [Int + 49] (4421) 294-301

Grove France S.A.

16, chaussée Jules-César, 95520 OSNY
B.P. 203, 95523 CERGY PONTOISE CEDEX
France
Tel: [Int + 33] (1) 30313150
Int: [Int + 33] (1) 30386085

*Grove Europe Limited, Registered in England,
Number 1845128, Registered office, Crown Works,
Pallion, Sunderland, Tyne & Wear, England SR4 6TT

Grove Asia/Pacific - Regional Office

171 Chin Swee Road
#06-01 San Centre
Singapore 0316
Tel: [Int + 65] 536-6112
Fax: [Int + 65] 536-6119
Asia/Pacific, Near East

Grove China - Representative Office

Beijing Hotel Room 6074
No. 33 East Chang An Avenue
Beijing, 100004, China
Tel: [Int + 86] (10) 513-7766
Fax: [Int + 86] (10) 513-7307

Grove Product Support

Western Hemisphere, Asia/Pacific
1086 Wayne Avenue
Chambersburg, Pennsylvania USA
Tel: [Int + 1] (717) 263-5100
Fax: [Int + 1] (717) 267-0404

Europe, Africa, Middle East
Sunderland SR4 6TT, England
Tel: [Int + 44] 191 565-6281
Parts Fax: [Int + 44] 191 510-9242
Service Fax: [Int + 44] 191 510-9560

Constant improvement and engineering progress make it necessary that we reserve the right to make specification, equipment, and price changes without notice. Illustrations shown may include optional equipment and accessories and may not include all standard equipment.

Distributed By: