

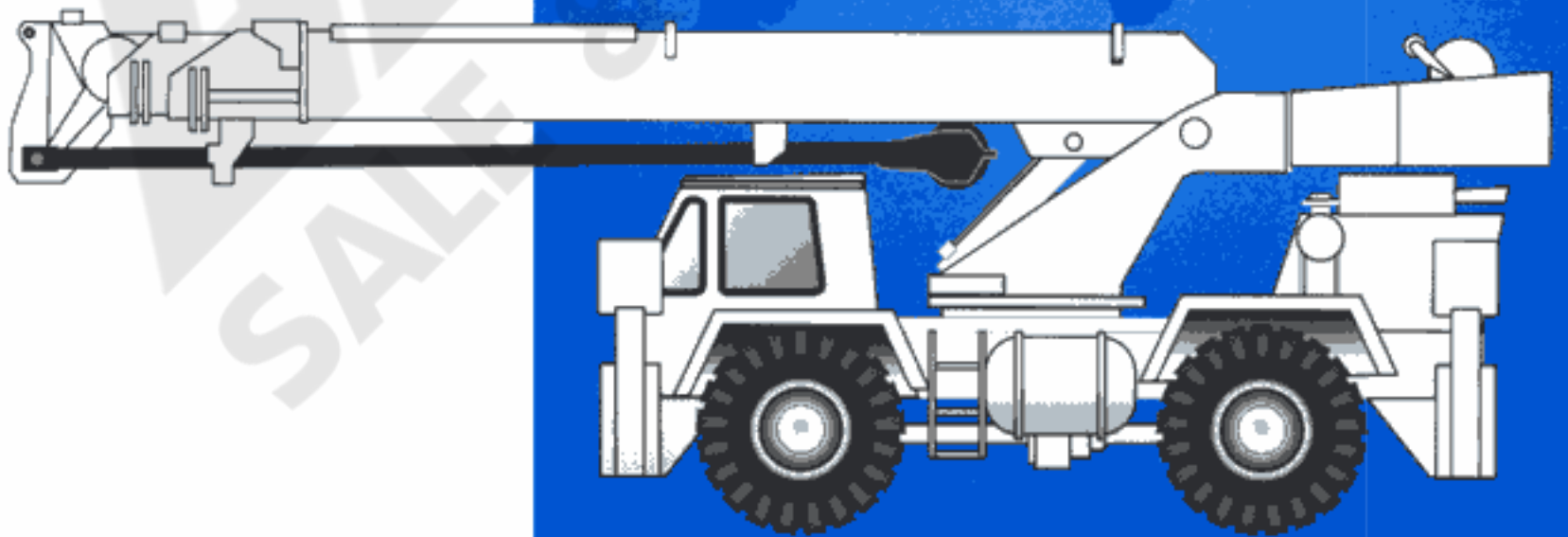

GROVE[®]
CRANE

A GROVE WORLDWIDE COMPANY

RT58B



Rough Terrain Hydraulic Crane

Dimensions

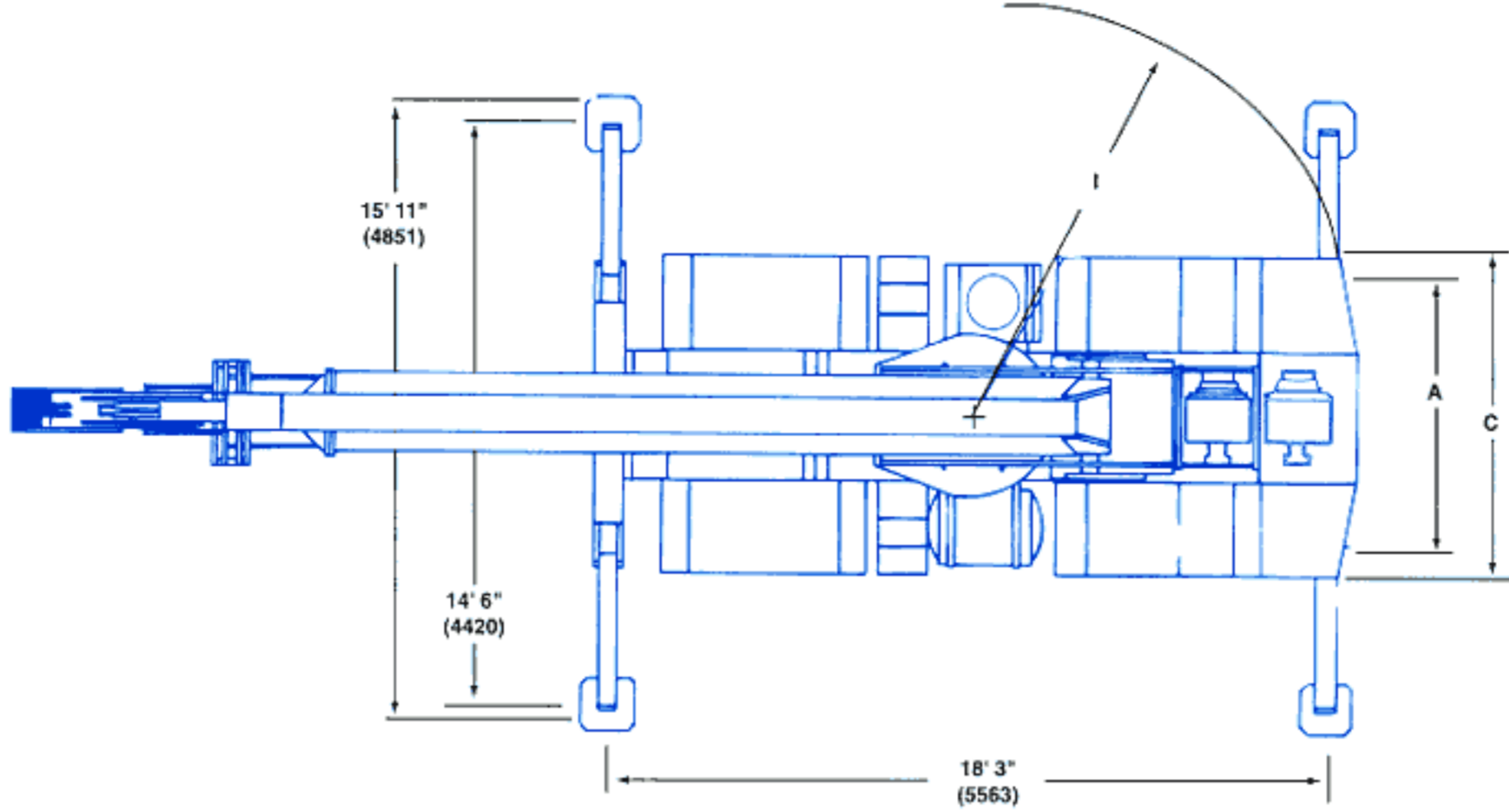

TIRE SIZE	17.5 X 25	20.5 X 25
A (TRACK)	6' 6" (1981)	6' 9" (2057)
B (O.A.H)	10' 5" (3175)	10' 9" (3277)
C (O.A.W)	8' (2438)	8' 9" (2667)
D (60' BOOM)	10' 6" (3200)	10' 9" (3277)
E (70' BOOM)	NA	11' 6" (3505)
F GROUND CLEARANCE	1' 1" (330)	1' 4" (406)
G (60' BOOM)	30' 5" (9271) w/o Aux. Hoist 32' 5" (9881) w/ Aux. Hoist	
H (70' BOOM)	35' 9" (10 896)	
I (TAILSWING)	8' 5" (2565) w/o Aux. Hoist	
(60' BOOM)	10' 3" (3124) w/ Aux. Hoist	
(70' BOOM)	10' 3" (3124)	

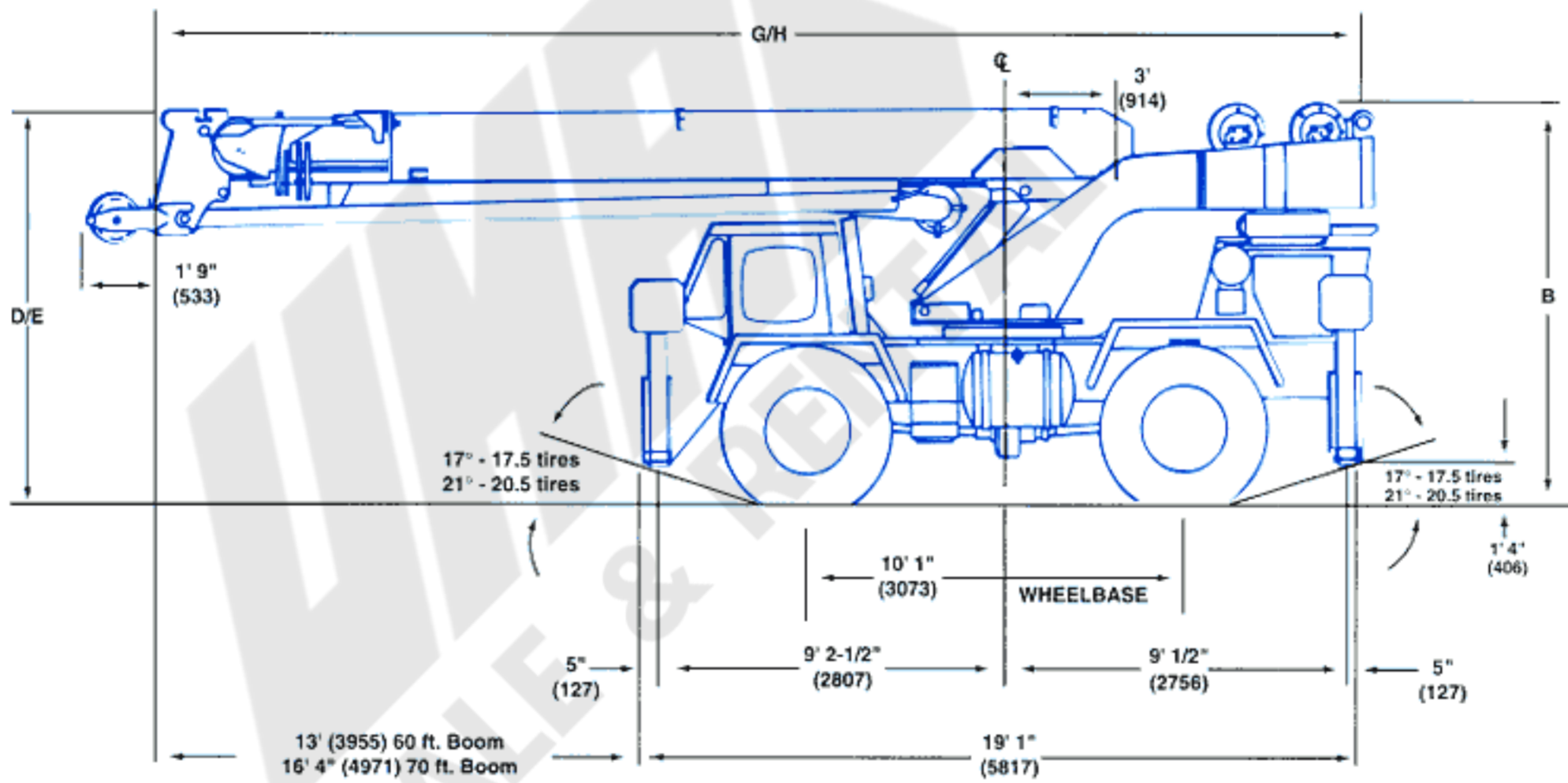

Note: () Reference dimensions in mm

- Turning Radius** 16' 3" (4940 mm)
- Front Axle Load** 20,850 lbs. (9460 kg)
- Rear Axle Load** 22,495 lbs. (10 200 kg)
- Gross Vehicle Weight** 43,345 lbs. (19 660 kg)

Working Range



25 - 60 ft.
(7.6 - 18.3 m)



20 ft.
(6.1 m)



100%



360°

FEET

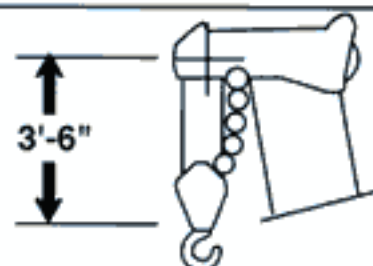
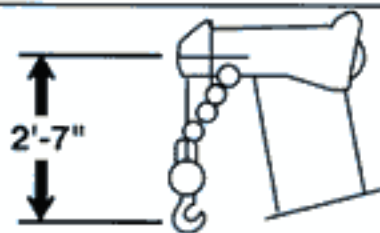
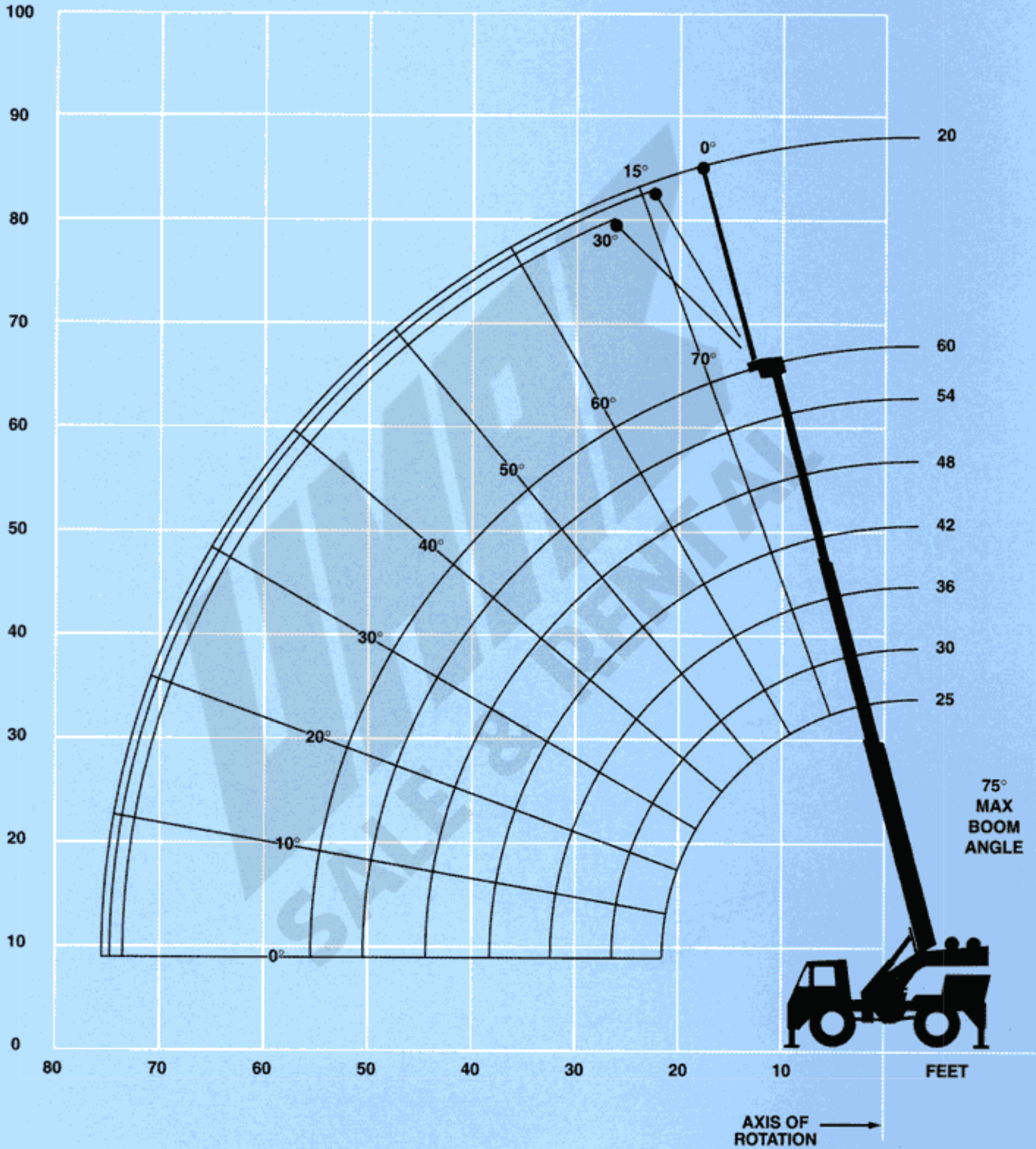

DIMENSIONS ARE FOR LARGEST GROVE FURNISHED HOOKBLOCK AND HEADACHE BALL, WITH ANTI-TWO BLOCK ACTIVATED.

Superstructure specifications

Boom

25 ft. - 60 ft. (7.6 m - 18.3 m) three-section full power boom. Maximum Tip Height: 66 ft. (20.1 m).

*Optional Jib (60 ft. Boom)

20 ft. (6.1 m) "A frame" jib offsettable at 0°, 15° or 30°. Stows beneath base boom section. Maximum Tip Height: 85 ft. (25.9 m).

*Optional Boom

28 ft.- 70 ft. (8.6 m - 21.2 m) three-section full power boom. Maximum Tip Height: 76 ft. (23.2 m).

*Optional Jib (70 ft. Boom)

23 ft. (7.0 m) "A frame" jib offsettable at 0°, 15° or 30°. Stows beneath base boom section. Maximum Tip Height: 98 ft. (29.9 m).

Boom Nose

Three steel sheaves mounted on heavy duty tapered roller bearings with removable pin-type rope guards. *Optional removable auxiliary boom nose with removable pin type rope guard.

Boom Elevation

Two double acting hydraulic cylinders with integral holding valve provides elevation from 0° to 75°.

Load Moment & Anti-Two Block System

Standard load moment and anti-two block system with audio-visual warning and control lever lockout. These systems provide electronic display of boom angle, length, radius, tip height, relative load moment, maximum permissible load, load indication and warning of impending two-block condition.

Cab

Full vision, all steel fabricated frame mounted with tinted safety glass throughout. Deluxe adjustable seat. Dash mounted control levers, gauges, for engine functions. Other standard features include: sliding side doors, electric windshield wash-wipe, circulating air fan, dome light, fire extinguisher, seat belt.

Swing

Ball bearing swing circle with 360° continuous rotation. Grove planetary drive with automatic multi-disc swing brake and plunger type mechanical house lock. Maximum speed: 2.9 RPM.

Counterweight

Bolted to turntable mast.

60 ft. (18.3 m) Boom:

With main only: 7,470 lbs. (3388 kg)

With main & aux.: 5,710 lbs. (2590 kg)

70 ft. (21.2 m) Boom:

All configurations: 10,170 lbs. (4613 kg)

Hydraulic System

Three main pumps with a combined capacity 112.5 GPM (426 LPM). Driven by carrier engine through P.T.O. Maximum operating pressure: 2500 PSI (172 BAR). *Optional pump disconnect with engine jogging switch.

Hoist Specifications

Main and *Auxiliary Hoist

Power up and down equal speed, grooved drum, planetary reduction with automatic brake and hoist cable followers. Electronic hoist drum rotation indicators and wire rope.

Maximum Single Line Pull: 9,640 lbs. (4372 kg)

Maximum Single Line Speed: 429 FPM (131 m/min)

Maximum Permissible Line Pull: 8,496 lbs. (3853 kg)

Rope Diameter: 5/8 in. (16 mm)

Rope Length: 350 ft. (106 m)

Maximum Rope Stowage: 486 ft. (148 m)

Carrier specifications

Chassis

Steel all welded box-type construction. Integral outrigger housings and front/rear towing and tie down lugs.

Outrigger System

Cantilever arm type at all four corners with integral check valves on each extension cylinder. Integral all steel outrigger float pads 13.5 in. (343 mm) square. Maximum outrigger pad load: 36,787 lbs. (16 687 kg).

Outrigger Controls

Controls and crane level indicator located in cab.

Engine

Cummins 6BT5.9L six cylinders, turbocharged, water cooled diesel, 130 bhp (97 kW) (Gross) @ 2,500 RPM. Maximum torque: 386 ft. lbs. (523 Nm) @ 1,400 RPM.

Fuel Tank Capacity

60 gallons (227 L).

Transmission

Remote mounted powershift with 6 forward and 6 reverse speeds, 3 in high range, 3 in low range. Rear axle disconnect for 4 x 2 travel.

Electrical System

Two 12 V - maintenance free batteries. 625 CCA@ 0°F 12 V starting.

Drive

4 x 4 or 4 x 2.

Steering

Fully independent power steering:
Front: Full hydraulic steering wheel controlled.
Rear: Full hydraulic tiller bar controlled.
Provides infinite variations of 4 main steering modes: front only, rear only, crab and coordinated.
Rear steer indicating gauge.

Axles

Front: Drive steer with differential and planetary reduction hubs rigid mounted to chassis.
Rear: Drive/steer with differential and planetary reduction hubs pivot mounted at center of chassis. Automatic full hydraulic lockouts on rear axle. *No-spin differential on rear axle.

Oscillation Lockouts

Automatic full hydraulic lockouts on rear axle permits oscillation only with boom centered over the front.
*Oscillation lockout override control.

Tires

Std. 17.5 x 25 - 20PR earthmover type, tubeless.
*Optional: 20.5 x 25 -20PR, earthmover type, tubeless.

Lights

Full lighting including turn indicators, head, tail, brake, and hazard warning lights.

Maximum Speed

24 MPH (38.0 kph).

Gradeability (Theoretical)

96.7% (Theoretical based 49,000 lbs. [22 226 kg] GVW)

Miscellaneous Standard Equipment

Full width steel fenders, electronic back-up alarm, light package, hourmeter, fire extinguisher, seat belts, air cleaner service indicator.

*Optional Equipment

- *Auxiliary hoist w/wire rope
- *Boom mounted worklights
- *360° flashing light
- *Spotlights
- *Hot water heater
- *Hookblock/Headache ball
- *Tow winch - front mounted maximum pull: 15,000 lbs. (6804 kg); maximum speed: 72 ft/min. (22 m/min).
- *Spare wheel
- *Tool kit
- *LMI light bar
- *Cold start aid (less canister)
- *Tachometer
- *A/V warning system, low oil pressure, high water temperature.
- *360° positive swing lock
- *Integral toolboxes

**Denotes optional equipment*



25 - 60 ft.
(7.6 - 18.3 m)



7,470 lbs.
(3388 kg)



100%



360°



(Feet)	25	30	36	42	48	54	60
12	30,000 (54.5)	30,000 (62)	30,000 (67.5)	30,000 (71)	30,000 (74)		
15	28,000 (45)	28,000 (55)	28,000 (62)	28,000 (66.5)	28,000 (70)	27,600 (73)	25,000 (75.5)
20	19,600 (23.5)	19,600 (41.5)	19,600 (52)	19,600 (59)	19,600 (63.5)	19,600 (67.5)	19,600 (70.5)
25		13,300 (23)	13,300 (41)	13,300 (50.5)	13,300 (56.5)	13,300 (61.5)	13,300 (65)
30			9,730 (25.5)	9,730 (40.5)	9,730 (49)	9,730 (55)	9,730 (59.5)
35				7,440 (27.5)	7,440 (40)	7,440 (48)	7,440 (53.5)
40					5,880 (28.5)	5,880 (40)	5,880 (47)
45						4,820 (30)	4,820 (39.5)
50						4,000 (13.5)	4,000 (30)
55							3,350 (16.5)

Minimum boom angle (degrees) for indicated length (no load)

0

Maximum boom length (ft.) at 0 degree boom angle (no load)

60

Note: () Boom angles are in degrees.

Boom Angle	25	30	36	42	48	54	60
0°	15,150 (21.8)	11,550 (27)	8,250 (33)	6,140 (39)	4,820 (45)	3,850 (51)	2,970 (56.6)

A6-829-003395 & -003404E



25 - 60 ft.
(7.6 - 18.3 m)

7,470 lbs.
(3388 kg)

100%

Over Front



(Pounds)

(Feet)	25	30	36	42	48	54	60
12	30,000 (54.5)	30,000 (62)	30,000 (67.5)	30,000 (71)	30,000 (74)		
15	28,000 (45)	28,000 (55)	28,000 (62)	28,000 (66.5)	28,000 (70)	27,600 (73)	25,000 (75.5)
20	22,200 (23.5)	22,200 (41.5)	22,200 (52)	22,200 (59)	22,200 (63.5)	21,900 (67.5)	21,500 (70.5)
25		17,400 (23)	17,400 (41)	17,400 (50.5)	17,400 (56.5)	17,400 (61.5)	17,400 (65)
30			14,100 (25.5)	14,100 (40.5)	14,100 (49)	14,100 (55)	14,100 (59.5)
35				11,320 (27.5)	11,320 (40)	11,320 (48)	11,320 (53.5)
40					9,010 (28.5)	9,010 (40)	9,010 (47)
45						7,470 (30)	7,470 (39.5)
50						6,200 (13.5)	6,200 (30)
55							5,100 (16.5)

Minimum boom angle (degrees) for indicated length (no load)

0

Maximum boom length (ft.) at 0 degree boom angle (no load)

60

Note: () Boom angles are in degrees.

A6-829-003393 & -003404E



25 - 60 ft.
(7.6 - 18.3 m)



20 ft.
(6.1 m)



7,470 lbs.
(3388 kg)



100%



360°



(Pounds)

Boom Angle	0° OFFSET	15° OFFSET	30° OFFSET
75	9,500 (21.5)	6,100 (25.8)	4,200 (28.9)
70	8,400 (27.8)	5,450 (31.9)	3,870 (34.8)
65	7,140 (33.9)	4,850 (37.8)	3,660 (40.5)
60	5,440 (39.7)	4,400 (43.4)	3,500 (45.9)
55	4,210 (45.3)	3,770 (48.6)	3,330 (50.8)
50	3,410 (50.5)	3,200 (53.6)	3,200 (55.4)
45	2,810 (55.2)	2,730 (58.1)	2,700 (59.6)
40	2,440 (59.6)	2,360 (62.1)	2,360 (63.2)
35	2,150 (63.5)	2,040 (65.6)	2,040 (66.4)
30	1,890 (66.9)	1,810 (68.6)	1,810 (69.1)

NOTE: () Reference radii in feet.

A6-829-003405C

WINDY
SALE & RENTAL



25 - 60 ft.
(7.6 m - 18.3 m)

7,470 lbs.
(3388 kg)

Stationary
17.5 X 25 - 20PR Tires

360°



(Pounds)

(Feet)	25	30	36	42	48	54
10	16,280 (60)					
12	13,000 (54.5)	10,000 (62)	10,000 (67.5)	10,000 (71)	10,000 (74)	
15	9,000 (45)	7,600 (55)	7,600 (62)	7,600 (66.5)	7,600 (70)	
20	5,290 (23.5)	5,000 (41.5)	5,000 (52)	5,000 (59)	5,000 (63.5)	5,000 (67.5)
25		3,440 (23)	3,440 (41)	3,440 (50.5)	3,440 (56.5)	3,440 (61.5)
30			2,440 (25.5)	2,440 (40.5)	2,440 (49)	2,440 (55)
35				1,780 (27.5)	1,700 (40)	1,700 (48)
40					1,220 (28.5)	1,100 (40)
45						820 (30)
Boom Angle	25	30	36	42		
0°	4,560 (21.8)	2,950 (27)	2,030 (33)	1,320 (39)		

A6-829-009191A



25 - 60 ft.
(7.6 - 18.3 m)



7,470 lbs.
(3388 kg)



Stationary
17.5 X 25 - 20PR Tires



Defined Arc
Over Front
±6°



(Feet)	25	30	36	42	48	54	60
10	24,100 (60)						
12	22,060 (54.5)	16,000 (62)	16,000 (67.5)	16,000 (71)	10,000 (74)		
15	17,380 (45)	13,000 (55)	13,000 (62)	13,000 (66.5)	10,000 (70)		
20	11,340 (23.5)	9,600 (41.5)	9,600 (52)	9,600 (59)	9,600 (63.5)	9,600 (67.5)	
25		7,650 (23)	7,650 (41)	7,500 (50.5)	7,500 (56.5)	7,500 (61.5)	
30			5,660 (25.5)	5,660 (40.5)	5,660 (49)	5,660 (55)	5,660 (59.5)
35				4,340 (27.5)	4,340 (40)	4,340 (48)	4,340 (53.5)
40					3,410 (28.5)	3,410 (40)	3,410 (47)
45						2,750 (30)	2,750 (39.5)
50						2,180 (13.5)	2,150 (30)
55							1,600 (16.5)

NOTE: () Boom angles are in degrees.

Boom Angle	25	30	36	42	48	54	60
0°	9,880 (21.8)	6,680 (27)	4,820 (33)	3,570 (39)	2,750 (45)	2,060 (51)	1,480 (56.6)

A6-829-009166A



25 - 60 ft.
(7.6 m - 18.3 m)



7,470 lbs.
(3388 kg)



Pick & carry
Up to 2.5 MPH
17.5 X 25 - 20PR Tires



Boom Centered
Over Front



(Feet)	25	30	36	42	48	54	60
10	24,750 (60)						
12	21,030 (54.5)	13,700 (62)	13,700 (67.5)				
15	16,830 (45)	11,100 (55)	11,100 (62)	11,100 (66.5)	11,100 (70)		
20	11,340 (23.5)	8,670 (41.5)	8,670 (52)	8,300 (59)	8,300 (63.5)		
25		7,650 (23)	7,650 (41)	6,400 (50.5)	6,400 (56.5)	6,400 (61.5)	
30			5,410 (25.5)	5,000 (40.5)	5,000 (49)	5,000 (55)	5,000 (59.5)
35				4,340 (27.5)	4,000 (40)	4,000 (48)	4,000 (53.5)
40					3,410 (28.5)	3,100 (40)	3,100 (47)
45						2,750 (30)	2,500 (39.5)
50						2,180 (13.5)	2,000 (30)
55							1,600 (16.5)

NOTE: () Boom angles are in degrees.

Boom Angle	25	30	36	42	48	54	60
0°	9,880 (21.8)	5,990 (27)	4,750 (33)	3,570 (39)	2,750 (45)	2,060 (51)	1,480 (56.6)

A6-829-009192A

Working Range



28 - 70 ft.
(8.6 - 21.2 m)



23 ft.
(7.0 m)



100%



360°

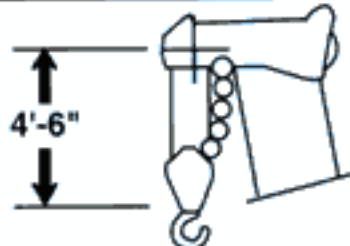
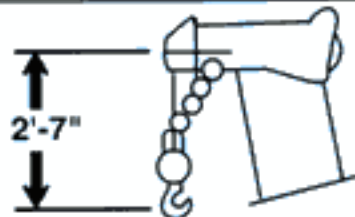
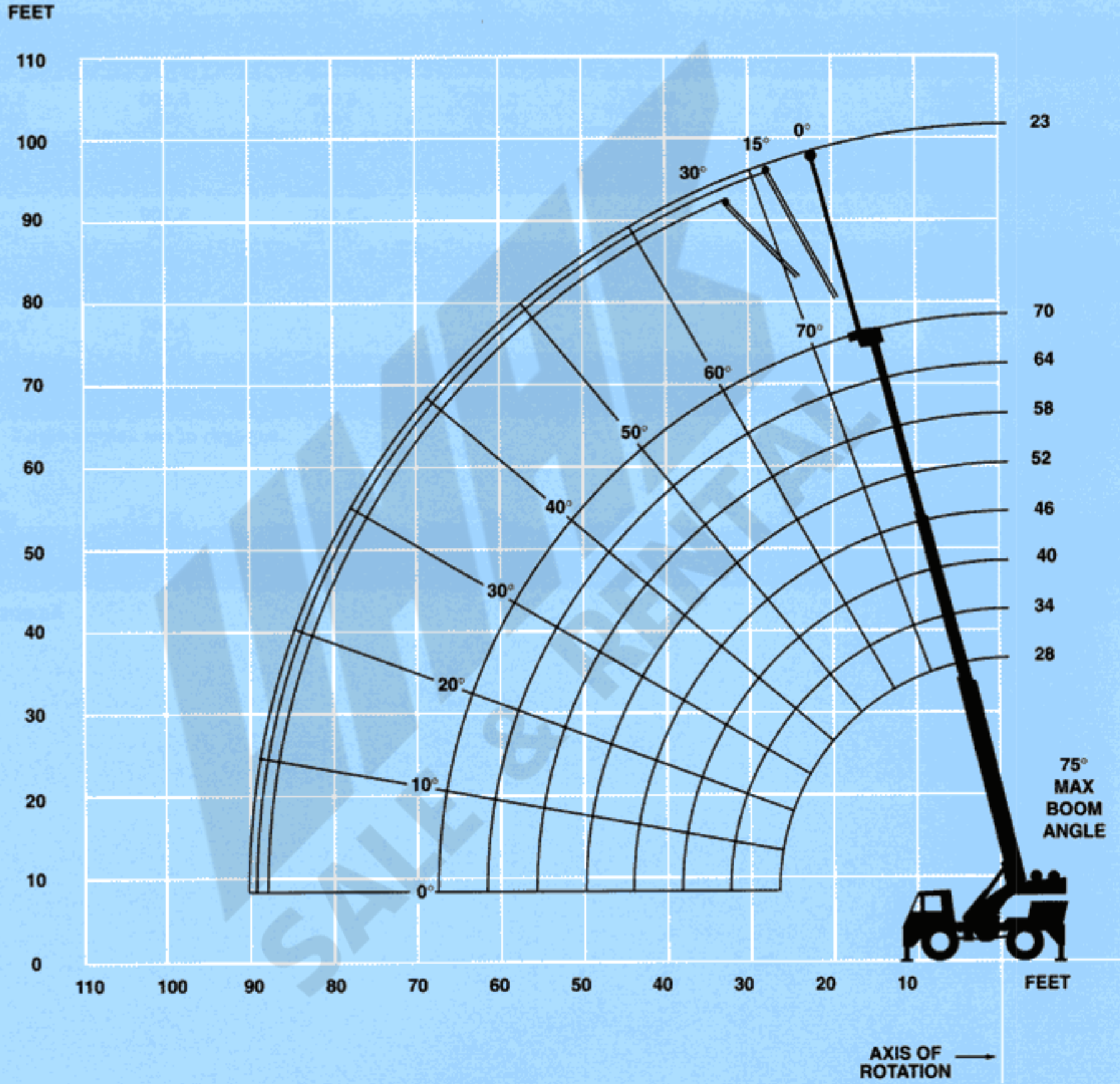

DIMENSIONS ARE FOR LARGEST GROVE FURNISHED HOOKBLOCK AND HEADACHE BALL, WITH ANTI-TWO BLOCK ACTIVATED.



28 - 70 ft.
(8.6 - 21.2 m)



10,170 lbs.
(4613 kg)



100%



360°



(Feet)	28	34	40	46	52	58	64	70
12	30,000 (59.5)	30,000 (65.5)	30,000 (70)	29,250 (73)				
15	27,100 (51.5)	26,100 (59.5)	25,200 (65)	24,500 (69)	23,950 (72)	23,500 (74.5)		
20	21,000 (36.5)	20,600 (49)	19,950 (57)	19,350 (62)	18,850 (66)	18,400 (69.5)	18,050 (72)	17,750 (74)
25		15,450 (36)	15,450 (47.5)	15,450 (54.5)	15,450 (60)	15,100 (64)	14,800 (67)	14,520 (69.5)
30			11,270 (36.5)	11,270 (46.5)	11,270 (53)	11,270 (58)	11,270 (62)	11,270 (65)
35				8,660 (36.5)	8,660 (45.5)	8,660 (51.5)	8,660 (56.5)	8,660 (60)
40					6,940 (36.5)	6,940 (45)	6,940 (50.5)	6,940 (55)
45						5,550 (37)	5,550 (44.5)	5,550 (49.5)
50							4,500 (37)	4,500 (43.5)
55							3,600 (28)	3,600 (37)
60								2,850 (28.5)
65								2,260 (15.5)
Minimum boom angle (degrees) for indicated length (no load)								0
Maximum boom length (ft.) at 0 degree boom angle (no load)								70
Note: () Boom angles are in degrees.								

Boom Angle	28	34	40	46	52	58	64	70
0°	11,900 (25.1)	9,230 (31)	7,320 (37)	5,920 (43)	4,690 (49)	3,600 (55)	2,710 (61)	2,110 (66.6)

A6-829-004343A & -003716H

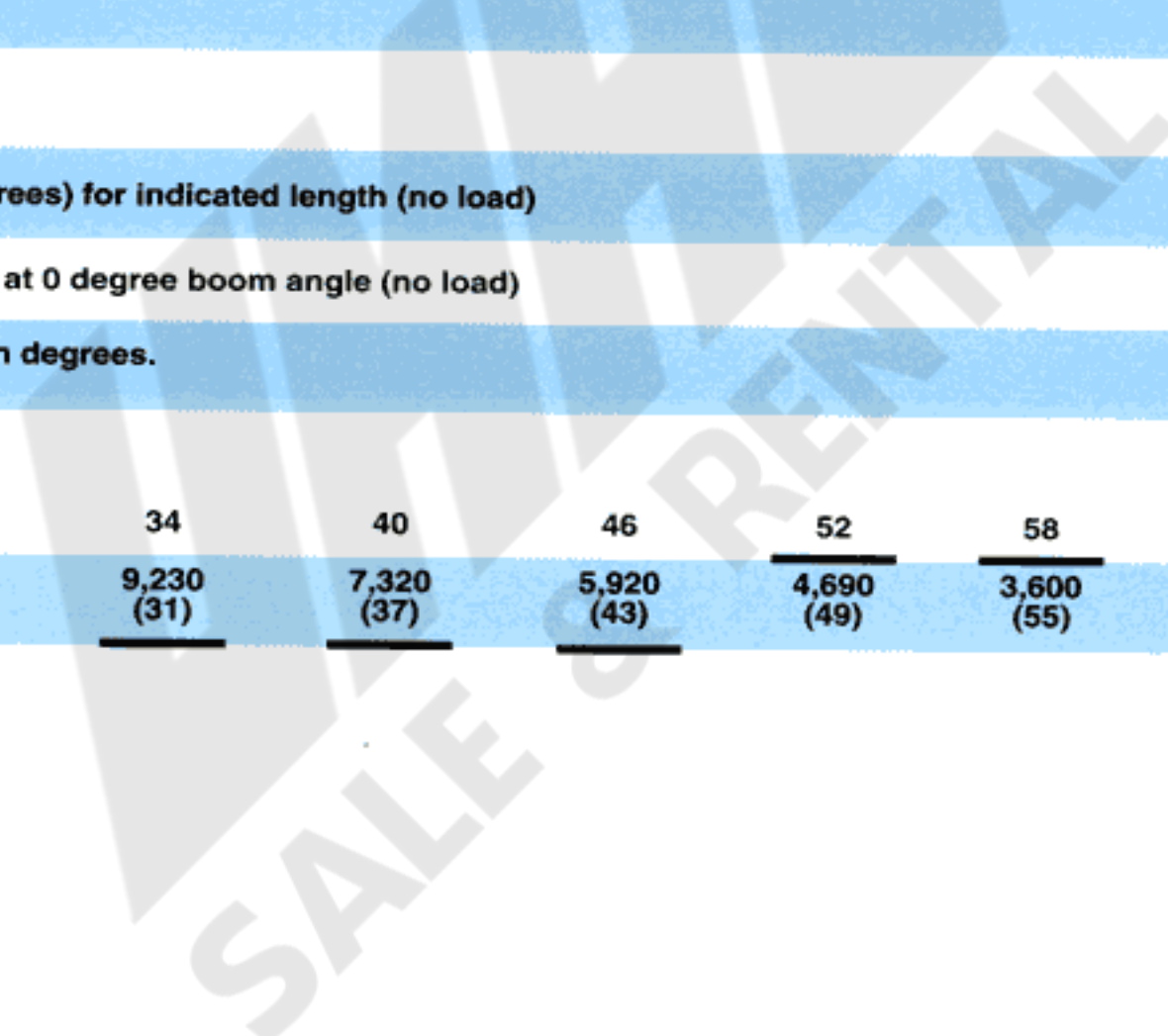



28 - 70 ft.
(8.6 - 21.2 m)



10,170 lbs.
(4613 kg)



100%



Over Front



(Feet)	28	34	40	46	52	58	64	70
12	30,000 (59.5)	30,000 (65.5)	30,000 (70)	29,250 (73)				
15	27,100 (51.5)	26,100 (59.5)	25,200 (65)	24,500 (69)	23,950 (72)	23,500 (74.5)		
20	21,000 (36.5)	20,600 (49)	19,950 (57)	19,350 (62)	18,850 (66)	18,400 (69.5)	18,050 (72)	17,750 (74)
25		16,600 (36)	16,350 (47.5)	15,900 (54.5)	15,500 (60)	15,100 (64)	14,800 (67)	14,520 (69.5)
30			13,530 (36.5)	13,350 (46.5)	13,050 (53)	12,750 (58)	12,450 (62)	12,200 (65)
35				11,250 (36.5)	11,150 (45.5)	10,950 (51.5)	10,700 (56.5)	10,500 (60)
40					9,540 (36.5)	9,480 (45)	9,320 (50.5)	9,140 (55)
45						8,160 (37)	8,140 (44.5)	8,020 (49.5)
50							6,870 (37)	6,870 (43.5)
55							5,740 (28)	5,740 (37)
60								4,770 (28.5)
65								3,910 (15.5)
Minimum boom angle (degrees) for indicated length (no load)								0
Maximum boom length (ft.) at 0 degree boom angle (no load)								70
Note: () Boom angles are in degrees.								

A6-829-004339A & -003716H



28 - 70 ft.
(8.6 - 21.2 m)



23 ft.
(7.0 m)



10,170 lbs.
(4613 kg)



100%



360°



(Pounds)

Boom Angle	0° OFFSET	15° OFFSET	30° OFFSET
75	12,000 (27)	7,700 (32.5)	5,070 (35.7)
70	8,160 (33.3)	7,000 (38.1)	4,800 (41.2)
65	5,680 (40.2)	5,350 (44.9)	4,500 (47.8)
60	4,310 (47)	4,220 (51.3)	3,620 (54)
55	3,330 (53.2)	3,300 (57.3)	2,940 (59.8)
50	2,720 (59.2)	2,580 (62.9)	2,390 (65.1)
45	2,210 (64.7)	2,130 (68)	2,010 (69.9)
40	1,750 (69.6)	1,690 (72.6)	1,680 (74.2)
35	1,460 (74)	1,420 (76.6)	1,420 (77.9)
30	1,240 (77.8)	1,210 (80.1)	1,200 (81.0)

NOTE: () Reference radii in feet.

A6-829-004378D

WINDY
SALE & RENTAL



28 - 70 ft.
(8.6 - 21.2 m)



10,170 lbs.
(4613 kg)



Stationary
20.5 X 25 - 20PR Tires



360°



(Feet)	28	34	40	46	52	58	64
10	24,710 (64)	15,000 (69)	14,500 (73)				
12	18,450 (59.5)	13,500 (65.5)	12,100 (70)	12,100 (73)			
15	12,610 (51.5)	12,100 (59.5)	9,450 (65)	9,450 (69)	9,450 (72)		
20	7,290 (36.5)	7,290 (49)	6,350 (57)	6,100 (62)	6,100 (66)	6,100 (69.5)	6,100 (72)
25	4,780 (6)	4,780 (36)	4,780 (47.5)	4,250 (54.5)	4,250 (60)	4,250 (64)	4,250 (67)
30		3,350 (15.5)	3,350 (36.5)	3,350 (46.5)	3,000 (53)	3,000 (58)	3,000 (62)
35			2,410 (20)	2,410 (36.5)	2,410 (45.5)	2,050 (51.5)	2,050 (56.5)
40				1,690 (23)	1,690 (36.5)	1,690 (45)	1,300 (50.5)
45					1,050 (25)	1,050 (37)	1,050 (44.5)
Boom Angle	28	34	40	46			
0°	4,750 (25.1)	3,120 (31)	2,110 (37)	1,300 (43)			

A6-829-009270



28 - 70 ft.
(8.6 - 21.2 m)



10,170 lbs.
(4613 kg)



Stationary
20.5 X 25 - 20PR Tires



Defined Arc
Over Front
±6°



(Feet)	28	34	40	46	52	58	64	70
10	30,000 (64)	20,500 (69)	18,500 (73)					
12	27,500 (59.5)	18,500 (65.5)	16,500 (70)	16,500 (73)				
15	22,300 (51.5)	16,500 (59.5)	14,000 (65)	14,000 (69)	14,000 (72)			
20	13,940 (36.5)	13,940 (49)	10,500 (57)	10,500 (62)	10,500 (66)	10,500 (69.5)	10,500 (72)	
25	9,160 (6)	9,160 (36)	8,000 (47.5)	8,000 (54.5)	8,000 (60)	8,000 (64)	8,000 (67)	
30		6,850 (15.5)	6,850 (36.5)	6,250 (46.5)	6,250 (53)	6,250 (58)	6,250 (62)	6,250 (65)
35			5,180 (20)	5,180 (36.5)	4,950 (45.5)	4,950 (51.5)	4,950 (56.5)	4,950 (60)
40				4,020 (23)	4,020 (36.5)	3,900 (45)	3,900 (50.5)	3,900 (55)
45					3,140 (25)	3,140 (37)	3,050 (44.5)	3,050 (49.5)
50						2,430 (26.5)	2,430 (37)	2,350 (43.5)
55						1,860 (3.5)	1,860 (28)	1,750 (37)
60							1,440 (13)	1,440 (28.5)
65								1,140 (15.5)
Boom Angle	28	34	40	46	52	58	64	70
0°	9,120 (25.1)	6,460 (31)	4,670 (37)	3,470 (43)	2,560 (49)	1,860 (55)	1,400 (61)	990 (66.6)

A6-829-009272



28 - 70 ft.
(8.6 - 21.2 m)



10,170 lbs.
(4613 kg)



Pick & carry
Up to 2.5 MPH
20.5 X 25 - 20PR Tires



Boom Centered
Over Front



(Pounds)

(Feet)	28	34	40	46	52	58	64
10	28,470 (64)	18,000 (69)	18,000 (73)				
12	24,550 (59.5)	15,500 (65.5)	15,500 (70)	15,500 (73)			
15	20,420 (51.5)	12,500 (59.5)	12,500 (65)	12,500 (69)	12,500 (72)		
20	13,940 (36.5)	10,500 (49)	8,500 (57)	8,500 (62)	8,500 (66)	8,500 (69.5)	8,500 (72)
25	9,160 (6)	9,160 (36)	6,500 (47.5)	6,500 (54.5)	6,500 (60)	6,500 (64)	6,500 (67)
30		5,670 (15.5)	5,670 (36.5)	4,950 (46.5)	4,950 (53)	4,950 (58)	4,950 (62)
35			4,430 (20)	4,430 (36.5)	3,900 (45.5)	3,900 (51.5)	3,900 (56.5)
40				3,510 (23)	3,050 (36.5)	3,050 (45)	3,050 (50.5)
45					2,760 (25)	2,350 (37)	2,350 (44.5)
50						2,120 (26.5)	1,750 (37)
55						1,580 (3.5)	1,580 (28)
60							1,180 (13)

Note: () Boom angles are in degrees.

A6-829-009271

WALSH
SALE & RENTAL

WEIGHT REDUCTIONS FOR LOAD HANDLING DEVICES

20 FT. A-FRAME BOOM EXTENSION WITH 25' - 60' BOOM

*Stowed -	248 lbs.
*Erected -	1,375 lbs.

*Reduction of main boom capacities

AUXILIARY BOOM HEAD 100 lbs.

HOOKBLOCKS and HEADACHE BALLS:

12 Ton, 1 Sheave	268 lbs.+
15 Ton, 2 Sheave	290 lbs.+
22 Ton, 3 Sheave	455 lbs.+
7 -1/2 Ton Headache Ball	338 lbs.+
5 Ton Headache Ball	172 lbs.+

+Refer to rating plate for actual weight.

23 FT. A-FRAME BOOM EXTENSION WITH 28' - 70' BOOM

*Stowed -	381 lbs.
*Erected -	1,950 lbs.

*Reduction of main boom capacities

AUXILIARY BOOM HEAD 100 lbs.

HOOKBLOCKS and HEADACHE BALLS:

12 Ton, 1 Sheave (12-1/8" OD)	268 lbs.+
12 Ton, 1 Sheave (15-7/8" OD)	360 lbs.+
22 Ton, 3 Sheave	455 lbs.+
7 -1/2 Ton Headache Ball	338 lbs.+
5 Ton Headache Ball	172 lbs.+

+Refer to rating plate for actual weight.

NOTES:

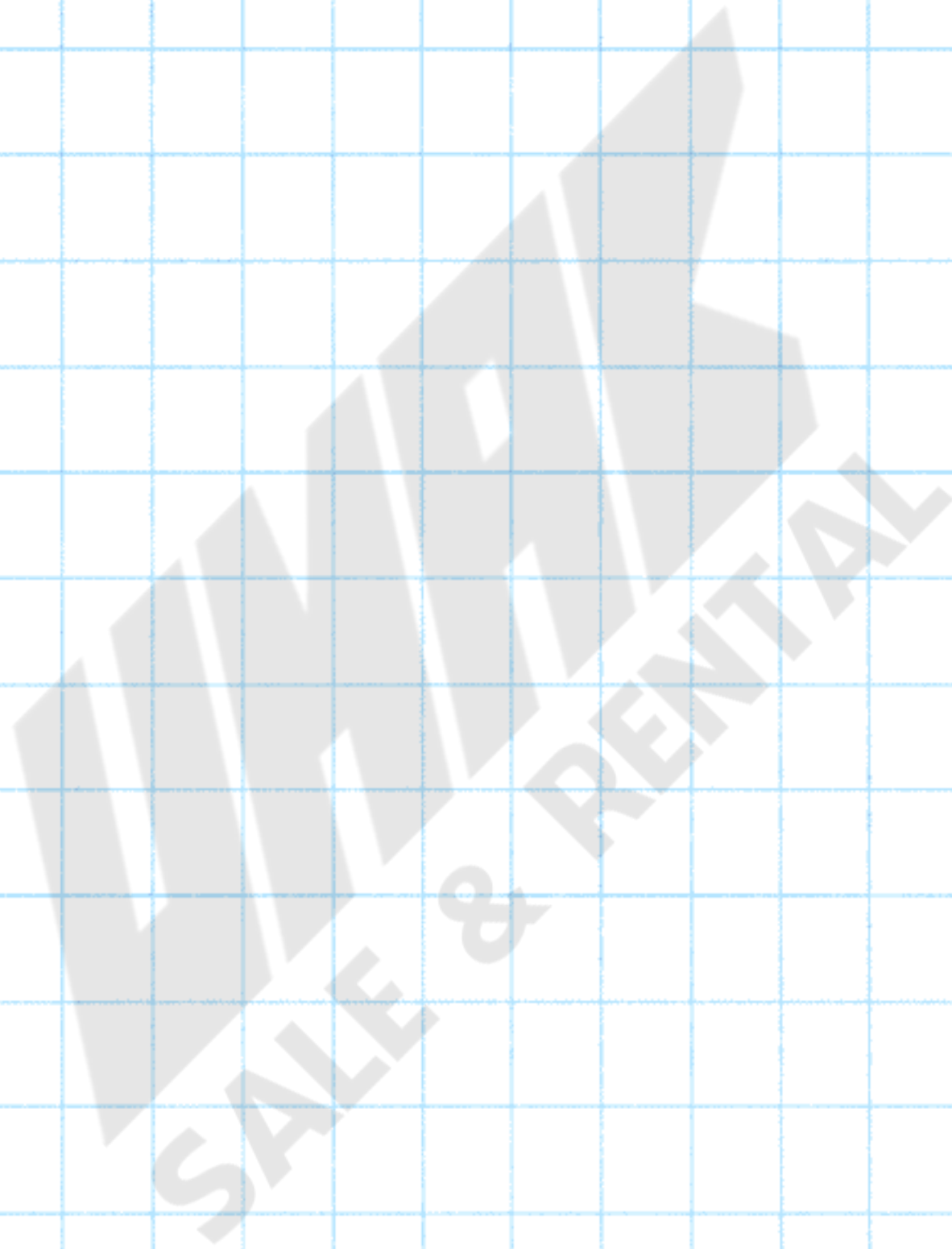















Rated lifting capacities

Important Notes:

Warning: THIS CHART IS ONLY A GUIDE.
 The notes below are for illustration only and should not be relied upon to operate the crane. The individual crane's load chart, operating instructions and other instruction plates must be read and understood prior to operating the crane.

1. All rated loads have been tested to and meet minimum requirements of SAE J1063 NOV95- Cantilevered Boom Crane Structures - Method of Test, and do not exceed 85% of the tipping load on outriggers (75% of the tipping load on rubber) as determined by SAE J765 OCT90 Crane Stability Test Code.
2. Capacities given do not include the weight of hook-blocks, slings, auxiliary lifting equipment and load handling devices. Their weights must be added to the load to be lifted. When more than minimum required reeving is used, the additional rope weight shall be considered part of the load.
3. Capacities appearing above the bold line are based on structural strength. Tipping should never be used to indicate capacity limitation.
4. All capacities are for crane on firm, level surface. It may be necessary to have structural supports under the outrigger floats or tires to spread the load to a larger bearing surface.
5. When either boom length or radius or both are between values listed, the smallest load shown at either the next larger radius or boom length shall be used.
6. For outrigger operation, ALL outriggers shall be fully extended with tires raised free of ground before raising the boom or lifting loads.

Symbols Glossary

	Frame		Steering
	Outriggers		Transmission
	Outrigger Controls		Axles
	Engine		Brakes
	Fuel Tank Capacity		Tires
	Electrical System		Suspension
	Drive		Rotation
	Lights		Boom Elevation
	Cab		Swing
	Boom		Counterweight
	Fixed Swingaway		Oil
	Tele-Swingaway		Hydraulic System
	Jib		Hoist
	Boom Nose		Radius
	Boom Extension		Boom Length
	Speed		Hookblock
	Grade		Gear
	Lattice Extension		Luffing Jib

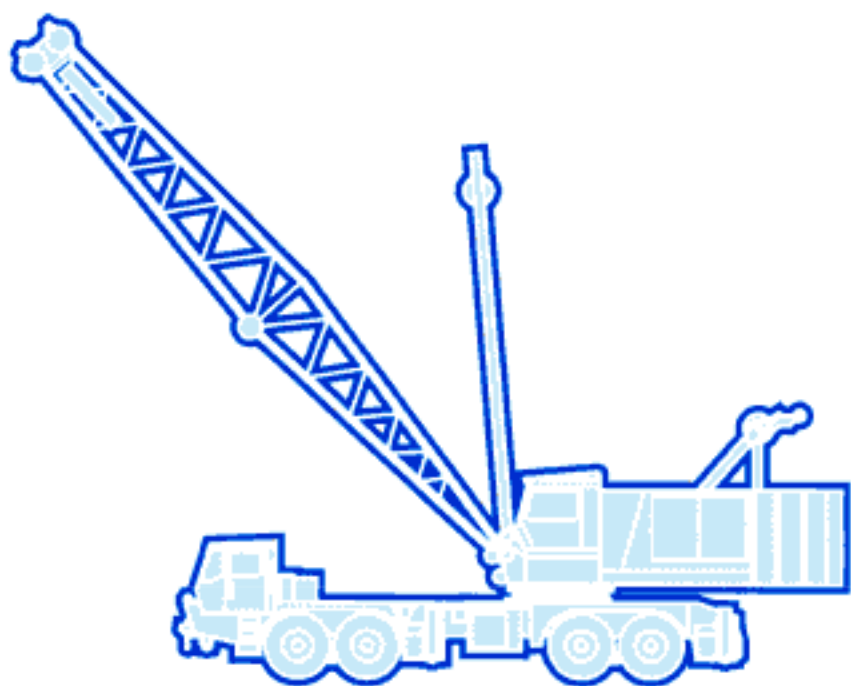

Grove Worldwide – World Headquarters

Grove North America
1565 Buchanan Trail East
P.O. Box 21
Shady Grove, Pennsylvania 17256, U.S.A.
Tel: [Int + 1] (717) 597-8121
Fax: [Int + 1] (717) 597-4062
Western Hemisphere, Asia/Pacific

Grove France S.A.

16, chaussée Jules-César, 95520 OSNY
B.P. 203, 95523 CERGY PONTOISE CEDEX
France
Tel: [Int + 33] (1) 30313150
Int: [Int + 33] (1) 30386085



Grove Europe Limited*

Sunderland SR4 6TT, England
Tel: [Int + 44] 191 565-6281
Fax: [Int + 44] 191 564-0442
Europe, Africa, Middle East

Grove Asia/Pacific - Regional Office

171 Chin Swee Road
#06-01 San Centre
Singapore 0316
Tel: [Int + 65] 536-6112
Fax: [Int + 65] 536-6119
Asia/Pacific, Near East



Grove Europe Limited*

P.O. Box No. 268
4A Kimber Road
Abingdon, Oxfordshire, OX141SG
Tel: [Int + 44] 1235 55-3184
Fax: [Int + 44] 1235 55-3218
*Grove Europe Limited, Registered in England,
Number 1845128, Registered office, Crown Works,
Pallion, Sunderland, Tyne & Wear, England SR4 6TT

Grove China - Representative Office

Beijing Suite 6074
No. 33 East Chang An Avenue
Beijing, 100004, China
Tel: [Int + 86] (10) 513-7766
Fax: [Int + 86] (10) 513-7307



Deutsche Grove GmbH

Sales and Service
Helmholtzstrasse 12, Postfach 5026
D-40750 Langenfeld, Germany
Tel: [Int + 49] (2173) 8909-0
Fax: [Int + 49] (2173) 8909-30

Grove Product Support

Western Hemisphere, Asia/Pacific
1086 Wayne Avenue
Chambersburg, Pennsylvania USA
Tel: [Int + 1] (717) 263-5100
Fax: [Int + 1] (717) 267-0404



Wilhelmshaven Works

Industriegelände West, Postfach 1853
D-26358 Wilhelmshaven, Germany
Tel: [Int + 49] (4421) 294-0
Fax: [Int + 49] (4421) 294-301

Europe, Africa, Middle East
Sunderland SR4 6TT, England
Tel: [Int + 44] 191 565-6281
Parts Fax: [Int + 44] 191 510-9242
Service Fax: [Int + 44] 191 510-9560



<http://www.groveworldwide.com>



Constant improvement and engineering progress make it necessary that we reserve the right to make specification, equipment, and price changes without notice. Illustrations shown may include optional equipment and accessories and may not include all standard equipment.

Distributed By: