

GROVE®

RT535E

product guide

features

- 35 ton (35 mt) capacity
- 32-102 ft. (9.8-31.0 m) 4-section full power boom
- 26-45 ft. (7.6-13.7 m) offsettable telescopic swingaway extension
- Dual-Axis electric joystick controllers
- Full frame decking
- NEW cab design
- 155 hp Cummins diesel engine



contents

Features

2

Specifications

3

Dimensions

5

Working Range

6

Load Charts

7

Load Handling

13

features

2



The RT535E incorporates a rectangular boom shape made from 100k.s.i. steel which eliminates weight and improves capacity compared to conventional shapes.



Rounded steel cab design provides aesthetic appeal.

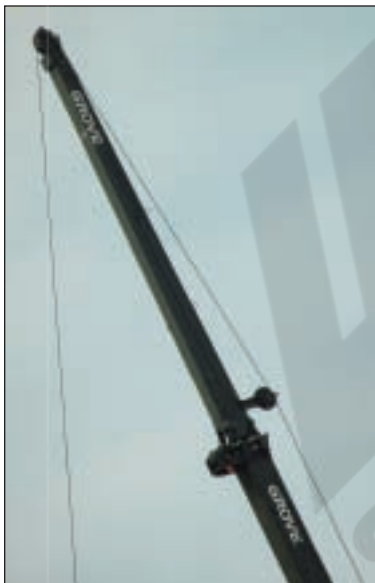

Max. tip height of 154 ft. (47.0 m)
w/45 ft. (13.7 m) tele. extension



New look dash control panel designed to offer a less cluttered look while still offering full instrumentation.



Cummins QSB 5.9L diesel engine provides plenty of power at the jobsite.

specifications

3

Superstructure



Boom

32 ft. - 102 ft. (9.8 m - 31.0 m) four-section, synchronized full power boom. Maximum tip height: 110 ft. (33.6 m).



*Optional Fixed Swingaway Extension

26 ft. (7.9 m) offsettable swingaway extension. Offsets 0° and 30°. Stows alongside base boom section. Maximum tip height: 135 ft. (41.1 m).



*Optional Telescopic Swingaway Extension

26 ft. - 45 ft. (7.9 m - 13.7 m) offsettable telescoping swingaway extension. Offsets at 0° and 30°. Stows alongside base boom section.

Maximum tip height: 154 ft. (47.0 m).



Boom Nose

Four nylatron sheaves mounted on heavy duty tapered roller bearings with removable pin-type rope guards. Quick reeve type boom nose.



Boom Elevation

One double-acting hydraulic cylinder with integral holding valve provides elevation from -3° to +78°.



Load Moment & Anti-Two Block System

Standard "Graphic Display" load moment and anti-two block system with audio-visual warning and control lever lockout. These systems provide electronic display of boom angle, length, radius, tip height, relative load moment, maximum permissible load, load indication and warning of impending two-block condition. The standard Work Area Definition System allows the operator to pre-select and define safe working areas. If the crane approaches the pre-set limits, audio-visual warnings aid the operator in avoiding job-site obstructions.



Cab

Full-vision, all-steel fabricated with acoustical lining and tinted safety glass throughout. Deluxe seat incorporates armrest mounted electric dual-axis controllers. Dash panel incorporates gauges for all engine functions. Other standard features include: tilt steering wheel, hot water heater, cab circulating air fan, sliding side and rear windows, sliding skylight with electric wiper and sunscreen, electric windshield wash/wipe, fire extinguisher and seat belt.



Swing

Single speed, planetary swing drive with foot applied multi-disc wet brake. Spring applied, hydraulically released swing brake. Single position mechanical house lock, operated from cab. Maximum speed: 2.0 RPM.



Counterweight

9,920 lbs. (4 500 kg). Pinned to superstructure.



Hydraulic System

Two main pumps ([1] piston and [1] gear) with a combined capacity of 83.6 GPM (316.5 LPM).
Maximum operating pressure: 4,000 PSI (275.7 bar).
Three section pressure compensated valve bank. Return line type filter with full flow by-pass protection and service indicator. Replaceable cartridge with micron filtration rating of 5/12/16. 104.6 gallon (396 L) hyd. reservoir. System pressure test ports.

HOIST SPECIFICATIONS (HP15C-17G)

Main and Auxiliary Hoist

Planetary reduction with automatic spring applied multi-disc wet brake. Electronic hoist drum rotation indicators, and hoist drum cable followers.

Maximum Single Line Pull:

1st layer:	11,640 lbs. (5 280 kg)
3rd layer:	9,530 lbs. (4 323 kg)
5th layer:	8,060 lbs. (3 656 kg)

Maximum Permissible Line Pull:

11,640 lb. (5 280 kg) with 6x37 class rope
11,640 lb. (5 280 kg) with 35x7 class rope

Maximum Single Line Speed: 445 FPM (136 m/min)

Rope Construction:

6x36 EIPS IWRC, Special Flexible
35x7 Flex-X, Rotation Resistant

Rope Diameter: 5/8 in. (16 mm)

Rope Length:

Main Hoist: 450 ft. (137.0 m)
Auxiliary Hoist: 450 ft. (137.0 m)

Maximum Rope Stowage: 596 ft. (181.0 m)

**Denotes optional equipment*

RT535E

specifications

4

Carrier

Chassis

Box section frame fabricated from high-strength, low alloy steel. Front/rear towing and tie down lugs.

Outrigger System

Four hydraulic telescoping single-stage double box beam outriggers with inverted jacks and integral holding valves. Three position setting, 0%, 50% and fully extended. All steel fabricated, quick release type outrigger floats, 14.25 in. (362 mm) square.

Maximum outrigger pad load: 58,000 lbs. (26 308 kg)

Outrigger Controls

Controls and crane level indicator located in cab.

Engine (Tier II)

Cummins QSB 5.9L diesel, six cylinders, 155 bhp (116 kW) (Gross) @ 2,500 RPM.

Maximum torque: 440 ft. lbs. (597 Nm) @ 1,500 RPM.

Fuel Tank Capacity

58 gallons (219.5 L)

Transmission

Range-shift 6 speed (3 speeds x 2 range, both forward & reverse). Front axle disconnect for 4 x 2 travel.

Electrical System

Two 12 V - maintenance free batteries. 12 V starting and lighting. Battery disconnect. CanBus Diagnostic system.

Drive

4 x 4

Steering

Fully independent power steering:

Front: Full hydraulic steering wheel controlled.

Rear: Full hydraulic switch controlled.

Provides infinite variations 4 main steering modes: front only, rear only, crab and coordinated. Rear steer indicator.

Turning radius: 19 ft. (5.8 m)

Axles

Front: Drive/steer with differential and planetary reduction hubs rigid mounted to frame.

Rear: Drive/steer with differential and planetary reduction hubs pivot mounted to frame.

Oscillation Lockouts

Automatic full hydraulic lockouts on rear axle permits 10 in. (25.4 cm) oscillation only with boom centered over the front.

Brakes

Full hydraulic split circuit operating on all wheels. Spring-applied, hydraulically released parking brake mounted on front axle.

Tires

Std. 20.5 x 25 - 24 bias ply, General

Lights

Full lighting including turn indicators, head, tail, brake and hazard warning lights.

Maximum Speed

25 MPH (40 kph) @ 2500 r.p.m.

Gradeability (Theoretical)

119% (at engine stall)

Based on 61,640 lb. [27 960 kg] GVW 20.5 x 25 tires, 102 ft. (31.0 m) main boom, plus 45 ft. (13.7 m) telescopic swingaway, 9,920 lb. (4 500 kg) counterweight, 35T hookblock and 7.5T headache ball.

Miscellaneous Standard Equipment

Full width steel fenders, full length steel decking with anti-skid, dual rear view mirrors, hook-block tie down, electronic back-up alarm, light package, front stowage well, tachometer/hourmeter, rear wheel position indicator, 36,000 BTU hot water cab heater, hoist mirrors, engine distress A/V warning system, front/rear tie down and tow lugs, coolant sight lever indicator.

*Optional Equipment

* AUXILIARY HOIST PACKAGE (includes Model HP15C-17G auxiliary hoist with electronic hoist drum rotation indicator, hoist drum cable follower, 450 ft. (137.0 m) of 5/8 in. (16 mm) 35 x 7 class wire rope and auxiliary single sheave boom nose.

*AUXILIARY LIGHTING PACKAGE (includes cab mounted amber flashing light, hoist mounted work light, and dual base boom mounted floodlights).

*LMI light bar (in cab)

*Air conditioning (28,500 BTU)

*360° NYC style mechanical swing lock

*Rear pintle hook

*Cab controlled cross axle differential locks (front and rear)

*PAT data logger down-load kit

*Rubber mat for stowage trough

**Denotes optional equipment*

RT535E

GROVE.

dimensions

5

	TIRE SIZE	A	B	C	D	E	F	G	H	J	K	L	M
2 WHEEL STEER	20.5 X 25	13328	10899	10236	10007	8138	7021	2055	25.0°	22.5°	17.3°	2606	
4 WHEEL STEER	20.5 X 25	13328	10899	10185	9981	8138	7021	2093	26.0°	23.5°	18.3°	2538	
2 WHEEL STEER	16.0 X 25	9490	6732	6061	5832	4000	3498	2055	25.0°	22.5°	17.3°	2606	
4 WHEEL STEER	16.0 X 25	9490	6732	6010	5806	4000	3498	2093	26.0°	23.5°	18.3°	2635	

- NOTES:
 1. ALL DIMENSIONS ARE FOR REFERENCE ONLY.
 2. BOOM ELEVATION IS -3° TO +76°.
 3. DIMS SHOWN BASED ON 20.5 X 25 TIRES
 ADD 34.5 FOR 16.0 X 25 TIRES.

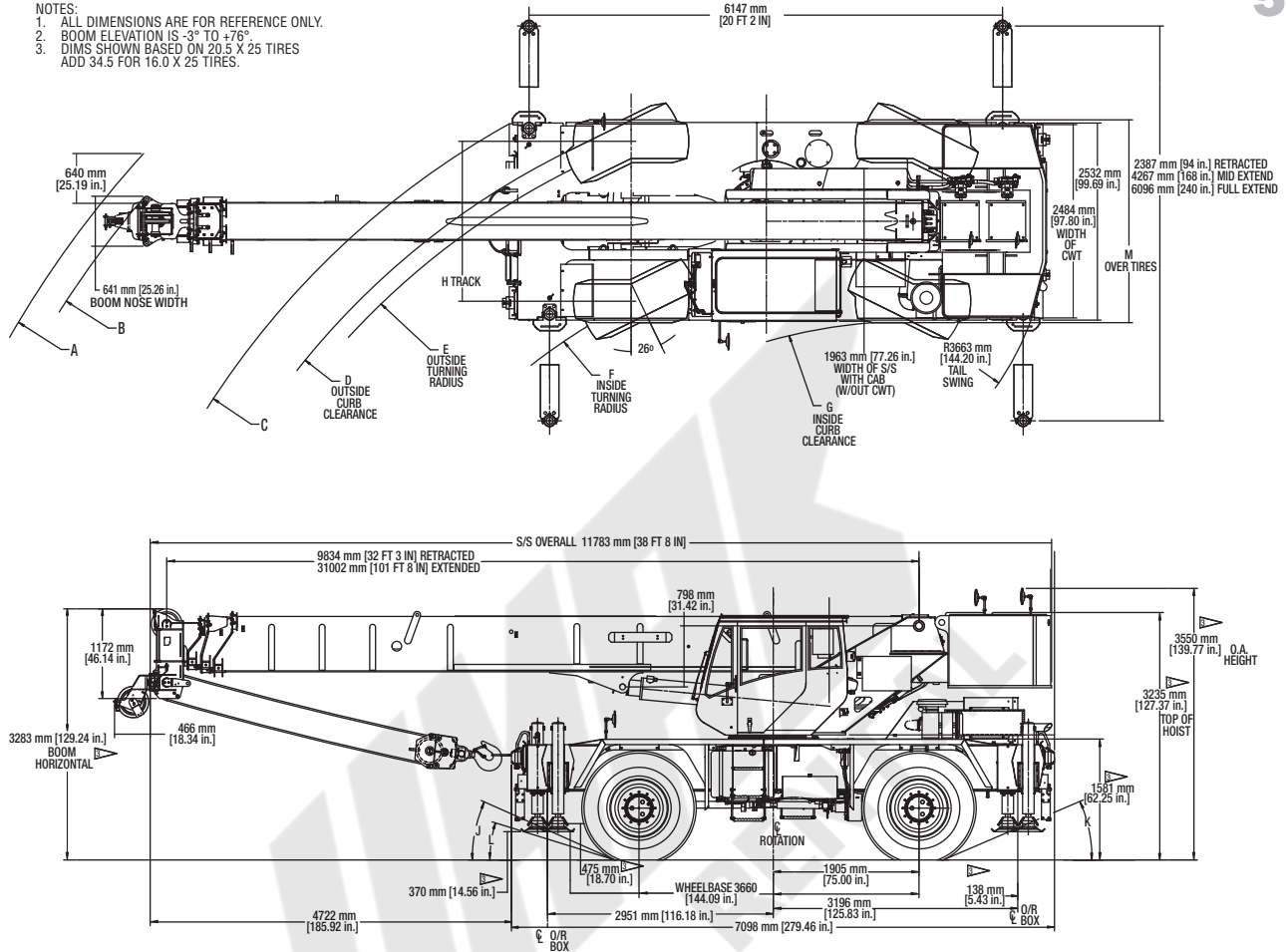

Weights

	Gross (lbs. / kg.)	Front (lbs. / kg.)	Rear (lbs. / kg.)
Basic Machine including 102 ft. (31.0m) main boom, main hoist with 450 ft. (137.0m) of rope, full counterweight + IPO, 7.5 T (6.8mt) headache ball, and 35T (35mt) hookblock:	59,135 (26 823 kg)	27,717 (12 572 kg)	31,418 (14 251 kg)
Add: Auxiliary Hoist + 450 ft. (137.0m) of 35 x 7 hoist cable and auxiliary boom nose ILO IPO C/W	59,634 (27 050 kg)	27,886 (12 649 kg)	31,748 (14 400 kg)
ADD: Fixed 26 ft. (7.9m) offsttable boom extension + extension hangers OR	61,170 (27 746 kg)	30,655 (13 905 kg)	30,515 (13 842 kg)
ADD: 26 ft. - 45 ft. (7.9 - 13.7m) telescopic boom extension + extension hangers	61,640 (27 960 kg)	31,459 (14 269 kg)	30,181 (13 690 kg)

RT535E

working range

Working range – 102 ft. Main Boom + 26-45 ft. extension

6

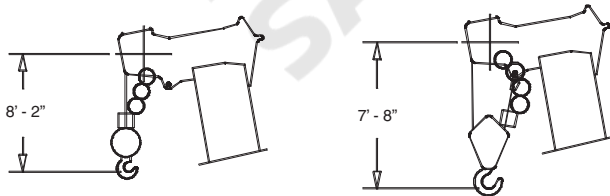
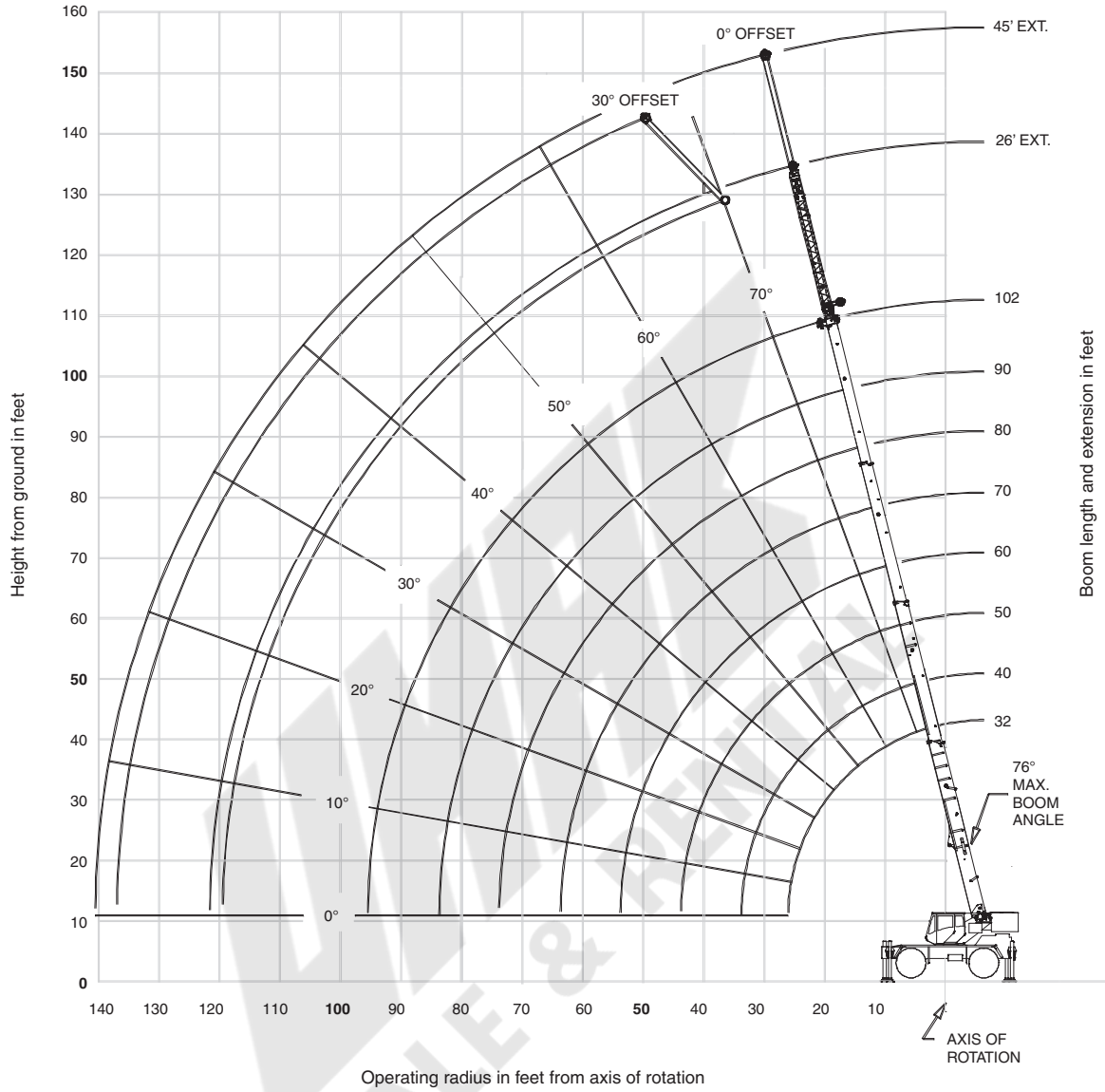

Dimensions are for largest Grove furnished hook block and headache ball, with anti-two block activated.

RT535E

THIS CHART IS ONLY A GUIDE AND SHOULD NOT BE USED TO OPERATE THE CRANE. The individual crane's load chart, operating instructions and other instructional plates must be read and understood prior to operating the crane.

GROVE.

RT535E load chart



Feet	Pounds							
	32	40	50	60	70	80	90	102
10	70,000 (65)	50,100 (70.5)	*47,000 (76)					
12	56,500 (60.5)	50,100 (67)	47,000 (72)	*46,000 (76)				
15	46,500 (54)	47,350 (62)	46,000 (68.5)	43,000 (72.5)	*38,000 (76)			
20	33,800 (41)	34,000 (53.5)	34,000 (62)	34,000 (67.5)	30,000 (71)	28,000 (74)	*22,000 (76)	
25	25,000 (20)	26,000 (43)	26,300 (55)	26,000 (62)	25,000 (66.5)	23,500 (70)	21,000 (73)	*18,000 (76)
30		20,000 (29.5)	20,500 (47.5)	20,500 (56)	21,000 (62)	20,000 (66)	18,000 (69.5)	16,300 (72)
35			16,000 (38.5)	16,500 (50)	17,500 (57)	17,000 (62)	15,500 (66)	14,400 (69)
40			13,000 (26.5)	13,500 (43)	13,500 (52)	14,000 (58)	13,100 (62)	12,600 (66)
45				11,200 (35)	10,750 (46)	11,500 (53.5)	11,250 (58.5)	11,000 (63)
50				9,000 (24)	9,000 (40)	9,500 (48.5)	9,000 (54.5)	9,300 (59.5)
55					7,300 (32.5)	8,000 (43.5)	7,500 (50.5)	7,800 (56.5)
60					6,200 (22.5)	6,600 (37.5)	6,300 (46)	6,450 (52.5)
65						5,500 (30.5)	5,300 (41)	5,300 (49)
70						4,500 (21)	4,500 (35.5)	4,400 (45)
75							3,800 (29)	3,800 (40.5)
80							3,200 (20)	3,200 (35.5)
85								2,600 (29.5)
90								2,200 (22.5)
95								1,600 (9)
								0
								102

Minimum boom angle (°) for indicated length (no load)

Maximum boom length (ft) at 0° boom angle (no load)

NOTE: () Boom angles are in degrees.

#LMI operating code. Refer to LMI manual for operating instructions.

*This capacity is based on maximum boom angle.

Lifting Capacities at Zero Degree Boom Angle								
Boom Angle	Main Boom Length in Feet							
	32	40	50	60	70	80	90	102
0°	24,000 (26)	17,000 (33.8)	11,000 (43.8)	8,000 (53.8)	5,000 (63.8)	3,500 (73.8)	2,300 (83.8)	1,250 (95.5)

NOTE: () Reference radii in feet.

A6-829-104120

RT535E

THIS CHART IS ONLY A GUIDE AND SHOULD NOT BE USED TO OPERATE THE CRANE. The individual crane's load chart, operating instructions and other instructional plates must be read and understood prior to operating the crane.

GROVE

RT535E load chart



8

Feet	Pounds			
	**26 ft. LENGTH		45 ft. LENGTH	
	#0021 0° OFFSET	#0023 30° OFFSET	#0041 0° OFFSET	#0043 30° OFFSET
35	8,200 (75)			
40	8,200 (72.5)		*5,250 (76)	
45	8,200 (70.5)	*5,780 (76)	5,250 (74)	
50	8,150 (68)	5,780 (72.5)	5,050 (72)	
55	7,500 (65)	5,450 (70)	4,650 (70)	
60	6,440 (62.5)	4,910 (67)	4,290 (67.5)	*2,730 (76)
65	5,460 (60)	4,450 (64.5)	4,000 (65.5)	2,730 (72.5)
70	4,620 (57)	4,050 (61.5)	3,800 (63)	2,730 (70.5)
75	3,900 (54.5)	3,670 (58.5)	3,650 (61)	2,600 (68)
80	3,260 (51.5)	3,350 (55.5)	3,520 (58.5)	2,520 (65.5)
85	2,710 (48)	3,100 (52)	3,360 (56)	2,470 (63)
90	2,210 (45)	2,580 (48.5)	2,980 (53.5)	2,420 (60)
95	1,770 (41)	2,080 (45)	2,530 (51)	2,390 (57.5)
100	1,380 (37.5)	1,620 (40.5)	2,130 (48)	2,380 (54.5)
105	1,020 (33)	1,200 (36)	1,770 (45)	2,310 (51.5)
110			1,450 (42)	1,910 (48)
115			1,130 (38.5)	1,530 (44.5)
120				1,180 (40)
Min. boom angle for indicated length (no load)	32°	35°	37°	39°
Max. boom length at 0° boom angle (no load)	80 ft.		80 ft.	

NOTE: () Boom angles are in degrees.
 #LMI operating code. Refer to LMI manual for instructions.
 *This capacity based on maximum boom angle.
 **26 ft. capacities are also applicable to fixed offsettable ext. However, the LMI codes will change to #0051 and #0053 for 0° and 30° offset, respectively.

A6-829-104123

BOOM EXTENSION CAPACITY NOTES:

- All capacities above the bold line are based on structural strength of boom extension.
- 26 ft. and 45 ft. boom extension lengths may be used for single line lifting service.
- Radii listed are for a fully extended boom with the boom extension erected. For main boom lengths less than fully extended, the rated loads are determined by boom angle. Use only the column which corresponds to the boom extension length and offset for which the machine is configured. For boom angles not shown, use the rating of the next lower boom angle.
WARNING: Operation of this machine with heavier loads than the capacities listed is strictly prohibited. Machine tipping with boom extension occurs rapidly and without advance warning.
- Boom angle is the angle above or below horizontal of the longitudinal axis of the boom base section after lifting rated load.
- Capacities listed are with outriggers fully extended and vertical jacks set only.
- When lifting over the main boom nose with 26 ft. or 45 ft. extension erected, the outriggers must be fully extended or 50% extended (14' spread).

RT535E

THIS CHART IS ONLY A GUIDE AND SHOULD NOT BE USED TO OPERATE THE CRANE. The individual crane's load chart, operating instructions and other instructional plates must be read and understood prior to operating the crane.

GROVE

RT535E load charts

32 - 102 ft.
 9,920 lbs
 50%
14' spread
 360°

Feet	30	40	50	60	70	80	90	102
10	68,700 (65)	50,100 (70.5)	*47,000 (76)					
12	56,500 (60.5)	50,100 (67)	47,000 (72)	*46,000 (76)				
15	46,100 (54)	44,200 (62)	41,750 (68.5)	39,500 (72.5)	*37,550 (76)			
20	26,850 (41)	27,550 (53.5)	27,050 (62)	25,950 (67.5)	24,950 (71)	24,000 (74)	*22,000 (76)	
25	17,450 (20)	18,050 (43)	18,650 (55)	18,600 (62)	18,050 (66.5)	17,450 (70)	16,950 (73)	*16,300 (76)
30		12,700 (29.5)	13,200 (47.5)	13,500 (56)	13,550 (62)	13,250 (66)	12,900 (69.5)	12,500 (72)
35			9,700 (38.5)	10,050 (50)	10,200 (57)	10,250 (62)	10,100 (66)	9,810 (69)
40			7,260 (26.5)	7,570 (43)	7,770 (52)	7,910 (58)	7,940 (62)	7,810 (66)
45				5,750 (35)	5,940 (46)	6,110 (53.5)	6,180 (58.5)	6,200 (63)
50				4,350 (24)	4,540 (40)	4,700 (48.5)	4,790 (54.5)	4,860 (59.5)
55					3,430 (32.5)	3,590 (43.5)	3,690 (50.5)	3,780 (56.5)
60					2,530 (22.5)	2,680 (37.5)	2,790 (46)	2,890 (52.5)
65						1,940 (30.5)	2,040 (41)	2,150 (49)
70						1,310 (21)	1,420 (35.5)	1,530 (45)
						0	20	36
							80	

Minimum boom angle (°) for indicated length (no load)
 Maximum boom length (ft.) at 0° boom angle (no load)

NOTE: () Boom angles are in degrees.
 #LMI operating code. Refer to LMI manual for operating instructions.
 *This capacity is based on maximum boom angle.

Boom Angle	Lifting Capacities at Zero Degree Boom Angle				
	Main Boom Length in Feet				
	32	40	50	60	70
0°	16,100 (26)	9,970 (33.8)	5,850 (43.8)	3,490 (53.8)	1,950 (63.8)

NOTE: () Reference radii in feet.

A6-829-104121

9

SALE & RENTAL

RT535E

THIS CHART IS ONLY A GUIDE AND SHOULD NOT BE USED TO OPERATE THE CRANE. The individual crane's load chart, operating instructions and other instructional plates must be read and understood prior to operating the crane.

GROVE

load charts

10



Feet	**26 ft. LENGTH		45 ft. LENGTH	
	#4021	#4023	#4041	#4043
	0° OFFSET	30° OFFSET	0° OFFSET	30° OFFSET
35	8,200 (75)			
40	7,090 (72.5)		*5,250 (76)	
45	5,640 (70.5)	*5,780 (76)	5,250 (74)	
50	4,470 (68)	5,620 (72.5)	5,050 (72)	
55	3,510 (65)	4,520 (70)	4,210 (70)	
60	2,720 (62.5)	3,600 (67)	3,430 (67.5)	*2,730 (76)
65	2,020 (60)	2,780 (64.5)	2,770 (65.5)	2,730 (72.5)
70	1,420 (57)	2,090 (61.5)	2,170 (63)	2,730 (70.5)
75		1,490 (58.5)	1,650 (61)	2,600 (68)
80			1,200 (58.5)	2,150 (65.5)
85				1,660 (63)
90				1,230 (60)
Min. boom angle for indicated length (no load)	56°	57°	57°	59°
Max. boom length at 0° boom angle (no load)		60 ft.	60 ft.	

NOTE: () Boom angles are in degrees.
 #LMI operating code. Refer to LMI manual for instructions.
 *This capacity based on maximum boom angle.
 **26 ft. capacities are also applicable to fixed offsettable ext. However, the LMI codes will change to #4051 and #4053 for 0° and 30° offset, respectively.

A6-829-104124

BOOM EXTENSION CAPACITY NOTES:

- All capacities above the bold line are based on structural strength of boom extension.
 - 26 ft. and 45 ft. boom extension lengths may be used for single line lifting service.
 - Radii listed are for a fully extended boom with the boom extension erected. For main boom lengths less than fully extended, the rated loads are determined by boom angle. Use only the column which corresponds to the boom extension length and offset for which the machine is configured. For boom angles not shown, use the rating of the next lower boom angle.
- WARNING:** Operation of this machine with heavier loads than the capacities listed is strictly prohibited. Machine tipping with boom extension occurs rapidly and without advance warning.
- Boom angle is the angle above or below horizontal of the longitudinal axis of the boom base section after lifting rated load.
 - Capacities listed are with outriggers properly extended and vertical jacks set only.
 - When lifting over the main boom nose with 26 ft. or 45 ft. extension erected, the outriggers must be fully extended or 50% extended (14' spread).

RT535E

THIS CHART IS ONLY A GUIDE AND SHOULD NOT BE USED TO OPERATE THE CRANE. The individual crane's load chart, operating instructions and other instructional plates must be read and understood prior to operating the crane.

GROVE.

load charts

11

32 - 60 ft. 9,920 lbs Stationary 360°

Pounds				
#9005				
Feet	Main Boom Length in Feet			
	32	40	50	60
10	22,950 (65)	22,950 (70.5)	*23,000 (76)	
12	21,150 (60.5)	21,850 (67)	21,600 (72)	
15	14,300 (54)	15,300 (62)	15,950 (68.5)	13,850 (72.5)
20	8,330 (40.5)	9,180 (53.5)	9,710 (62)	9,940 (67.5)
25	5,100 (20)	5,880 (43)	6,260 (55)	6,530 (62)
30		3,810 (29.5)	4,100 (47)	4,360 (56)
35			2,630 (38)	2,870 (50)
40			1,550 (26)	1,800 (43)
Minimum boom angle (°) for indicated length (no load)			25	42
Maximum boom length (ft.) at 0° boom angle (no load)			40	

NOTE: () Boom angles are in degrees.
#LMI operating code. Refer to LMI manual for operating instructions.
*This capacity is based on maximum boom angle.

Lifting Capacities at 0° Boom Angle

Boom Angle	Main Boom Length in Feet	
	32	40
0°	4,600 (26)	2,700 (33.8)

NOTE: () Reference radii in feet.

A6-829-104125

32 - 60 ft. 9,920 lbs Pick & Carry (Max. 2.5 MPH) 20.5 x 25 OR 16 x 25 tires Boom Centered Over Front

Pounds				
#9006				
Feet	Main Boom Length in Feet			
	32	40	50	60
10	26,850 (64.5)	27,250 (70)		
12	23,150 (60.5)	23,500 (67)		
15	18,800 (53.5)	19,200 (62)	19,450 (68)	
20	13,600 (40.5)	14,150 (53)	14,500 (61.5)	14,550 (67)
25	10,050 (19.5)	10,600 (42.5)	11,100 (54.5)	11,200 (61.5)
30		8,040 (29)	8,570 (47)	8,740 (56)
35			6,650 (38)	6,810 (49.5)
40			5,130 (26)	5,300 (42.5)
45				4,090 (34.5)
50				3,090 (23.5)
Minimum boom angle (°) for indicated length (no load)			0	
Maximum boom length (ft.) at 0° boom angle (no load)			60	

NOTE: () Boom angles are in degrees.
#LMI operating code. Refer to LMI manual for operating instructions.

Lifting Capacities at 0° Boom Angle

Boom Angle	Main Boom Length in Feet			
	32	40	50	60
0°	9,480 (26)	6,530 (33.8)	4,190 (43.8)	2,440 (53.8)

NOTE: () Reference radii in feet.

A6-829-104126

BOOM EXTENSION CAPACITY NOTES:

- Capacities are in pounds and do not exceed 75% of tipping loads as determined by test in accordance with SAE J765.
- Capacities are applicable to machines equipped with 20.5x25 (24 ply) tires at 75 psi cold inflation pressure, and 16.00x25 (28 ply) tires at 100 psi cold inflation pressure.
- Capacities appearing above the bold line are based on structural strength and tipping should not be relied upon as a capacity limitation.
- Capacities are applicable only with machine on firm level surface.
- On rubber lifting with boom extensions not permitted.
- For pick and carry operation, boom must be centered over front of machine, mechanical swing lock engaged and load restrained from swinging. When handling loads in the structural range with capacities close to maximum ratings, travel should be reduced to creep speeds.
- Axle lockouts must be functioning when lifting on rubber.
- All lifting depends on proper tire inflation, capacity and condition. Capacities must be reduced for lower tire inflation pressures. See lifting capacity chart for tire used. Damaged tires are hazardous to safe operation of crane.
- Creep – not over 200 ft. of movement in any 30 minute period and not exceeding 1 mph.

THIS CHART IS ONLY A GUIDE AND SHOULD NOT BE USED TO OPERATE THE CRANE. The individual crane's load chart, operating instructions and other instructional plates must be read and understood prior to operating the crane.

load charts

32 - 102 ft.
 9,920 lbs
 0%
 7.8' spread
 360°

12

Feet	Pounds							
	30	40	50	60	70	80	90	102
10	37,650 (65)	35,900 (70.5)	*33,600 (76)					
12	28,900 (60.5)	28,000 (67)	26,550 (72)	*25,100 (76)				
15	20,700 (54)	20,300 (62)	19,750 (68.5)	18,800 (72.5)	*18,000 (76)			
20	12,300 (41)	12,800 (53.5)	12,850 (62)	12,550 (67.5)	12,100 (71)	11,650 (74)	*11,250 (76)	
25	7,760 (20)	8,240 (43)	8,670 (55)	8,700 (62)	8,530 (66.5)	8,290 (70)	8,030 (73)	7,710 (76)
30		5,400 (29.5)	5,810 (47.5)	6,120 (56)	6,060 (62)	5,940 (66)	5,820 (69.5)	5,590 (72)
35			3,870 (38.5)	4,170 (50)	4,290 (57)	4,220 (62)	4,160 (66)	4,050 (69)
40			2,470 (26.5)	2,760 (43)	2,940 (52)	2,930 (58)	2,900 (62)	2,820 (66)
45				1,690 (35)	1,850 (46)	1,910 (53.5)	1,910 (58.5)	1,860 (63)
50					1,000 (40)	1,100 (48.5)	1,110 (54.5)	1,080 (59.5)
Minimum boom angle (°) for indicated length (no load)				0	33	44	51	57
Maximum boom length (ft.) at 0° boom angle (no load)						60		

NOTE: () Boom angles are in degrees.
 #LMI operating code. Refer to LMI manual for operating instructions.
 *This capacity is based on maximum boom angle.

Lifting Capacities at Zero Degree Boom Angle

Boom Angle	Main Boom Length in Feet		
	32	40	50
0°	7,060 (26)	3,870 (33.8)	1,640 (43.8)

NOTE: () Reference radii in feet.

A6-829-104122

RT535E

THIS CHART IS ONLY A GUIDE AND SHOULD NOT BE USED TO OPERATE THE CRANE. The individual crane's load chart, operating instructions and other instructional plates must be read and understood prior to operating the crane.

GROVE.

load handling

13

Weight Reductions for Load Handling Devices

26 ft. Offsettable Boom Extension	Pounds
*Erected -	2,750

26 ft.-45 ft. Tele. Boom Extension	Pounds
*Erected (Retracted) -	3,850
*Erected (Extended) -	5,130

*Reduction of main boom capacities

Auxiliary Boom Nose	Pounds
	105

Hookblocks and Headache Balls	Pounds
35 Ton, 3 Sheave	623 +
35 Ton, 4 Sheave (CE)	774 +
7.5 Ton Overhaul Ball	369 +

+Refer to rating plate for actual weight.

When lifting over swingaway and/or jib combinations, deduct total weight of all load handling devices reeved over main boom nose directly from swingaway or jib capacity.

NOTE: All load handling devices and boom attachments are considered part of the load and suitable allowances MUST BE MADE for their combined weights. Weights are for Grove furnished equipment.

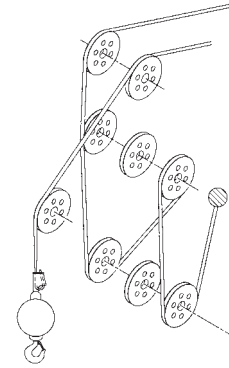

Line Pulls and Reeving Information

Hoists	Cable Specs	Permissible Line Pulls	Nominal Cable Length
Main & Aux.	5/8" (16 mm) Flex-X35 (35x7)	11,640 lb.	450 ft.
	Rotation Resistant (non-rotating)		
Main	5/8" (16 mm) 6x37 Class	11,640 lb.	450 ft.
	EIPS, IWRC Special Flexible		
	Min. Breaking Str. 61,200 lb.		
	Min. Breaking Str. 41,200 lb.		

Hoist Performance

Wire Rope Layer	Hoist Line Pulls Available lb.*	Drum Rope Capacity (ft.)	
		Layer	Total
1	11,640	77	77
2	10,480	85	162
3	9,530	94	256
4	8,730	102	358
5	8,060	111	469
6	7,490	119	588

*Max. lifting capacity: 6x37 class = 11,640 lb.
35x7 class = 11,640 lb.

Working Area Diagram

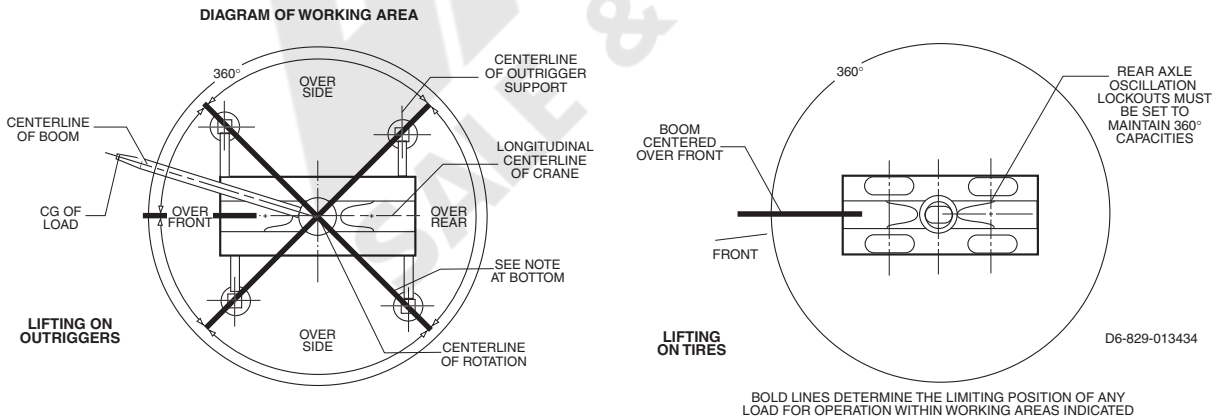

Bold lines determine the limiting position of any load for operation within working areas indicated.

THIS CHART IS ONLY A GUIDE AND SHOULD NOT BE USED TO OPERATE THE CRANE. The individual crane's load chart, operating instructions and other instructional plates must be read and understood prior to operating the crane.



RT535E

GROVE.

UMAR
SALE & RENTAL

RT535E



Manitowoc Crane Group - Americas

Manitowoc, Wisconsin Facility
Tel: [Int + 001] 920 684 6621
Fax: [Int + 001] 920 683 6277
Shady Grove, Pennsylvania Facility
Tel: [Int + 001] 717 597 8121
Fax: [Int + 001] 717 597 4062

Manitowoc Crane Group - EMEA

Europe Middle East & Africa
Tel: [Int + 33] (0) 191 565 6281
Fax: [Int + 33] (0) 4 72 18 20 20

Manitowoc Crane Group - UK

Europe Middle East & Africa
Tel: [Int + 44] (0) 191 565 6281
Fax: [Int + 44] (0) 191 564 0442

Manitowoc Crane Group - Germany

(Sales, Parts & Service)
Tel: [Int + 49](0) 2173 8909 0
Fax: [Int + 49] (0) 2173 8909-30

Manitowoc Crane Group - France

France & Africa (Sales, Parts & Service)
Tel: [Int + 33] (0) 1 303 13150
Fax: [Int + 33] (0) 1 303 86085

Manitowoc Crane Group - Netherlands

(Sales, Parts & Service)
Tel: [Int + 31] (0) 76 578 39 99
Fax: [Int + 31] (0) 76 578 39 78

Manitowoc Crane Group - Italy

Italy & Southern Europe (Sales, Parts & Service)
Tel: [Int + 39] (0) 331 49 33 11
Fax: [Int + 39] (0) 331 49 33 30

Manitowoc Crane Group - Portugal

Portugal & Spain (Sales, Parts & Service)
Tel: [Int + 351] (0) 22 968 08 89
Fax: [Int + 351] (0) 22 968 08 97

Manitowoc Crane Group - Singapore

Asia/Pacific excl China (Sales, Parts & Service)
Tel: [Int + 65] 6861 1733
Fax: [Int + 65] 6862 4040 / 4142

Manitowoc Crane Group - Shanghai

China (Sales, Parts & Service)
Tel: [Int + 86] (0) 21 64955555
Fax: [Int + 86] (0) 2164852038

Manitowoc Crane Group - Beijing

China (Sales, Parts & Service)
Tel: [Int + 86] (0) 10 646 71690
Fax: [Int + 86] (0) 10 646 71691

Manitowoc Crane Group - Middle East

(Sales)
Tel: [Int + 971] (0) 4 348 4478
Fax: [Int + 971] (0) 4 348 4478
(Parts & Service)
Tel: [Int + 973] (0) 9 660 899
Fax: [Int + 973] (0) 2 707 740

Distributed By:

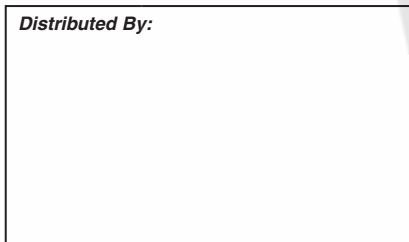

www.manitowoccrane.com



Constant improvement and engineering progress make it necessary that we reserve the right to make specification, equipment, and price changes without notice. Illustrations shown may include optional equipment and accessories, and may not include all standard equipment.