

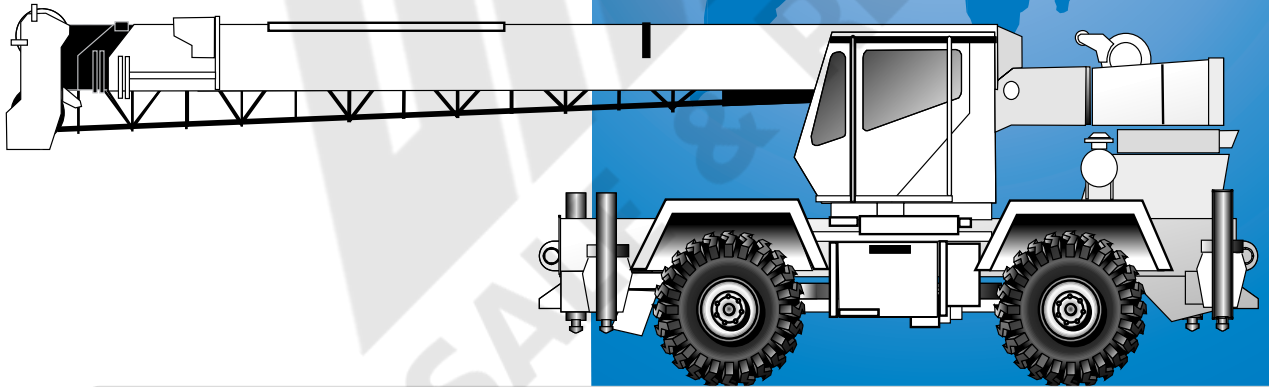

# RT500C



**Rough Terrain Hydraulic Crane**

# Dimensions

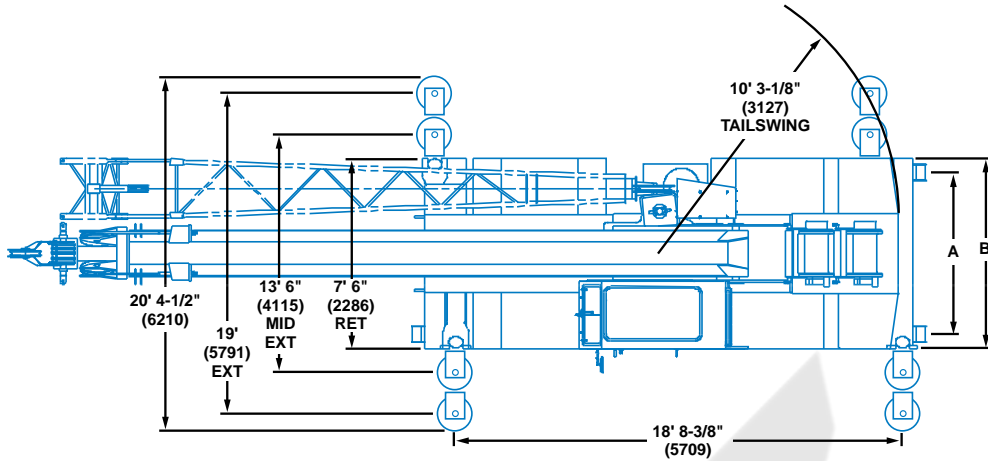

TIRE SIZE	16.00 x 25	20.5 x 25
A (TRACK)	6' 5-1/2" (1969)	6' 9-1/8" (2061)
B (OAW)	8' (2438)	8' 9" (2667)
GROUND CLEARANCE	1' 7-1/8" (486)	

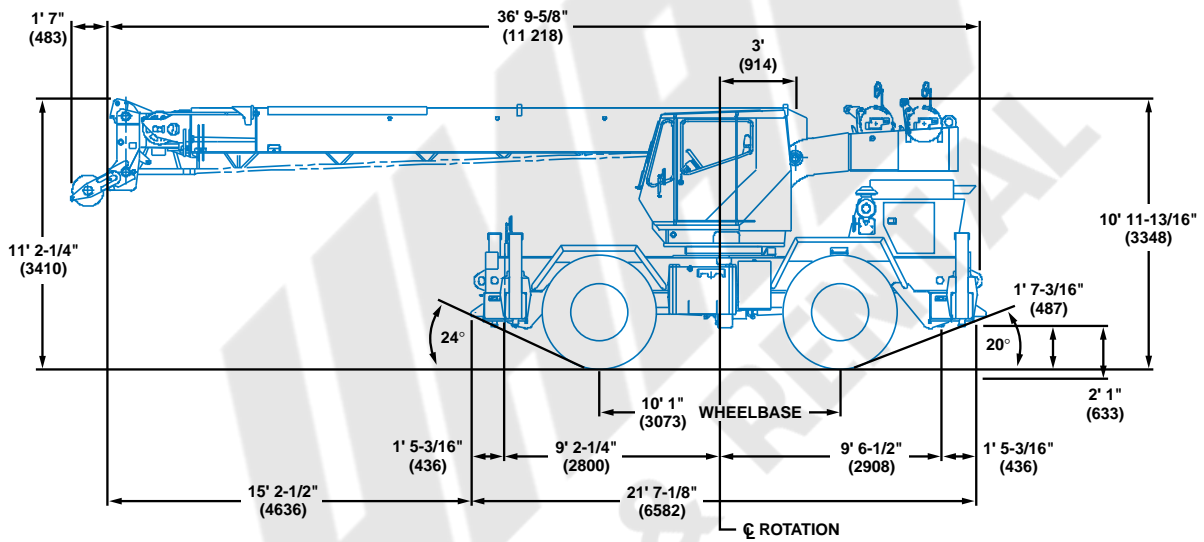

Note: ( ) Reference dimensions in mm

- Turning Radius . . . . . 17' 0" (5182 mm)
- Front Axle Load . . . . . 23,959 lbs. (10 868 kg)
- Rear Axle Load . . . . . 29,094 lbs. (13 197 kg)
- Gross Vehicle Weight . . . . . 53,053 lbs. (24 065 kg)

# Working range



28 - 70 ft.  
(8.5 - 21.3 m)

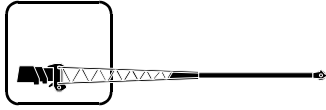

25 - 43 ft.  
(7.6 - 13.1 m)

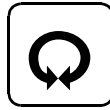
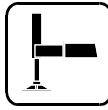

360°

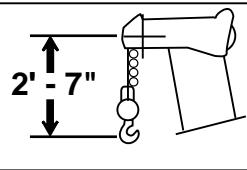
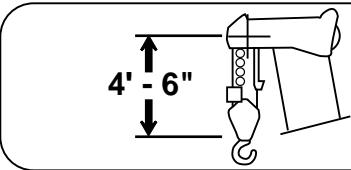
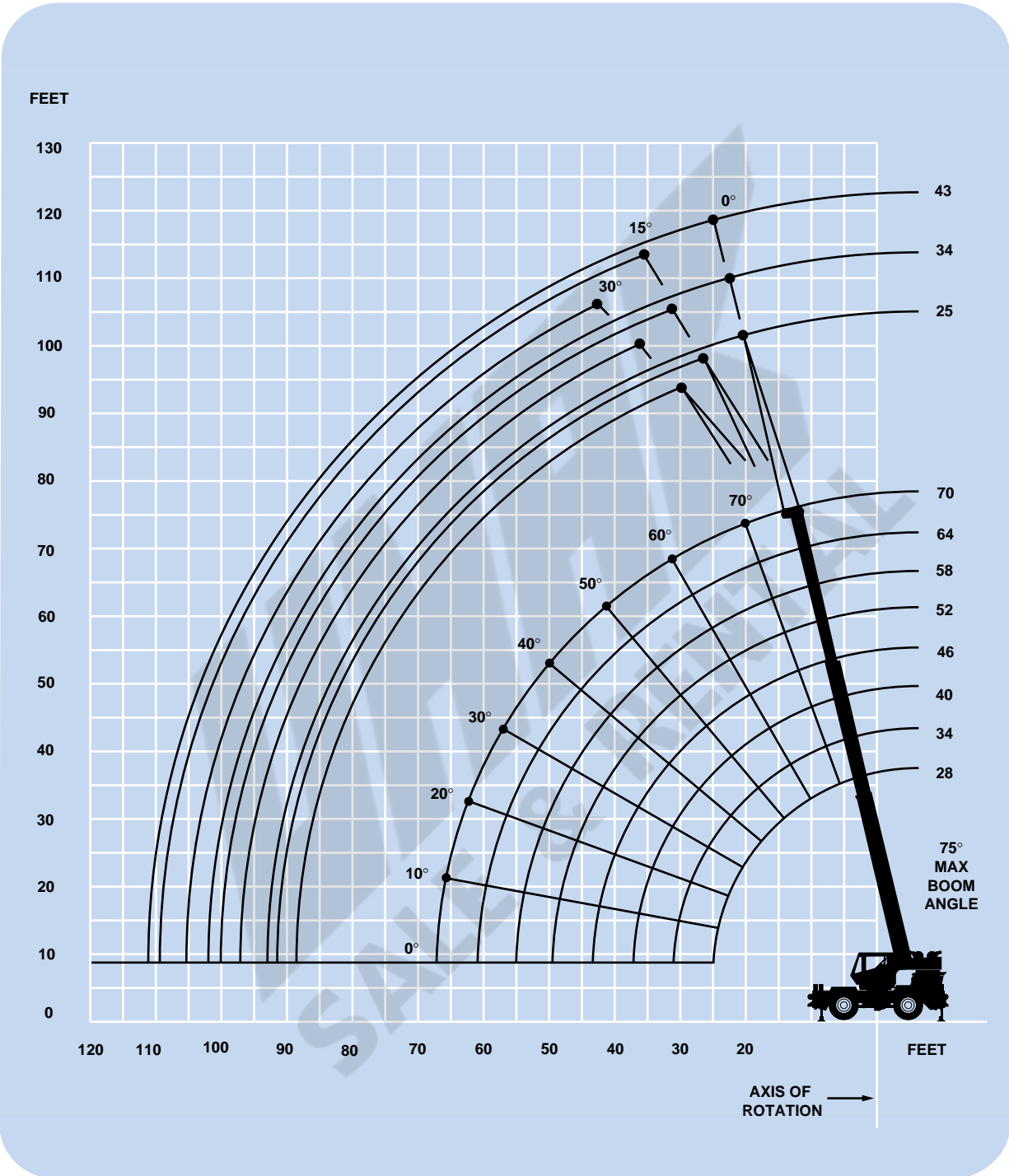

DIMENSIONS ARE FOR LARGEST GROVE FURNISHED HOOK BLOCK AND HEADACHE BALL, WITH ANTI-TWO BLOCK ACTIVATED.

# Superstructure specifications

## Boom

28 ft. - 70 ft. (8.5 m - 21.3 m) three-section, full power boom. Maximum tip height: 76 ft. (23.1 m).

### \*Optional Jib

23 ft. (7.1 m) "A" frame jib offsettable at 0°, 15° or 30°. Stows beneath base boom section. Maximum tip height: 98 ft. (29.9 m).

### \*Optional Swingaway Extension

25 ft. (7.6 m) lattice swingaway boom extension. Stows alongside base boom section. Maximum tip height: 102 ft. (31.0 m).

### \*Optional Telescopic Swingaway Extension

25 ft. to 34 ft. or 43 ft. (7.6 m to 10.4 m or 13.1 m) telescoping lattice swingaway extension with integral offset mechanism, offsettable at 0°, 15° or 30°. Stows alongside base boom section. Maximum tip height: 120 ft. (36.6 m).

## Boom Nose

Four steel sheaves mounted on heavy duty tapered roller bearings with removable pin-type rope guards. \*Optional removable auxiliary boom nose with removable pin type rope guard.

## Boom Elevation

Two double acting hydraulic cylinders with integral holding valves provide elevation from 0° to 75°.

## Load Moment & Anti-Two Block System

Standard load moment and anti-two block system with audio-visual warning and control lever lockout. These systems provide electronic display of boom angle, length, radius, tip height, relative load moment, maximum permissible load, load indication and warning of impending two-block condition.

## Cab

Full vision, all steel fabricated with acoustical lining and tinted safety glass throughout. Deluxe seat incorporates armrest mounted hydraulic single-axis controllers. Dash panel incorporates gauges for all engine functions. Other standard features include: telescoping tilt steering wheel, sliding side and rear windows, electric windshield wash/wipe, circulating air fan, manual skylight wiper, fire extinguisher, seat belt and ashtray.

## Swing

Ball bearing swing circle with 360° continuous rotation. Grove planetary glide-swing with multi-disc wet brake. Spring applied, hydraulically released parking brake and plunger-type, one position, mechanical house lock and 360° positive swing lock operated from cab. Maximum speed: 2.5 RPM.

## Counterweight

Removable, bolted to turntable mast. Main hoist: 10,170 lbs. (4613 kg). Main and Auxiliary hoist: 9,120 lbs. (4136 kg).

## Hydraulic System

3 main gear pumps with a combined capacity of 112.5 GPM (426 LPM) driven by carrier engine through P.T.O. \*Optional pump disconnect with engine jogging switch. Maximum operating pressure: 2500 PSI (172.4 bar).

## Hoist Specifications

### Main or \*Auxiliary Hoist

Power up and down equal speed, grooved drum, planetary reduction with automatic spring applied multi-disc brake, hoist drum rotation indicators, cable followers.

Maximum Single Line Speed:	429 FPM (131 m/min)
Maximum Single Line Pull (1st Layer):	9,640 lbs. (4372 kg)
Maximum Permissible Line Pull w/5:1 Strength Factor:	9,080 lbs. (4119 kg) 5/8 in. (16 mm) 18 x 19 class
Maximum Rope Stowage:	375 ft. (114 m) 5/8 in. (16 m)

*\*Denotes optional equipment*

# Carrier specifications

## Chassis

High strength alloy steel, all welded box section design with integral outrigger housings and front/rear lifting, towing and tie down lugs.

## Outrigger System

Four hydraulic, telescoping, single-stage, double box beam outriggers with inverted jacks and integral holding valves. Three position setting. All steel fabricated, quick release type square outrigger floats, 16.5 in. (419 mm) diameter.  
Maximum outrigger pad load: 50,254 lbs. (22 795 kg).

## Outrigger Controls

Controls and crane level indicator located in cab.

## Engine

Cummins 6BT 5.9 L, six cylinder, turbocharged, water cooled diesel. 130 bhp (97 kW) (Gross) @ 2,500 RPM. Maximum torque: 386 ft. lbs. (523 Nm) @ 1,400 RPM.

## Fuel Tank Capacity

60 gallons (227 L)

## Transmission

Remote mounted powershift with 6 forward and 6 reverse speeds. 3 in high range, 3 in low range. Rear axle disconnect for 4 x 2 travel.

## Electrical System

Two 12 V - maintenance free batteries, 625 CCA @ 0° F. 12 V starting and lighting.

## Drive

4 x 4.

## Steering

Fully independent power steering:  
Front: Full hydraulic steering wheel controlled.  
Rear: Full hydraulic hand lever controlled.  
Provides infinite variations of 4 main steering modes: front only, rear only, crab and coordinated.

## Axles

Front: Drive/steer with differential and planetary reduction hubs rigid mounted to chassis.  
Rear: Drive/steer with differential and planetary reduction hubs pivot mounted at the center of chassis providing up to 12 in. (305 mm) oscillation.

\*Optional: No spin differential on rear axle.

## Oscillation Lockouts

Automatic full hydraulic lockouts on rear axle permit oscillation only with boom centered over the front.  
\*Optional oscillation lockout override control.

## Brakes

Dual braking system, air over hydraulic operating on all wheels. Spring-applied, air released front axle mounted parking brake.

## Tires

20.5 x 25 - 24PR earthmover type, tubeless.  
\*16.00 x 25 - 28PR earthmover type, tubeless.

## Lights

Full lighting package including turn indicators, head, tail, brake and hazard warning lights.

## Maximum Speed

22.8 MPH (36.7 kph).

## Gradeability (Theoretical)

110.5% (Based on 51,610 lbs. [23 410 kg] GVW) 20.5 x 25 tires, pumps disengaged, 70 ft. (21.3 m) boom.

## Miscellaneous Standard Equipment

Full width steel fenders, dual rear view mirrors, hookblock tiedown sling, electronic back-up alarm, light package, front stowage well, control valve for auxiliary hoist, 360° positive swing lock.

## \*Optional Equipment

- \*Auxiliary hoist
- \*Boom mounted worklights
- \*360° flashing light
- \*Cab spotlight
- \*Tachometer
- \*Cold start aid (less canister)
- \*Engine block heater
- \*Electric skylight wiper, with opening skylight
- \*Hookblocks
- \*Tow winch - front mounted maximum pull: 15,000 lbs. (6804 kg); maximum speed: 75 ft./min. (23 m/min).
- \*Spare wheel assembly
- \*Tire inflation kit
- \*Tool kit
- \*Pintle hook front/rear
- \*High speed glide system
- \*Propane or diesel heater/defroster
- \*Air conditioning
- \*Dual axis joystick controllers
- \*Hydraulic oil cab heater
- \*Headache ball
- \*Emergency steer pump
- \*LMI light bar

*\*Denotes optional equipment*



28 - 70 ft.  
(8.5 - 21.3 m)



10,170 lbs.  
(4613 kg)



100%



360°



Pounds

Feet	28	34	40	46	52	58	64	70	
10	56,000 (64)	36,000 (69)	36,000 (73)						
12	40,000 (59.5)	36,000 (65.5)	36,000 (70)	35,000 (73)					
15	31,000 (51.5)	31,000 (59.5)	30,950 (65)	30,300 (69)	29,750 (72)	29,150 (74.5)			
20	23,200 (36.5)	23,200 (49)	23,200 (57)	23,200 (62)	23,000 (66)	22,600 (69.5)	22,250 (72)	20,500 (74)	
25	17,950 (6)	17,950 (36)	17,950 (47.5)	17,950 (54.5)	17,950 (60)	17,950 (64)	17,950 (67)	17,650 (69.5)	
30		15,350 (15.5)	15,350 (36.5)	15,350 (46.5)	15,350 (53)	15,150 (58)	14,950 (62)	14,750 (65)	
35			12,850 (20)	12,850 (36.5)	12,850 (45.5)	12,800 (51.5)	12,650 (56.5)	12,500 (60)	
40				10,750 (23)	10,750 (36.5)	10,750 (45)	10,750 (50.5)	10,750 (55)	
45					9,020 (25)	9,020 (37)	9,020 (44.5)	9,020 (49.5)	
50						7,420 (26.5)	7,420 (37)	7,420 (43.5)	
55						6,170 (3.5)	6,170 (28)	6,170 (37)	
60							5,170 (13)	5,170 (28.5)	
65								4,350 (15.5)	
Minimum boom angle (deg.) for indicated length (no load)									0
Maximum boom length (ft.) at 0 degree boom angle (no load)									70

NOTE: ( ) Boom angles are in degrees.

A6-829-008639 & -003716H

Boom Angle	28	34	40	46	52	58	64	70
0°	15,286 (25.1)	12,000 (31)	9,230 (37)	7,050 (43)	5,630 (49)	4,440 (55)	3,480 (61)	2,800 (66.6)

NOTE: ( ) Reference radii are in feet.

A6-829-009460



28 - 70 ft.  
(8.5 - 21.3 m)



10,170 lbs.  
(4613 kg)



50%  
13' 5" Spread



360°



Pounds

Feet	28	34	40	46	52	58	64	70
10	49,200 (64)	36,000 (69)	36,000 (73)					
12	40,000 (59.5)	36,000 (65.5)	36,000 (70)	35,000 (73)				
15	31,000 (51.5)	31,000 (59.5)	30,950 (65)	30,300 (69)	29,750 (72)	29,150 (74.5)		
20	23,200 (36.5)	23,200 (49)	23,000 (57)	22,500 (62)	22,000 (66)	21,500 (69.5)	21,050 (72)	20,500 (74)
25	15,200 (6)	15,200 (36)	15,200 (47.5)	15,200 (54.5)	15,200 (60)	15,200 (64)	15,200 (67)	15,150 (69.5)
30		11,150 (15.5)	11,150 (36.5)	11,150 (46.5)	11,150 (53)	11,150 (58)	11,150 (62)	11,150 (65)
35			8,520 (20)	8,520 (36.5)	8,520 (45.5)	8,520 (51.5)	8,520 (56.5)	8,520 (60)
40				6,680 (23)	6,680 (36.5)	6,680 (45)	6,680 (50.5)	6,680 (55)
45					5,320 (25)	5,320 (37)	5,320 (44.5)	5,320 (49.5)
50						4,270 (26.5)	4,270 (37)	4,270 (43.5)
55						3,440 (3.5)	3,440 (28)	3,440 (37)
60							2,770 (13)	2,770 (28.5)
65								2,210 (15.5)
Minimum boom angle (deg.) for indicated length (no load)								0
Maximum boom length (ft.) at 0 degree boom angle (no load)								70

NOTE: ( ) Boom angles are in degrees.

Boom Angle	28	34	40	46	52	58	64	70
0°	15,150 (25.1)	10,500 (31)	7,720 (37)	5,810 (43)	4,460 (49)	3,440 (55)	2,650 (61)	2,050 (66.6)

NOTE: ( ) Reference radii in feet.

A6-829-012237



28 - 70 ft.  
(8.5 - 21.3 m)



10,170 lbs.  
(4613 kg)



0%  
7' 5" Spread



360°



Pounds

Feet	28	34	40	46	52	58	64	70
10	28,700 (64)	28,700 (69)	28,050 (73)					
12	20,950 (59.5)	20,950 (65.5)	20,950 (70)	20,950 (73)				
15	14,450 (51.5)	14,450 (59.5)	14,450 (65)	14,450 (69)	14,450 (72)	14,450 (74.5)		
20	9,020 (36.5)	9,020 (49)	9,020 (57)	9,020 (62)	9,020 (66)	9,020 (69.5)	9,020 (72)	9,020 (74)
25	6,120 (6)	6,120 (36)	6,120 (47.5)	6,120 (54.5)	6,120 (60)	6,120 (64)	6,120 (67)	6,120 (69.5)
30		4,330 (15.5)	4,330 (36.5)	4,330 (46.5)	4,330 (53)	4,330 (58)	4,330 (62)	4,330 (65)
35			3,110 (20)	3,110 (36.5)	3,110 (45.5)	3,110 (51.5)	3,110 (56.5)	3,110 (60)
40				2,230 (23)	2,230 (36.5)	2,230 (45)	2,230 (50.5)	2,230 (55)
45					1,560 (25)	1,560 (37)	1,560 (44.5)	1,560 (49.5)
50						1,030 (26.5)	1,030 (37)	1,030 (43.5)
Minimum boom angle (deg.) for indicated length (no load)								40.5
Maximum boom length (ft.) at 0 degree boom angle (no load)								52

NOTE: ( ) Boom angles are in degrees.

Boom Angle	28	34	40	46	52
0°	6,090 (25.1)	4,050 (31)	2,720 (37)	1,800 (43)	1,130 (49)

NOTE: ( ) Reference radii in feet.

A6-829-012238





25 - 43 ft.  
(7.6 - 13.1 m)



10,170 lbs.  
(4613 kg)



100%



360°



Pounds

Feet	25 ft. LENGTH			34 ft. LENGTH			43 ft. LENGTH		
	0° OFFSET	15° OFFSET	30° OFFSET	0° OFFSET	15° OFFSET	30° OFFSET	0° OFFSET	15° OFFSET	30° OFFSET
25	*12,500 (75)	*7,300 (75)		*7,700 (75)			*4,500 (75)		
30	10,700 (71.5)	7,170 (74)	*5,250 (75)	7,180 (73)	*4,900 (75)		4,430 (74)		
35	9,230 (68)	6,490 (70.5)	5,080 (73)	6,110 (70)	4,790 (73.5)		3,960 (71.5)	*2,800 (75)	
40	8,280 (65)	5,900 (67.5)	4,730 (69.5)	5,370 (67)	4,360 (70.5)	*3,200 (75)	3,610 (68.5)	2,770 (74)	
45	7,340 (61.5)	5,460 (64)	4,440 (66)	4,870 (63.5)	4,020 (67.5)	2,900 (71.5)	3,360 (66)	2,640 (71)	*2,200 (75)
50	6,720 (58)	5,210 (60.5)	4,270 (62.5)	4,500 (60)	3,730 (64.5)	2,590 (68)	3,140 (63.5)	2,520 (68.5)	2,150 (73)
55	6,430 (54)	5,030 (56.5)	4,130 (58.5)	4,070 (56.5)	3,400 (61.5)	2,360 (64.5)	2,920 (60.5)	2,400 (65.5)	2,080 (69.5)
60	5,510 (50)	4,970 (53)	3,980 (54.5)	3,700 (53)	3,100 (58)	2,220 (61)	2,730 (57.5)	2,280 (62.5)	2,020 (66.5)
65	4,630 (46)	4,630 (48.5)	3,900 (50)	3,450 (49.5)	2,830 (54.5)	2,070 (57)	2,560 (54.5)	2,170 (59)	1,950 (63)
70	3,890 (41.5)	3,890 (44)	3,800 (45.5)	3,310 (45.5)	2,610 (50.5)	1,940 (53)	2,360 (51.5)	2,110 (56)	1,880 (59.5)
75	3,270 (36.5)	3,270 (39)	3,270 (40)	3,170 (41)	2,470 (46.5)	1,880 (48.5)	2,210 (48)	2,040 (52.5)	1,810 (56)
80	2,730 (30.5)	2,730 (33)	2,730 (34)	3,080 (36.5)	2,410 (42)	1,830 (44)	2,140 (44.5)	1,980 (49)	1,730 (52)
85	2,270 (23.5)	2,270 (26)		2,740 (31.5)	2,370 (37)	1,790 (38.5)	2,100 (41)	1,940 (45)	1,670 (47.5)
90	1,860 (12.5)			2,320 (25.5)	2,310 (31.5)	1,770 (32)	2,060 (36.5)	1,900 (40.5)	1,620 (43)
95				1,950 (18.5)	1,950 (24)		2,010 (32)	1,850 (35.5)	1,570 (37.5)
100							1,940 (26.5)	1,780 (30)	1,500 (30.5)
105							1,690 (19)	1,690 (22)	

NOTE: ( ) Boom angles are in degrees.  
\*This capacity is based upon maximum boom angle.

A6-829-008672

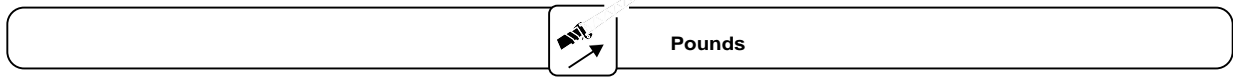
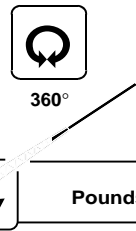
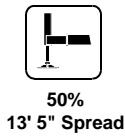
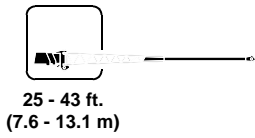

Feet	25 ft. LENGTH			34 ft. LENGTH			43 ft. LENGTH		
	0° OFFSET	15° OFFSET	30° OFFSET	0° OFFSET	15° OFFSET	30° OFFSET	0° OFFSET	15° OFFSET	30° OFFSET
25	*12,500 (75)	*7,300 (75)		*7,700 (75)			*4,500 (75)		
30	10,700 (71.5)	7,170 (74)	*5,250 (75)	7,180 (73)	*4,900 (75)		4,430 (74)		
35	9,230 (68)	6,490 (70.5)	5,080 (73)	6,110 (70)	4,790 (73.5)		3,960 (71.5)	*2,800 (75)	
40	7,370 (65)	5,900 (67.5)	4,730 (69.5)	5,370 (67)	4,360 (70.5)	*3,200 (75)	3,610 (68.5)	2,770 (74)	
45	5,850 (61.5)	5,460 (64)	4,440 (66)	4,870 (63.5)	4,020 (67.5)	2,900 (71.5)	3,360 (66)	2,640 (71)	*2,200 (75)
50	4,670 (58)	4,670 (60.5)	4,270 (62.5)	4,500 (60)	3,730 (64.5)	2,590 (68)	3,140 (63.5)	2,520 (68.5)	2,150 (73)
55	3,740 (54)	3,740 (56.5)	3,740 (58.5)	4,070 (56.5)	3,400 (61.5)	2,360 (64.5)	2,920 (60.5)	2,400 (65.5)	2,080 (69.5)
60	2,990 (50)	2,990 (53)	2,990 (54.5)	3,510 (53)	3,100 (58)	2,220 (61)	2,730 (57.5)	2,280 (62.5)	2,020 (66.5)
65	2,360 (46)	2,360 (48.5)	2,360 (50)	2,870 (49.5)	2,830 (54.5)	2,070 (57)	2,560 (54.5)	2,170 (59)	1,950 (63)
70	1,840 (41.5)	1,840 (44)	1,840 (45.5)	2,330 (45.5)	2,330 (50.5)	1,940 (53)	2,360 (51.5)	2,110 (56)	1,880 (59.5)
75	1,390 (36.5)	1,390 (39)	1,390 (40)	1,860 (41)	1,860 (46.5)	1,860 (48.5)	2,050 (48)	2,040 (52.5)	1,810 (56)
80	1,000 (30.5)	1,000 (33)	1,000 (34)	1,460 (36.5)	1,460 (42)	1,460 (44)	1,690 (44.5)	1,690 (49)	1,690 (52)
85				1,120 (31.5)	1,120 (37)	1,120 (38.5)	1,370 (41)	1,370 (45)	1,370 (47.5)
90							1,090 (36.5)	1,090 (40.5)	1,090 (43)

NOTE: ( ) Boom angles are in degrees.  
\*This capacity is based upon maximum boom angle.

A6-829-012453



25 ft.  
(7.6 m)



10,170 lbs.  
(4613 kg)



100%



360°



\_\_\_\_\_ Pounds



Feet	BOOM ANGLE (Ref.)	CAPACITY (lbs.)
25	75.0	*12,500
30	71.5	10,700
35	68.0	9,230
40	65.0	8,280
45	61.5	7,340
50	58.0	6,720
55	54.0	6,430
60	50.0	6,070
65	46.0	5,180
70	41.5	4,440
75	36.5	3,820
80	30.5	3,280
85	23.5	2,810
90	12.5	2,400

\*This capacity is based upon maximum boom angle.

A6-829-008673



25 ft.  
(7.6 m)



10,170 lbs.  
(4613 kg)



50%  
13' 5" Spread



360°



\_\_\_\_\_ Pounds



Feet	BOOM ANGLE (Ref.)	CAPACITY (lbs.)
25	75.0	*12,500
30	71.5	10,700
35	68.0	9,230
40	65.0	7,760
45	61.5	6,380
50	58.0	5,200
55	54.0	4,270
60	50.0	3,520
65	46.0	2,890
70	41.5	2,360
75	36.5	1,910
80	30.5	1,530
85	23.5	1,190

\*This capacity is based upon maximum boom angle.

A6-829-012329

THIS CHART IS ONLY A GUIDE AND SHOULD NOT BE USED TO OPERATE THE CRANE. The individual crane's load chart, operating instructions and other instructional plates must be read and understood prior to operating the crane.



28 -70 ft.  
(8.5 - 21.3 m)



10,170 lbs.  
(4613 kg)



20.5 x 25  
24 Ply  
Stationary



360°



Pounds

Feet	28	34	40	46	52	58	64	70
10	26,200 (64)	26,200 (69)						
12	19,350 (59.5)	19,350 (65.5)	16,000 (70)					
15	13,200 (51.5)	13,200 (59.5)	13,200 (65)	13,200 (69)				
20	7,910 (36.5)	7,910 (49)	7,910 (57)	7,910 (62)	7,910 (66)	7,400 (69.5)		
25	5,060 (6)	5,060 (36)	5,060 (47.5)	5,060 (54.5)	5,060 (60)	5,060 (64)	5,060 (67)	5,060 (69.5)
30		3,600 (15.5)	3,600 (36.5)	3,600 (46.5)	3,600 (53)	3,600 (58)	3,600 (62)	3,600 (65)
35			2,610 (20)	2,610 (36.5)	2,610 (45.5)	2,610 (51.5)	2,610 (56.5)	2,610 (60)
40				1,890 (23)	1,890 (36.5)	1,890 (45)	1,890 (50.5)	1,890 (55)
45					1,340 (25)	1,340 (37)	1,340 (44.5)	1,340 (49.5)
50						910 (26.5)	910 (37)	910 (43.5)

NOTE: ( ) Boom angles are in degrees.

A6-829-009074

Boom Angle	28	34	40	46
0°	5,030 (25.1)	3,360 (31)	2,300 (37)	1,540 (43)

NOTE: ( ) Reference radii are in feet.

A6-829-009460

WINDY SALE & RENTAL



28 - 70 ft.  
(8.5 - 21.3 m)



10,170 lbs.  
(4613 kg)



20.5 x 25  
24 Ply  
Stationary



Defined Arc  
Over Front  
±6°



Pounds

Feet	28	34	40	46	52	58	64	70
10	28,650 (64)	26,200 (69)						
12	24,950 (59.5)	24,950 (65.5)	21,000 (70)					
15	20,900 (51.5)	20,900 (59.5)	20,900 (65)	16,500 (69)				
20	14,900 (36.5)	14,900 (49)	14,900 (57)	12,200 (62)	12,200 (66)	12,200 (69.5)		
25	9,900 (6)	9,900 (36)	9,900 (47.5)	9,900 (54.5)	9,400 (60)	9,400 (64)	9,400 (67)	9,400 (69.5)
30		7,350 (15.5)	7,350 (36.5)	7,350 (46.5)	7,000 (53)	7,000 (58)	7,000 (62)	7,000 (65)
35			5,660 (20)	5,660 (36.5)	5,660 (45.5)	5,600 (51.5)	5,600 (56.5)	5,600 (60)
40				4,450 (23)	4,450 (36.5)	4,450 (45)	4,450 (50.5)	4,450 (55)
45					3,550 (25)	3,550 (37)	3,550 (44.5)	3,550 (49.5)
50						2,850 (26.5)	2,850 (37)	2,850 (43.5)
55						2,290 (3.5)	2,290 (28)	2,290 (37)
60							1,840 (13)	1,840 (28.5)
65								1,460 (15.5)

NOTE: ( ) Boom angles are in degrees.

A6-829-009073A

Boom Angle	28	34	40	46	52	58	64	70
0°	9,860 (25.1)	6,940 (31)	5,130 (37)	3,880 (43)	2,980 (49)	2,290 (55)	1,760 (61)	1,350 (66.6)

NOTE: ( ) Reference radii are in feet.

A6-829-009460



28 -70 ft.  
(8.5 - 21.3 m)



10,170 lbs.  
(4613 kg)



20.5 x 25 - 24 Ply  
Pick & Carry  
(Up to 2.5 MPH)



Boom Centered  
Over Front



Pounds

Feet	28	34	40	46	52	58	64	70
10	33,800 (64)							
12	29,000 (59.5)							
15	23,600 (51.5)	23,600 (59.5)	23,600 (65)	23,600 (69)				
20	14,900 (36.5)	14,900 (49)	14,900 (57)	14,900 (62)	12,200 (66)	12,200 (69.5)		
25	9,900 (6)	9,900 (36)	9,900 (47.5)	9,900 (54.5)	9,900 (60)	9,400 (64)	9,400 (67)	
30		7,180 (15.5)	7,180 (36.5)	7,180 (46.5)	7,180 (53)	7,180 (58)	7,000 (62)	7,000 (65)
35			5,660 (20)	5,660 (36.5)	5,660 (45.5)	5,660 (51.5)	5,660 (56.5)	5,600 (60)
40				4,450 (23)	4,450 (36.5)	4,450 (45)	4,450 (50.5)	4,450 (55)
45					3,550 (25)	3,550 (37)	3,550 (44.5)	3,550 (49.5)
50						2,850 (26.5)	2,850 (37)	2,850 (43.5)
55						2,290 (3.5)	2,290 (28)	2,290 (37)
60							1,840 (13)	1,840 (28.5)
65								1,460 (15.5)

NOTE: ( ) Boom angles are in degrees.

A6-829-009075

Boom Angle	28	34	40	46	52	58	64	70
0°	8,970 (25.1)	6,870 (31)	5,130 (37)	3,880 (43)	2,980 (49)	2,290 (55)	1,760 (61)	1,350 (66.6)

NOTE: ( ) Reference radii are in feet.

A6-829-009460

# Working range



28 - 70 ft.  
(8.5 - 21.3 m)

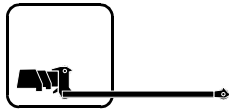

23 ft.  
(7.1 m)

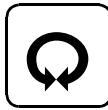
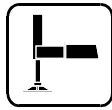

360°

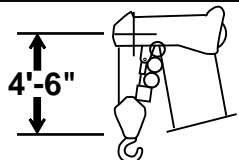
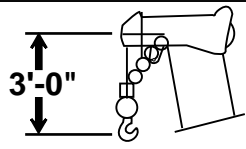
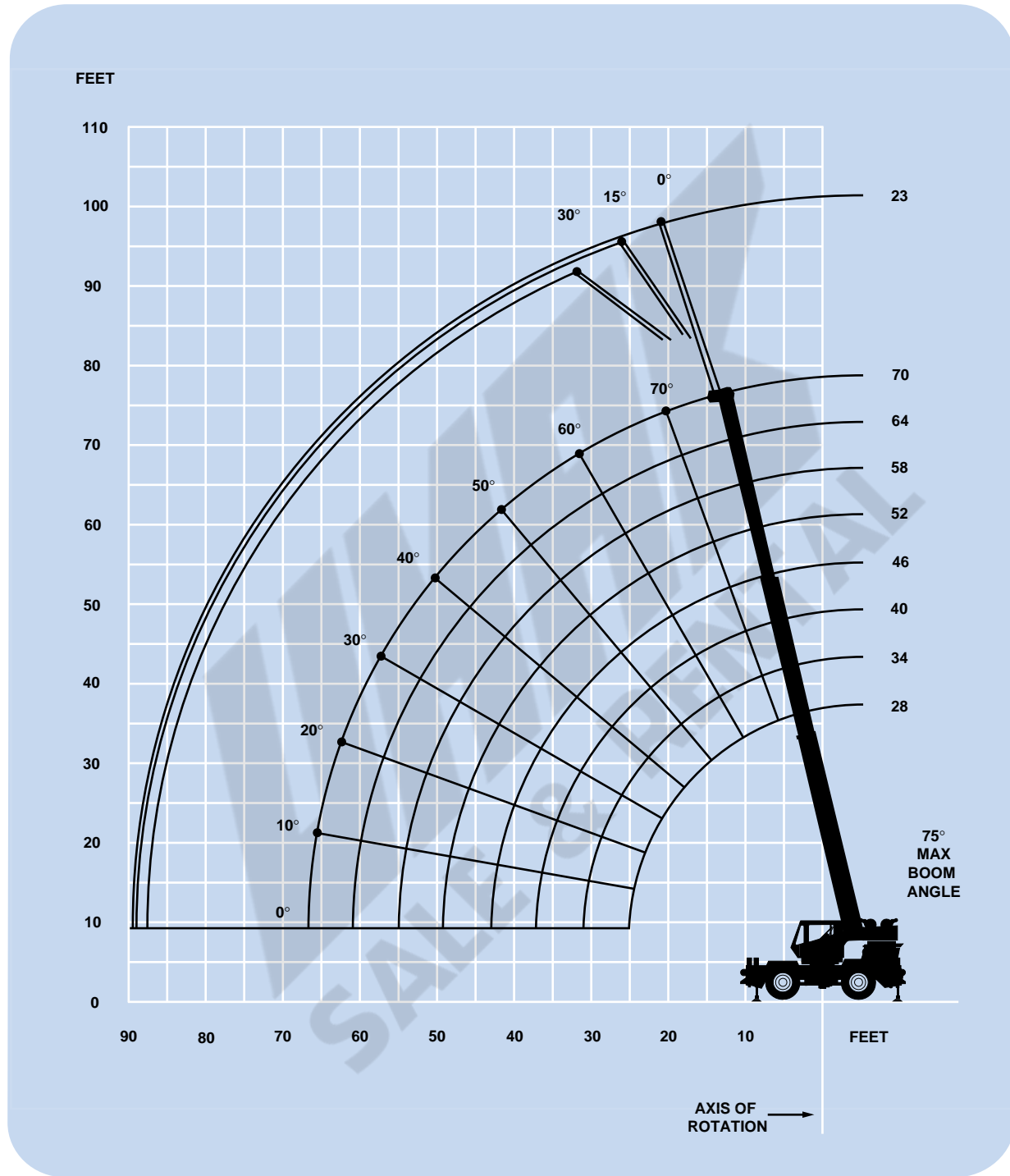

DIMENSIONS ARE FOR LARGEST GROVE FURNISHED HOOK BLOCK AND HEADACHE BALL, WITH ANTI-TWO BLOCK ACTIVATED.

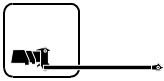

23 ft.  
(7.1 m)



10,170 lbs.  
(4613 kg)



100%



360°



Main Boom Angle	0° OFFSET	15° OFFSET	30° OFFSET
	Cap. in lbs. (Rad. Ref)	Cap. in lbs. (Rad. Ref)	Cap. in lbs. (Rad. Ref)
75	12,000 (27)	7,700 (32.5)	5,070 (35.7)
70	10,400 (33.3)	7,000 (38.1)	4,800 (41.2)
65	8,500 (40.2)	6,300 (44.9)	4,500 (47.8)
60	7,400 (47)	5,450 (51.3)	4,300 (54)
55	6,600 (53.2)	5,000 (57.3)	4,100 (59.8)
50	6,100 (59.2)	4,700 (62.9)	3,900 (65.1)
45	5,160 (64.7)	4,500 (68)	3,800 (69.9)
40	4,410 (69.6)	4,010 (72.6)	3,700 (74.2)
35	3,840 (74)	3,530 (76.6)	3,390 (77.9)
30	3,400 (77.8)	3,160 (80.1)	

NOTE: ( ) Reference radii are in feet.

A6-829-008660

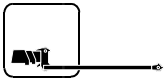

23 ft.  
(7.1 m)



10,170 lbs.  
(4613 kg)



50%  
13' 5" Spread



360°



Main Boom Angle	0° OFFSET	15° OFFSET	30° OFFSET
	Cap. in lbs. (Rad. Ref)	Cap. in lbs. (Rad. Ref)	Cap. in lbs. (Rad. Ref)
75	12,000 (27)	7,700 (32.5)	5,070 (35.7)
70	10,050 (33.3)	7,000 (38.1)	4,800 (41.2)
65	7,580 (40.2)	6,300 (44.9)	4,500 (47.8)
60	5,850 (47)	4,950 (51.3)	4,300 (54)
55	4,610 (53.2)	3,950 (57.3)	3,600 (59.8)
50	3,680 (59.2)	3,210 (62.9)	2,950 (65.1)
45	3,000 (64.7)	2,650 (68)	2,460 (69.9)
40	2,490 (69.6)	2,220 (72.6)	2,090 (74.2)
35	2,100 (74)	1,890 (76.6)	1,790 (77.9)
30	1,800 (77.8)	1,640 (80.1)	

NOTE: ( ) Reference radii are in feet.

A6-829-013238



# Rated lifting capacities

## NOTES FOR LIFTING CAPACITIES

**WARNING: THIS CHART IS ONLY A GUIDE.**  
**The notes below are for illustration only and should not be relied upon to operate the crane.**  
**The individual crane's load chart, operating instructions and other instruction plates must be read and understood prior to operating the crane.**

1. All rated loads meet ANSI/ASME B30.5 Mobile and Locomotive Cranes. Testing and development were performed to SAEJ1063, Cantilevered Boom Crane Structures, Method of Test and SAEJ765 Crane Stability Test Code.

2. Rated loads include the weight of hookblock, slings and auxiliary lifting devices and their weights shall be subtracted from the listed rating to obtain the net load to be lifted. When more than the minimum required hoist reeving is used, the additional rope weight shall be considered part of the load to be handled.

3. Capacities appearing above the bold line are based on structural strength. Tipping should never be relied upon as a capacity indication.





































4. The machine shall be leveled on a firm supporting surface. Depending on the nature of the supporting surface, it may be necessary to have structural supports under the outrigger floats or tires to spread the load to a larger bearing surface.

5. When either boom length or radius or both are between values listed, the smallest load shown at either the next larger radius or next longer or shorter boom length shall be used.

6. Tires shall be inflated to the recommended pressure before lifting on rubber.

7. For outrigger operation, outriggers shall be properly extended with tires raised free of crane weight before operating the boom or lifting loads.

## Symbols Glossary

	Frame		Steering
	Outriggers		Transmission
	Outrigger Controls		Axles
	Engine		Brakes
	Fuel Tank Capacity		Tires
	Electrical System		Suspension
	Drive		Rotation
	Lights		Boom Elevation
	Cab		Swing
	Boom		Counterweight
	Fixed Swingaway		Oil
	Tele-Swingaway		Hydraulic System
	Jib		Hoist
	Boom Nose		Radius
	Boom Extension		Boom Length
	Speed		Hookblock
	Grade		Gear
	Lattice Extension		Luffing Jib

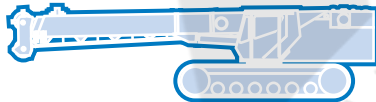
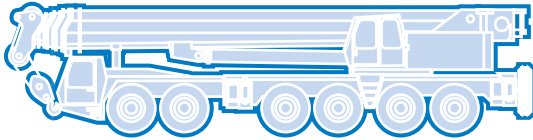
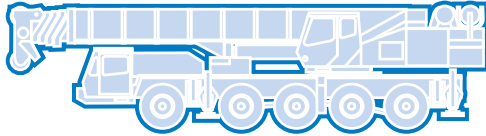
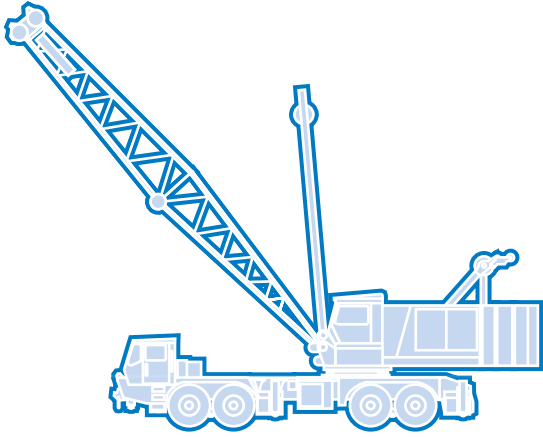

**Grove Worldwide – World Headquarters**

**Grove North America**  
1565 Buchanan Trail East  
P.O. Box 21  
Shady Grove, Pennsylvania 17256, U.S.A.  
Tel: [Int + 1] (717) 597-8121  
Fax: [Int + 1] (717) 597-4062  
Western Hemisphere, Asia/Pacific

**Grove Europe Limited\***  
Sunderland SR4 6TT, England  
Tel: [Int + 44] 191 565-6281  
Fax: [Int + 44] 191 564-0442  
Europe, Africa, Middle East

**Grove Europe Limited\***  
P.O. Box No. 268  
4A Kimber Road  
Abingdon, Oxfordshire, OX141SG  
Tel: [Int + 44] 1235 55-3184  
Fax: [Int + 44] 1235 55-3218

\*Grove Europe Limited, Registered in England,  
Number 1845128, Registered office, Crown Works,  
Pallion, Sunderland, Tyne & Wear, England SR4 6TT

**Deutsche Grove GmbH**  
**Sales and Service**  
Helmholtzstrasse 12, Postfach 5026  
D-40750 Langenfeld, Germany  
Tel: [Int + 49] (2173) 8909-0  
Fax: [Int + 49] (2173) 8909-30

**Wilhelmshaven Works**  
Industriegelände West, Postfach 1853  
D-26358 Wilhelmshaven, Germany  
Tel: [Int + 49] (4421) 294-0  
Fax: [Int + 49] (4421) 294-301

**Grove France S.A.**  
16, chaussée Jules-César, 95520 OSNY  
B.P. 203, 95523 CERGY PONTOISE CEDEX  
France  
Tel: [Int + 33] (1) 30313150  
Int: [Int + 33] (1) 30386085

**Grove Asia/Pacific - Regional Office**  
171 Chin Swee Road  
#06-01 San Centre  
Singapore 0316  
Tel: [Int + 65] 536-6112  
Fax: [Int + 65] 536-6119  
Asia/Pacific, Near East

**Grove China - Representative Office**  
Beijing Suite 6074  
No. 33 East Chang An Avenue  
Beijing, 100004, China  
Tel: [Int + 86] (10) 513-7766  
Fax: [Int + 86] (10) 513-7307

**Grove Product Support**  
Western Hemisphere, Asia/Pacific  
1086 Wayne Avenue  
Chambersburg, Pennsylvania USA  
Tel: [Int + 1] (717) 263-5100  
Fax: [Int + 1] (717) 267-0404

Europe, Africa, Middle East  
Sunderland SR4 6TT, England  
Tel: [Int + 44] 191 565-6281  
Parts Fax: [Int + 44] 191 510-9242  
Service Fax: [Int + 44] 191 510-9560

<http://www.grovetworldwide.com>

Constant improvement and engineering progress make it necessary that we reserve the right to make specification, equipment, and price changes without notice. Illustrations shown may include optional equipment and accessories and may not include all standard equipment.

Distributed By: