

GROVE RT 518

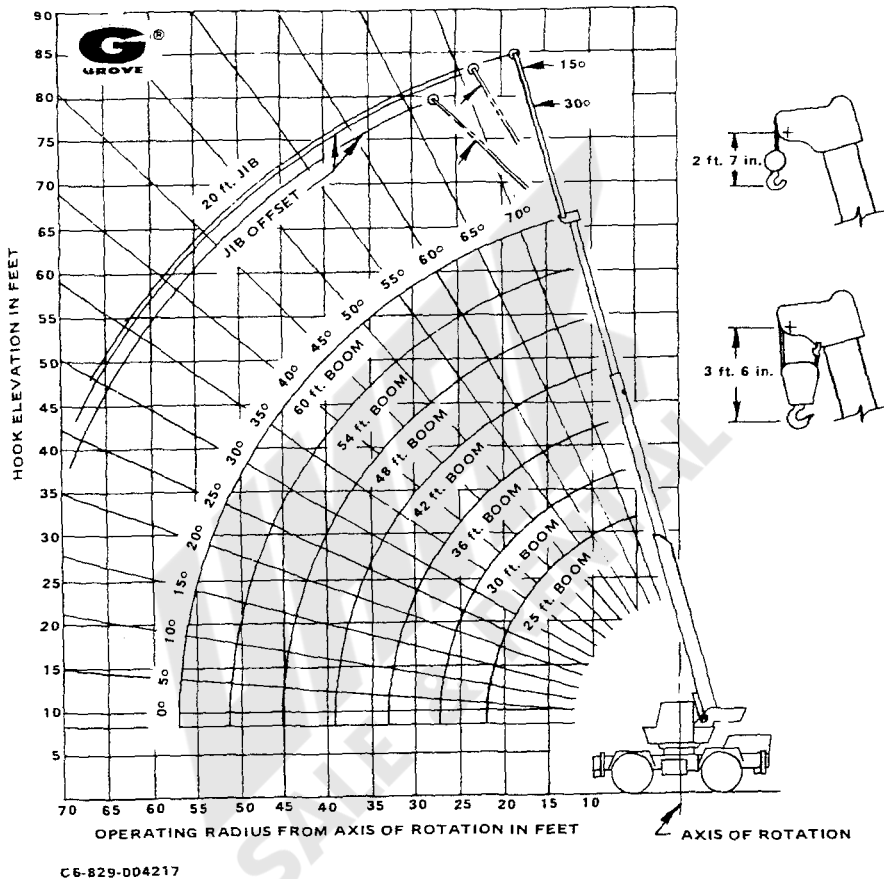

WEIGHT REDUCTIONS FOR LOAD HANDLING DEVICES

20 Ft. A-Frame JIB 25 ft. - 60 ft. BOOM
STOWED 248 lbs.
ERECTED 1,375 lbs.

* Reduction of main boom capacities.

HOOK BLOCKS		
22 Ton, 3 Sheave (12 1/8" OD)	320 lbs.
22 Ton, 3 Sheave (15 7/8" OD)	455 lbs.
15 Ton, 2 Sheave	298 lbs.
12 Ton, 1 Sheave (15 7/8" OD)	400 lbs.
12 Ton, 1 Sheave (12 1/8" OD)	285 lbs.
Auxiliary Boom Head	100 lbs.
5 Ton Headache Ball	150 lbs.

NOTE: All Load Handling Devices and Boom Attachments are Considered Part of the Load and Suitable Allowances MUST BE MADE for Their Combined Weights. Weights are for Grove furnished equipment.

GROVE RT518

18 Ton Capacity 25ft. - 60 ft. Boom

JIB CAPACITY IN POUNDS

20 ft. "A" FRAME JIB

MAIN BOOM ANGLE	0° OFFSET		15° OFFSET		30° OFFSET	
	Radius (Ref) ft.	Cap. lbs.	Radius (Ref) ft.	Cap. lbs.	Radius (Ref) ft.	Cap. lbs.
75°	20.5	9,500	25.7	6,100	28.8	4,200
70	26.2	8,400	31.2	5,450	34.3	3,870
65	32.5	7,140	37.2	4,850	40.0	3,660
60	38.5	6,230	42.8	4,400	45.4	3,500
55	44.2	5,500	48.2	4,150	50.5	3,330
50	49.5	4,430	53.1	3,900	55.2	3,200
45	54.5	3,640	57.6	3,590	59.4	3,080
40	59.0	3,090	61.7	3,050	63.2	2,930
35	63.1	2,730	65.2	2,630	66.4	2,600
30	66.7	2,480	68.3	2,360	69.1	2,350

A6-829-004057

Notes for Jib Capacities

1. All capacities are in pounds. 20 ft. jib may be used for double line lifting service. Capacities are based on structural strength of 20 ft. jib at a given main boom angle regardless of main boom length.
2. **WARNING:** Operation of machine with heavier loads than the capacities listed strictly prohibited. Machine tipping with jib occurs rapidly and without advance warning.
3. Capacities listed are with fully extended outriggers only.
4. **WARNING:** Lifting on rubber with jib is prohibited.
5. Reference radii listed are for fully extended main boom only.
6. No load stability on outriggers with 20 foot jib installed.
 - a. Minimum boom angle for fully extended main boom = 0°.
 - b. Maximum boom length at 0° main boom angle = 80 ft.

LIFTING AREA DIAGRAMS

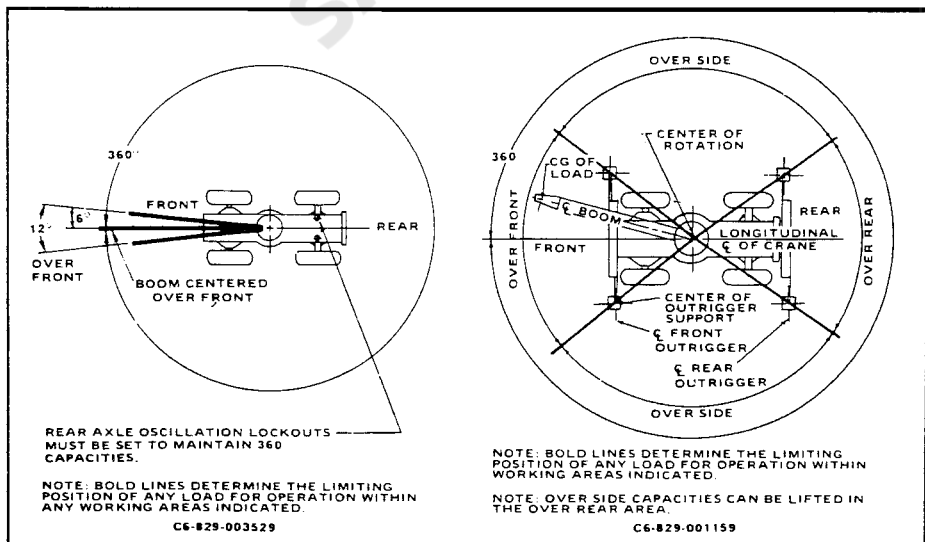

Grove RT518 18 Ton

SCALE 1/16" = 1'-0"

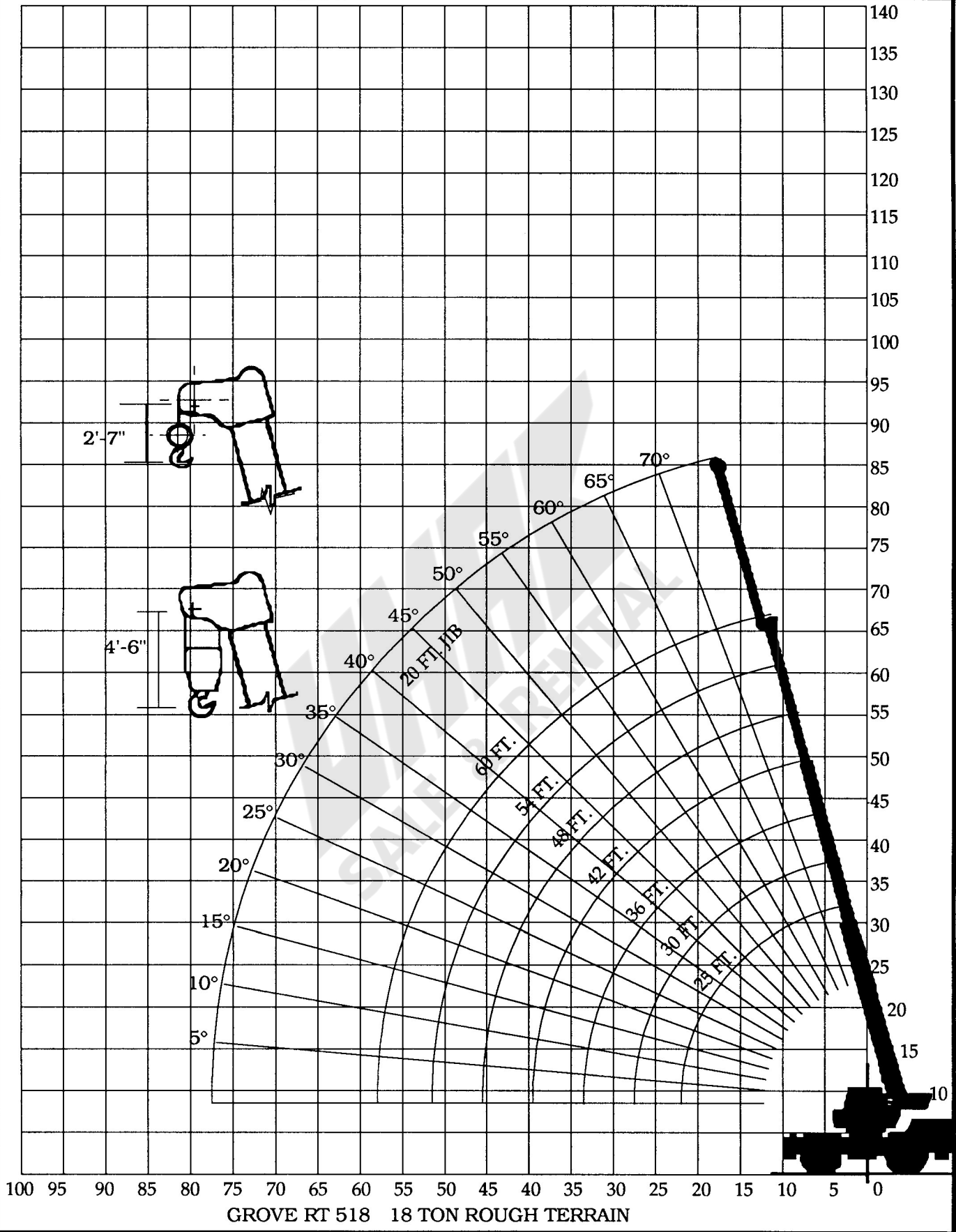

GROVE RT 518 18 TON ROUGH TERRAIN

GROVE 518RT

Rated Lifting Capacities in Pounds

ON OUTRIGGERS FULLY EXTENDED - 360°

Radius in Feet	Main Boom Length in Feet							
	25	30	36	42	48	54	60	
10	36,000 (60)	36,000 (66)	36,000 (70.5)	36,000 (74)				
12	36,000 (54.5)	35,900 (62)	34,600 (67.5)	34,300 (71)	33,500 (74)			
15	30,550 (45)	30,500 (55)	29,300 (62)	28,400 (66.5)	28,000 (70)	27,600 (73)	25,000 (75.5)	
20	22,950 (23.5)	22,950 (41.5)	22,950 (52)	22,650 (59)	22,200 (63.5)	21,900 (67.5)	21,500 (70.5)	
25		18,160 (23)	18,160 (41)	18,160 (50.5)	18,160 (56.5)	17,800 (61.5)	17,400 (65)	
30	See Warning Note 16		13,020 (25.5)	13,020 (40.5)	13,020 (49)	13,020 (55)	13,020 (59.5)	
35				10,020 (27.5)	10,020 (40)	10,020 (48)	10,020 (53.5)	
40					7,910 (28.5)	7,910 (40)	7,910 (47)	
45						6,560 (30)	6,560 (39.5)	
50						5,510 (13.5)	5,510 (30)	
55							4,590 (16.5)	
Min. Boom Angle (deg.) for indicated length [No Load]							0	
Max. Boom Length (ft.) at 0 deg. boom angle [No Load]							60.0	

NOTE: Boom Angles are in degrees.

A6-829-003855 & -003404A

ON OUTRIGGERS FULLY EXTENDED - OVER FRONT

Radius in Feet	Main Boom Length in Feet							
	25	30	36	42	48	54	60	
10	36,000 (60)	36,000 (66)	36,000 (70.5)	36,000 (74)				
12	36,000 (54.5)	35,900 (62)	34,600 (67.5)	34,300 (71)	33,500 (74)			
15	30,550 (45)	30,500 (55)	29,300 (62)	28,400 (66.5)	28,000 (70)	27,600 (73)	25,000 (75.5)	
20	22,950 (23.5)	22,950 (41.5)	22,950 (52)	22,650 (59)	22,200 (63.5)	21,900 (67.5)	21,500 (70.5)	
25		18,350 (23)	18,350 (41)	18,350 (50.5)	18,300 (56.5)	17,800 (61.5)	17,400 (65)	
30	See Warning Note 16		15,200 (25.5)	15,200 (40.5)	15,200 (49)	15,200 (55)	14,850 (59.5)	
35				12,080 (27.5)	12,080 (40)	12,080 (48)	12,080 (53.5)	
40					9,630 (28.5)	9,630 (40)	9,630 (47)	
45						7,960 (30)	7,960 (39.5)	
50						6,720 (13.5)	6,720 (30)	
55							5,680 (16.5)	
Min. Boom Angle (deg.) for indicated length [No Load]							0	

RATED LIFTING CAPACITIES IN POUNDS

14.00x24 TIRES

Radius in Feet	Stationary Capacity	Stationary Capacity	Pick & Carry Cap. Up to 2.5 MPH
	Defined Arc(3) Over Front	360° Arc	Boom Centered(7) Over Front
10	30,510 (a)	20,510 (a)	23,330 (a)
12	23,360 (a)	15,100 (a)	22,310 (a)
15	19,610 (a)	11,470 (a)	16,430 (a)
20	13,280 (c)	6,540 (c)	12,670 (a)
25	9,500 (c)	4,310 (c)	9,500 (b)
30	7,090 (c)	3,030 (c)	6,460 (c)
35	5,540 (d)	2,170 (d)	5,330 (d)
40	4,290 (e)	1,550 (e)	4,290 (e)
45	3,360 (f)	1,260 (f)	3,360 (f)
50	2,640 (g)		2,640 (g)
55	1,990 (g)		1,990 (g)

A6-829-003937

ON RUBBER CAPACITIES

16.00x25 TIRES

Radius in Feet	Stationary Capacity	Stationary Capacity	Pick & Carry Cap. Up to 2.5 MPH
	Defined Arc (3) Over Front	360° Arc	Boom Centered(7) Over Front
10	34,210 (a)	21,990 (a)	28,500 (a)
12	26,240 (a)	16,290 (a)	26,390 (a)
15	22,110 (a)	11,660 (a)	22,180 (a)
20	13,840 (c)	6,930 (c)	13,840 (a)
25	9,650 (c)	4,570 (c)	9,000 (b)
30	7,240 (c)	3,160 (c)	7,240 (c)
35	5,720 (d)	2,280 (d)	5,720 (d)
40	4,410 (e)	1,630 (e)	4,410 (e)
45	3,440 (f)	1,080 (f)	3,440 (f)
50	2,800 (g)		2,800 (f)
55	2,240 (g)		2,240 (g)

A6-829-003935

20.5x25 TIRES

Radius in Feet	Stationary Capacity	Stationary Capacity	Pick & Carry Cap. Up to 2.5 MPH
	Defined Arc (3) Over Front	360° Arc	Boom Centered (7) Over Front
10	33,900 (a)	22,000 (a)	28,300 (a)
12	26,000 (a)	17,400 (a)	25,210 (a)
15	21,900 (a)	11,520 (a)	20,180 (a)
20	13,670 (c)	7,010 (c)	13,670 (a)
25	9,950 (c)	4,620 (c)	7,860 (b)
30	7,410 (c)	3,190 (c)	6,290 (c)
35	5,670 (d)	2,240 (d)	5,060 (d)
40	4,370 (e)	1,610 (e)	4,060 (e)
45	3,440 (f)	1,120 (f)	3,290 (f)
50	2,770 (g)		2,720 (f)
55	2,150 (g)		2,150 (g)

A6-829-003933

NOTES FOR RUBBER CAPACITIES

- Capacities do not exceed 85% of tipping loads as determined by test in accordance with SAE J-765.
- Capacities are applicable to machines equipped with:

Cold Inflation	2.5 MPH
115 PSI	110 PSI
95 PSI	80 PSI
80 PSI	65 PSI

- Defined Arc - Over front includes $\pm 6^\circ$ on either side of longitudinal centerline of machine.
- Capacities appearing above bold line are based on structural strength and tipping should not be relied upon as a capacity limitation.
- Capacities are applicable only with machine on a firm level surface.
- On rubber lifting with jib not permitted.
- For pick and carry operation, boom must be centered over front of machine and mechanical swing lock engaged. When handling loads in the structural range with capacities close to maximum ratings, travel should be reduced to creep speed.
- Axle lockouts must be functioning before lifting on rubber. (Check automatic lockout system for proper functioning: Refer to "Operation and Maintenance Manual" for description of a proper functioning axle lockout system).
- All lifting depends on proper tire inflation, capacity and condition. Capacities must be reduced for lower tire inflation pressures. See lifting capacity chart for tire used. Damaged tires are hazardous to safe operation of crane.

A6-829-003743

MAXIMUM PERMISSIBLE BOOM LENGTH:

(a) 24.8 ft.	(e) 48 ft.
(b) 30 ft.	(f) 54 ft.
(c) 36 ft.	(g) 60 ft.
(d) 42 ft.	

Main Boom 60 ft.	Main Boom w/20 ft. JIB
0	0
60 ft.	80 ft.
0	45
60 ft.	58 ft.

Front (No Load)	Minimum boom angle for indicated boom length	0	0
360	Maximum boom length at 0 boom angle	60 ft.	80 ft.
(No Load)	Minimum boom angle for indicated boom length	0	45
(No Load)	Maximum boom length at 0 boom angle	60 ft.	58 ft.

GROVE 518RT

LIFTING CAPACITY NOTES

GENERAL:

1. Rated loads as shown on lift chart pertain to this machine as originally manufactured and equipped. Modifications to the machine or use of optional equipment other than that specified can result in a reduction of capacity.
2. Construction equipment can be hazardous if improperly operated or maintained. Operation and maintenance of this machine shall be in compliance with the information in the operator's, parts, and safety manuals supplied with this machine. If these manuals are missing, order replacements from the manufacturer through the distributor.
3. The operator and other personnel associated with this machine shall fully acquaint themselves with the latest applicable American National Standards Institute (ANSI) Safety Standards for cranes.

SETUP:

1. The machine shall be leveled on a firm supporting surface. Depending on the nature of the supporting surface, it may be necessary to have structural supports under the outrigger floats or tires to spread the load to a larger bearing surface.
2. For outrigger operation, outriggers shall be fully extended with tires raised free of crane weight before operating the boom or lifting loads.
3. If machine is equipped with front jack cylinder, the front jack cylinder shall be set in accordance with written procedure.
4. If machine is equipped with extendable counterweight, the counterweight shall be fully extended before operation.
5. Tires shall be inflated to the recommended pressure before lifting on rubber.
6. With certain boom and hoist tackle combinations, maximum capacities may not be obtainable with standard cable lengths.

OPERATION:

1. Rated loads at rated radius shall not be exceeded. Do not tip the machine to determine allowable loads. For clamshell or concrete bucket operation, weight of bucket and load must not exceed 80% of rated lifting capacities.
2. Rated loads do not exceed 85% of the tipping load as determined by SAE Crane Stability Test Code J-765a.
3. Rated loads include the weight of hook block, slings and auxiliary lifting devices and their weights shall be subtracted from the listed ratings to obtain the net load to be lifted.
4. Load ratings are based on freely suspended loads. No attempt shall be made to move a load horizontally on the ground in any direction.
5. Rated loads do not account for wind on lifted load or boom. It is recommended when wind velocity is above 20 mph (32 km/h), rated loads and boom lengths shall be appropriately reduced.

6. Rated loads are for lift crane service only.
7. Do not operate at a radius or boom length where capacities are not listed. At these positions, the machine may overturn without any load on the hook.
8. The maximum load which can be telescoped is not definable because of variations in loadings and crane maintenance, but it is safe to attempt retraction and extension within the limits of the capacity chart.
9. When either boom length or radius or both are between values listed, the smallest load shown at either the next larger radius or boom length shall be used.
10. For safe operation, the user shall make due allowances for his particular job conditions, such as: soft or uneven ground, out of level conditions, high winds, side loads, pendulum action, jerking or sudden stopping of loads, hazardous conditions, experience of personnel, two machine lifts, traveling with loads, electric wires, etc. Side pull on boom or jib is extremely dangerous.
11. Power telescoping boom sections must be extended equally at all times.
12. Handling of personnel from the boom is not authorized except with equipment furnished and installed by Grove Manufacturing Company.
13. Keep load handling devices a minimum of 12 inches (30 cm) below boom head when lowering or extending boom.
14. Loaded boom angles give an approximation of the operating radius at specified boom lengths. The boom angle before loading should be greater to account for deflection.
15. Capacities appearing above bold line are based on structural strength and tipping should not be relied upon as a capacity limitation.
16. Capacities for 25 ft. (7.5 m) boom length shall be lifted with the boom fully retracted. If boom is not fully retracted, capacities shall not exceed those shown for the 30 ft. (9.1 m) boom length.

DEFINITIONS:

1. Operating Radius: Horizontal distance from a projection of the axis of rotation to the supporting surface before loading to the center of the vertical hoist line or tackle with load applied.
2. Loaded Boom Angle (Shown in Parenthesis on Main Boom Capacity Chart): is the angle between the boom base section and the horizontal, after lifting the rated load at the rated radius.
3. Working Area: Areas measured in a circular arc about the center line of rotation as shown on the working area diagram.
4. Freely Suspended Load: Load hanging free with no direct external force applied except by the lift cable.
5. Side Load: Horizontal force applied to the lifted load either on the ground or in the air.

RT518

SPECIFICATIONS



GROVE MANUFACTURING COMPANY

Division of Walter Kidde & Company, Inc.

KIDDE

SHADY GROVE, PA. 17256





SUPERSTRUCTURE SPECIFICATIONS

BOOM – 25 ft. – 60 ft. (7.5m – 18.2m); 3-section Trapezoidal†-shaped full power mechanically synchronized main boom.

*24 ft. – 42 ft. (7.4m – 12.7m); 2-section Trapezoidal†-shaped full power main boom. Boom extension is composed of a 5 in. (127mm) dia. bore double-acting cylinder with integral holding valve.

*28 ft. – 70 ft. (8.6m – 21.2m); 3-section Trapezoidal†-shaped full power mechanically synchronized main boom.

Boom extension for 3-section booms is composed of a 6½ in. (165mm) bore, double-acting telescope cylinder with integral holding valve which extends the mid section. Fly section is mechanically extended by a ¾ in. (22mm) dia. cable attached to the mid section which insures positive synchronization at all boom lengths. Extension cable is supported by two 14¾ in. (378mm) tread dia., metallic sheaves which are attached to the outer end of the mid section. A separate ¾ in. (19mm) dia. cable is provided for boom retraction.

Boom telescope sections are supported on Nylatron wear pads. Side adjustable wear pads prevent metal-to-metal contact of inner boom sections and permit ease of boom side alignment. *A cable extension system is offered to comply with certain international market requirements consisting of a 1½ in. (29mm) dia. extension cable and two 24¾ in. (629mm) tread dia. metallic supporting sheaves.

***JIBS** – 23 ft. – 38 ft. (7.1m – 11.6m) telescoping "A"-frame for 28 ft. – 70 ft. (8.6m – 21.2m) boom. Jib can be adjusted from 23 ft. (7.1m), retracted length to 33 ft. (10.1m) and 38 ft. (11.6m) lengths. 23 ft. (7.1m) "A"-frame for 28 ft. – 70 ft. (8.6m – 21.2m) boom. 20 ft. (6.1m) "A"-frame for 24 ft. – 42 ft. (7.4m – 12.7m) and 25 ft. – 60 ft. (7.5m – 18.2m) booms. "A"-frame section attaches to boom nose and stows beneath the main boom for travel. Jibs can be set at offsets of 0°, 15° and 30°. Jibs include jib backstops, single rope self-equalizing suspension, removable pin-type rope guard and a single 13¾ in. (349mm) tread dia. metallic sheave.

BOOM NOSE – Reinforced hi-strength steel construction. Three metallic load bearing sheaves, 10½ in. (270mm) tread dia., mounted on heavy duty tapered roller bearings. One (*two with auxiliary hoist and/or jib) metallic floating idler sheave, 10½ in. (270mm) tread dia., mounted on bronze bushing. Removable pin-type rope guards for easy reeving. Rope dead ends on either side of boom nose.

*A boom nose is offered to comply with certain international market requirements consisting of three metallic load bearing sheaves, 13¾ in. (349mm) tread dia., and one (*two with auxiliary hoist and/or jib) metallic floating idler sheave, 13¾ in. (349mm) tread dia.

***AUXILIARY BOOM NOSE** – Removable single metallic load bearing sheave, 13¾ in. (349mm) tread dia., mounted to main boom nose for single part line work. Equipped with removable pin-type rope guard.

BOOM ELEVATION – Two double-acting 8¾ in. (210mm) dia. bore, 36 in. (914mm) stroke cylinders with integral holding valves provide elevation from 0° to 75°. Pendulum-type boom angle indicator mounted on left side of base boom section. (*Electronic, in-cab, boom angle indicator).

SWING – Grove planetary speed reducer powered by a high torque, low RPM hydraulic orbit motor providing smooth, precise 360° continuous rotation. Equipped with Grove "glide swing" with foot-activated multiple disc swing brake for precision stopping. Electric/hydraulic swing parking brake, hand operated plunger-type house lock or *hand-operated 360° positive swing lock controlled from operator's cab. Externally driven sealed ball bearing with pinion guard. Precision machined bearing mounting surface prevents distortion of swing circle bearing. Maximum speed 3.3 RPM. (*non-free swing w/auto. multi-disc brake available).

CAB – One-man turntable-mounted on vibration and shock absorbing rubber grommets, fully enclosed, all-steel. Full vision with tinted tempered safety glass (except removable front windshield and hinged skylight which are tinted laminated safety glass). Hinged skylight, sliding left side door and sliding right side window for ventilation. Dash-mounted control levers, combination hand and foot controls for boom elevation and engine throttle, outrigger sight level bubble, electric windshield wiper, electric horn, door and window locks, dome light, dash light, 2½ lbs. (1.25kg) dry type fire extinguisher, cab mounted worklight. (*Electronic boom angle indicator with adjustable high and low angle presets and A/V warning, *20,000 BTU/hr. diesel fuel heater, *defroster fan, *windshield washer, *manual skylight wiper, and *sound suppression, *tachometer, *seat belt, *cab spotlight).

CONTROLS – Left of steering wheel are dash-mounted, hand-operated control levers for swing, boom telescope and rear axle steering; at right are control levers for boom elevation, *auxiliary hoist and main hoist. Foot-operated controls consist of dynamic swing brake, boom elevation, service brakes and engine throttle. Operator's right hand console includes transmission gear selection, high-low range selection, hand-operated engine throttle, outrigger sequence controls, emergency parking brake, outrigger sight level bubble, *heater controls, console panel lights, engine start/stop. Additional dash-mounted controls include *electric oscillation lockout override, worklights and master ignition, electric horn integral with steering wheel.

CAB INSTRUMENTATION – Engine oil pressure, engine water temperature (except Deutz Diesel), voltmeter, transmission/converter oil temperature and electric fuel gauge. *Emergency steer indicator, *rear wheel alignment indicator. A/V warnings for low air system pressure, and *engine low oil pressure and high water temperature. (Cylinder head temperature gauge and V-belt failure indicator for optional air-cooled Deutz engine.) All gauges are international type.

COUNTERWEIGHT – Removable, bolted to turntable mast, stationary. Weight varies dependent on boom & hoist configuration (refer to Axle Weight Distribution Chart).

***LOAD MOMENT – ANTI-TWO BLOCK SYSTEM (KRUGER)** – Audio-visual warning in combination with control lever lockout† of: hoist up, telescope out and boom down crane functions. Kruger LMI control console provides operator with display of boom length and load moment. A separate Grove anti-two block system can be obtained independent of the complete Kruger LMI, and is available with audio-visual warning only or audio-visual warning in combination with Grove control lever lockout† of hoist up, telescope out and boom down crane functions.

† Patented Grove feature or patent pending.

* Denotes Optional Equipment

HOIST SPECIFICATIONS

Description: Power up and down, equal speed, planetary reduction with integral automatic brake.
 *Electronic hoist drum rotation indicator.

HOIST DATA	MAIN HOIST Grove Model HO-15H-18B		*MAIN/OR AUXILIARY HOIST ♦ (Controlled Free Fall) Gearmatic Model 25 SGEGR		* MAIN HOIST Grove Model HO-15H-11B	*AUXILIARY HOIST Grove Model HO-15S-11B
Drum Dimensions	12 in. diameter (305mm) 16 in. length (406mm) 17.5 in. flange diameter (445mm)		9 in. diameter (229mm) 13 in. length (330mm) 17.5 in. flange diameter (445mm)		12 in. diameter (305mm) 11 in. length (279mm) 17.5 in. flange diameter (445mm)	12 in. diameter (305mm) 11 in. length (279mm) 17.5 in. flange diameter (445mm)
Performance:			Main Hoist Auxiliary Hoist			
Max. Single Line Speed	1/2 in. (13mm) dia. rope	5/8 in. (16mm) dia. rope	134 FPM (40.8m/min)	155 FPM (47.2m/min)	287 FPM (87.5m/min)	154 FPM (47m/min)
Bare Drum	287 FPM (87.5m/min)	287 FPM (87.5m/min)	186 FPM (56.7m/min)	220 FPM (67.1m/min)	340 FPM (103.6m/min)	183 FPM (57.3m/min)
Mean Drum	340 FPM (103.6m/min)	327 FPM (99.7m/min)	248 FPM (75.6m/min)	290 FPM (88.4m/min)	383 FPM (116.7m/min)	206 FPM (62.8m/min)
Full Drum	383 FPM (116.7m/min)	379 FPM (115.5m/min)				
Max. Single Line Pull						
Bare Drum	9165 lbs. (4157kg)	9165 lbs. (4157kg)	9145 lbs. (4148kg)	9145 lbs. (4148kg)	9165 lbs. (4157kg)	9165 lbs. (4157kg)
Mean Drum	7730 lbs. (3506kg)	8025 lbs. (3640kg)	7105 lbs. (3222kg)	7105 lbs. (3222kg)	7285 lbs. (3560kg)	7285 lbs. (3304kg)
Full Drum	6890 lbs. (3125kg)	6930 lbs. (3143kg)	5065 lbs. (2297kg)	5065 lbs. (2297kg)	6890 lbs. (3125kg)	6890 lbs. (3125kg)
Drum Rope Capacity	720 ft. of 1/2 in. dia. rope (219.6m of 13mm)	480 ft. of 5/8 in. dia. rope (146.3m of 16mm)	680 ft. of 1/2 in. dia. rope (207.3m of 13mm)	550 ft. of 1/2 in. dia. rope (167.6m of 13mm)	485 ft. of 1/2 in. dia. rope (147.8m of 13mm)	485 ft. of 1/2 in. dia. rope (147.8m of 13mm)
++Max. Usable	585 ft. of 1/2 in. dia. rope (178m of 13mm)	365 ft. of 5/8 in. dia. rope (111.3m of 16mm)			395 ft. of 1/2 in. dia. rope (120.4m of 13mm)	395 ft. of 1/2 in. dia. rope (120.4m of 13mm)
Permissible Single Line Rope Pull w/ 3.5:1 Safety Factor	1/2 in. (13mm) dia. 6x37 class 7600 lbs. (3447kg)	5/8 in. (16mm) dia. 6x37 class 7926 lbs. (3595kg)	1/2 in. (13mm) dia. 6x37 class 7600 lbs. (3447kg)	1/2 in. (13mm) dia. 19x7 class 6150 lbs. (2790kg)	1/2 in. (13mm) dia. 6x37 class 7600 lbs. (3447kg)	1/2 in. (13mm) dia. 6x37 class 7600 lbs. (3447kg)
	1/2 in. (13mm) dia. 19x7 class 6150 lbs. (2790kg)	5/8 in. (16mm) dia. 19x7 class 7926 lbs. (3595kg)			1/2 in. (13mm) dia. 19x7 class 6150 lbs. (2790kg)	1/2 in. (13mm) dia. 19x7 class 6150 lbs. (2790kg)

Notes:

- *Denotes Optional Equipment.
- +6th layer of rope not recommended for hoisting operations (9th layer for Gearmatic Model 25 hoist; 5th layer for Grove Model HO-15H-18B with 5/8 in. (16mm) dia. rope
- ++With wire rope minimum 1/2 in. (13mm) below top of drum flange.
- ♦Controlled free fall hoist option available for main or auxiliary hoist, not both.
- 19x7 is a non-spin rope intended for single line operation and is not recommended for multiple part reeving.

SMOOTH, POSITIVE SYNCHRONIZATION*

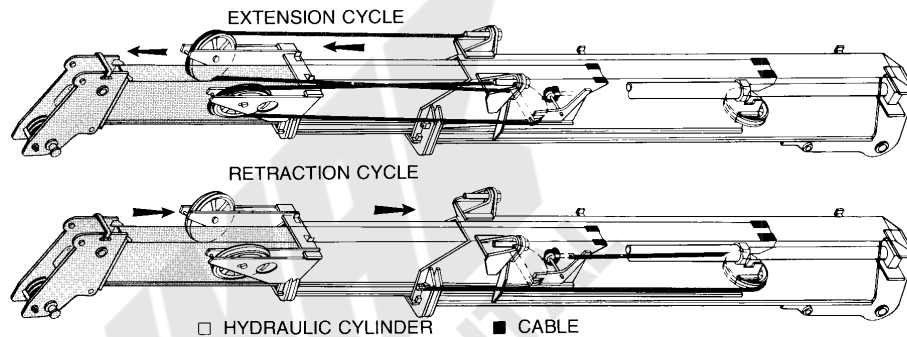

EXTENSION CYCLE – As the mid-section is extended by the telescope cylinder, the fly section is pulled out of the mid-section in direct proportion by a 2/3 in. (22mm) cable. The extension cable has a safety factor of 3.5 to 1 (6 to 1 with international version and 1 1/8 in. (29mm) dia. cable) and is attached with threaded connections at base section and retained on either side of the sheave segment by swaged collars. This prevents the boom from retracting should the cable break.

RETRACTION CYCLE – As the telescope cylinder retracts the mid-section, the fly section is retracted proportionally by a 3/4 in. (19mm) cable attached to the inside of the fly section, threaded around a sheave attached to the base of the mid-section and anchored to the base section.
 *For 25 ft. – 60 ft. (7.5m - 18.2m) boom and optional 28 ft. – 70 ft. (8.6m – 21.2m) boom.



DIMENSIONS

TAIL SWING

- 8' 6" (2591) [w/24 – 42 ft. (7.4 – 12.7m) boom w/o aux. hoist]
- 10' 3 1/8" (3127) [w/28 – 70 ft. (8.6 – 21.2m) and 25 – 60 ft. (7.5 – 18.2m) booms with or w/o aux. hoist, and 24 – 42 ft. (7.4 – 12.7m) boom w/aux. hoist]

TURNING RADIUS

- 17' (5182) (4 wheel steer)

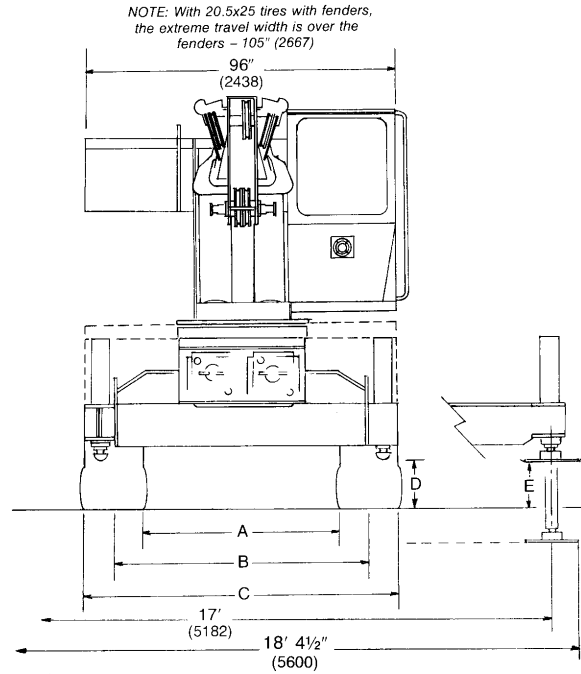

DIMENSIONAL DRAWING

Tire Size	A	B	C	D	E	F	G	H	J	AUXILIARY HOIST	K
*14:00x24 (1607)	63 1/4" (2019)	79 1/2" (2438)	96" (2438)	16 5/8" (422)	14 1/4" (362)	22°	20°	10' 7 5/8" (3242)	24 7/8" (632)	15S-11B	8' 10 1/4" (2699)
16:00x25 (1499)	59" (1969)	77 1/2" (1969)	96" (2438)	18 1/2" (470)	13 3/8" (340)	24°	23°	10' 9 3/4" (3296)	27" (686)	GEARMATIC MODEL 25	9' 1 1/16" (2770)
*20.5x25 (1480)	58 1/4" (2061)	81 1/8" (2061)	105" (2667)	19 1/2" (495)	14 3/8" (365)	17°	16°	10' 9 1/2" (3289)	26 3/4" (680)		

BOOM LENGTH	L	M
*24' – 42' 2-section (7.2m - 12.7m)	32' 4 1/2" (9868)	11' 10 13/16" (3627)
25' – 60' 3-section (7.5m - 18.2m)	33' 0" (10 058)	12' 6 5/16" (3818)
*28' – 70' 3-section (8.6m – 21.2m)	36' 4" (11 074)	15' 10 5/16" (4850)

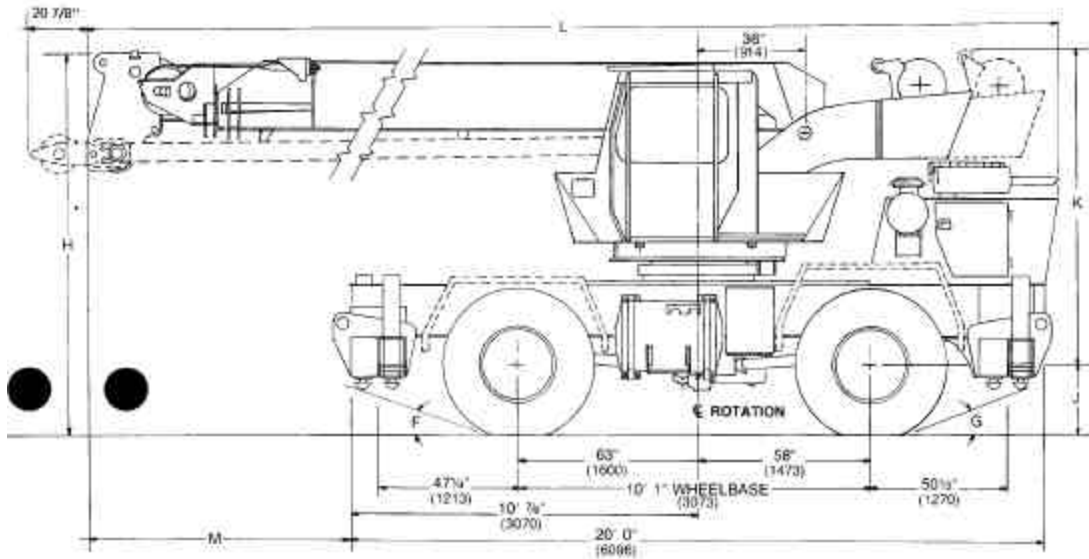

ENGINE SPECIFICATIONS

MAKE & MODEL	Detroit Diesel 4-53N	*Cummins V378-145	*Caterpillar 3208	*Deutz F6L912
TYPE	4 Cylinder O.H.V.	6 Cylinder O.H.V.	8 Cylinder O.H.V.	6 Cylinder O.H.V.
BORE	3.875 in. (98.4mm)	4.625 in. (117.5mm)	4.5 in. (114.3mm)	3.937 in. (100.0mm)
STROKE	4.90 in. (114.3mm)	3.75 in. (95.3mm)	5.0 in. (127.0mm)	4.724 in. (120.0mm)
DISPLACEMENT	212 cu. in. (3475cm ³)	378 cu. in. (6915cm ³)	636 cu. in. (10424cm ³)	345 cu. in. (5656cm ³)
HORSEPOWER (NET)	115 @ 2800	121 @ 2800	121 @ 2800	114 @ 2850
GOVERNED RPM	2800	2800	2800	2650
TORQUE (NET)	246 ft. lbs. (34kg.m) @ 1800	250 ft. lbs. (34.6kg.m) @ 1800	279 ft. lbs. (38.6kg.m) @ 1400	240 ft. lbs. (33.2kg.m) @ 1500
ELECTRICAL SYSTEM	12 Volt, Negative Ground	12 Volt, Negative Ground	12 Volt, Negative Ground	12 Volt, Negative Ground
STARTING SYSTEM	24 Volt	24 Volt	24 Volt	24 Volt
COMBUSTION SYSTEM	2 Cycle w/blower	4 Cycle, Naturally Aspirated	4 Cycle, Naturally Aspirated	4 Cycle, Naturally Aspirated
COOLING SYSTEM (CAP.)	Liquid - 9.4 gal. (35.5 liters)	Liquid - 8.6 gal. (36.4 liters)	Liquid - 13.1 gal. (50.6 liters)	Air Cooled
FUEL CAPACITY	60 gal. (227 liters)	60 gal. (227 liters)	60 gal. (227 liters)	60 gal. (227 liters)
ALTERNATOR	90 AMP	90 AMP	90 AMP	90 AMP
BATTERY	*(2) 625 CCA @ 0°F	*(4) 625 CCA @ 0°F	*(4) 625 CCA @ 0°F	*(2) 625 CCA @ 0°F
AIR CLEANER	Dry Type	Dry Type	Dry Type	Dry Type
AIR COMPRESSOR	12 CFM	13.2 CFM	12 CFM	7.5 CFM
* HOURMETER	Standard	Standard	Standard	Standard

SALE & RENTAL



CHASSIS SPECIFICATIONS

MAIN FRAME – All welded box-type construction braced with cross-members. High-strength steel frame is reinforced at critical points to insure a rigid turntable mounting. Front and rear combination lifting/towing and tie-down lugs are integral with the main frame.

OUTRIGGERS – Front and rear hydraulic double-box integral with main frame; telescoping beams extend to 17 ft. (5.2m) center-to-center and retract to 8 ft. (2.4m) by 3 in. (76mm) bore double-acting cylinders. 21 in. (533mm) stroke 5.5 in. (140mm) bore double-acting vertical jacks with integral check valves for quick leveling on uneven terrain. Vertical jacks equipped with removable, stowable, lightweight, high strength 16.5 in. (419mm) square steel floats. All outrigger controls mounted in operator's cab. Required sequence control arrangement eliminates unintentional outrigger actuation. In addition to the standard integral holding valves and, for added security, the exclusive Grove *Spin-lock is offered, which permits the outrigger vertical jack to be mechanically locked in any position throughout its stroke.

TRANSMISSION & TORQUE CONVERTER – Remote-mounted full powershift transmission with rear axle disconnect. Engine mounted converter, 2.15:1 stall ratio with PTO drive for hydraulic pumps.

SPEEDS – 6 forward and 6 reverse.

- 4 x 4 (3-speeds – high range – 2-wheel drive)
(3-speeds – low range – 4-wheel drive)
- *4 x 2 (3-speeds – high range – 2-wheel drive)
(3-speeds – low range – 2-wheel drive)

AXLES – Front – Planetary drive/steer type mounted rigid to frame. Total reduction ratio 19.03:1.
Rear: (4 x 4) planetary drive/steer type. Total reduction ratio 19.03:1. *No-spin differential offered.
*(4 x 2) steering, non-driving type.
Both standard driving (4 x 4) and optional non-driving (4 x 2) rear axles are pivot mounted to allow 0 in. to 10 in. (254mm) oscillation for rough terrain negotiation.

HYDRAULIC OSCILLATION LOCKOUT – Automatic, full hydraulic on rear axle permits rear axle oscillation only with boom centered in the over front position. Automatic axle lockout assures a rigid lifting platform when lifting on-rubber over-the-side. *(Manually activated electric override control for automatic hydraulic lockouts).

STEERING – Front – Power assist hydraulic; controlled by steering wheel. Rear – Full hydraulic; tiller bar control. Independent front and rear steering control allows operator to choose mode of travel for optimum "on-the-move" maneuverability. Four steering modes available are: independent front wheel steer, independent rear wheel steer, 4-wheel coordinated steer and 4-wheel crab steer. *(Electric emergency steering system).

SERVICE BRAKES – Dual braking system, air over hydraulic actuation on all 4 wheels. Size: 17¼ in. x 4 in. (438mm x 102mm). Total lining area 276 sq. in. (1781cm²). *Air dryer prevents moisture in the system for maximum braking efficiency.

PARKING BRAKE – Spring applied, air released cab-controlled parking brake mounted on front axle.

TIRES – 16:00 x 25 – (20 P.R.) Earthmover type, tubeless.
*14:00 x 24 – (20 P.R.) Tube-type, non-directional.
*20.5 x 25 – (20 P.R.) Earthmover type, tubeless.

***TOW WINCH** – Braden PD-15 cab-controlled, front mounted (less rope and hook). Single line pull – 15,000 lbs. (6804kg); single line speed – 58.9 FPM (17.9m/min). Drum capacity of 340 ft. (103.6m) of ⅝ in. (16mm) dia. rope. Controlled by rear steer lever via selector switch.

HYDRAULIC SYSTEM:

RESERVOIR – 88 gallon (333 liters) capacity, all steel fabrication with internal baffles, clean-out access, exterior sight level gauge, breather cap. Strap mounted to frame to reduce high stress levels at corner welds.

FILTER – Tank mounted, return line replaceable cartridge with bypass protection and filter bypass indicator. 25 micron rating.

PUMPS – 3 main gear pumps. 112.5 GPM (425.8 LPM) combined capacity. Separate power steering pump 18.7 GPM (71 LPM). *(Pump disconnect lever with engine jogging switch to facilitate engagement of hydraulic pumps. Jogging switch located on turntable convenient to disconnect lever.)

CONTROL VALVES – Precision four-way double-acting with integral load holding, main and circuit relief valves. Three individual valve banks permitting simultaneous independent control of three crane functions. Maximum operating pressure of 2500 PSI (175.8kg/cm²).

***OIL COOLER** – Full flow, fin and tube, oil to air.

POWER DISTRIBUTION – Main hoist – 39.5 GPM (149.5 LPM) @ 2250 PSI (158.1kg/cm²); Main hoist boost, *Auxiliary hoist, lift, telescope – 46.5 GPM (176 LPM) @ 2500 PSI (175.8kg/cm²); Rear steer, swing, outriggers – 26.5 GPM (100.3 LPM) @ 2250 PSI (158.1kg/cm²).

MISCELLANEOUS STANDARD EQUIPMENT – Air cleaner service restriction indicator, front and rear mounted lifting lugs, front storage well, console light, hourmeter, hydraulic test panel.

***MISCELLANEOUS OPTIONAL EQUIPMENT** – Fenders, 360° rotating beacon, pintle hooks, tire inflation kit, backup alarm, hoist drum cable followers, hookblock tie down loop.

**Denotes optional equipment*

AXLE WEIGHT DISTRIBUTION CHART

ITEM	POUNDS			KILOGRAMS		
	GROSS	FRONT	REAR	GROSS	FRONT	REAR
Basic standard machine to include: 25 ft. - 60 ft. (7.5m - 18.2m) 3-section Trapezoidal-shaped boom, Grove Model 15H-16B main hoist w/450 ft. (137m) of rope, 16:00x25 tires, •5,900 lb. (2676kg) counterweight, GM4-53N diesel engine, 4x4 drive.	44,871	21,575	23,296	20 353	9786	10 567
ADD:						
20 ft. (6.1m) jib for 24 ft. - 42 ft. (7.4m - 12.7m) and 25 ft. - 60 ft. (7.5m - 18.2m) booms	+668	+1106	-438	+303	+502	-199
23 ft. (7.1m) jib for 28 ft. - 70 ft. (8.6m - 21.2m) boom	+952	+1732	-780	+432	+786	-354
23 ft. - 38 ft. (7.1m - 11.6m) jib for 28 ft. - 70 ft. (8.6m - 21.2m) boom	+1685	+2967	-1282	+764	+1346	-582
Fenders (14:00 or 16:00 tires)	+424	+204	+220	+192	+92	+100
Fenders (20.5 tires)	+462	+222	+240	+210	+101	+109
22 ton (20mt) 3 sheave hook block	+325	+954	-629	+147	+433	-285
12 ton (11mt) 1 sheave hook block	+285	+846	-561	+129	+384	-255
5 ton (4.5mt) headache ball	+150	+452	-302	+68	+205	-137
Auxiliary boom nose	+100	+309	-209	+45	+140	-95
Kruger load moment and anti-two block system	+376	+337	+39	+171	+153	+18
••Grove 15S-11B auxiliary hoist w/350 ft. (106.7m) of ½ in. (13mm) dia. rope [use w/24 ft. - 42 ft. (7.4m - 12.7m) and 25 ft. - 60 ft. (7.5m - 18.2m) booms]	-992	-749	-173	-418	-339	-79
••Gearmatic Model 25 auxiliary hoist w/350 ft. (106.7m) of ½ in. (13mm) dia. rope [use w/24 ft. - 42 ft. (7.4m - 12.7m) and 25 ft. - 60 ft. (7.5m - 18.2m) booms]	-610	-860	+250	-277	-390	+113
•Grove Model 15S-11B auxiliary hoist w/350 ft. (106.7m) of ½ in. (13mm) dia. rope [use w/28 ft. - 70 ft. (8.6m - 21.2m) boom]	+839	-297	+1136	+381	-135	+516
•Gearmatic Model 25 auxiliary hoist w/350 ft. (106.7m) of ½ in. (13mm) dia. rope [use w/28 ft. - 70 ft. (8.6m - 21.2m) boom]	+1151	-408	+1559	+522	-185	+707
SUBSTITUTE:						
24 ft. - 42 ft. (7.3m - 12.8m) 2-section Trapezoidal-shaped boom	-2000	-2799	+799	-907	-1270	+363
28 ft. - 70 ft. (8.6m - 21.2m) 3-section Trapezoidal-shaped boom	+1844	+1802	+42	+836	+817	+19
4x2 drive	-165	-	-165	-75	-	-75
Cummins V-378-C145 diesel engine	+171	+95	+76	+78	+43	+35
Caterpillar 3208 diesel engine	+539	+35	+504	+245	+16	+229
Deutz F6L912 diesel engine	-220	-10	-210	-100	-5	-95
14:00x24 tires	-1040	-520	-520	-472	-236	-236
20.5x25 tires	+1008	+504	+504	+458	+229	+229
Grove 15H-11B main hoist w/450 ft. (137m) of ½ in. (13mm) dia. rope	-203	+32	-235	-92	+15	-107
Gearmatic Model 25 main hoist w/450 ft. (137m) of ½ in. (13mm) dia. rope	+312	-49	+361	+142	-22	+164

- 5,900 lb. (2676kg) cwgt. use on 42 ft. boom w/o aux. hoist.
- 4140 lb. (1551kg) cwgt. used only on 42 ft. boom with aux. hoist.
- 6620 lb. (3003kg) cwgt. used on 60 ft. boom w/o aux. hoist and 70 ft. boom with or w/o aux. hoist.
- 6020 lb. (2731 kg) cwgt. used only on 60 ft. boom with aux. hoist.

SPEED AND GRADEABILITY

Forward Drive	Transmission Range	Gear Shift	Maximum Speed		Gradeability @ Stall (%)	Tractive Effort at Stall	
			MPH	KM/H		LBS.	KG
4 Wheel Drive	Low	1st	2.4	3.9	98.8	37,852	17,170
4 Wheel Drive	Low	2nd	5.5	8.9	31.0	16,562	7,513
4 Wheel Drive	Low	3rd	15.2	24.5	8.6	5,532	2,509
2 Wheel Drive	High	1st	5.4	8.7	31.7	16,877	7,655
2 Wheel Drive	High	2nd	11.7	18.8	12.2	7,388	3,351
2 Wheel Drive	High	3rd	24.1	38.8	2.7	2,451	1,112

NOTE: All performance data is based on 48,000 lb. (21 772kg) machine with 16:00 x 25 tires, 4 x 4 drive and GM4-53N engine and may vary plus or minus 10% due to variations in engine performance.
Machines should be operated within the limits of engine crankcase design (30° - Cat, 20° - GM & Deutz, 40° - Cummins). Values for 4 x 4 and 4 x 2 drives for high and low ranges are identical. Gradeability values above 45% (4 x 4 drive) and above 27% (4 x 2 drive) are theoretical.

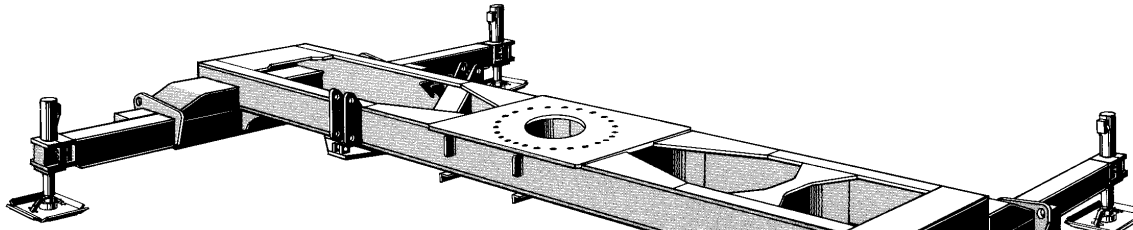

A FRAME FOR ROUGH-TERRAIN

Double parallel box-beam construction with boxed cross-members and full length longitudinals, welded as a single unit and reinforced at critical points to resist torsional stresses and provide a strong, rigid mounting for the turntable. After assembly, the bearing mounting-surface is precision machined to assure 100% metal-to-metal contact for the swing bearing. Outrigger boxes are integral with the frame to provide additional strength and stability.

WIDE OUTRIGGER STANCE . . . GREAT STABILITY

Telescoping beam and jack outriggers have a spread of 17 ft. (5.2m) which provides a nearly square stance for outstanding stability throughout the 360° lifting range. Jacks have a vertical stroke of 21 in. (533mm) and are equipped with integral holding valves. The exclusive Grove Spin-lock†, which permits the jack to be locked mechanically in any position, is available as optional equipment.

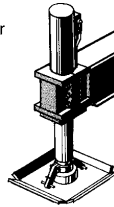

EASY MANEUVERABILITY

Full-power hydraulic steering with four steering modes permits 4-wheel coordinated, 4-wheel crabbing, 2-wheel (front or rear) steering for easier maneuvering in tight quarters. Grove's system of independent control for each axle permits a greater degree of maneuverability with greater ease for the operator.

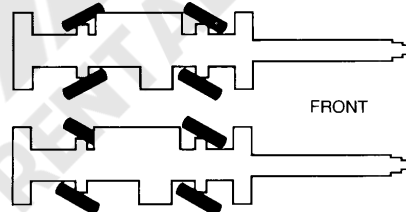
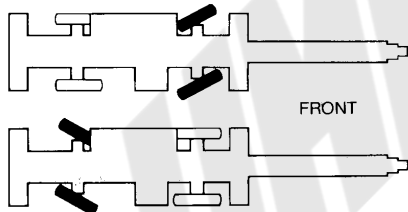
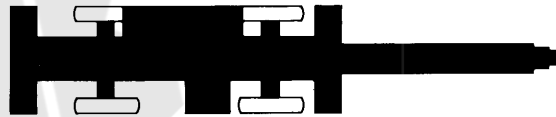

SALE & SERVICE