

Grove GMK5275

Product Guide

Features

- 220 t (275 Ust) capacity
- 13,3 m - 68 m (44 ft - 223 ft) seven-section full-power MEGAFORM™ boom with TWIN-LOCK™ pinning
- 12 m - 21 m (39 ft - 69 ft) hydraulic offset bi-fold swingaway and 2 x 8 m (26 ft) intermediate lattice inserts
- Mercedes-Benz OM502LA, six cylinder, 405 kW (543 HP) at 1800 rpm, max torque 2600 Nm (1918 ft/lb) at 1300 rpm (Tier 4i)

*Alternate engine: Mercedes-Benz OM502LA, eight cylinder, 420 kW (563 HP) at 1800 rpm, max torque 2700 Nm (1991 ft/lb) at 1200 rpm (Tier 3)
- MEGATRAK™ independent hydro-pneumatic suspension
- Allison transmission



Features

MEGATRAK™

The MEGATRAK™ suspension system is the best off road driveline available on the market today. The system's versatility and performance allows the GMK5275 to operate as a true all-terrain crane. The MEGATRAK™ independent suspension and all-wheel steer system allows wheels to remain on the ground at all times so stresses and weight are not continually transferred between axles. MEGATRAK™ provides true ground clearance where others just raise the chassis.

Other benefits of the MEGATRAK™ system are:

- A reliable suspension system
- Excellent job site maneuverability with all-wheel steering
- Commonality among almost all models
- A driveline that remains aligned at all times
- A steering linkage system that is protected against damage
- Constant tire contact for equal tire wear
- Reduced maintenance



TWIN-LOCK™

Boom pinning mechanism automatically pins the sections in position using two horizontal pins.



CraneSTAR

CraneSTAR is an exclusive and innovative crane asset management system that helps improve your profitability and reduce costs by remotely monitoring critical crane data. Visit www.cranestar.com for more information.

ECOS

Electronic Crane Operating System - ECOS enables control of the entire crane's principle operations. Simple programming eases lift planning and a supply of essential information allows full concentration on the lift itself.



EKS 5

The EKS 5 monitors the lifting conditions of the crane at all times and provides a full graphic display, rear lighting, graphic of boom telescoping percentage, and load charts.



Contents

Specifications	4
Dimensions / weights (Tier 3)	7
Dimensions / weights (Tier 4i)	9
Counterweight	11
Working range (main boom)	12
Load charts (main boom)	13
Working range (swingaway)	16
Load charts (hydraulically offsettable swingaway)	17
Working range (heavy duty jib)	20
Load charts (heavy duty jib)	21
Symbols glossary	23

Specifications

Superstructure



Boom

13,3 m - 68 m (44 ft - 223 ft) seven-section, full power MEGAFORM™ boom with TWIN-LOCK™ Pinning.

Maximum tip height: 71 m (233 ft).



Boom nose

Eight nylatron sheaves, mounted on heavy duty tapered roller bearings with removable pin-type rope guards. Quick reeve boom nose. Removable auxiliary boom nose with removable pin type rope guard.



Boom elevation

Single lift cylinder with safety valve provides boom angle from -1.5° to +83°.



*Hydraulic offsettable lattice extension

12 m - 21 m (39 ft - 69 ft) bi-fold lattice swingaway extension, hydraulically offsettable and luffing under load, 5° - 40°. Maximum tip height: 92 m (302 ft)



*Lattice inserts

2 x 8 m (26 ft) inserts for use with lattice swingaway extension to increase length to 29 m (95 ft) or 37 m (121 ft) Maximum tip height: 108 m (354 ft)



Load moment and anti-two block system

Load moment and anti-two block system with audio/visual warning and control lever lockout provides electronic display of boom angle, length, radius, tip height, relative load moment, maximum permissible load, load indication and warning of impending two-block condition.



Cab

All aluminum constructed cab with acoustical lining, hydraulic tilted to 20°. Includes tinted safety glass, adjustable operator's seat, opening windows at side and rear, hinged windshield with wiper, sun visor and window shade. Other features include hot water heater/defroster, armrest integrated crane controls and ergonomically arranged instrumentation.



Swing

3 planetary gear boxes with fixed displacement axial piston motors. Infinitely variable to 1.3 rpm. Free swing or hydrostatically engaged brake controlled by swing lever. Swing brake selected by foot operated switch.



Counterweight

77 t (169,700 lb) consisting of various sections with hydraulic installation/removal system controlled from the superstructure cab.



Engine

Mercedes-Benz OM924LA, diesel, 4-cylinders, water cooled, turbocharged 150 kW (201 HP) at 2200 rpm (80/1269 EWG - fan rigid). Max torque: 800 Nm (590 ft lb) at 1200 rpm. Fuel tank capacity: integrated in carrier fuel reservoir.

Engine transmission: Tier 4i / EPA / CARB (non-road).

**Mercedes-Benz OM 906LA, diesel, 6-cylinders, water cooled, turbocharged, 170 kW (228 HP) at 2200 rpm (80/1269 EWG - fan rigid). Max. torque: 810 Nm (597 ft lb) at 1200 rpm. Fuel tank capacity: integrated in carrier fuel reservoir

Enging emission: Tier 3 / EPA / CARB (non-road).



Electrical system

3 phase alternator: 28V/80A

2 batteries: 12V/170Ah



Hydraulic system

Three separate circuits, two axial piston variable displacement pumps with electronic power limiting control and one axial piston variable displacement pump for slewing. Thermostatically controlled oil cooler. Tank capacity: 870 L (230 gal).

**Two seperate circuits, one axial piston variable displacement pump (load sensing), with electronic power limiting control and one double gear pump for slewing. Thermostatically controlled oil cooler. Tank capacity 916 L (242 gal).

Specifications



Hoist

Main and auxiliary hoist are powered by axial piston motor with planetary gear and brake. "Thumb-thumper" hoist drum rotation indicator alerts operator of hoist movement.

	Main	Auxiliary
Rope length:	290 m (951 ft)	290 m (951 ft)
Rope diameter:	22 mm	22 mm
Line speed:	125 m/min (410 fpm)	125 m/min (410 fpm)
Line pull:	93.5 kN (21,020 lb)	93.5 kN (21,020 lb)

*Optional hookblocks

Lifting capacity	Sheaves	Weight	Parts of line	Possible load with the crane
200 t (220 USt)	9	2400 kg (5291 lb)	2-16	160 t/170 t* (176 USt/187 USt*)
160 t (176 USt)	7	1750 kg (3858 lb)	2-15	135 t (182 USt)
125 t (138 USt)	5	1650 kg (3638 lb)	2-11	100 t (110 USt)
80 t (88 USt)	3	950 kg (2094 lb)	1-7	65 t (72 USt)
32 t** (35 USt)	1	600 kg (1323 lb)	1-3	28 t (31 USt)
12 t*** (13.2 USt)	H/B	300 kg (661 lb)	1	9,5 t (10.5 USt)

* Requires additional boom nose sheave

** Required for overhaul of single part line with boom/jib lengths in excess of 64 m (210 ft)

*** Overhaul weight designed for a maximum of 64 m (210 ft) boom/jib lengths

*Optional equipment

- ▶ Work lights, mounted on boom base section
- ▶ Boom mounted aircraft warning light
- ▶ Radio/CD player for superstructure cab
- ▶ Stainless steel exhaust system with spark arrestor
- ▶ Air conditioning
- ▶ Hook blocks/headache ball
- ▶ Engine independent diesel cab heater, with engine pre-heater. Includes 24 hour timer.
- ▶ Additional cab mounted work light

- ▶ Strobe light
- ▶ Working range limiter
- ▶ Data logger
- ▶ 360° NYC swing lock
- ▶ 2,0 m (6.6 ft) side stowed heavy duty jib with 19 t (41,900 lb) maximum capacity using two parts of line, offset 0° and 25°
- ▶ 2,3 m (7.5 ft) side stowed heavy duty jib with 38 t (83,000 lb) maximum capacity using four parts of line, offset 8° and 30°
- ▶ EKS5 Light semi-graphic display in lieu of standard EKS5

Carrier



Chassis

Box type, torsion resistant frame is fabricated from high strength steel.



Outrigger system

Four hydraulic two stage outrigger beams with vertical cylinders and outrigger pads, 600 mm (23.6 in) square. Outrigger can be set in 5 positions:

Full:	8,1 m (26.6 ft)
Partial:	6,8 m (22.4 ft)
Partial:	5,6 m (18.4 ft)
Partial:	4,4 m (14.4 ft)
Retracted:	2,7 m (9.0 ft)

Independent horizontal and vertical movement controlled from each side of carrier and the superstructure cab. Electronic crane level indicators. Hydraulic disconnect for all outrigger beams. Includes outrigger monitoring system.



Transmission

Allison automatic 4500 SP; 6 forward and 1 reverse speed. Two stage transfer case with inter-axle differential lock.

**Allison automatic 4000 SP; 6 forward and 1 reverse speed. Two stage transfer case with inter-axle differential lock.



Drive/steer

10x6x10 (3, 4 and 5 driven)



Suspension

Grove exclusive MEGATRAK™ suspension. Independent hydro-pneumatic system acting on all wheels with hydraulic lockout. Suspension can be raised 160 mm (6.3 in) or lowered 120 mm (4.7 in), both longitudinally and transversely. Features an automatic leveling system for highway travel.

Specifications



Axles

1st axle line – steer
2nd axle line – steer (optional drive)
3rd axle line – drive/steer (permanent drive with 10x6, disconnects for highway with 10x8)
4th axle line – drive/steer (connects for all wheel steer)
5th axle line – drive/steer
Drive axles with planetary hub reduction and center mounted gearing. Standard inter-axle and cross axle differential locks.



Tires

10 tires, 445/95 R25 (16.00 R25) (vehicle width – 3,0 m [9.8 ft])



Steering

Dual circuit, hydraulic power assisted steering system. Transfer case mounted, ground driven emergency steering pump. Axles 1, 2, 3 and 5 steer on highway. Separate steering (steer by wire) of the 4th and 5th axles for all wheel and crab steering, controlled by an electronic rocker switch.



Engine

Mercedes-Benz OM 502LA, diesel, 8-cylinders, water cooled, turbocharged, 405 kW (543 HP) at 1800 rpm (80/1269 fan loose). Max. torque: 2600 Nm (1918 ft lb) at 1300 rpm. Fuel tank capacity: 515 L (136 gal).

Engine emission: Tier 4i / EPA / CARB (non-road).

**Mercedes-Benz OM502LA, diesel, 8-cylinders, water cooled, turbocharged, 420 kW (563 HP) at 1800 rpm (80/1269 EWG fan loose). Max. torque: 2700 Nm (1991 ft lb) at 1200 rpm. Fuel tank capacity 515 L (136 gal).

Engine emission: Tier 3 / EPA / CARB (non-road).



Brakes

Service brake: pneumatic dual circuit disc brakes acting on all wheels, air dryer.

Permanent brake: exhaust brake and constant throttle brake.

Parking brake: pneumatically operated spring-loaded brake acting on axle lines 2, 3, 4 and 5.

**Service brake: pneumatic dual circuit drum brakes, acting on all wheels, air dryer.

Permanent brake: exhaust brake and constant throttle brake.

Parking brake: pneumatically operated spring-loaded brake acting on axle lines 2, 3, 4 and 5.



Cab

Two-man, aluminum construction with the following features: safety glass, driver seat with pneumatic suspension, engine-dependent hot water heater, power windows, heated rear view mirrors, complete instrumentation and driving controls.



Electrical system

24V system with three phase alternator, 28V/100A

2 batteries, 12V/170 Ah



Maximum speed

85 km/h (53 mph)



Gradeability (theoretical)

50% - 14.00 tires

45% - 16.00 / 20.5 tires

Miscellaneous standard equipment

Work light; tool kit; fire extinguishers; auxiliary boom nose; radio/CD player in carrier cab, heated rear view mirrors, wind speed indicator, CraneSTAR asset management system.

*Optional equipment

- ▶ Stainless steel exhaust system with spark arrestor
- ▶ Air conditioning
- ▶ 385/95 R25 (14.00 R25) (vehicle width 3 m [9.8 ft])
- ▶ 525/80 R25 (20.5 R25) (vehicle width 3,1 m [10.2 ft])
- ▶ 10x8x10 drive/steer (2, 3, 4 and 5 driven)
- ▶ Transmission retarder (in lieu of engine compression brake)
- ▶ Engine independent diesel cab heater, with engine pre-heater. Includes 24 hour timer.
- ▶ Strobe light
- ▶ Work lights for outriggers
- ▶ Spare tire and wheel with carry bracket
- ▶ Rear mounted stowage box
- ▶ Outrigger pad load indicator
- ▶ Trailer hitch
- ▶ Steel outrigger pads

Dimensions

Mercedes-Benz (Tier 4i)

*Drawn with tires 525/80 R25
 All turning radius by normal steering mode (R)
 also all-wheel steering (Ra)

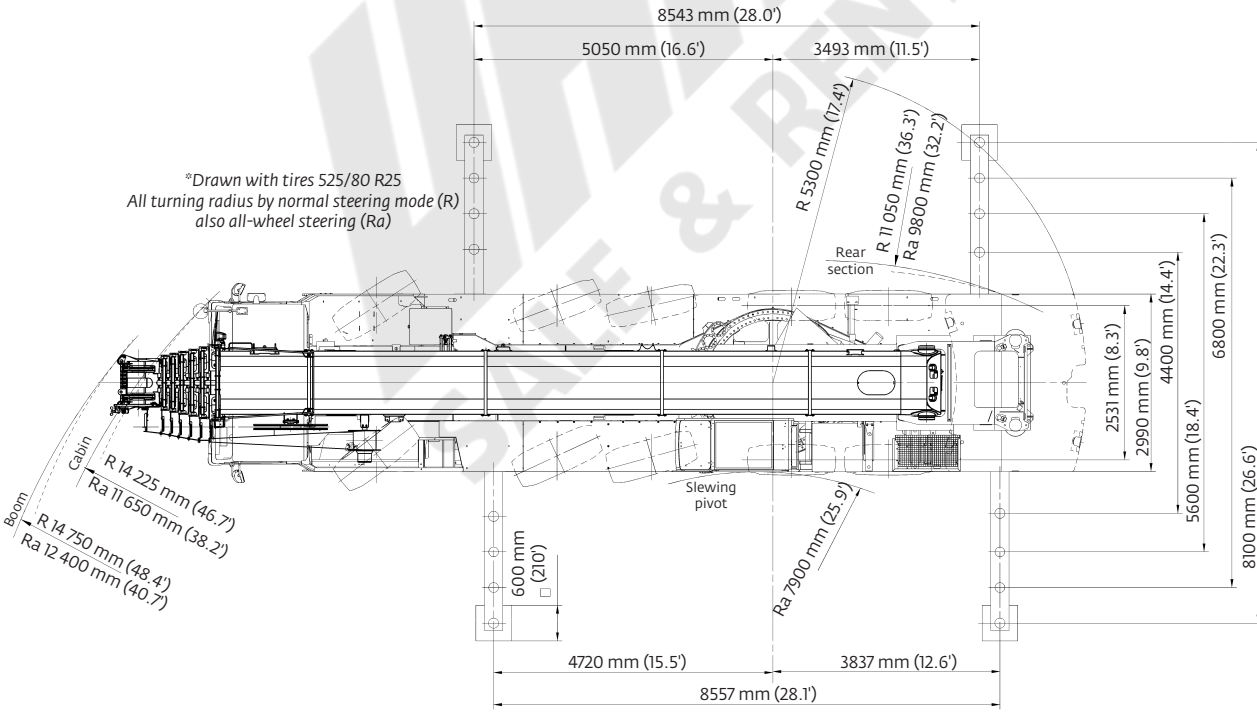
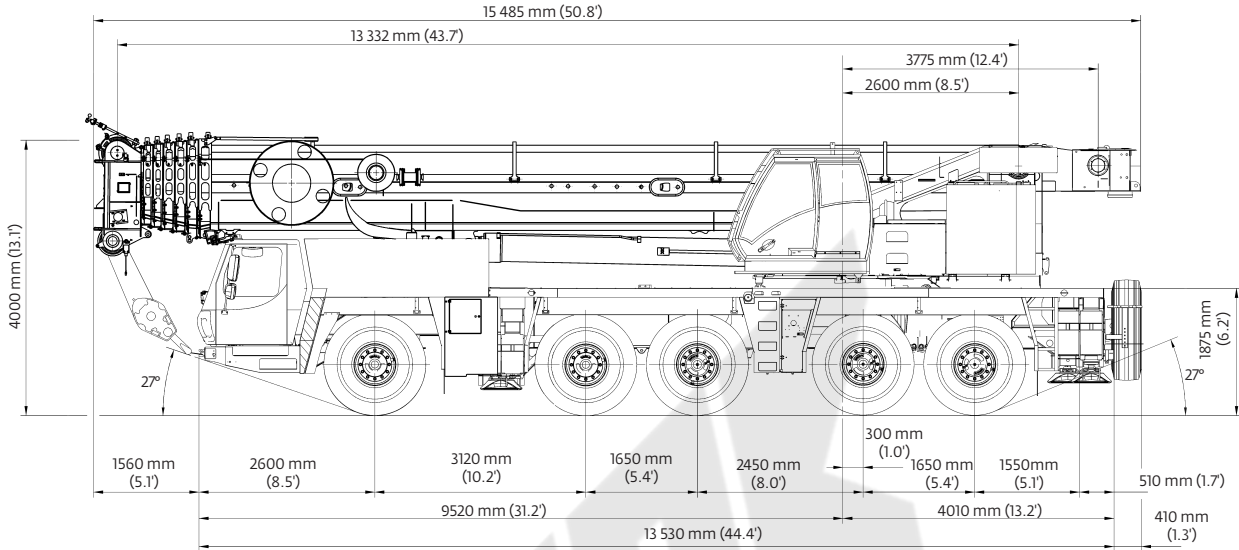

Weights

Mercedes-Benz (Tier 4i)

Trailing boom

Tires	A	B
385/95 (14.00) R25	2690 mm (8.8 ft)	635 mm (2.1 ft)
445/95 (16.00) R25	2740 mm (9.0 ft)	685 mm (2.2 ft)
525/80 (20.5) R25	2740 mm (9.0 ft)	685 mm (2.2 ft)

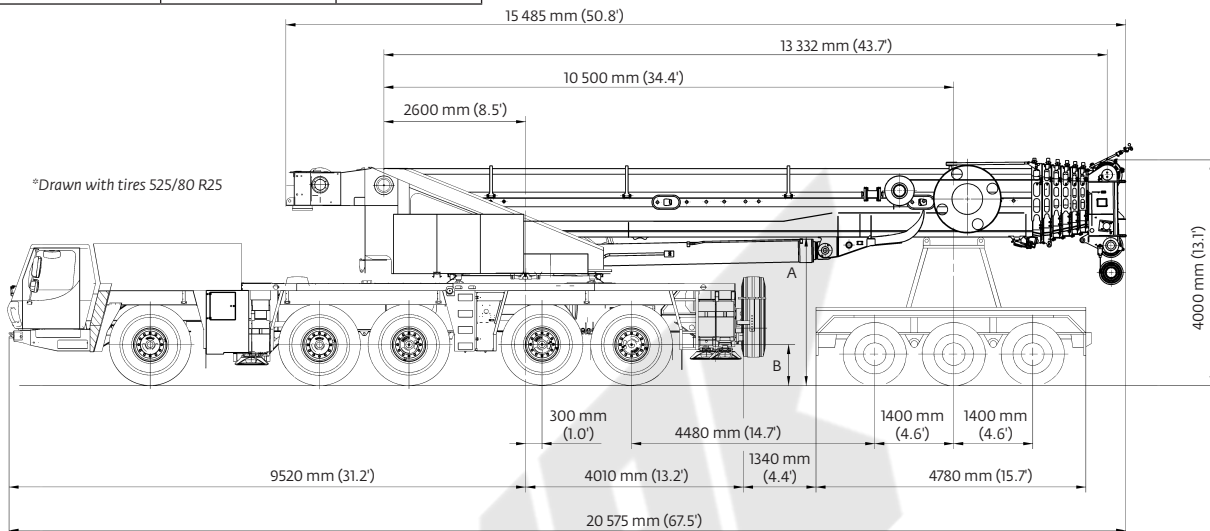

Basic weights - kg (lb)	Axles 1-3		Axles 4 and 5		Dolly		Total	
GMK 5275 Mercedes power Tier 4i with: 20.5R25 tires, 10x8x10 drive/steer, 11 m-18m (36-59 ft) hydraulic luffing swingaway, 2nd oil cooler, outrigger pads, auxiliary hoist, driver and tanks filled, 3 axle boom dolly (4309 kg / 9400 lb)	29 204	(64,382)	20 885	(46,043)	19 362	(42,684)	69 450	(153,103)
Additions:								
5000 kg (11 000 lb) section pinned to superstructure (special counterweight version)	4831	(10,651)	169	(373)	0	(0)	5000	(11,023)
11 000 kg (24,250 lb) base section stowed on carrier	10 629	(23,433)	371	(818)	0	(0)	11 000	(24,251)
Removals:								
Brackets for hydraulic swingaway incl. hose reel	- 8	(-18)	- 4	(-9)	- 257	(-567)	- 270	(-595)
11 m - 18 m (36 ft - 59 ft) hydraulic swingaway	- 345	(-761)	- 176	(-388)	- 1489	(-3283)	- 2010	(-4431)
Front outriggers	- 2190	(-4828)	300	(661)	0	(0)	- 1890	(-4167)
Rear outriggers	1338	(2950)	- 3678	(-8109)	0	(0)	- 2340	(-5159)
Front and rear outrigger floats	- 59	(-130)	- 141	(-311)	0	(0)	- 200	(-441)
Substitutions:								
10x6x10 drive/steer	- 316	(-697)	- 39	(-86)	0	(0)	- 355	(-783)
14.00R25 tires	- 612	(-1349)	- 408	(-899)	0	(0)	- 1020	(-2249)
16.00R25 tires	- 252	(-556)	- 168	(-370)	0	(0)	- 420	(-926)

Boom over front	Axles 1 - 3		Axles 4 and 5		Total	
Basic weights - kg (lb)						
Mercedes power Tier 4i, 16.00R25 tires, 10x6x10 drive/steer, 2nd oil cooler, outrigger pads, driver and tanks filled	37 118	(81,831)	23 189	(51,123)	60 306	(132,952)
Additions:						
10x8x10 drive/steer	316	(697)	39	(86)	355	(783)
Spare wheel 14.00 R25 XGC steel rim with stowage	- 186	(-410)	446	(983)	260	(573)
Spare wheel 16.00 R25 XGC steel rim with stowage	- 229	(-505)	549	(1210)	320	(705)
Spare wheel 20.5 R25 XGC steel rim with stowage	- 259	(-571)	621	(1369)	362	(798)
Brackets for hydraulic swingaway	92	(203)	- 12	(-26)	80	(176)
Hose reel + parts for hydraulic swingaway	339	(747)	- 149	(-328)	190	(419)
11 m - 18 m (36 ft - 59 ft) hydraulic swingaway	2321	(5117)	- 311	(-686)	2010	(4431)
Auxiliary hoist	- 1417	(-3124)	3157	(6960)	1740	(3836)
11 000 kg (24,250 lb) base plate stowed on carrier	10 581	(23,327)	369	(814)	10 950	(24,141)
5000 kg (11,000 lb) slab fixed to turntable (special counterweight version)	- 3452	(-7610)	8432	(18,589)	4980	(10,979)
Substitutions:						
14.00R25 tires	- 360	(-794)	- 240	(-529)	- 600	(-1323)
20.5R25 tires	252	(556)	168	(370)	420	(926)
Removals:						
Boom assembly w/o lift cylinder	- 19 655	(-43,332)	- 1480	(-3263)	- 21 135	(-46,594)
Front outriggers	- 2350	(-5181)	289	(637)	- 2061	(-4544)
Rear outriggers	1093	(2410)	- 3586	(-7906)	- 2493	(-5496)
Front and rear outrigger floats	- 59	(-130)	- 141	(-311)	- 200	(-441)

Counterweight

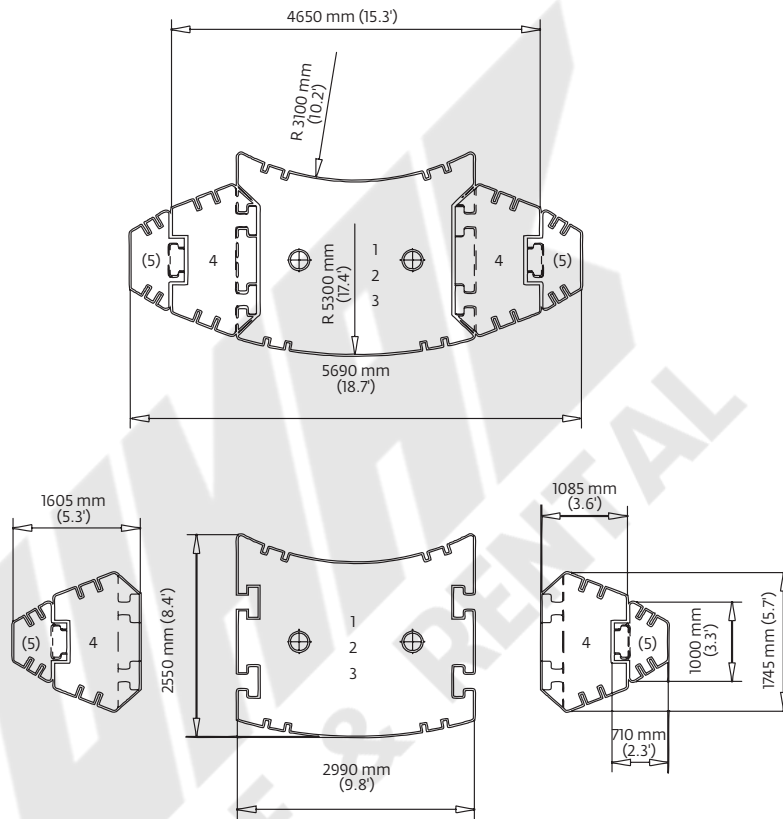
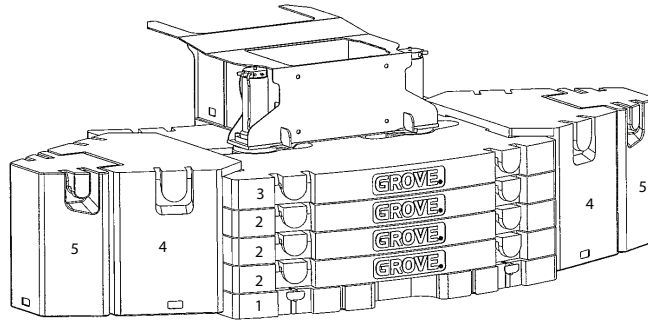

Counterweight Configuration kg (lb)

	1 (Baseplate)	2 (Stackable)	3 (Stackable)	4 (Wing)	5 (Wing)
	11 000 (24,200)	10 000 (22,046)	10 000 (22,046)	10 000 (22,046)	3000 (6600)
11 000 (24,200)	•				
21 000 (46,200)	•	•			
31 000 (68,300)	•	X2			
41 000 (90,300)	•	X3			
51 000 (112,400)	•	X3	•		
71 000 (156,500)	•	X3	•	X2	
77 000 (169,700)	•	X3	•	X2	X2

Working range

44 ft - 223 ft main boom

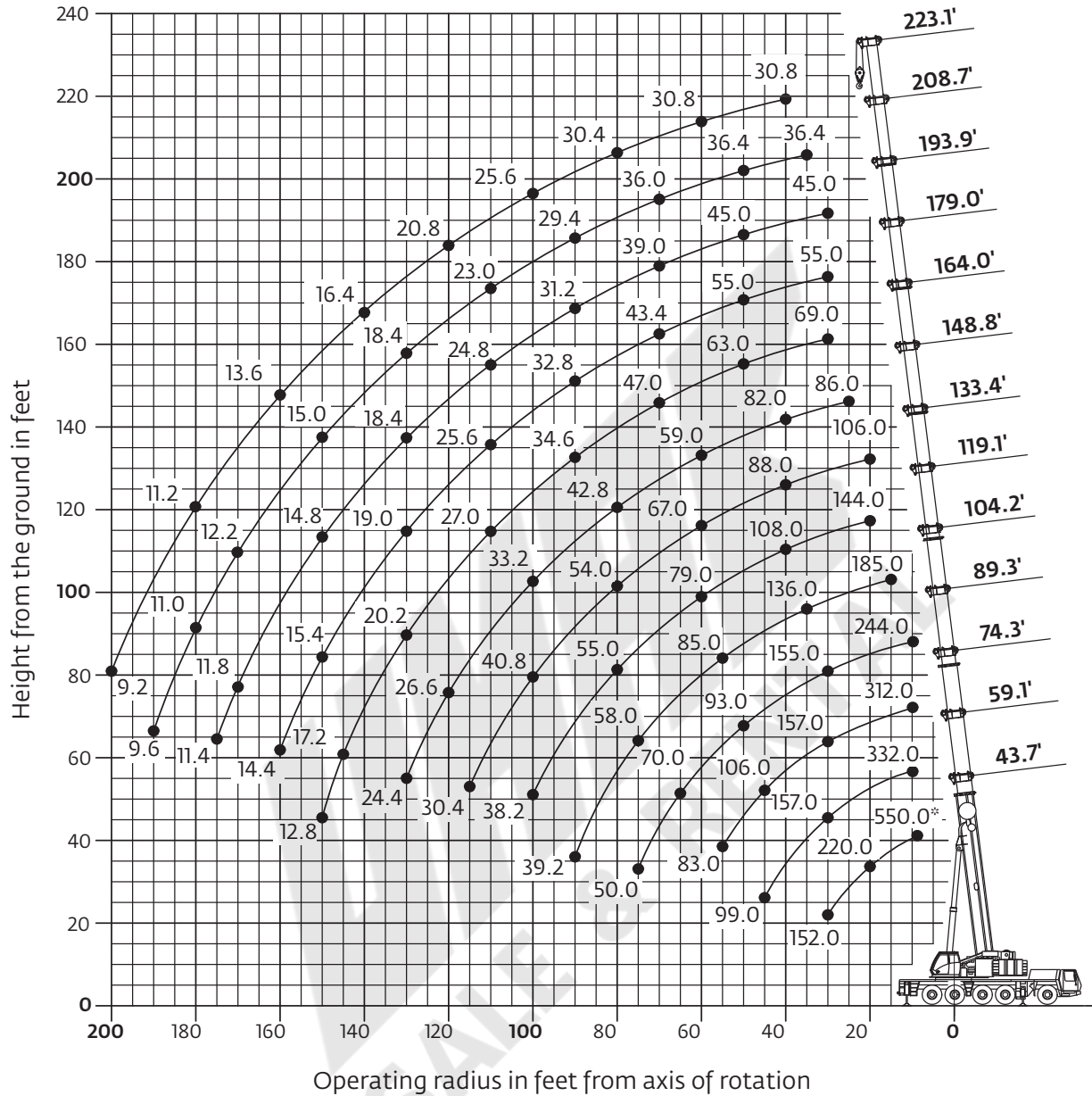

Hook heights shown in the working diagram do not consider loaded boom deflection.





	Hook block	H
	200 ton, 9 sheave	12.0 ft (3650 mm)
	160 ton, 7 sheave	12.0 ft (3650 mm)
	125 ton, 5 sheave	10.8 ft (3300 mm)
	80 ton, 3 sheave	10.8 ft (3300 mm)
	32 ton, 1 sheave	10.5 ft (3200 mm)
	12 ton, single line headache ball	8.0 ft (2450 mm)

THIS CHART IS ONLY A GUIDE AND SHOULD NOT BE USED TO OPERATE THE CRANE.

The individual crane's load chart, operating instructions and other instructional plates must be read and understood prior to operating the crane

Load charts

Main boom







13.3 m - 68 m
 (44 ft - 223 ft)

77 000 kg
 (169,700 lb)

26 ft 7 in spread
 (100%)

360°



 Pounds x 1000

Feet	43.7'	59.1'	74.3'	89.3'	104.2'	119.1'	133.4'	148.8'	164.0'	179.0'	193.9'	208.7'	223.1'
8	*550.0												
10	346.0	332.0	312.0	244.0									
15	272.0	270.0	260.0	242.0	185.0								
20	220.0	222.0	215.0	212.0	182.0	144.0	106.0						
25	184.0	185.0	181.0	181.0	166.0	140.0	106.0	86.0					
30	152.0	157.0	157.0	155.0	151.0	129.0	105.0	86.0	69.0	55.0	45.0		
35		136.0	136.0	135.0	136.0	118.0	96.0	86.0	69.0	55.0	45.0	36.4	
40		121.0	119.0	118.0	120.0	108.0	88.0	82.0	69.0	55.0	45.0	36.4	30.8
45		99.0	106.0	104.0	106.0	99.0	81.0	75.0	68.0	55.0	45.0	36.4	30.8
50			95.0	93.0	95.0	92.0	76.0	70.0	63.0	55.0	45.0	36.4	30.8
55			83.0	84.0	85.0	85.0	72.0	64.0	59.0	52.0	45.0	36.4	30.8
60				76.0	77.0	79.0	67.0	59.0	54.0	49.0	44.0	36.4	30.8
65				70.0	70.0	72.0	63.0	54.0	50.0	46.0	41.2	36.4	30.8
70				63.0	64.0	66.0	60.0	50.0	47.0	43.4	39.0	36.0	30.8
75				50.0	58.0	61.0	57.0	46.0	43.0	40.4	36.8	34.4	30.8
80					53.0	55.0	54.0	42.8	39.6	37.6	34.8	32.6	30.4
85					49.0	51.0	51.0	40.2	37.2	35.2	33.0	31.0	29.2
90					39.2	46.0	48.0	37.6	34.6	32.8	31.2	29.4	28.0
95						42.4	44.0	35.2	32.4	30.8	29.4	28.0	26.8
100						38.2	40.8	33.2	30.4	28.8	27.8	26.4	25.6
105							37.6	31.4	28.8	27.2	26.4	24.8	24.4
110							34.8	29.6	27.0	25.6	24.8	23.0	23.2
115							30.4	28.0	25.2	23.8	23.0	21.4	22.0
120								26.6	23.2	21.8	21.2	20.4	20.8
125								25.2	21.4	20.0	19.4	19.4	19.4
130								24.4	20.2	19.0	18.4	18.4	18.0
135									19.2	18.0	17.4	17.4	17.2
140									18.2	17.0	16.4	16.6	16.4
145									17.2	16.0	15.6	15.8	15.6
150									12.8	15.4	14.8	15.0	15.0
155										14.8	14.0	14.2	14.2
160										14.4	13.2	13.4	13.6
165											12.6	12.8	13.0
170											11.8	12.2	12.4
175											11.4	11.6	11.8
180												11.0	11.2
185												10.6	10.6
190												9.6	10.2
195													9.6
200													9.2

* Over the rear with special equipment

Loads greater than 297,000 lb/335,000 lb can only be lifted with additional/special equipment.

Load charts

Main boom



13,3 m - 68 m
(44 ft - 223 ft)



51 000 kg
(112,400 lb)



26 ft 7 in spread
(100%)



360°



Pounds x 1000

Feet	43.7'	59.1'	74.3'	89.3'	104.2'	119.1'	133.4'	148.8'	164.0'	179.0'	193.9'	208.7'	223.1'
10	336.0	332.0	312.0	244.0									
15	262.0	260.0	258.0	242.0	185.0								
20	210.0	211.0	208.0	210.0	182.0	144.0	106.0						
25	176.0	177.0	176.0	175.0	166.0	140.0	106.0	86.0					
30	149.0	150.0	150.0	148.0	150.0	129.0	105.0	86.0	69.0	55.0	45.0		
35		132.0	130.0	127.0	124.0	118.0	96.0	86.0	69.0	55.0	45.0	36.4	
40		114.0	111.0	110.0	103.0	102.0	88.0	82.0	69.0	55.0	45.0	36.4	30.8
45		98.0	95.0	94.0	90.0	88.0	81.0	75.0	68.0	55.0	45.0	36.4	30.8
50			83.0	82.0	81.0	76.0	76.0	70.0	63.0	55.0	45.0	36.4	30.8
55			72.0	71.0	72.0	67.0	68.0	64.0	59.0	52.0	45.0	36.4	30.8
60				62.0	64.0	62.0	60.0	57.0	54.0	49.0	44.0	36.4	30.8
65				57.0	56.0	58.0	54.0	50.0	49.0	46.0	41.2	36.4	30.8
70				51.0	50.0	52.0	49.0	45.0	43.8	43.2	39.0	36.0	30.8
75				46.0	45.0	47.0	44.0	40.8	39.6	39.0	36.8	34.4	30.8
80					41.6	42.0	40.0	37.0	35.8	35.4	34.8	32.6	30.4
85					39.2	38.2	36.0	34.2	32.4	32.0	32.0	31.0	29.2
90					35.8	34.6	32.6	32.8	29.4	29.2	29.2	29.4	28.0
95						31.4	29.4	31.4	26.8	26.6	26.6	27.4	26.8
100						28.8	26.8	28.6	24.4	24.4	24.4	25.0	25.6
105							25.2	26.0	22.2	22.8	22.2	23.0	23.6
110							24.2	23.8	20.0	21.2	20.4	21.2	21.8
115							23.4	21.8	18.4	20.2	19.0	19.4	20.2
120								20.0	17.8	19.4	18.0	18.6	18.6
125								18.4	17.0	18.4	17.2	17.6	17.2
130								16.8	16.2	17.8	16.4	16.6	15.8
135									15.6	16.8	15.8	15.8	14.6
140									15.0	15.4	15.0	14.8	13.4
145										14.4	14.2	13.6	12.4
150										13.2	13.2	12.6	11.2
155										12.2	12.2	11.4	10.2
160										11.4	11.2	10.6	9.2
165											10.6	9.6	8.4
170											9.8	8.8	7.6
175											9.2	8.0	6.8
180												7.2	6.0
185												6.6	5.2
190												6.0	4.6
195													4.0
200													3.4



13,3 m - 68 m
(44 ft - 223 ft)



41 000 kg
(90,300 lb)



26 ft 7 in spread
(100%)



360°



Pounds x 1000

Feet	43.7'	59.1'	74.3'	89.3'	104.2'	119.1'	133.4'	148.8'	164.0'	179.0'	193.9'	208.7'	223.1'
10	332.0	328.0	312.0	244.0									
15	256.0	256.0	254.0	242.0	185.0								
20	207.0	208.0	206.0	206.0	182.0	144.0	106.0						
25	172.0	173.0	173.0	171.0	166.0	140.0	106.0	86.0					
30	146.0	149.0	146.0	138.0	131.0	128.0	105.0	86.0	69.0	55.0	45.0		
35		124.0	117.0	114.0	110.0	105.0	96.0	86.0	69.0	55.0	45.0	36.4	
40		102.0	101.0	95.0	94.0	88.0	87.0	82.0	69.0	55.0	45.0	36.4	30.8
45		84.0	85.0	81.0	80.0	76.0	75.0	71.0	68.0	55.0	45.0	36.4	30.8
50			72.0	72.0	70.0	70.0	65.0	61.0	59.0	55.0	45.0	36.4	30.8
55			64.0	64.0	61.0	62.0	57.0	54.0	52.0	51.0	45.0	36.4	30.8
60				55.0	56.0	55.0	51.0	47.0	46.0	45.0	44.0	36.4	30.8
65				49.0	51.0	49.0	45.0	42.0	40.6	40.0	39.6	36.4	30.8
70				43.6	45.0	44.0	40.6	39.8	36.2	35.6	35.4	36.0	30.8
75				38.4	40.6	39.4	36.4	37.6	32.4	32.0	31.8	32.4	30.8
80					36.6	35.4	33.0	34.0	29.0	29.4	29.2	30.2	29.8
85					33.0	31.6	30.0	31.0	26.4	28.2	27.8	28.6	27.0
90					29.8	28.6	28.6	28.4	25.0	27.0	26.2	26.6	24.6
95						25.8	27.4	25.6	23.2	25.6	24.6	24.4	22.4
100						23.4	25.2	23.2	21.2	24.0	23.0	22.4	20.4
105							22.8	21.0	20.4	22.2	20.8	20.6	18.6
110							21.0	19.0	19.4	20.4	19.8	18.8	17.0
115							19.2	17.2	18.4	18.6	18.4	17.4	15.6
120								16.0	17.8	17.0	17.0	16.0	14.2
125								15.2	17.0	15.8	16.0	14.6	13.0
130								14.6	15.8	15.0	14.6	13.4	11.8
135									14.6	14.2	13.4	12.2	10.6
140									13.4	13.0	12.2	11.2	9.6
145										12.0	11.2	10.0	8.8
150										11.0	10.2	9.0	7.8
155										10.2	9.2	8.2	7.0
160										9.4	8.4	7.4	6.0
165											7.6	6.6	5.2
170											7.0	5.8	4.6
175											6.2	5.2	3.8
180												4.4	3.2
185													3.8
190													3.2

Load charts

Main boom







13.3 m - 68 m
(44 ft - 223 ft)

21 000 kg
(46,200 lb)

26 ft 7 in spread
(100%)

360°



 Pounds x 1000

Feet	43.7'	59.1'	74.3'	89.3'	104.2'	119.1'	133.4'	148.8'	164.0'	179.0'	193.9'	208.7'	223.1'
10	320.0	318.0	312.0	244.0									
15	248.0	248.0	246.0	242.0	185.0								
20	199.0	200.0	187.0	175.0	158.0	144.0	106.0						
25	154.0	148.0	138.0	128.0	123.0	113.0	106.0	86.0					
30	114.0	111.0	105.0	103.0	96.0	94.0	87.0	81.0	69.0	55.0	45.0		
35		90.0	87.0	83.0	82.0	77.0	71.0	66.0	63.0	55.0	45.0	36.4	
40		72.0	72.0	68.0	68.0	64.0	59.0	59.0	52.0	51.0	45.0	36.4	30.8
45		58.0	60.0	61.0	58.0	54.0	50.0	51.0	43.8	43.0	42.0	36.4	30.8
50			50.0	52.0	50.0	47.0	45.0	43.4	39.2	40.6	39.6	36.0	30.8
55			45.0	46.0	43.2	40.2	41.2	37.4	36.8	37.4	36.6	34.0	30.8
60				39.2	37.8	36.0	36.0	32.6	34.6	34.0	32.2	29.8	27.4
65				33.8	33.2	33.8	31.8	30.6	31.4	30.2	28.4	26.2	24.0
70				29.4	29.0	30.6	28.2	29.0	28.4	26.8	25.2	23.2	21.0
75				22.8	25.4	27.4	25.0	27.0	25.4	24.0	22.4	20.4	18.4
80					22.2	24.2	23.2	24.4	23.0	21.4	20.0	18.2	16.2
85					22.0	21.4	20.8	22.0	20.6	19.2	17.8	16.0	14.2
90					19.6	19.0	19.4	20.0	18.6	17.2	16.0	14.2	12.4
95						17.4	18.4	18.0	16.8	15.6	14.2	12.6	10.8
100						16.6	16.4	16.2	15.2	14.0	12.6	11.0	9.2
105							14.8	14.6	13.8	12.6	11.2	9.8	8.0
110							13.4	13.0	12.4	11.2	10.0	8.4	6.8
115							12.0	11.6	11.0	10.0	8.8	7.4	5.6
120								10.4	9.8	9.0	7.8	6.4	4.6
125								9.4	8.6	8.0	6.8	5.4	3.8
130								8.4	7.6	7.0	6.0	4.6	2.8
135									6.8	6.0	5.2	3.8	
140									6.0	5.2	4.4	3.0	
145										4.4	3.6		
150										3.6	2.8		
155										3.0			





13.3 m - 68 m
(44 ft - 223 ft)

0 kg
(0 lb)

26 ft 7 in spread
(100%)

360°



 Pounds x 1000

Feet	43.7'	59.1'	74.3'	89.3'	104.2'	119.1'	133.4'	148.8'	164.0'	177.6'	192.6'
10	308.0	308.0	286.0	232.0							
15	222.0	185.0	160.0	144.0	125.0						
20	122.0	114.0	105.0	100.0	90.0	79.0	76.0				
25	81.0	80.0	77.0	72.0	65.0	63.0	57.0	56.0			
30	56.0	58.0	57.0	54.0	53.0	49.0	48.0	45.0	41.2	37.6	34.4
35		44.0	44.0	44.0	42.4	41.2	38.8	36.4	33.4	30.6	28.0
40		34.2	35.6	36.0	35.0	33.8	32.0	30.0	27.6	25.2	22.8
45			28.8	29.6	29.0	28.0	26.6	25.0	23.0	20.8	18.8
50			23.8	24.8	24.2	23.6	22.4	21.0	19.2	17.2	15.4
55			19.8	20.8	20.4	20.0	19.0	17.8	16.2	14.4	12.8
60				17.6	17.4	17.0	16.2	15.0	13.6	12.0	10.4
65				15.0	14.8	14.6	13.8	12.8	11.4	9.8	8.4
70				12.6	12.6	12.4	11.8	10.8	9.4	8.0	6.8
75				5.8	10.8	10.6	10.0	9.2	7.8	6.6	5.2
80					9.2	9.0	8.4	7.6	6.4	5.2	4.0
85					7.6	7.8	7.2	6.4	5.2	4.0	2.8
90					6.2	6.6	6.0	5.2	4.0	2.8	
95						5.4	4.8	4.2	3.0		
100						4.4	4.0	3.2			
105							3.2				

Working range

223 ft main boom with 39 ft and 69 ft swingaway

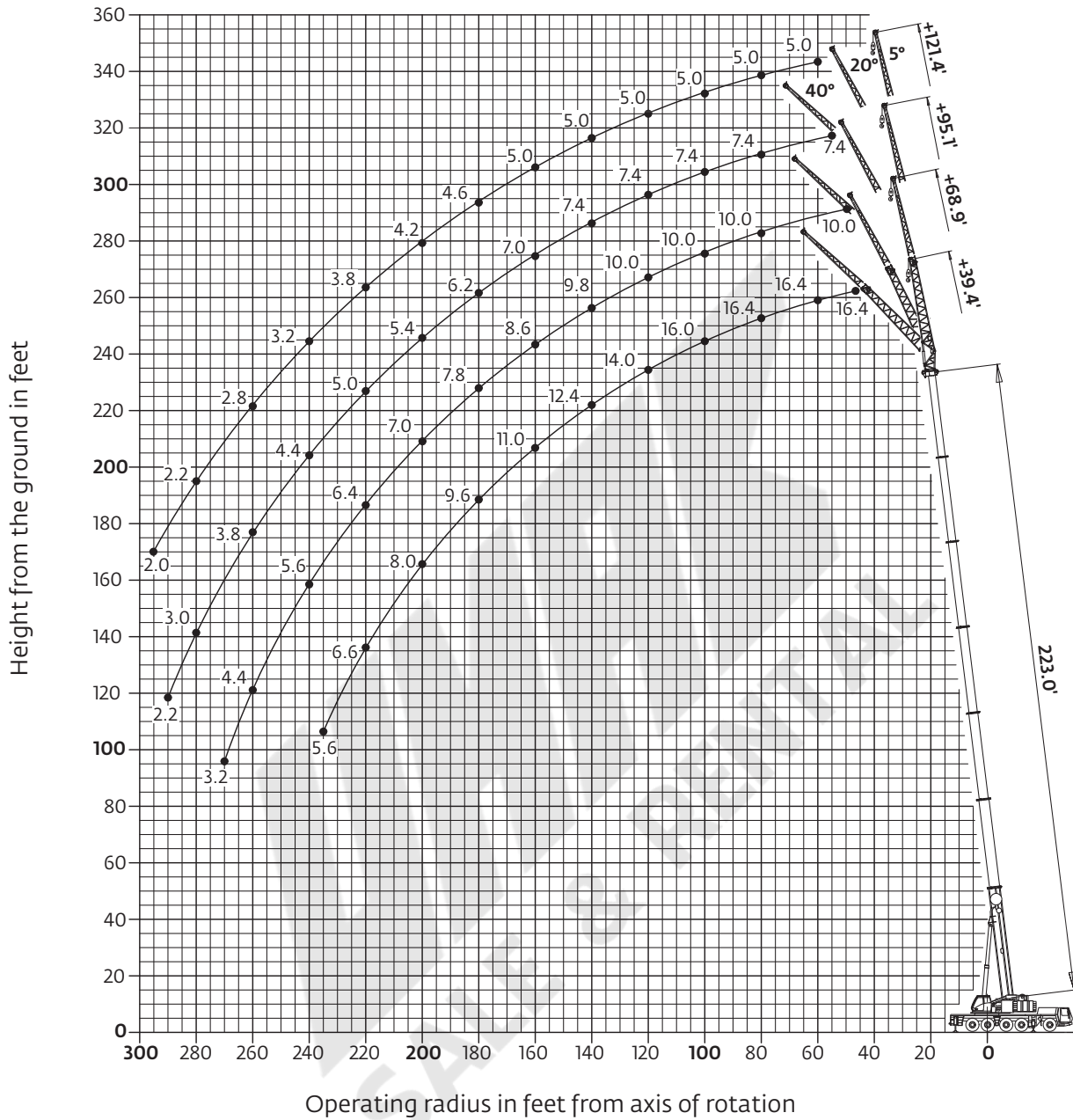

Hook heights shown in the working diagram do not consider loaded boom deflection.

THIS CHART IS ONLY A GUIDE AND SHOULD NOT BE USED TO OPERATE THE CRANE.

The individual crane's load chart, operating instructions and other instructional plates must be read and understood prior to operating the crane.

Load charts

Hydraulic offsettable swingaway

Intermediate angle and loads for luffing



68 m
(223 ft)



12-21-29-37 m
(39-69-95-121 ft)



77 000 kg
(169,700 lb)



26 ft 7 in spread
(100%)



360°



Pounds x 1000

Radius	223' + 39.4'			223' + 68.9'			223' + 95.1'			223' + 121.4'		
	5°	5° - 20°	20° - 40°	5°	5° - 20°	20° - 40°	5°	5° - 20°	20° - 40°	5°	5° - 20°	20° - 40°
	X 1000 lb											
45	16.4											
50	16.4	16.4		10.0								
55	16.4	16.4		10.0			7.4					
60	16.4	16.4	16.4	10.0			7.4			5.0		
65	16.4	16.4	16.4	10.0			7.4			5.0		
70	16.4	16.4	16.4	10.0	10.0		7.4			5.0		
75	16.4	16.4	16.4	10.0	10.0		7.4	7.4		5.0		
80	16.4	16.4	16.4	10.0	10.0		7.4	7.4		5.0	5.0	
85	16.4	16.4	16.0	10.0	10.0		7.4	7.4		5.0	5.0	
90	16.4	16.2	15.6	10.0	10.0	9.4	7.4	7.4		5.0	5.0	
95	16.4	15.8	15.2	10.0	10.0	9.4	7.4	7.4	7.2	5.0	5.0	4.0
100	16.0	15.2	14.8	10.0	10.0	9.2	7.4	7.4	7.2	5.0	5.0	4.0
105	15.6	14.8	14.4	10.0	10.0	9.2	7.4	7.4	7.2	5.0	5.0	4.0
110	15.0	14.4	14.0	10.0	10.0	9.2	7.4	7.4	7.2	5.0	5.0	4.0
115	14.4	13.8	13.6	10.0	10.0	9.0	7.4	7.4	7.2	5.0	5.0	4.0
120	14.0	13.4	13.2	10.0	10.0	9.0	7.4	7.4	7.2	5.0	5.0	4.0
125	13.6	13.0	12.8	10.0	10.0	9.0	7.4	7.4	7.2	5.0	5.0	4.0
130	13.2	12.6	12.4	10.0	9.8	8.8	7.4	7.4	7.2	5.0	5.0	4.0
135	12.8	12.2	12.2	10.0	9.6	8.8	7.4	7.4	7.2	5.0	5.0	4.0
140	12.4	12.0	11.8	9.8	9.4	8.8	7.4	7.2	7.0	5.0	5.0	4.0
145	12.0	11.6	11.4	9.4	9.0	8.6	7.4	7.2	7.0	5.0	5.0	4.0
150	11.6	11.2	11.2	9.2	8.8	8.6	7.4	7.0	6.8	5.0	4.8	4.0
155	11.2	11.0	11.0	9.0	8.6	8.4	7.2	6.8	6.6	5.0	4.8	4.0
160	11.0	10.6	10.6	8.6	8.4	8.2	7.0	6.6	6.6	5.0	4.8	4.0
165	10.6	10.4	10.4	8.4	8.2	8.0	6.8	6.6	6.4	4.8	4.8	4.0
170	10.2	10.2	10.2	8.2	8.0	8.0	6.6	6.4	6.2	4.8	4.6	4.0
175	9.8	9.8	10.0	8.0	7.8	7.8	6.4	6.2	6.2	4.8	4.6	4.0
180	9.6	9.6	9.6	7.8	7.6	7.6	6.2	6.0	6.0	4.6	4.6	4.0
185	9.2	9.2	9.4	7.6	7.4	7.4	6.0	5.8	5.8	4.6	4.4	4.0
190	8.8	8.8	9.0	7.4	7.2	7.2	5.8	5.6	5.8	4.4	4.4	4.0
195	8.2	8.4	8.6	7.2	7.0	7.0	5.6	5.6	5.6	4.2	4.2	4.0
200	8.0	8.0		7.0	6.8	6.8	5.4	5.4	5.4	4.2	4.0	4.0
205	7.6	7.8		6.8	6.6	6.8	5.2	5.2	5.4	4.0	4.0	4.0
210	7.2	7.4		6.6	6.4	6.6	5.0	5.0	5.2	3.8	3.8	4.0
215	6.8	7.0		6.4	6.4	6.4	5.0	5.0	5.0	3.6	3.8	3.8
220	6.4	6.6		6.2	6.2	6.4	4.8	4.8	5.0	3.6	3.6	3.8
225	6.2	6.2		6.0	6.0	6.2	4.6	4.6	4.8	3.4	3.4	3.6
230	5.8	6.0		5.8	6.0		4.6	4.6	4.6	3.2	3.4	3.6
235	5.4	5.6		5.6	5.8		4.4	4.4	4.6	3.2	3.2	3.4
240				5.2	5.6		4.2	4.2	4.4	3.0	3.2	3.2
245				5.0	5.2		4.2	4.2	4.2	3.0	3.0	3.2
250				4.8	5.0		4.0	4.0		2.8	2.8	3.0
255				4.4	4.6		3.8	4.0		2.8	2.8	3.0
260				4.2	4.4		3.8	3.8		2.6	2.6	2.8
265				4.0	4.0		3.6	3.6		2.6	2.6	2.8
270					3.2		3.4	3.6		2.4	2.4	
275							3.2	3.4		2.4	2.4	
280							3.0	3.0		2.2	2.2	
285							2.6	2.6		2.2	2.2	
290							2.2	2.2		2.0	2.2	
295										2.0	2.0	

THIS CHART IS ONLY A GUIDE AND SHOULD NOT BE USED TO OPERATE THE CRANE.

Load charts

Hydraulic offsettable swingaway

Intermediate angle and loads for luffing

 68 m (223 ft)
 12-21-29-37 m (39-69-95-121 ft)
 51 000 kg (112,400 lb)
 26 ft 7 in spread (100%)
 360°

  Pounds x 1000

Radius	223' + 39.4'			223' + 68.9'			223' + 95.1'			223' + 121.4'		
	5°	5° - 20°	20° - 40°	5°	5° - 20°	20° - 40°	5°	5° - 20°	20° - 40°	5°	5° - 20°	20° - 40°
45	16.4											
50	16.4	16.4		10.0								
55	16.4	16.4		10.0			7.4					
60	16.4	16.4	16.4	10.0			7.4			5.0		
65	16.4	16.4	16.4	10.0			7.4			5.0		
70	16.4	16.4	16.4	10.0	10.0		7.4			5.0		
75	16.4	16.4	16.4	10.0	10.0		7.4	7.4		5.0		
80	16.4	16.4	16.4	10.0	10.0		7.4	7.4		5.0	5.0	
85	16.4	16.4	16.0	10.0	10.0		7.4	7.4		5.0	5.0	
90	16.4	16.2	15.6	10.0	10.0	9.4	7.4	7.4		5.0	5.0	
95	16.4	15.8	15.2	10.0	10.0	9.4	7.4	7.4	7.2	5.0	5.0	4.0
100	16.0	15.2	14.8	10.0	10.0	9.2	7.4	7.4	7.2	5.0	5.0	4.0
105	15.6	14.8	14.4	10.0	10.0	9.2	7.4	7.4	7.2	5.0	5.0	4.0
110	15.0	14.4	14.0	10.0	10.0	9.2	7.4	7.4	7.2	5.0	5.0	4.0
115	14.4	13.8	13.6	10.0	10.0	9.0	7.4	7.4	7.2	5.0	5.0	4.0
120	14.0	13.4	13.2	10.0	10.0	9.0	7.4	7.4	7.2	5.0	5.0	4.0
125	13.6	13.0	12.8	10.0	10.0	9.0	7.4	7.4	7.2	5.0	5.0	4.0
130	13.2	12.6	12.4	10.0	9.8	8.8	7.4	7.4	7.2	5.0	5.0	4.0
135	12.8	12.2	12.2	10.0	9.6	8.8	7.4	7.4	7.2	5.0	5.0	4.0
140	12.4	12.0	11.8	9.8	9.4	8.8	7.4	7.2	7.0	5.0	5.0	4.0
145	12.0	11.6	11.4	9.4	9.0	8.6	7.4	7.2	7.0	5.0	5.0	4.0
150	11.2	11.2	11.2	9.2	8.8	8.6	7.4	7.0	6.8	5.0	4.8	4.0
155	10.2	10.2	10.8	9.0	8.6	8.4	7.2	6.8	6.6	5.0	4.8	4.0
160	9.4	9.4	10.0	8.6	8.4	8.2	7.0	6.6	6.6	5.0	4.8	4.0
165	8.6	8.6	9.2	8.4	8.2	8.0	6.8	6.6	6.4	4.8	4.8	4.0
170	7.8	7.8	8.4	8.2	8.0	8.0	6.6	6.4	6.2	4.8	4.6	4.0
175	7.0	7.0	7.6	8.0	7.8	7.8	6.4	6.2	6.2	4.8	4.6	4.0
180	6.4	6.4	6.8	7.2	7.2	7.6	6.2	6.0	6.0	4.6	4.6	4.0
185	5.6	5.6	6.0	6.6	6.6	7.4	6.0	5.8	5.8	4.6	4.4	4.0
190	5.0	5.0	5.4	6.0	6.0	6.8	5.8	5.6	5.8	4.4	4.4	4.0
195	4.4	4.4	4.8	5.4	5.4	6.2	5.4	5.4	5.6	4.2	4.2	4.0
200	3.8	3.8		4.8	4.8	5.6	4.8	4.8	5.4	4.2	4.0	4.0
205	3.2	3.2		4.4	4.4	5.0	4.2	4.2	5.0	4.0	4.0	4.0
210	2.6	2.6		3.8	3.8	4.4	3.8	3.8	4.4	3.6	3.6	4.0
215	2.2	2.2		3.2	3.2	3.8	3.2	3.2	4.0	3.2	3.2	3.8
220				2.8	2.8	3.4	2.8	2.8	3.4	2.6	2.6	3.4
225				2.2	2.2	2.8	2.4	2.4	3.0	2.2	2.2	3.0
230							2.0	2.0	2.6			2.4
235									2.2			2.0

THIS CHART IS ONLY A GUIDE AND SHOULD NOT BE USED TO OPERATE THE CRANE.

The individual crane's load chart, operating instructions and other instructional plates must be read and understood prior to operating the crane.

Load charts

Hydraulic offsettable swingaway

Intermediate angle and loads for luffing

68 m
(223 ft)

12-21-29-37 m
(39-69-95-121 ft)

41 000 kg
(90,300 lb)

26 ft 7 in spread
(100%)

360°



Pounds (thousands)

Radius	223' + 39.4'			223' + 68.9'			223' + 95.1'			223' + 121.4'		
	5°	5° - 20°	20° - 40°	5°	5° - 20°	20° - 40°	5°	5° - 20°	20° - 40°	5°	5° - 20°	20° - 40°
45	16.4											
50	16.4	16.4		10.0								
55	16.4	16.4		10.0			7.4					
60	16.4	16.4	16.4	10.0			7.4			5.0		
65	16.4	16.4	16.4	10.0			7.4			5.0		
70	16.4	16.4	16.4	10.0	10.0		7.4			5.0		
75	16.4	16.4	16.4	10.0	10.0		7.4	7.4		5.0		
80	16.4	16.4	16.4	10.0	10.0		7.4	7.4		5.0	5.0	
85	16.4	16.4	16.0	10.0	10.0		7.4	7.4		5.0	5.0	
90	16.4	16.2	15.6	10.0	10.0	9.4	7.4	7.4		5.0	5.0	
95	16.4	15.8	15.2	10.0	10.0	9.4	7.4	7.4	7.2	5.0	5.0	4.0
100	16.0	15.2	14.8	10.0	10.0	9.2	7.4	7.4	7.2	5.0	5.0	4.0
105	15.6	14.8	14.4	10.0	10.0	9.2	7.4	7.4	7.2	5.0	5.0	4.0
110	15.0	14.4	14.0	10.0	10.0	9.2	7.4	7.4	7.2	5.0	5.0	4.0
115	14.4	13.8	13.6	10.0	10.0	9.0	7.4	7.4	7.2	5.0	5.0	4.0
120	13.8	13.4	13.2	10.0	10.0	9.0	7.4	7.4	7.2	5.0	5.0	4.0
125	12.6	12.6	12.8	10.0	10.0	9.0	7.4	7.4	7.2	5.0	5.0	4.0
130	11.6	11.6	12.4	10.0	9.8	8.8	7.4	7.4	7.2	5.0	5.0	4.0
135	10.4	10.4	11.2	10.0	9.6	8.8	7.4	7.4	7.2	5.0	5.0	4.0
140	9.4	9.4	10.2	9.8	9.4	8.8	7.4	7.2	7.0	5.0	5.0	4.0
145	8.6	8.6	9.2	9.4	9.0	8.6	7.4	7.2	7.0	5.0	5.0	4.0
150	7.6	7.6	8.4	8.6	8.6	8.6	7.4	7.0	6.8	5.0	4.8	4.0
155	6.8	6.8	7.4	7.8	7.8	8.4	7.2	6.8	6.6	5.0	4.8	4.0
160	6.0	6.0	6.6	7.0	7.0	8.2	6.8	6.6	6.6	5.0	4.8	4.0
165	5.4	5.4	6.0	6.2	6.2	7.4	6.2	6.2	6.4	4.8	4.8	4.0
170	4.8	4.8	5.2	5.6	5.6	6.6	5.4	5.4	6.2	4.8	4.6	4.0
175	4.0	4.0	4.6	5.0	5.0	6.0	4.8	4.8	6.0	4.6	4.6	4.0
180	3.4	3.4	4.0	4.4	4.4	5.4	4.2	4.2	5.2	4.0	4.0	4.0
185	2.8	2.8	3.4	3.8	3.8	4.6	3.6	3.6	4.6	3.6	3.6	4.0
190	2.4	2.4	2.8	3.2	3.2	4.0	3.2	3.2	4.0	3.0	3.0	4.0
195			2.2	2.8	2.8	3.6	2.6	2.6	3.6	2.6	2.6	3.4
200				2.2	2.2	3.0	2.2	2.2	3.0	2.0	2.0	2.8
205						2.4			2.4			2.4
210						2.0			2.0			2.0

THIS CHART IS ONLY A GUIDE AND SHOULD NOT BE USED TO OPERATE THE CRANE.

The individual crane's load chart, operating instructions and other instructional plates must be read and understood prior to operating the crane.

Working range

Heavy duty jib 6.6 ft

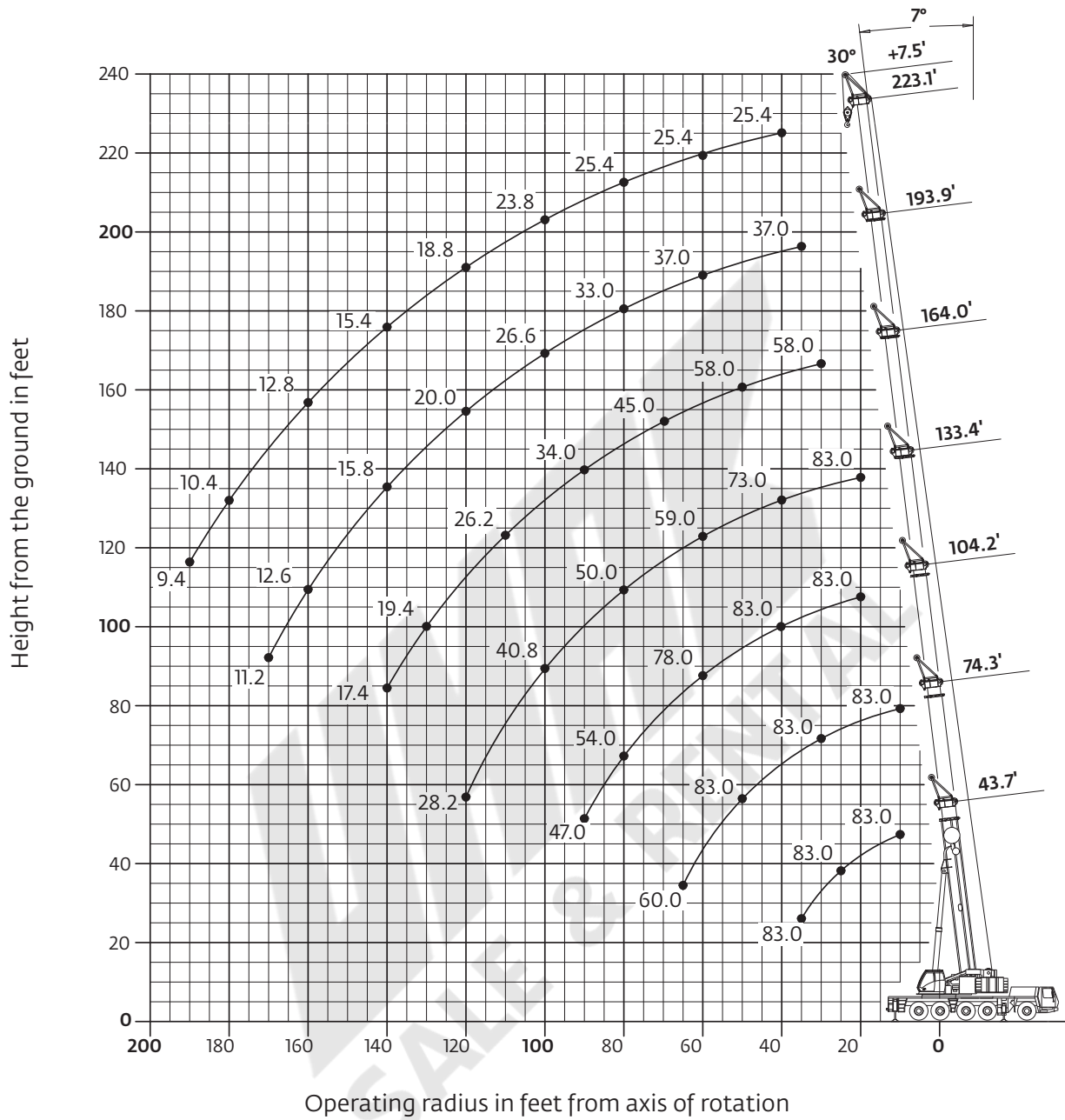

Hook heights shown in the working diagram do not consider loaded boom deflection.

THIS CHART IS ONLY A GUIDE AND SHOULD NOT BE USED TO OPERATE THE CRANE.

The individual crane's load chart, operating instructions and other instructional plates must be read and understood prior to operating the crane.

Load charts

Heavy duty jib

Fixed angle

 13,3 m-68 m
(44 ft-223 ft)

 2,3 m
(7.5 ft)

 77 000 kg
(169,700 lb)

 26 ft 7 in spread
(100%)

 360°



Pounds (thousands)

Radius	43.7' + 7.5'		74.3' + 7.5'		104.2' + 7.5'		133.4' + 7.5'		164.0' + 7.5'		193.9' + 7.5'		223.1' + 7.5'	
	8°	30°	8°	30°	8°	30°	8°	30°	8°	30°	8°	30°	8°	30°
10.0		83.0		83.0										
15.0		83.0		83.0										
20.0		83.0		83.0										
25.0		83.0		83.0		83.0		83.0						
30.0	83.0	83.0		83.0		83.0		81.0		58.0				
35.0	83.0	83.0		83.0		83.0		77.0		58.0				
40.0				83.0		83.0		73.0		58.0		37.0		25.4
45.0				83.0		83.0		69.0		58.0		37.0		25.4
50.0			83.0	83.0		83.0		65.0		58.0		37.0		25.4
55.0			83.0	83.0		83.0		62.0		55.0		37.0		25.4
60.0			74.0			78.0		59.0		52.0		37.0		25.4
65.0			60.0			71.0		57.0		49.0		37.0		25.4
70.0						65.0		54.0		45.0		36.6		25.4
75.0					59.0	59.0		52.0		42.2		34.8		25.4
80.0					54.0	54.0		50.0		38.8		33.0		25.4
85.0					51.0	51.0		47.0		36.2		31.2		25.4
90.0					45.0	47.0		46.0		34.0		29.8		25.4
95.0							44.0	43.4		31.8		28.2		24.6
100.0							40.6	40.8		29.6		26.6		23.8
105.0							37.4	37.6		27.8		24.8		22.4
110.0							34.4	34.6		26.2		23.0		21.0
115.0							31.8	32.0		24.6		21.2		19.6
120.0							28.2			22.6		20.0		18.8
125.0										20.6		18.8		17.8
130.0										19.4		17.8		17.0
135.0										18.4		16.8		16.2
140.0										17.4		15.8		15.4
145.0												15.0		14.6
150.0												14.0		14.0
155.0												13.4		13.4
160.0												12.6		12.8
165.0												11.8		12.2
170.0												11.2		11.6
175.0														11.0
180.0														10.4
185.0														10.0
190.0														9.4

THIS CHART IS ONLY A GUIDE AND SHOULD NOT BE USED TO OPERATE THE CRANE.

Load charts

Heavy duty jib

Fixed angle

- 
13,3 m-68 m
(44 ft-223 ft)
- 
2,3 m
(7.5 ft)
- 
51 000 kg
(112,400 lb)
- 
26 ft 7 in spread
(100%)
- 
360°

Radius	43.7' + 7.5'		74.3' + 7.5'		104.2' + 7.5'		133.4' + 7.5'		164.0' + 7.5'		193.9' + 7.5'		223.1' + 7.5'	
	8°	30°	8°	30°	8°	30°	8°	30°	8°	30°	8°	30°	8°	30°
10.0		83.0		83.0										
15.0		83.0		83.0										
20.0		83.0		83.0		83.0		83.0						
25.0		83.0		83.0		83.0		83.0						
30.0	83.0	83.0		83.0		83.0		81.0		58.0				
35.0	83.0	83.0		83.0		83.0		77.0		58.0		37.0		
40.0				83.0		83.0		73.0		58.0		37.0		25.4
45.0				83.0		83.0		69.0		58.0		37.0		25.4
50.0			78.0	79.0		81.0		65.0		58.0		37.0		25.4
55.0			67.0	68.0		72.0		62.0		55.0		37.0		25.4
60.0			57.0			64.0		59.0		52.0		37.0		25.4
65.0			52.0			57.0		54.0		48.0		37.0		25.4
70.0						51.0		48.0		43.4		36.6		25.4
75.0					45.0	45.0		43.6		39.2		34.8		25.4
80.0					40.0	40.6		39.6		35.4		33.0		25.4
85.0					36.0	36.4		36.2		32.0		31.2		25.4
90.0					32.4	32.8		32.8		29.0		28.8		25.4
95.0							29.2	29.6		26.4		26.2		24.6
100.0							26.4	26.8		24.0		23.8		23.8
105.0							24.0	24.2		21.8		21.8		22.4
110.0							22.2	22.0		19.8		19.8		20.8
115.0							20.8	20.4		17.8		18.2		19.2
120.0							20.0			16.0		17.0		17.6
125.0										14.4		16.2		16.2
130.0										12.8		15.4		14.8
135.0										12.0		14.6		13.6
140.0										11.4		14.0		12.6
145.0												13.4		11.4
150.0												12.4		10.4
155.0												11.4		9.4
160.0												10.4		8.4
165.0												9.8		7.6
170.0												9.0		6.8
175.0														6.0
180.0														5.2
185.0														4.4
190.0														3.8

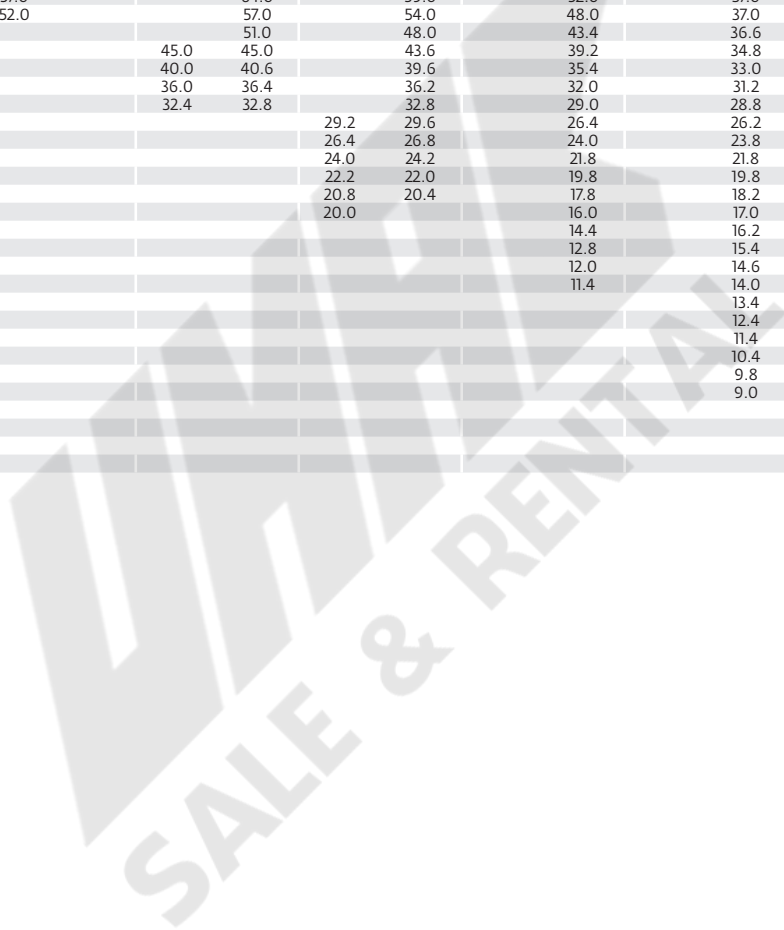

Symbols glossary



Axles



Counterweight



Grade



Gear



Boom



Drive



Heavy duty jib



Radius



Boom elevation



Electrical system



Hoist



Rotation



Boom extension



Engine



Hookblock



Speed



Boom length



Extension



Hydraulic system



Steering



Boom nose



Frame



Lights



Suspension



Brakes



Fuel tank capacity



Oil



Swing



Cab



Outriggers



Outrigger controls



Tires



Transmission

WORLDWIDE
SALE & RENTAL

Manitowoc Cranes

Regional headquarters

Americas

Manitowoc, Wisconsin, USA

Tel: +1 920 684 6621

Fax: +1 920 683 6277

Shady Grove, Pennsylvania, USA

Tel: +1 717 597 8121

Fax: +1 717 597 4062

Europe, Middle East, Africa

Dardilly, France

Tel: +33 (0)4 72 18 20 20

Fax: +33 (0)4 72 18 20 00

China

Shanghai, China

Tel: +86 21 6457 0066

Fax: +86 21 6457 4955

Greater Asia-Pacific

Singapore

Tel: +65 6264 1188

Fax: +65 6862 4040

Regional offices

Americas

Brazil

Alphaville

Mexico

Monterrey

Chile

Santiago

Europe, Middle East,

Africa

France

Baudemont

Cergy

Decines

Germany

Langenfeld

Italy

Lainate

Netherlands

Breda

Poland

Warsaw

Portugal

Baltar

Russia

Moscow

South Africa

Johannesburg

U.A.E.

Dubai

U.K.

Buckingham

China

Beijing

Chengdu

Guangzhou

Xian

Greater Asia-Pacific

Australia

Brisbane

Melbourne

Sydney

India

Chennai

Delhi

Hyderabad

Pune

Korea

Seoul

Philippines

Makati City

Singapore

Factories

Brazil

Passo Fundo

China

TaiAn

Zhangjiagang

France

Charlieu

Moulins

Germany

Wilhelmshaven

India

Pune

Italy

Niella Tanaro

Portugal

Baltar

Fânzeres

USA

Manitowoc

Port Washington

Shady Grove

This document is non-contractual. Constant improvement and engineering progress make it necessary that we reserve the right to make specification, equipment, and price changes without notice. Illustrations shown may include optional equipment and accessories and may not include all standard equipment.

Grove GMK5275

Product Guide



Features

- 13,3 m - 68 m (44 ft - 223 ft) seven-section full power MEGAFORM™ boom with TWIN-LOCK™ pinning
- 12 m - 21 m (39 ft - 69 ft) hydraulic offset bi-fold swingaway
- 2 x 8 m (26 ft) intermediate lattice inserts
- 77 t (169,700 lb) counterweight with hydraulic removal system
- MEGATRAK™ independent hydro-pneumatic suspension



Features

MEGATRAK™

The MEGATRAK™ suspension system is the best off road driveline available on the market today. The system's versatility and performance allows the GMK5275 to operate as a true all-terrain crane. The MEGATRAK™ independent suspension and all-wheel steer system allows wheels to remain on the ground at all times so stresses and weight are not continually transferred between axles. MEGATRAK™ provides true ground clearance where others just raise the chassis.

Other benefits of the MEGATRAK™ system are:

- A reliable suspension system
- Excellent job site maneuverability with all-wheel steering
- Commonality among almost all models
- A driveline that remains aligned at all times
- A steering linkage system that is protected against damage
- Constant tire contact for equal tire wear
- Reduced maintenance



TWIN-LOCK™

Boom pinning mechanism automatically pins the sections in position using two horizontal pins.

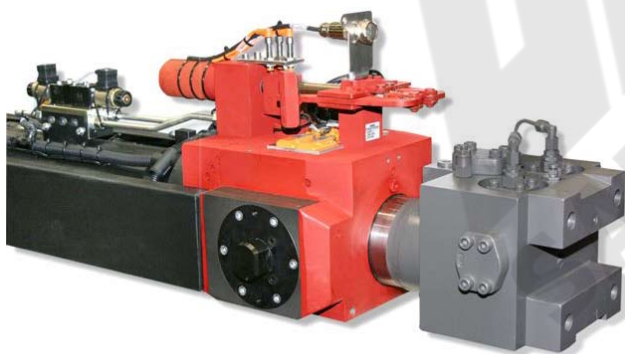

ECOS

Electronic Crane Operating System - ECOS enables control of the entire crane's principle operations. Simple programming eases lift planning and a supply of essential information allows full concentration on the lift itself.



EKS 5

The EKS 5 monitors the lifting conditions of the crane at all times and provides a full graphic display, rear lighting, graphic of boom telescoping percentage, and load charts.



Contents

Specifications (North American machine)	4
Dimensions (North American machine)	7
Weights (North American machine)	8
Specifications (European machine)	9
Dimensions (European machine)	12
Weights (European machine)	13
Counterweight	14
Working range (main boom)	15
Load charts (main boom)	16
Working range (swingaway)	19
Load charts (hydraulically offsettable swingaway)	20
Working range (heavy duty jib)	23
Load charts (heavy duty jib)	24
Symbols glossary	26

Specifications

North American version

Superstructure



Boom

13,3 m - 68 m (44 ft - 223 ft) 7-section, full power MEGAFORM™ boom with TWIN-LOCK™ Pinning. Maximum tip height: 71 m (233 ft).



Boom nose

Eight nylatron sheaves, mounted on heavy duty tapered roller bearings with removable pin-type rope guards. Quick reeve boom nose. Removable auxiliary boom nose with removable pin type rope guard.



Boom elevation

Single lift cylinder with safety valve provides boom angle from -1.5° to +83°.



*Hydraulic offsettable lattice extension

12 m - 21 m (39 ft - 69 ft) bi-fold lattice swingaway extension, hydraulically offsettable and luffing under load, 5°- 40°. Maximum tip height: 92 m (302 ft)



*Lattice inserts

2 x 8 m (26 ft) inserts for use with lattice swingaway extension to increase length to 29 m (95 ft) or 37 m (121 ft) Maximum tip height: 108 m (354 ft)



Load moment and anti-two block system

Load moment and anti-two block system with audio/visual warning and control lever lockout provides electronic display of boom angle, length, radius, tip height, relative load moment, maximum permissible load, load indication and warning of impending two-block condition.



Cab

All aluminum constructed cab with acoustical lining, hydraulic tilted to 20°. Includes tinted safety glass, adjustable operator's seat, opening windows at side and rear, hinged windshield with wiper, sun visor and window shade. Other features include hot water heater/defroster, armrest integrated crane controls and ergonomically arranged instrumentation.



Swing

3 planetary gear boxes with fixed displacement axial piston motors. Infinitely variable to 1.3 rpm. Free swing or hydrostatically engaged brake controlled by swing lever. Swing brake selected by foot operated switch.



Counterweight

77 t (169,700 lb) consisting of various sections with hydraulic installation/removal system controlled from the superstructure cab.



Engine

Cummins QSB6.7, 6 cylinder
Horsepower: 164 kW (220 bhp) at 2200 rpm
Torque: 949 Nm (700 ft/lb) at 1500 rpm
Engine emissions: EPA/CARB/EUROMOT (off road)



Fuel tank capacity

230 L (61 gal)



Electrical system

3 phase alternator: 28V/80A
2 batteries: 12V/170Ah



Hydraulic system

3 (three) separate circuits, 1 (one) axial piston variable displacement pump (load sensing) with electronic power limiting control for crane functions and 1 (one) double gear pump for slewing. Thermostatically controlled oil coolers keep oil at optimum operating temperature.
Hydraulic tank capacity: 915 L (242 gal)

Specifications

North American version

Superstructure continued

Hoist

Main and auxiliary hoist are powered by axial piston motor with planetary gear and brake. "Thumb-thumper" hoist drum rotation indicator alerts operator of hoist movement.

	Main	Auxiliary
Rope length:	290 m (951 ft)	290 m (951 ft)
Rope diameter:	22 mm	22 mm
Line speed:	125 m/min (410 fpm)	125 m/min (410 fpm)
Line pull:	93.5 kN (21,020 lb)	93.5 kN (21,020 lb)

*Optional equipment

- ▶ Work lights, mounted on boom base section
- ▶ Boom mounted aircraft warning light
- ▶ Radio/CD player for superstructure cab
- ▶ Stainless steel exhaust system with spark arrestor
- ▶ Air conditioning
- ▶ Hook blocks/headache ball
- ▶ Engine independent diesel cab heater, with engine pre-heater. Includes 24 hour timer.
- ▶ Additional cab mounted work light
- ▶ Strobe light
- ▶ Working range limiter
- ▶ Data logger
- ▶ 360° NYC swing lock
- ▶ 2,0 m (6.6 ft) side stowed heavy duty jib with 19 t (41,900 lb) maximum capacity using two parts of line, offset 0° and 25°
- ▶ 2,3 m (7.5 ft) side stowed heavy duty jib with 38 t (83,000 lb) maximum capacity using four parts of line, offset 8° and 30°
- ▶ EKS5 Light semi-graphic display in lieu of standard EKS5

Carrier

Chassis

Box type, torsion resistant frame is fabricated from high strength steel.

Outrigger system

Four hydraulic two stage outrigger beams with vertical cylinders and outrigger pads, 600 mm (23.6 in) square . Outrigger can be set in 5 positions:

Full:	8,1 m (26.6 ft)
Partial:	6,8 m (22.4 ft)
Partial:	5,6 m (18.4 ft)
Partial:	4,4 m (14.4 ft)
Retracted:	2,7 m (9.0 ft)

Independent horizontal and vertical movement controlled from each side of carrier and the superstructure cab. Electronic crane level indicators. Hydraulic disconnect for all outrigger beams.

Transmission

Allison automatic 4000 SP, 6 speeds forward, 1 reverse
2 speed transfer case

Drive/steer

10x6x10

Axles

1st axle line – steer
2nd axle line – steer/(optional drive)
3rd axle line – drive/steer (permanent drive with 10x6, disconnects for highway with 10x8)
4th axle line – drive/steer (connects for all wheel steer)
5th axle line – drive/steer

Drive axles with planetary hub reduction and center mounted gearing. Standard inter-axle and cross axle differential locks.

Suspension

Grove exclusive MEGATRAK™ suspension. Independent hydro-pneumatic system acting on all wheels with hydraulic lockout. Suspension can be raised 160 mm (6.3 in) or lowered 120 mm (4.7 in), both longitudinally and transversely. Features an automatic leveling system for highway travel.

Specifications

North American version

Carrier continued

Tires

10 tires, 16.00R25 (Vehicle width – 3,0 m [9.8 ft])

Steering

Dual circuit, hydraulic power assisted steering system. Transfer case mounted, ground driven emergency steering pump. Axles 1, 2, 3 and 5 steer on highway. Separate steering (steer by wire) of the 4th and 5th axles for all wheel and crab steering, controlled by an electronic rocker switch.

Engine

Cummins QSX15, 6 cylinder

Horsepower: 399 kW (535 bhp) at 2100 rpm

Torque: 2539 Nm (1873 ft/lb) at 1400 rpm

Engine emissions: EPA /CARB/EUROMOT (off road)

Standard compression brake, disconnected when hydraulic transmission retarder is optioned

Fuel tank capacity

397 L (105 gal)

Brakes

Service brakes: pneumatic dual circuit acting on all wheels.

Parking brake: pneumatically operated spring loaded brake acting on axle lines 2, 3, 4 and 5.

Air dryer.

Cab

Two-man, aluminum construction with the following features: safety glass, driver seat with pneumatic suspension, engine-dependent hot water heater, power windows, heated rear view mirrors, complete instrumentation and driving controls.

Electrical system

24V system with three phase alternator, 28V/100A

2 batteries, 12V/170 Ah

Maximum speed

85 km/h (53 mph)

Gradeability (theoretical)

50% - 14.00 tires

45% - 16.00/20.5 tires

Miscellaneous standard equipment

Work light; tool kit; fire extinguishers; auxiliary boom nose; radio/CD player in carrier cab, heated rear view mirrors, wind speed indicator.

*Optional equipment

- ▶ Stainless steel exhaust system with spark arrestor
- ▶ Air conditioning
- ▶ 14.00R25 tires (vehicle width. 3 m [9.8 ft])
- ▶ 20.5R25 tires (vehicle width. 3,1 m [10.2 ft])
- ▶ 10x8x10 drive/steer
- ▶ Transmission retarder (in lieu of engine compression brake)
- ▶ Engine independent diesel cab heater, with engine pre-heater. Includes 24 hour timer.
- ▶ Strobe light
- ▶ Work lights for outriggers
- ▶ Spare tire and wheel with carry bracket
- ▶ Rear mounted stowage box
- ▶ Outrigger pad load indicator
- ▶ Trailer hitch
- ▶ Steel outrigger pads

Dimensions

North American version

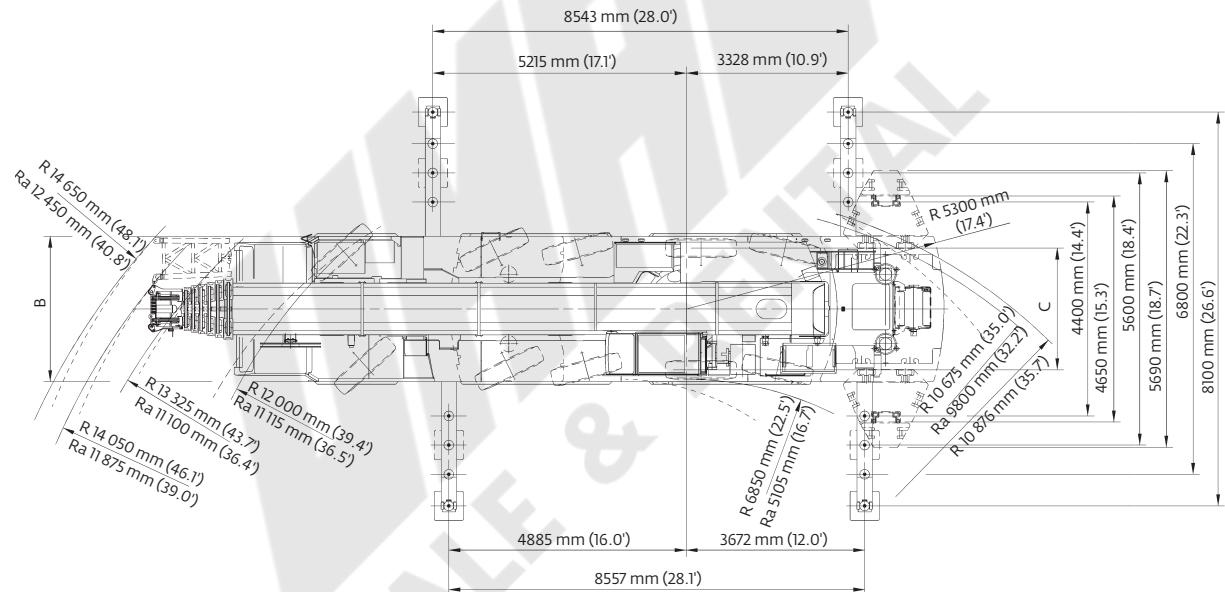
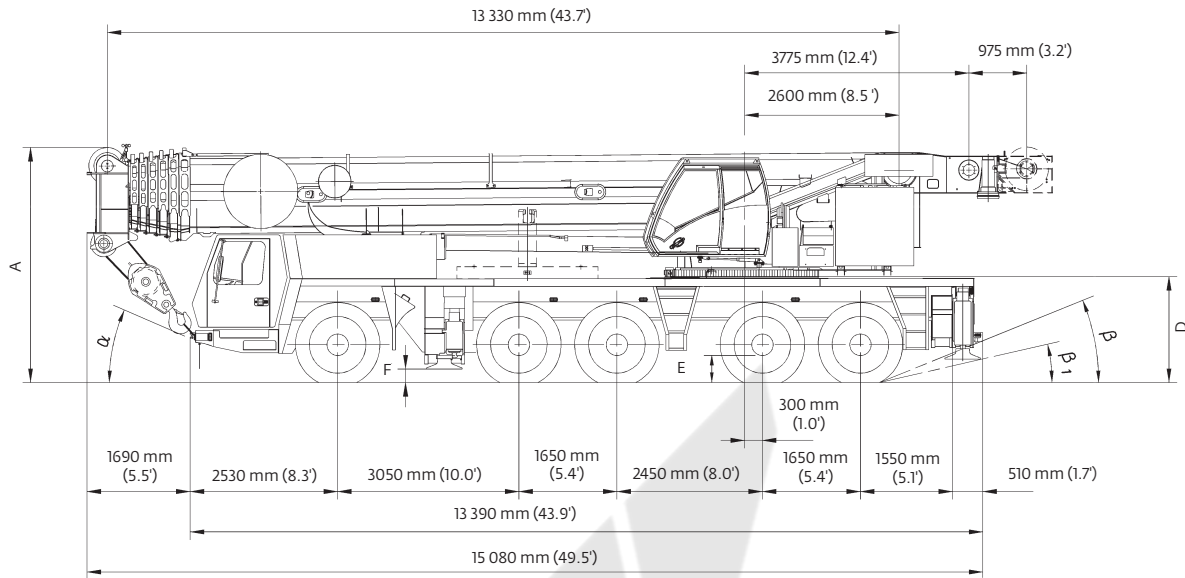

Tires	A	A <small>*130 mm (0.4)</small>	B	C	D	E	F	α	β	β_1
14.00 R25	3950 mm (13')	3820 mm (12.5')	2990 mm (9.8')	2570 mm (8.4')	1780 mm (5.8')	400 mm (1.3')	228 mm (0.7')	23°	22°	13°
16.00 R25	4000 mm (13.1')	3870 mm (12.7')	3000 mm (9.8')	2510 mm (8.2')	1830 mm (6.0')	450 mm (1.5')	258 mm (0.8')	25°	24°	15°
20.5 R25	4000 mm (13.1')	3870 mm (12.7')	3000 mm (9.8')	2530 mm (8.3')	1830 mm (6.0')	450 mm (1.5')	258 mm (0.8')	25°	24°	15°

Ra = Radius all wheels steered
 °Lowered

Weights

North American version

Trailing boom

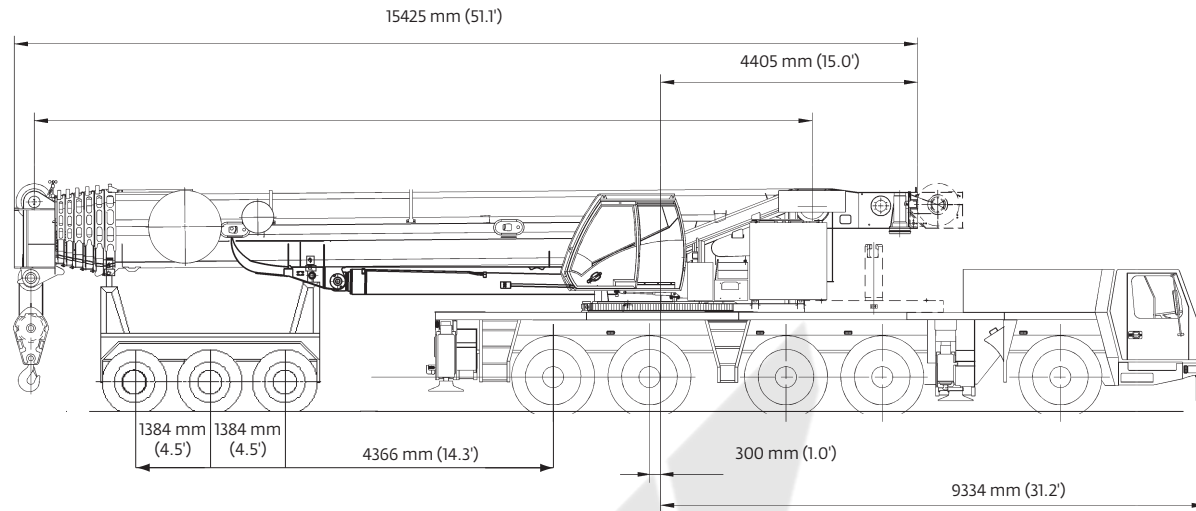

Basic weights - kg (lb)	Axles 1-3		Axles 4 and 5		Dolly		Total	
GMK 5275 Cummins power with: 20.5R25 tires, 10x8x10 drive/steer, 11 m - 18m (36 ft - 59 ft) hydraulic luffing swingaway, 2nd oil cooler, outrigger pads, auxiliary hoist, driver and tanks filled, 3 axle boom dolly (4309 kg / 9400 lb)	30 877	(68,072)	18 123	(39,954)	20 079	(44,267)	69 079	(152,293)
Additions:								
5000 kg (11 000 lb) section pinned to superstructure (special counterweight version)	4845	(10,681)	155	(342)	0	(0)	5000	(11,023)
11 000 kg (24,250 lb) base section stowed on carrier	10 660	(23,501)	340	(750)	0	(0)	11 000	(24,251)
Removals:								
Brackets for hydraulic swingaway incl. hose reel	- 9	(-20)	- 4	(-9)	- 257	(-567)	- 270	(-595)
11 m - 18 m (36 ft - 59 ft) hydraulic swingaway	- 360	(-794)	- 161	(-355)	-1489	(-3283)	-2010	(-4431)
Front outriggers	-2165	(-4773)	275	(606)	0	(0)	-1890	(-4167)
Rear outriggers	1031	(2273)	-3371	(-7432)	0	(0)	-2340	(-5159)
Front and rear outrigger floats	- 70	(-154)	-130	(-287)	0	(0)	- 200	(-441)
Substitutions:								
10x6x10 drive/steer	- 319	(-703)	- 36	(-79)	0	(0)	- 355	(-783)
14.00R25 tires	- 612	(-1349)	- 408	(-899)	0	(0)	-1020	(-2249)
16.00R25 tires	- 252	(-556)	- 168	(-370)	0	(0)	- 420	(-926)

Boom over front

Basic Weights - kg (lb)	Axles 1 - 3		Axles 4 and 5		Total	
Cummins power, 16.00R25 tires, 10x6x10 drive/steer, 2nd oil cooler, outrigger pads, driver and tanks filled	37 809	(83,355)	22 126	(48,779)	59 935	(132,134)
Additions:						
10x8x10 drive/steer	319	(703)	36	(79)	355	(783)
Spare wheel 14.00 R25 XGC steel rim with stowage	- 124	(-273)	384	(847)	260	(573)
Spare wheel 16.00 R25 XGC steel rim with stowage	- 153	(-337)	473	(1043)	320	(705)
Spare wheel 20.5 R25 XGC steel rim with stowage	- 173	(-381)	535	(1179)	362	(798)
Brackets for hydraulic swingaway	91	(201)	- 11	(-24)	80	(176)
Hose reel + parts for hydraulic swingaway	327	(721)	- 137	(-302)	190	(419)
11 m - 18 m (36 ft - 59 ft) hydraulic swingaway	2295	(5060)	- 285	(-628)	2010	(4431)
Auxiliary hoist	-1154	(-2544)	2894	(6380)	1740	(3836)
11 000 kg (24,250 lb) base plate stowed on carrier	10 611	(23,393)	339	(747)	10 950	(24,141)
5000 kg (11,000 lb) slab fixed to turntable (special counterweight version)	-2748	(-6058)	7728	(17,037)	4980	(10,979)
Substitutions:						
14.00R25 tires	- 360	(-794)	- 240	(-529)	- 600	(-1323)
20.5R25 tires	252	(556)	168	(370)	420	(926)
Removals:						
Boom assembly w/o lift cylinder	-19 776	(-43,599)	-1359	(-2996)	-21 135	(-46,595)
Front outriggers	-2187	(-4822)	277	(611)	-1910	(-4211)
Rear outriggers	1022	(2253)	-3342	(-7368)	-2320	(-5115)
Front and rear outrigger floats	- 70	(-154)	- 130	(-287)	- 200	(-441)

Specifications

European version

Superstructure



Boom

13,3 m - 68 m (44 ft - 223 ft) 7-section, full power MEGAFORM™ boom with TWINLOCK™ Pinning.
Maximum tip height: 71 m (233 ft)



Boom nose

Eight nylatron sheaves, mounted on heavy duty tapered roller bearings with removable pin-type rope guards. Quick Reeve boom nose. Removable auxiliary boom nose with removable pin type rope guard.



Boom elevation

Single lift cylinder with safety valve provides boom angle from -1.5° to +83°.



*Hydraulic offsettable lattice extension

12 m - 21 m (39 ft - 69 ft) bi-fold lattice swingaway extension, hydraulically offsettable and luffing under load, 5° - 40°.

Maximum tip height: 92 m (302 ft)



*Lattice inserts

2 x 8 m (26 ft) inserts for use with lattice swingaway extension to increase length to 29 m (95 ft) or 37 m (121 ft)

Maximum tip height: 108 m (354 ft)



Load moment and anti-two block system

Load moment and anti-two block system with audio/visual warning and control lever lockout provides electronic display of boom angle, length, radius, tip height, relative load moment, maximum permissible load, load indication and warning of impending two-block condition.



Cab

All aluminum constructed cab with acoustical lining, hydraulic tilted to 20°. Includes tinted safety glass, adjustable operator's seat, opening windows at side and rear, hinged windshield with wiper, sun visor and window shade. Other features include diesel heater/defroster, armrest integrated crane controls and ergonomically arranged instrumentation.



Swing

3 planetary gear boxes with fixed displacement axial piston motors. Infinitely variable to 1.3 rpm. Free swing or hydrostatically engaged brake controlled by swing lever. Swing brake selected by foot operated switch.



Counterweight

77 t (169,700 lb) consisting of various sections with hydraulic installation/removal system controlled from the superstructure cab.



Engine

Mercedes OM 906 LA, 6 cylinder

Horsepower: 170 kW (228 bhp) at 2200 rpm

Torque: 810 Nm (597 ft/lb) at 1200 rpm

Engine emissions: EPA/CARB/EUROMOT (off road)



Fuel tank capacity

Supplied from chassis fuel tank.



Electrical system

3 phase alternator: 28V/80A

2 batteries: 12V/170Ah



Hydraulic system

2 separate circuits, 1 axial piston variable displacement pump (load sensing) with electronic power limiting control for crane functions and 1 double gear pump for slewing. Thermostatically controlled oil coolers keep oil at optimum operating temperature.

Hydraulic tank capacity: 915 L (242 gal)

Specifications

European version

Superstructure continued



Hoist

Main and auxiliary hoist are powered by axial piston motor with planetary gear and brake. "Thumb-thumper" hoist drum rotation indicator alerts operator of hoist movement.

	Main	Auxiliary
Rope length:	290 m (951 ft)	290 m (951 ft)
Rope diameter:	22 mm	22 mm
Line speed:	125 m/min (410 fpm)	125 m/min (410 fpm)
Line pull:	93.5 kN (21,020 lb)	93.5 kN (21,020 lb)

*Optional equipment

- ▶ Work lights, mounted on boom base section
- ▶ Boom mounted aircraft warning light
- ▶ Radio/CD player for superstructure cab
- ▶ Stainless steel exhaust system with spark arrestor
- ▶ Air conditioning
- ▶ Hook blocks/headache ball
- ▶ Engine independent diesel cab heater, with engine pre-heater. Includes 24 hour timer.
- ▶ Additional cab mounted work light
- ▶ Strobe light
- ▶ Working range limiter
- ▶ Data logger
- ▶ 360° NYC swing lock
- ▶ 2,0 m (6.6 ft) side stowed heavy duty jib with 19 t (41,900 lb) maximum capacity using two parts of line, offset 0° and 25°
- ▶ 2,3 m (7.5 ft) side stowed heavy duty jib with 38 t (83,000 lb) maximum capacity using four parts of line, offset 8° and 30°
- ▶ EKS5 Light semi-graphic display in lieu of standard EKS5

Carrier



Chassis

Box type, torsion resistant frame is fabricated from high strength steel.



Outrigger system

Four hydraulic two stage outrigger beams with vertical cylinders and outrigger pads, 600 mm (23.6 in) square. Outrigger can be set in 5 positions:

Full:	8,1 m (26.6 ft)
Partial:	6,8 m (22.3 ft)
Partial:	5,6 m (18.4 ft)
Partial:	4,4 m (14.4 ft)
Retracted:	2,7 m (9.0 ft)

Independent horizontal and vertical movement controlled from each side of carrier and the superstructure cab. Electronic crane level indicators. Hydraulic disconnect for all outrigger beams



Transmission

Allison automatic 4000 SP, 6 speeds forward, 1 reverse 2 speed transfer case



Drive/steer

10 x 6 x 10



Axles

- 1st axle line – steer
- 2nd axle line – steer/(optional drive)
- 3rd axle line – drive/steer (permanent drive with 10 x 6, disconnects for highway with 10 x 8)
- 4th axle line – drive/steer (connects for all wheel steer)
- 5th axle line – drive/steer

Drive axles with planetary hub reduction and center mounted gearing. Standard inter-axle and cross axle differential locks.



Suspension

Grove exclusive MEGATRAK™ suspension. Independent hydro-pneumatic system acting on all wheels with hydraulic lockout. Suspension can be raised 160 mm (6.3 in) or lowered 120 mm (4.7 in), both longitudinally and transversely. Features an automatic leveling system for highway travel.

Specifications

European version

Carrier continued

Tires

10 tires, 16.00R25 (Vehicle width – 3,0 m [9.8 ft])

Steering

Dual circuit, hydraulic power assisted steering system. Transfer case mounted, ground driven emergency steering pump. Axles 1, 2, 3 and 5 steer on highway. Separate steering (steer by wire) of the 4th and 5th axles for all wheel and crab steering, controlled by an electronic rocker switch.

Engine

Mercedes OM 502 LA, 8 cylinder
Horsepower: 420 kW (563 bhp) at 1800 rpm
Torque: 2700 Nm (1991 ft/lb) at 1200 rpm
Engine emissions: EPA/CARB/EUROMOT (off road)

Fuel tank capacity

515 L (136 gal). Supplies superstructure and carrier engines.

Brakes

Service brakes: pneumatic dual circuit acting on all wheels.
Parking brake: pneumatically operated spring loaded brake acting on axle lines 2, 3, 4 and 5.
Air dryer

Cab

Two-man, aluminum construction with the following features: safety glass, driver seat with pneumatic suspension, engine-dependent hot water heater, power windows, heated rear view mirrors, complete instrumentation and driving controls.

Electrical system

24V system with three phase alternator, 28V/100A
2 batteries, 12V/170 Ah

Maximum speed

85 km/h (53 mph)

Gradeability (theoretical)

50% - 14.00 tires
45% - 16.00/20.5 tires

Miscellaneous standard equipment

Work light; tool kit; fire extinguishers; auxiliary boom nose; radio /CD player in carrier cab, heated rear view mirrors, wind speed indicator.

*Optional equipment

- Stainless steel exhaust system with spark arrestor
- Air conditioning
- 14.00R25 tires (vehicle width. 3 m [9.8 ft])
- 20.5R25 tires (vehicle width. 3,1 m [10.2 ft])
- 10x8x10 drive/steer
- Transmission retarder (in lieu of engine compression brake)
- Engine independent diesel cab heater, with engine pre-heater. Includes 24 hour timer.
- Strobe light
- Work lights for outriggers
- Spare tire and wheel with carry bracket
- Rear mounted stowage box
- Outrigger pad load indicator
- Trailer hitch
- Steel outrigger pads

Dimensions

European version

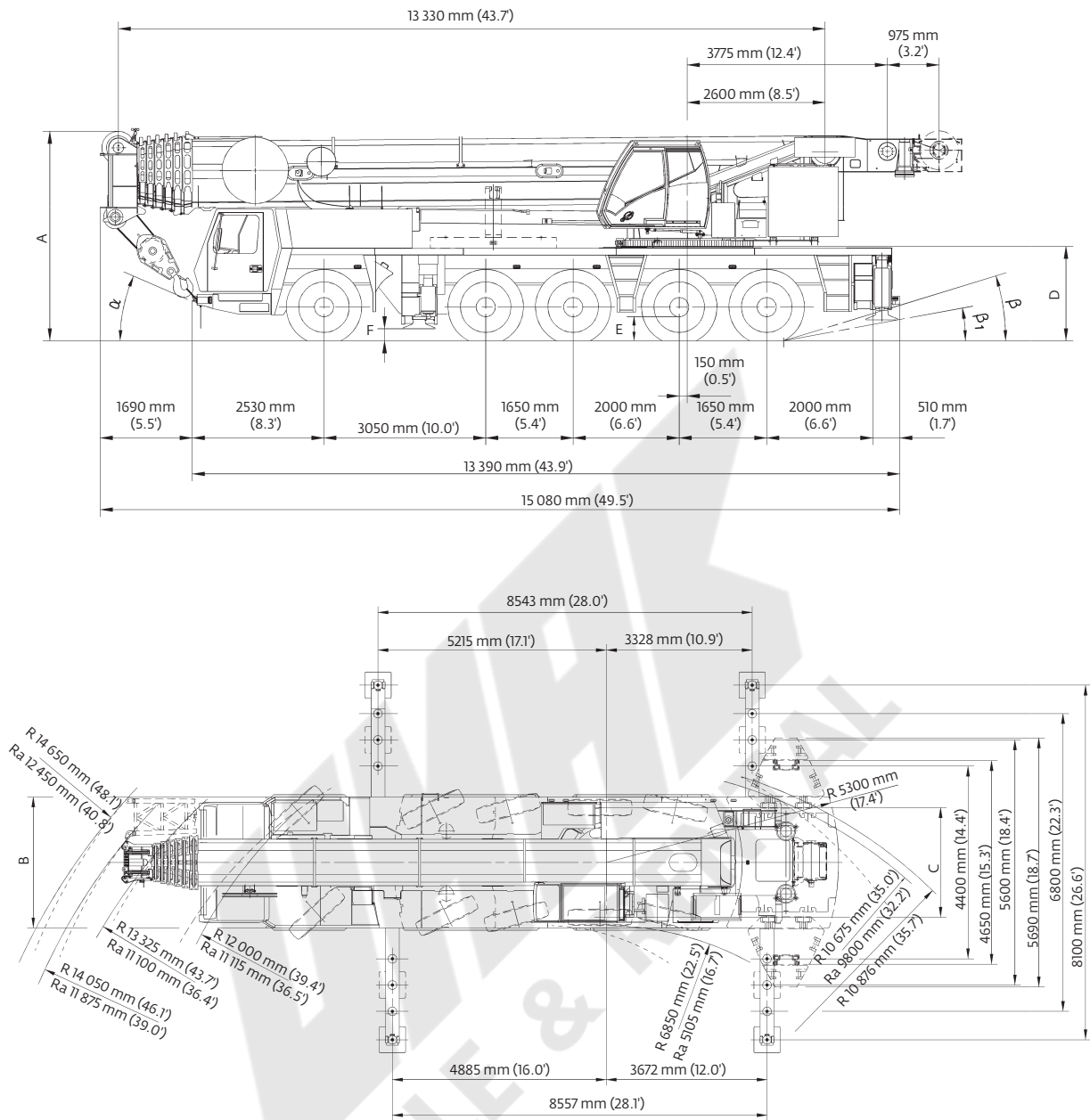

Tires	A	A ^{130 mm (0.4)}	B	C	D	E	F	α	β	β_1
14.00 R25	3950 mm (13')	3820 mm (12.5')	2990 mm (9.8')	2570 mm (8.4')	1780 mm (5.8')	400 mm (1.3')	228 mm (0.7')	23°	15°	10°
16.00 R25	4000 mm (13.1')	3870 mm (12.7')	3000 mm (9.8')	2510 mm (8.2')	1830 mm (6.0')	450 mm (1.5')	258 mm (0.8')	25°	17°	12°
20.5 R25	4000 mm (13.1')	3870 mm (12.7')	3000 mm (9.8')	2530 mm (8.3')	1830 mm (6.0')	450 mm (1.5')	258 mm (0.8')	25°	17°	12°

Ra = Radius all wheels steered
 °Lowered

Weights

European version

Trailing boom

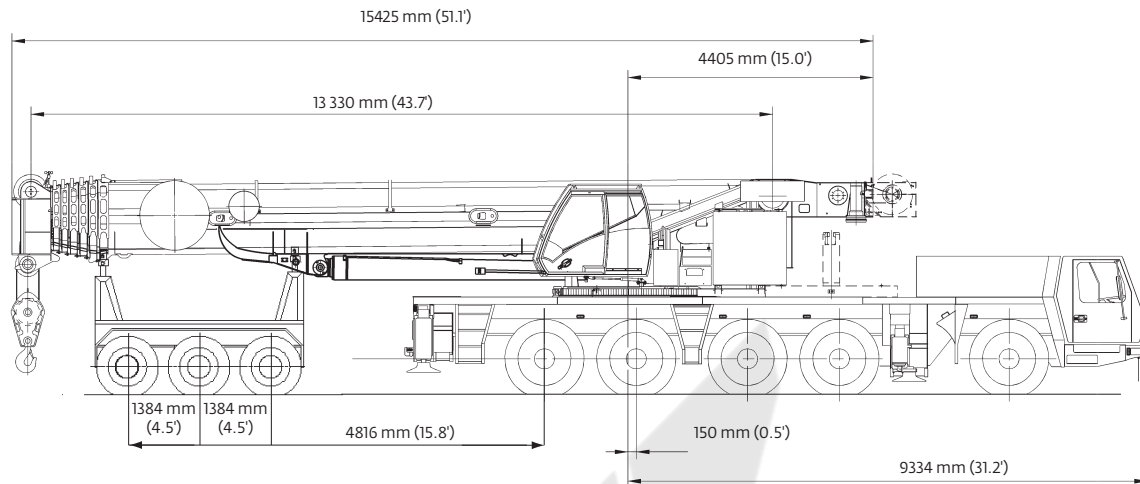

Basic weights - kg (lb)	Axles 1-3		Axles 4 and 5		Dolly		Total	
GMK 5275 Mercedes power with: 20.5R25 tires, 10x8x10 drive/steer, 11 m-18m (36-59 ft) hydraulic luffing swingaway, 2nd oil cooler, outrigger pads, auxiliary hoist, driver and tanks filled, 3 axle boom dolly (4309 kg / 9400 lb)	27 881	(61,467)	20 119	(44,355)	20 079	(44,267)	68 079	(150,089)
Additions:								
5000 kg (11 000 lb) section pinned to superstructure (special counterweight version)	4831	(10,651)	169	(373)	0	(0)	5000	(11,023)
11 000 kg (24,250 lb) base section stowed on carrier	10 629	(23,433)	371	(818)	0	(0)	11 000	(24,251)
Removals:								
Brackets for hydraulic swingaway incl. hose reel	- 8	(-18)	- 4	(-9)	- 257	(-567)	- 270	(-595)
11 m - 18 m (36 ft - 59 ft) hydraulic swingaway	- 345	(-761)	- 176	(-388)	-1489	(-3283)	-2010	(-4431)
Front outriggers	-2190	(-4828)	300	(661)	0	(0)	-1890	(-4167)
Rear outriggers	1338	(2950)	-3678	(-8109)	0	(0)	-2340	(-5159)
Front and rear outrigger floats	- 59	(-130)	- 141	(-311)	0	(0)	- 200	(-441)
Substitutions:								
10x6x10 drive/steer	- 316	(-697)	- 39	(-86)	0	(0)	- 355	(-783)
14.00R25 tires	- 612	(-1349)	- 408	(-899)	0	(0)	-1020	(-2249)
16.00R25 tires	- 252	(-556)	- 168	(-370)	0	(0)	- 420	(-926)

Boom over front

Basic weights - kg (lb)	Axles 1 - 3		Axles 4 and 5		Total	
Mercedes power, 16.00R25 tires, 10x6x10 drive/steer, 2nd oil cooler, outrigger pads, driver and tanks filled	34 340	(75,707)	24 645	(54,333)	58 985	(130,040)
Additions:						
10x8x10 drive/steer	316	(697)	39	(86)	355	(783)
Spare wheel 14.00 R25 XGC steel rim with stowage	- 186	(-410)	446	(983)	260	(573)
Spare wheel 16.00 R25 XGC steel rim with stowage	- 229	(-505)	549	(1210)	320	(705)
Spare wheel 20.5 R25 XGC steel rim with stowage	- 259	(-571)	621	(1369)	362	(798)
Brackets for hydraulic swingaway	92	(203)	- 12	(-26)	80	(176)
Hose reel + parts for hydraulic swingaway	339	(747)	- 149	(-328)	190	(419)
11 m - 18 m (36 ft - 59 ft) hydraulic swingaway	2321	(5117)	- 311	(-686)	2010	(4431)
Auxiliary hoist	-1417	(-3124)	3157	(6960)	1740	(3836)
11 000 kg (24,250 lb) base plate stowed on carrier	10 581	(23,327)	369	(814)	10 950	(24,141)
5000 kg (11,000 lb) slab fixed to turntable (special counterweight version)	-3452	(-7610)	8432	(18,589)	4980	(10,979)
Substitutions:						
14.00R25 tires	- 360	(-794)	- 240	(-529)	- 600	(-1323)
20.5R25 tires	252	(556)	168	(370)	420	(926)
Removals:						
Boom assembly w/o lift cylinder	-19 612	(-43,237)	-1523	(-3358)	-21 135	(-46,595)
Front outriggers	-2213	(-4879)	303	(668)	-1910	(-4211)
Rear outriggers	1326	(2923)	-3646	(-8038)	-2320	(-5115)
Front and rear outrigger floats	- 59	(-130)	- 141	(-311)	- 200	(-441)

Counterweight

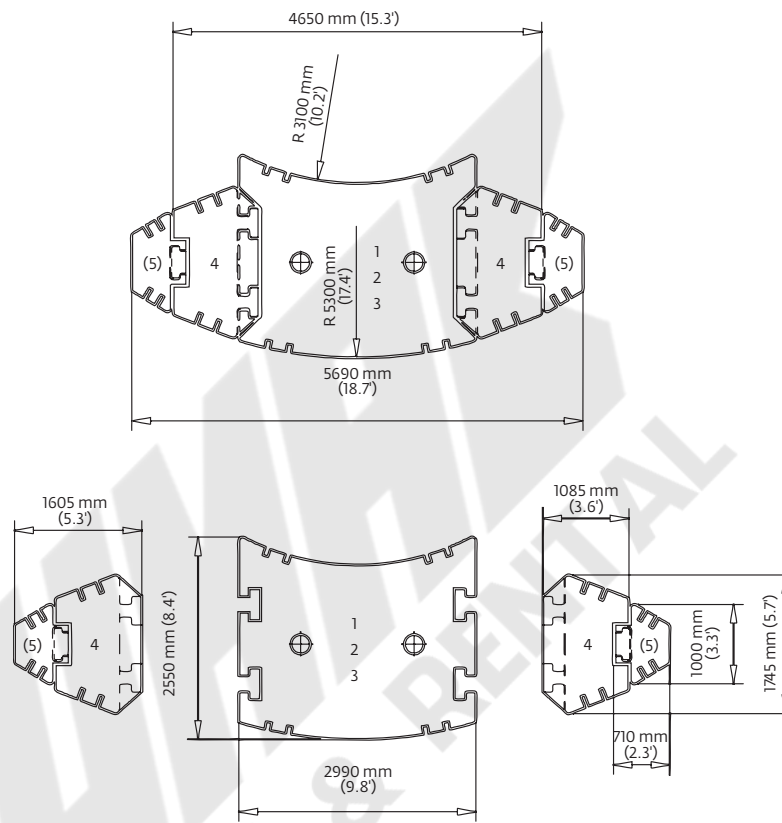
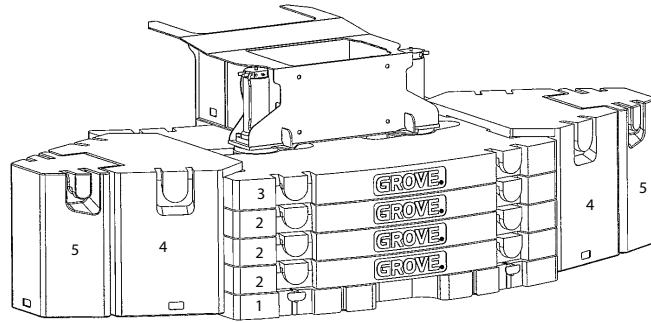

Counterweight Configuration kg (lb)

	1 (Baseplate)	2 (Stackable)	3 (Stackable)	4 (Wing)	5 (Wing)
	11 000 (24,200)	10 000 (22,046)	10 000 (22,046)	10 000 (22,046)	3000 (6600)
11 000 (24,200)	•				
21 000 (46,200)	•	•			
31 000 (68,300)	•	X2			
41 000 (90,300)	•	X3			
51 000 (112,400)	•	X3	•		
71 000 (156,500)	•	X3	•	X2	
77 000 (169,700)	•	X3	•	X2	X2

Working range

44 ft - 223 ft main boom

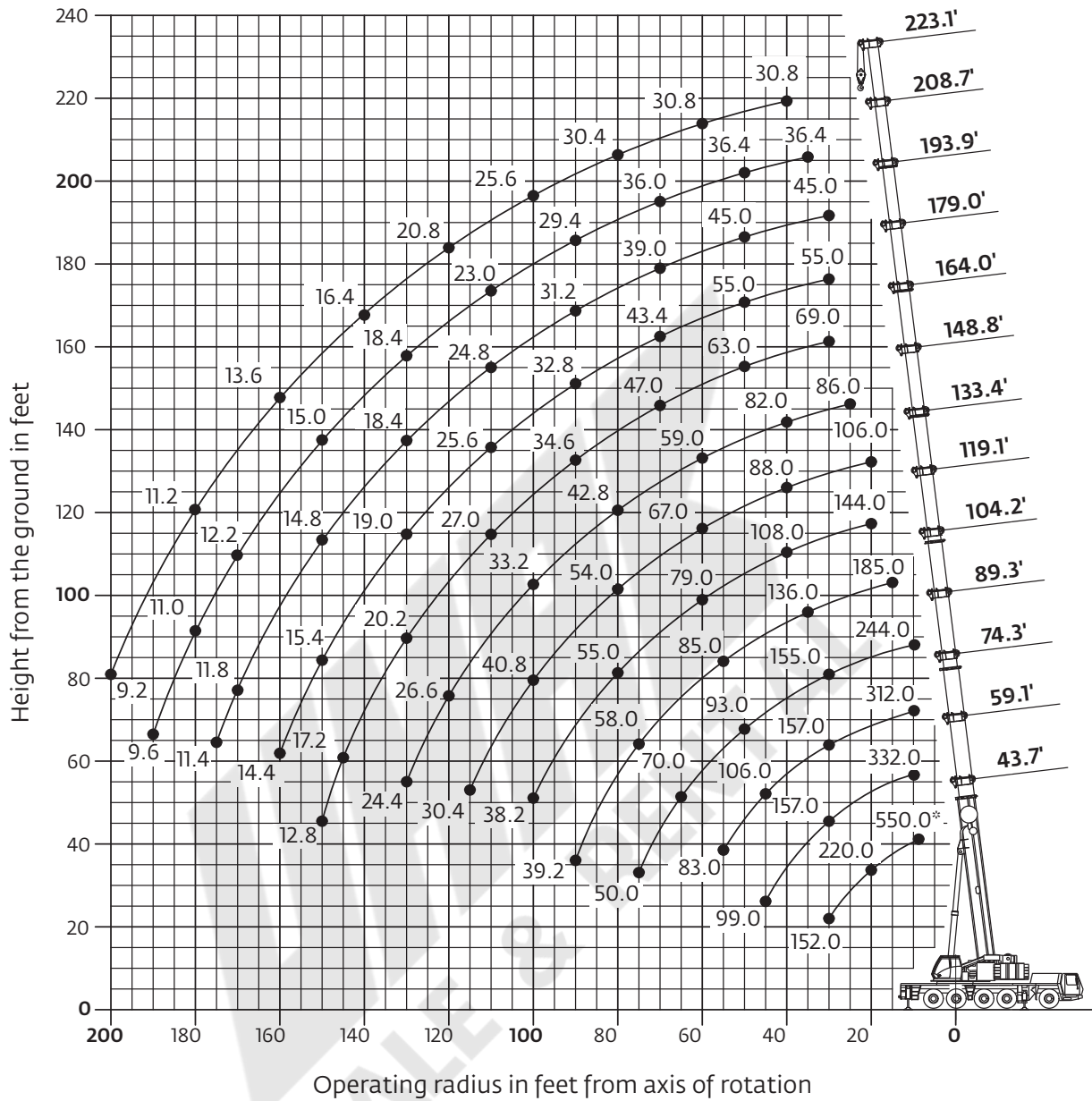

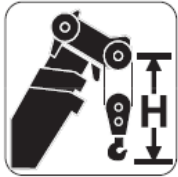
	Hook block	H
		200 ton, 9 sheave
	160 ton, 7 sheave	12.0 ft (3650 mm)
	125 ton, 5 sheave	10.8 ft (3300 mm)
	80 ton, 3 sheave	10.8 ft (3300 mm)
	32 ton, 1 sheave	10.5 ft (3200 mm)
	12 ton, single line headache ball	8.0 ft (2450 mm)

THIS CHART IS ONLY A GUIDE AND SHOULD NOT BE USED TO OPERATE THE CRANE.

Load charts

Main boom



13,3 m - 68 m
 (44 ft - 223 ft)

77 000 kg
 (169,700 lb)

26 ft 7 in spread
 (100%)

360°



 Pounds x 1000

Feet	43.7'	59.1'	74.3'	89.3'	104.2'	119.1'	133.4'	148.8'	164.0'	179.0'	193.9'	208.7'	223.1'
8	*550.0												
10	346.0	332.0	312.0	244.0									
15	272.0	270.0	260.0	242.0	185.0								
20	220.0	222.0	215.0	212.0	182.0	144.0	106.0						
25	184.0	185.0	181.0	181.0	166.0	140.0	106.0	86.0					
30	152.0	157.0	157.0	155.0	151.0	129.0	105.0	86.0	69.0	55.0	45.0		
35		136.0	136.0	135.0	136.0	118.0	96.0	86.0	69.0	55.0	45.0	36.4	
40		121.0	119.0	118.0	120.0	108.0	88.0	82.0	69.0	55.0	45.0	36.4	30.8
45		99.0	106.0	104.0	106.0	99.0	81.0	75.0	68.0	55.0	45.0	36.4	30.8
50			95.0	93.0	95.0	92.0	76.0	70.0	63.0	55.0	45.0	36.4	30.8
55			83.0	84.0	85.0	85.0	72.0	64.0	59.0	52.0	45.0	36.4	30.8
60				76.0	77.0	79.0	67.0	59.0	54.0	49.0	44.0	36.4	30.8
65				70.0	70.0	72.0	63.0	54.0	50.0	46.0	41.2	36.4	30.8
70				63.0	64.0	66.0	60.0	50.0	47.0	43.4	39.0	36.0	30.8
75				50.0	58.0	61.0	57.0	46.0	43.0	40.4	36.8	34.4	30.8
80					53.0	55.0	54.0	42.8	39.6	37.6	34.8	32.6	30.4
85					49.0	51.0	51.0	40.2	37.2	35.2	33.0	31.0	29.2
90					39.2	46.0	48.0	37.6	34.6	32.8	31.2	29.4	28.0
95						42.4	44.0	35.2	32.4	30.8	29.4	28.0	26.8
100						38.2	40.8	33.2	30.4	28.8	27.8	26.4	25.6
105							37.6	31.4	28.8	27.2	26.4	24.8	24.4
110							34.8	29.6	27.0	25.6	24.8	23.0	23.2
115							30.4	28.0	25.2	23.8	23.0	21.4	22.0
120								26.6	23.2	21.8	21.2	20.4	20.8
125								25.2	21.4	20.0	19.4	19.4	19.4
130								24.4	20.2	19.0	18.4	18.4	18.0
135									19.2	18.0	17.4	17.4	17.2
140									18.2	17.0	16.4	16.6	16.4
145									17.2	16.0	15.6	15.8	15.6
150									12.8	15.4	14.8	15.0	15.0
155										14.8	14.0	14.2	14.2
160										14.4	13.2	13.4	13.6
165											12.6	12.8	13.0
170											11.8	12.2	12.4
175											11.4	11.6	11.8
180												11.0	11.2
185												10.6	10.6
190												9.6	10.2
195													9.6
200													9.2

* Over the rear with special equipment
 Loads greater than 297,000 lb/335,000 lb can only be lifted with additional special equipment.

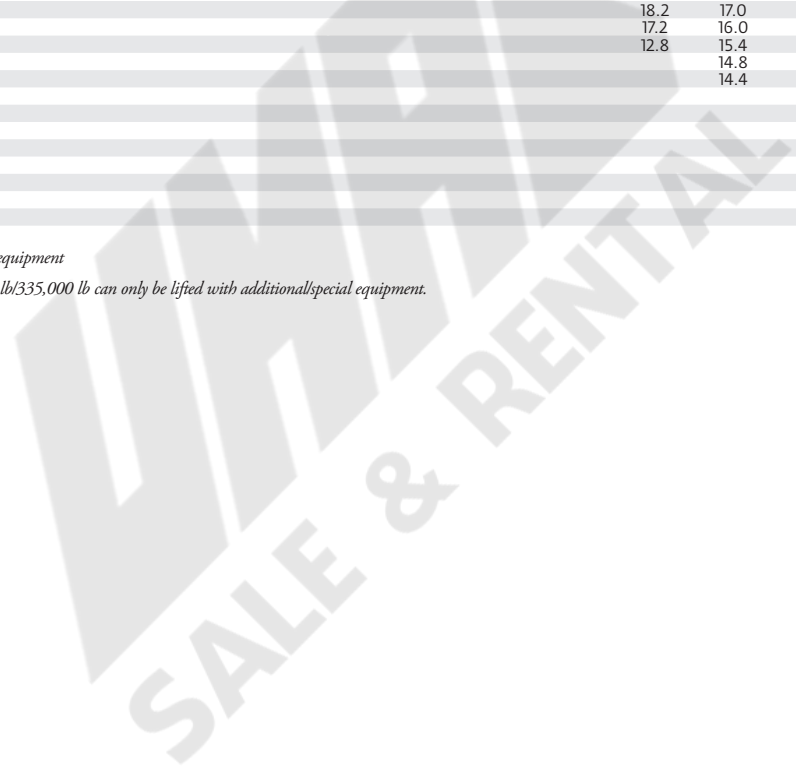

Load charts

Main boom







13,3 m - 68 m
(44 ft - 223 ft)

51 000 kg
(112,400 lb)

26 ft 7 in spread
(100%)

360°



Pounds x 1000

Feet	43.7'	59.1'	74.3'	89.3'	104.2'	119.1'	133.4'	148.8'	164.0'	179.0'	193.9'	208.7'	223.1'
10	336.0	332.0	312.0	244.0									
15	262.0	260.0	258.0	242.0	185.0								
20	210.0	211.0	208.0	210.0	182.0	144.0	106.0						
25	176.0	177.0	176.0	175.0	166.0	140.0	106.0	86.0					
30	149.0	150.0	150.0	148.0	150.0	129.0	105.0	86.0	69.0	55.0	45.0		
35		132.0	130.0	127.0	124.0	118.0	96.0	86.0	69.0	55.0	45.0	36.4	
40		114.0	111.0	110.0	103.0	102.0	88.0	82.0	69.0	55.0	45.0	36.4	30.8
45		98.0	95.0	94.0	90.0	88.0	81.0	75.0	68.0	55.0	45.0	36.4	30.8
50			83.0	82.0	81.0	76.0	76.0	70.0	63.0	55.0	45.0	36.4	30.8
55			72.0	71.0	72.0	67.0	68.0	64.0	59.0	52.0	45.0	36.4	30.8
60				62.0	64.0	62.0	60.0	57.0	54.0	49.0	44.0	36.4	30.8
65				57.0	56.0	58.0	54.0	50.0	49.0	46.0	41.2	36.4	30.8
70				51.0	50.0	52.0	49.0	45.0	43.8	43.2	39.0	36.0	30.8
75				46.0	45.0	47.0	44.0	40.8	39.6	39.0	36.8	34.4	30.8
80					41.6	42.0	40.0	37.0	35.8	35.4	34.8	32.6	30.4
85					39.2	38.2	36.0	34.2	32.4	32.0	32.0	31.0	29.2
90					35.8	34.6	32.6	32.8	29.4	29.2	29.2	29.4	28.0
95						31.4	29.4	31.4	26.8	26.6	26.6	27.4	26.8
100						28.8	26.8	28.6	24.4	24.4	24.4	25.0	25.6
105							25.2	26.0	22.2	22.8	22.2	23.0	23.6
110							24.2	23.8	20.0	21.2	20.4	21.2	21.8
115							23.4	21.8	18.4	20.2	19.0	19.4	20.2
120								20.0	17.8	19.4	18.0	18.6	18.6
125								18.4	17.0	18.4	17.2	17.6	17.2
130								16.8	16.2	17.8	16.4	16.6	15.8
135									15.6	16.8	15.8	15.8	14.6
140									15.0	15.4	15.0	14.8	13.4
145										14.4	14.2	13.6	12.4
150										13.2	13.2	12.6	11.2
155										12.2	12.2	11.4	10.2
160										11.4	11.2	10.6	9.2
165											10.6	9.6	8.4
170											9.8	8.8	7.6
175											9.2	8.0	6.8
180												7.2	6.0
185												6.6	5.2
190												6.0	4.6
195													4.0
200													3.4







13,3 m - 68 m
(44 ft - 223 ft)

41 000 kg
(90,300 lb)

26 ft 7 in spread
(100%)

360°



Pounds x 1000

Feet	43.7'	59.1'	74.3'	89.3'	104.2'	119.1'	133.4'	148.8'	164.0'	179.0'	193.9'	208.7'	223.1'
10	332.0	328.0	312.0	244.0									
15	256.0	256.0	254.0	242.0	185.0								
20	207.0	208.0	206.0	206.0	182.0	144.0	106.0						
25	172.0	173.0	173.0	171.0	166.0	140.0	106.0	86.0					
30	146.0	149.0	146.0	138.0	131.0	128.0	105.0	86.0	69.0	55.0	45.0		
35		124.0	117.0	114.0	110.0	105.0	96.0	86.0	69.0	55.0	45.0	36.4	
40		102.0	101.0	95.0	94.0	88.0	87.0	82.0	69.0	55.0	45.0	36.4	30.8
45		84.0	85.0	81.0	80.0	76.0	75.0	71.0	68.0	55.0	45.0	36.4	30.8
50			72.0	72.0	70.0	70.0	65.0	61.0	59.0	55.0	45.0	36.4	30.8
55			64.0	64.0	61.0	62.0	57.0	54.0	52.0	51.0	45.0	36.4	30.8
60				55.0	56.0	55.0	51.0	47.0	46.0	45.0	44.0	36.4	30.8
65				49.0	51.0	49.0	45.0	42.0	40.6	40.0	39.6	36.4	30.8
70				43.6	45.0	44.0	40.6	39.8	36.2	35.6	35.4	36.0	30.8
75				38.4	40.6	39.4	36.4	37.6	32.4	32.0	31.8	32.4	30.8
80					36.6	35.4	33.0	34.0	29.0	29.4	29.2	30.2	29.8
85					33.0	31.6	30.0	31.0	26.4	28.2	27.8	28.6	27.0
90					29.8	28.6	28.6	28.4	25.0	27.0	26.2	26.6	24.6
95						25.8	27.4	25.6	23.2	25.6	24.6	24.4	22.4
100						23.4	25.2	23.2	21.2	24.0	23.0	22.4	20.4
105							22.8	21.0	20.4	22.2	20.8	20.6	18.6
110							21.0	19.0	19.4	20.4	19.8	18.8	17.0
115							19.2	17.2	18.4	18.6	18.4	17.4	15.6
120								16.0	17.8	17.0	17.0	16.0	14.2
125								15.2	17.0	15.8	16.0	14.6	13.0
130								14.6	15.8	15.0	14.6	13.4	11.8
135									14.6	14.2	13.4	12.2	10.6
140									13.4	13.0	12.2	11.2	9.6
145										12.0	11.2	10.0	8.8
150										11.0	10.2	9.0	7.8
155										10.2	9.2	8.2	7.0
160										9.4	8.4	7.4	6.0
165											7.6	6.6	5.2
170											7.0	5.8	4.6
175											6.2	5.2	3.8
180												4.4	3.2
185												3.8	
190												3.2	

THIS CHART IS ONLY A GUIDE AND SHOULD NOT BE USED TO OPERATE THE CRANE.

Load charts

Main boom





13,3 m - 68 m
(44 ft - 223 ft)

21 000 kg
(46,200 lb)

26 ft 7 in spread
(100%)

360°



 Pounds x 1000

Feet	43.7'	59.1'	74.3'	89.3'	104.2'	119.1'	133.4'	148.8'	164.0'	179.0'	193.9'	208.7'	223.1'
10	320.0	318.0	312.0	244.0									
15	248.0	248.0	246.0	242.0	185.0								
20	199.0	200.0	187.0	175.0	158.0	144.0	106.0						
25	154.0	148.0	138.0	128.0	123.0	113.0	106.0	86.0					
30	114.0	111.0	105.0	103.0	96.0	94.0	87.0	81.0	69.0	55.0	45.0		
35		90.0	87.0	83.0	82.0	77.0	71.0	66.0	63.0	55.0	45.0	36.4	
40		72.0	72.0	68.0	68.0	64.0	59.0	59.0	52.0	51.0	45.0	36.4	30.8
45		58.0	60.0	61.0	58.0	54.0	50.0	51.0	43.8	43.0	42.0	36.4	30.8
50			50.0	52.0	50.0	47.0	45.0	43.4	39.2	40.6	39.6	36.0	30.8
55			45.0	46.0	43.2	40.2	41.2	37.4	36.8	37.4	36.6	34.0	30.8
60				39.2	37.8	36.0	36.0	32.6	34.6	34.0	32.2	29.8	27.4
65				33.8	33.2	33.8	31.8	30.6	31.4	30.2	28.4	26.2	24.0
70				29.4	29.0	30.6	28.2	29.0	28.4	26.8	25.2	23.2	21.0
75				22.8	25.4	27.4	25.0	27.0	25.4	24.0	22.4	20.4	18.4
80					22.2	24.2	23.2	24.4	23.0	21.4	20.0	18.2	16.2
85					22.0	21.4	20.8	22.0	20.6	19.2	17.8	16.0	14.2
90					19.6	19.0	19.4	20.0	18.6	17.2	16.0	14.2	12.4
95						17.4	18.4	18.0	16.8	15.6	14.2	12.6	10.8
100						16.6	16.4	16.2	15.2	14.0	12.6	11.0	9.2
105							14.8	14.6	13.8	12.6	11.2	9.8	8.0
110							13.4	13.0	12.4	11.2	10.0	8.4	6.8
115							12.0	11.6	11.0	10.0	8.8	7.4	5.6
120								10.4	9.8	9.0	7.8	6.4	4.6
125								9.4	8.6	8.0	6.8	5.4	3.8
130								8.4	7.6	7.0	6.0	4.6	2.8
135									6.8	6.0	5.2	3.8	
140									6.0	5.2	4.4	3.0	
145										4.4	3.6		
150										3.6	2.8		
155										3.0			







13,3 m - 68 m
(44 ft - 223 ft)

0 kg
(0 lb)

26 ft 7 in spread
(100%)

360°



 Pounds x 1000

Feet	43.7'	59.1'	74.3'	89.3'	104.2'	119.1'	133.4'	148.8'	164.0'	177.6'	192.6'
10	308.0	308.0	286.0	232.0							
15	222.0	185.0	160.0	144.0	125.0						
20	122.0	114.0	105.0	100.0	90.0	79.0	76.0				
25	81.0	80.0	77.0	72.0	65.0	63.0	57.0	56.0			
30	56.0	58.0	57.0	54.0	53.0	49.0	48.0	45.0	41.2	37.6	34.4
35		44.0	44.0	44.0	42.4	41.2	38.8	36.4	33.4	30.6	28.0
40		34.2	35.6	36.0	35.0	33.8	32.0	30.0	27.6	25.2	22.8
45		27.4	28.8	29.6	29.0	28.0	26.6	25.0	23.0	20.8	18.8
50			23.8	24.8	24.2	23.6	22.4	21.0	19.2	17.2	15.4
55			19.8	20.8	20.4	20.0	19.0	17.8	16.2	14.4	12.8
60				17.6	17.4	17.0	16.2	15.0	13.6	12.0	10.4
65				15.0	14.8	14.6	13.8	12.8	11.4	9.8	8.4
70				12.6	12.6	12.4	11.8	10.8	9.4	8.0	6.8
75				5.8	10.8	10.6	10.0	9.2	7.8	6.6	5.2
80					9.2	9.0	8.4	7.6	6.4	5.2	4.0
85					7.6	7.8	7.2	6.4	5.2	4.0	2.8
90					6.2	6.6	6.0	5.2	4.0	2.8	
95						5.4	4.8	4.2	3.0		
100						4.4	4.0	3.2			
105							3.2				

Working range

223 ft main boom with 39 ft and 69 ft swingaway

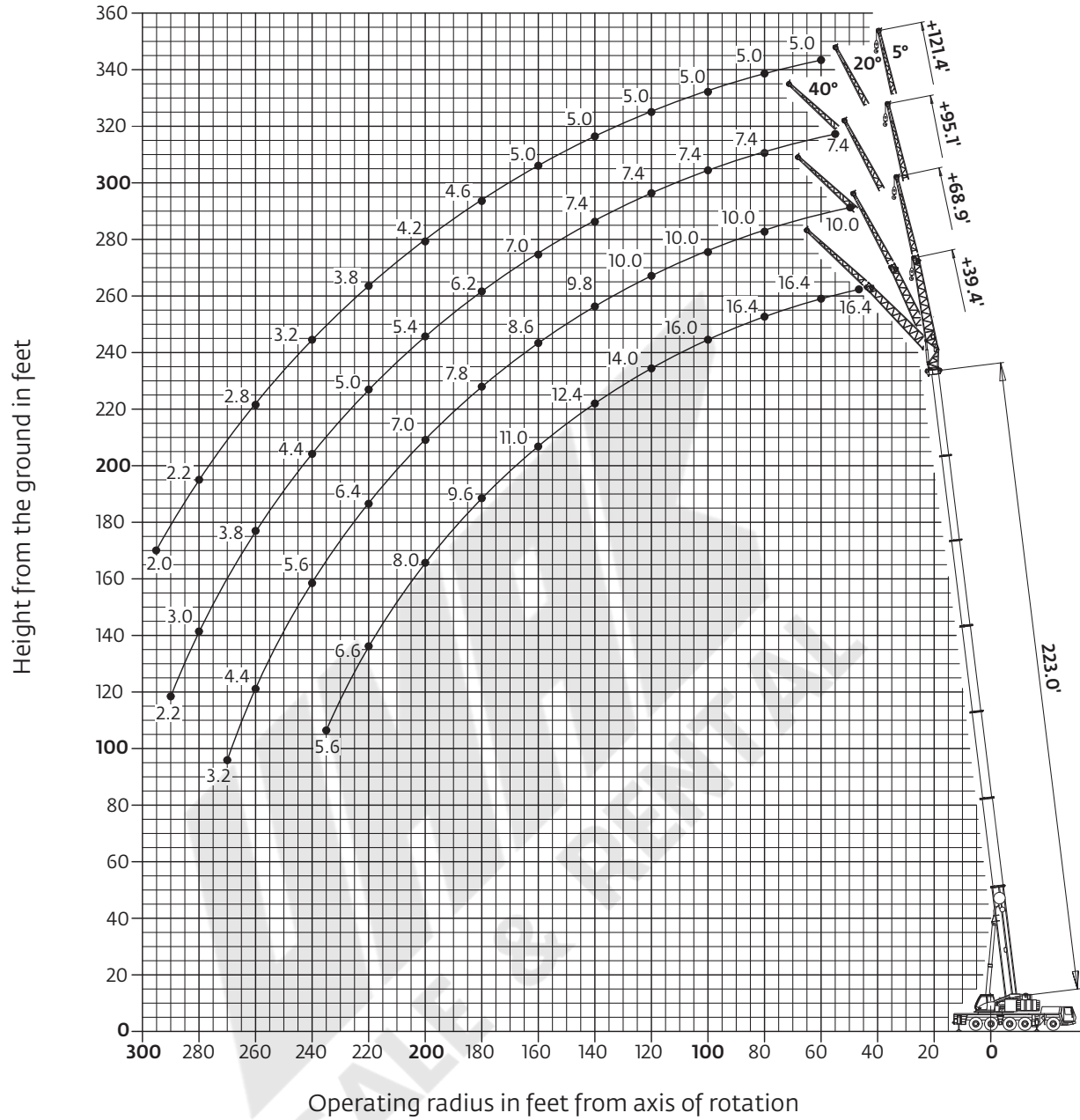

Hook heights shown in the working diagram do not consider loaded boom deflection.

THIS CHART IS ONLY A GUIDE AND SHOULD NOT BE USED TO OPERATE THE CRANE.

Load charts

Hydraulic offsettable swingaway

Intermediate angle and loads for luffing



68 m
(223 ft)



12-21-29-37 m
(39-69-95-121 ft)



77 000 kg
(169,700 lb)



26 ft 7 in spread
(100%)



360°



Pounds x 1000

Radius	223' + 39.4'		223' + 68.9'			223' + 95.1'		223' + 121.4'				
	5°	5° - 20°	20° - 40°	5°	5° - 20°	20° - 40°	5°	5° - 20°	20° - 40°	5°	5° - 20°	20° - 40°
45	16.4											
50	16.4	16.4		10.0								
55	16.4	16.4		10.0		7.4						
60	16.4	16.4	16.4	10.0		7.4			5.0			
65	16.4	16.4	16.4	10.0		7.4			5.0			
70	16.4	16.4	16.4	10.0	10.0	7.4			5.0			
75	16.4	16.4	16.4	10.0	10.0	7.4	7.4		5.0			
80	16.4	16.4	16.4	10.0	10.0	7.4	7.4		5.0	5.0		
85	16.4	16.4	16.0	10.0	10.0	7.4	7.4		5.0	5.0		
90	16.4	16.2	15.6	10.0	10.0	9.4	7.4	7.4	5.0	5.0		
95	16.4	15.8	15.2	10.0	10.0	9.4	7.4	7.4	5.0	5.0	4.0	
100	16.0	15.2	14.8	10.0	10.0	9.2	7.4	7.4	5.0	5.0	4.0	
105	15.6	14.8	14.4	10.0	10.0	9.2	7.4	7.4	5.0	5.0	4.0	
110	15.0	14.4	14.0	10.0	10.0	9.2	7.4	7.4	5.0	5.0	4.0	
115	14.4	13.8	13.6	10.0	10.0	9.0	7.4	7.4	5.0	5.0	4.0	
120	14.0	13.4	13.2	10.0	10.0	9.0	7.4	7.4	5.0	5.0	4.0	
125	13.6	13.0	12.8	10.0	10.0	9.0	7.4	7.4	5.0	5.0	4.0	
130	13.2	12.6	12.4	10.0	9.8	8.8	7.4	7.4	5.0	5.0	4.0	
135	12.8	12.2	12.2	10.0	9.6	8.8	7.4	7.4	5.0	5.0	4.0	
140	12.4	12.0	11.8	9.8	9.4	8.8	7.4	7.2	5.0	5.0	4.0	
145	12.0	11.6	11.4	9.4	9.0	8.6	7.4	7.2	5.0	5.0	4.0	
150	11.6	11.2	11.2	9.2	8.8	8.6	7.4	7.0	6.8	5.0	4.8	4.0
155	11.2	11.0	11.0	9.0	8.6	8.4	7.2	6.8	6.6	5.0	4.8	4.0
160	11.0	10.6	10.6	8.6	8.4	8.2	7.0	6.6	6.6	5.0	4.8	4.0
165	10.6	10.4	10.4	8.4	8.2	8.0	6.8	6.6	6.4	4.8	4.8	4.0
170	10.2	10.2	10.2	8.2	8.0	8.0	6.6	6.4	6.2	4.8	4.6	4.0
175	9.8	9.8	10.0	8.0	7.8	7.8	6.4	6.2	6.2	4.8	4.6	4.0
180	9.6	9.6	9.6	7.8	7.6	7.6	6.2	6.0	6.0	4.6	4.6	4.0
185	9.2	9.2	9.4	7.6	7.4	7.4	6.0	5.8	5.8	4.6	4.4	4.0
190	8.8	8.8	9.0	7.4	7.2	7.2	5.8	5.6	5.8	4.4	4.4	4.0
195	8.2	8.4	8.6	7.2	7.0	7.0	5.6	5.6	5.6	4.2	4.2	4.0
200	8.0	8.0		7.0	6.8	6.8	5.4	5.4	5.4	4.2	4.0	4.0
205	7.6	7.8		6.8	6.6	6.8	5.2	5.2	5.4	4.0	4.0	4.0
210	7.2	7.4		6.6	6.4	6.6	5.0	5.0	5.2	3.8	3.8	4.0
215	6.8	7.0		6.4	6.4	6.4	5.0	5.0	5.0	3.6	3.8	3.8
220	6.4	6.6		6.2	6.2	6.4	4.8	4.8	5.0	3.6	3.6	3.8
225	6.2	6.2		6.0	6.0	6.2	4.6	4.6	4.8	3.4	3.4	3.6
230	5.8	6.0		5.8	6.0		4.6	4.6	4.6	3.2	3.4	3.6
235	5.4	5.6		5.6	5.8		4.4	4.4	4.6	3.2	3.2	3.4
240				5.2	5.6		4.2	4.2	4.4	3.0	3.2	3.2
245				5.0	5.2		4.2	4.2	4.2	3.0	3.0	3.2
250				4.8	5.0		4.0	4.0		2.8	2.8	3.0
255				4.4	4.6		3.8	4.0		2.8	2.8	3.0
260				4.2	4.4		3.8	3.8		2.6	2.6	2.8
265				4.0	4.0		3.6	3.6		2.6	2.6	2.8
270							3.4	3.6		2.4	2.4	
275							3.2	3.4		2.4	2.4	
280							3.0	3.0		2.2	2.2	
285							2.6	2.6		2.2	2.2	
290							2.2	2.2		2.0	2.2	
295										2.0	2.0	

THIS CHART IS ONLY A GUIDE AND SHOULD NOT BE USED TO OPERATE THE CRANE.

The individual crane's load chart, operating instructions and other instructional plates must be read and understood prior to operating the crane.

Load charts

Hydraulic offsettable swingaway

Intermediate angle and loads for luffing

68 m (223 ft)
 12-21-29-37 m (39-69-95-121 ft)
 51 000 kg (112,400 lb)
 26 ft 7 in spread (100%)
 360°

Pounds x 1000

Radius	223' + 39.4'			223' + 68.9'			223' + 95.1'			223' + 121.4'		
	5°	5° - 20°	20° - 40°	5°	5° - 20°	20° - 40°	5°	5° - 20°	20° - 40°	5°	5° - 20°	20° - 40°
45	16.4											
50	16.4	16.4		10.0								
55	16.4	16.4		10.0			7.4					
60	16.4	16.4	16.4	10.0			7.4			5.0		
65	16.4	16.4	16.4	10.0			7.4			5.0		
70	16.4	16.4	16.4	10.0	10.0		7.4			5.0		
75	16.4	16.4	16.4	10.0	10.0		7.4	7.4		5.0		
80	16.4	16.4	16.4	10.0	10.0		7.4	7.4		5.0	5.0	
85	16.4	16.4	16.0	10.0	10.0		7.4	7.4		5.0	5.0	
90	16.4	16.2	15.6	10.0	10.0	9.4	7.4	7.4		5.0	5.0	
95	16.4	15.8	15.2	10.0	10.0	9.4	7.4	7.4	7.2	5.0	5.0	4.0
100	16.0	15.2	14.8	10.0	10.0	9.2	7.4	7.4	7.2	5.0	5.0	4.0
105	15.6	14.8	14.4	10.0	10.0	9.2	7.4	7.4	7.2	5.0	5.0	4.0
110	15.0	14.4	14.0	10.0	10.0	9.2	7.4	7.4	7.2	5.0	5.0	4.0
115	14.4	13.8	13.6	10.0	10.0	9.0	7.4	7.4	7.2	5.0	5.0	4.0
120	14.0	13.4	13.2	10.0	10.0	9.0	7.4	7.4	7.2	5.0	5.0	4.0
125	13.6	13.0	12.8	10.0	10.0	9.0	7.4	7.4	7.2	5.0	5.0	4.0
130	13.2	12.6	12.4	10.0	9.8	8.8	7.4	7.4	7.2	5.0	5.0	4.0
135	12.8	12.2	12.2	10.0	9.6	8.8	7.4	7.4	7.2	5.0	5.0	4.0
140	12.4	12.0	11.8	9.8	9.4	8.8	7.4	7.2	7.0	5.0	5.0	4.0
145	12.0	11.6	11.4	9.4	9.0	8.6	7.4	7.2	7.0	5.0	5.0	4.0
150	11.2	11.2	11.2	9.2	8.8	8.6	7.4	7.0	6.8	5.0	4.8	4.0
155	10.2	10.2	10.8	9.0	8.6	8.4	7.2	6.8	6.6	5.0	4.8	4.0
160	9.4	9.4	10.0	8.6	8.4	8.2	7.0	6.6	6.6	5.0	4.8	4.0
165	8.6	8.6	9.2	8.4	8.2	8.0	6.8	6.6	6.4	4.8	4.8	4.0
170	7.8	7.8	8.4	8.2	8.0	8.0	6.6	6.4	6.2	4.8	4.6	4.0
175	7.0	7.0	7.6	8.0	7.8	7.8	6.4	6.2	6.2	4.8	4.6	4.0
180	6.4	6.4	6.8	7.2	7.2	7.6	6.2	6.0	6.0	4.6	4.6	4.0
185	5.6	5.6	6.0	6.6	6.6	7.4	6.0	5.8	5.8	4.6	4.4	4.0
190	5.0	5.0	5.4	6.0	6.0	6.8	5.8	5.6	5.8	4.4	4.4	4.0
195	4.4	4.4	4.8	5.4	5.4	6.2	5.4	5.4	5.6	4.2	4.2	4.0
200	3.8	3.8		4.8	4.8	5.6	4.8	4.8	5.4	4.2	4.0	4.0
205	3.2	3.2		4.4	4.4	5.0	4.2	4.2	5.0	4.0	4.0	4.0
210	2.6	2.6		3.8	3.8	4.4	3.8	3.8	4.4	3.6	3.6	4.0
215	2.2	2.2		3.2	3.2	3.8	3.2	3.2	4.0	3.2	3.2	3.8
220				2.8	2.8	3.4	2.8	2.8	3.4	2.6	2.6	3.4
225				2.2	2.2	2.8	2.4	2.4	3.0	2.2	2.2	3.0
230							2.0	2.0	2.6			2.4
235									2.2			2.0



Load charts

Hydraulic offsettable swingaway

Intermediate angle and loads for luffing

68 m
(223 ft)

12-21-29-37 m
(39-69-95-121 ft)

41 000 kg
(90,300 lb)

26 ft 7 in spread
(100%)

360°



Pounds (thousands)

Radius	223' + 39.4'			223' + 68.9'			223' + 95.1'			223' + 121.4'		
	5°	5° - 20°	20° - 40°	5°	5° - 20°	20° - 40°	5°	5° - 20°	20° - 40°	5°	5° - 20°	20° - 40°
45	16.4											
50	16.4	16.4		10.0								
55	16.4	16.4		10.0			7.4					
60	16.4	16.4	16.4	10.0			7.4			5.0		
65	16.4	16.4	16.4	10.0			7.4			5.0		
70	16.4	16.4	16.4	10.0	10.0		7.4			5.0		
75	16.4	16.4	16.4	10.0	10.0		7.4	7.4		5.0		
80	16.4	16.4	16.4	10.0	10.0		7.4	7.4		5.0	5.0	
85	16.4	16.4	16.0	10.0	10.0		7.4	7.4		5.0	5.0	
90	16.4	16.2	15.6	10.0	10.0	9.4	7.4	7.4		5.0	5.0	
95	16.4	15.8	15.2	10.0	10.0	9.4	7.4	7.4	7.2	5.0	5.0	4.0
100	16.0	15.2	14.8	10.0	10.0	9.2	7.4	7.4	7.2	5.0	5.0	4.0
105	15.6	14.8	14.4	10.0	10.0	9.2	7.4	7.4	7.2	5.0	5.0	4.0
110	15.0	14.4	14.0	10.0	10.0	9.2	7.4	7.4	7.2	5.0	5.0	4.0
115	14.4	13.8	13.6	10.0	10.0	9.0	7.4	7.4	7.2	5.0	5.0	4.0
120	13.8	13.4	13.2	10.0	10.0	9.0	7.4	7.4	7.2	5.0	5.0	4.0
125	12.6	12.6	12.8	10.0	10.0	9.0	7.4	7.4	7.2	5.0	5.0	4.0
130	11.6	11.6	12.4	10.0	9.8	8.8	7.4	7.4	7.2	5.0	5.0	4.0
135	10.4	10.4	11.2	10.0	9.6	8.8	7.4	7.4	7.2	5.0	5.0	4.0
140	9.4	9.4	10.2	9.8	9.4	8.8	7.4	7.2	7.0	5.0	5.0	4.0
145	8.6	8.6	9.2	9.4	9.0	8.6	7.4	7.2	7.0	5.0	5.0	4.0
150	7.6	7.6	8.4	8.6	8.6	8.6	7.4	7.0	6.8	5.0	4.8	4.0
155	6.8	6.8	7.4	7.8	7.8	8.4	7.2	6.8	6.6	5.0	4.8	4.0
160	6.0	6.0	6.6	7.0	7.0	8.2	6.8	6.6	6.6	5.0	4.8	4.0
165	5.4	5.4	6.0	6.2	6.2	7.4	6.2	6.2	6.4	4.8	4.8	4.0
170	4.8	4.8	5.2	5.6	5.6	6.6	5.4	5.4	6.2	4.8	4.6	4.0
175	4.0	4.0	4.6	5.0	5.0	6.0	4.8	4.8	6.0	4.6	4.6	4.0
180	3.4	3.4	4.0	4.4	4.4	5.4	4.2	4.2	5.2	4.0	4.0	4.0
185	2.8	2.8	3.4	3.8	3.8	4.6	3.6	3.6	4.6	3.6	3.6	4.0
190	2.4	2.4	2.8	3.2	3.2	4.0	3.2	3.2	4.0	3.0	3.0	4.0
195			2.2	2.8	2.8	3.6	2.6	2.6	3.6	2.6	2.6	3.4
200				2.2	2.2	3.0	2.2	2.2	3.0	2.0	2.0	2.8
205						2.4			2.4			2.4
210						2.0			2.0			2.0

WINDY SALE & RENTALS

THIS CHART IS ONLY A GUIDE AND SHOULD NOT BE USED TO OPERATE THE CRANE.

The individual crane's load chart, operating instructions and other instructional plates must be read and understood prior to operating the crane.

Working range

Heavy duty jib 6.6 ft

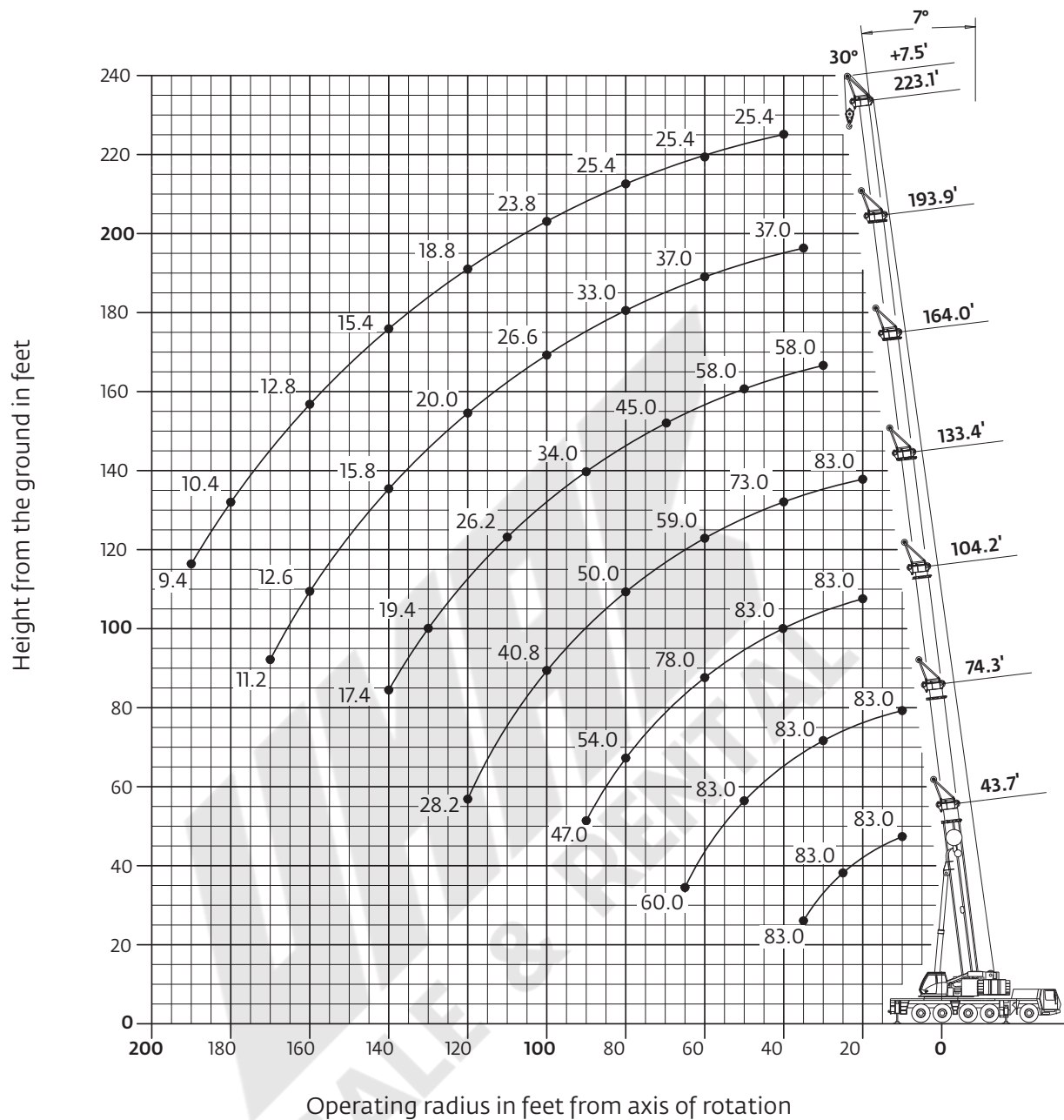

Hook heights shown in the working diagram do not consider loaded boom deflection.

THIS CHART IS ONLY A GUIDE AND SHOULD NOT BE USED TO OPERATE THE CRANE.

Grove GMK5275 The individual crane's load chart, operating instructions and other instructional plates must be read and understood prior to operating the crane.

Load charts

Heavy duty jib

Fixed angle

 13,3 m-68 m
(44 ft-223 ft)

 2,3 m
(7.5 ft)

 77 000 kg
(169,700 lb)

 26 ft 7 in spread
(100%)

 360°



Pounds (thousands)

Radius	43.7' + 7.5'		74.3' + 7.5'		104.2' + 7.5'		133.4' + 7.5'		164.0' + 7.5'		193.9' + 7.5'		223.1' + 7.5'	
	8°	30°	8°	30°	8°	30°	8°	30°	8°	30°	8°	30°	8°	30°
10.0		83.0		83.0										
15.0		83.0		83.0										
20.0		83.0		83.0										
25.0		83.0		83.0		83.0		83.0						
30.0	83.0	83.0		83.0		83.0		81.0		58.0				
35.0	83.0	83.0		83.0		83.0		77.0		58.0		37.0		
40.0				83.0		83.0		73.0		58.0		37.0		25.4
45.0				83.0		83.0		69.0		58.0		37.0		25.4
50.0			83.0	83.0		83.0		65.0		58.0		37.0		25.4
55.0			83.0	83.0		83.0		62.0		55.0		37.0		25.4
60.0			74.0			78.0		59.0		52.0		37.0		25.4
65.0			60.0			71.0		57.0		49.0		37.0		25.4
70.0						65.0		54.0		45.0		36.6		25.4
75.0						59.0	59.0	52.0		42.2		34.8		25.4
80.0						54.0	54.0	50.0		38.8		33.0		25.4
85.0						51.0	51.0	47.0		36.2		31.2		25.4
90.0						45.0	47.0	46.0		34.0		29.8		25.4
95.0								44.0	43.4	31.8		28.2		24.6
100.0								40.6	40.8	29.6		26.6		23.8
105.0								37.4	37.6	27.8		24.8		22.4
110.0								34.4	34.6	26.2		23.0		21.0
115.0								31.8	32.0	24.6		21.2		19.6
120.0								28.2		22.6		20.0		18.8
125.0										20.6		18.8		17.8
130.0										19.4		17.8		17.0
135.0										18.4		16.8		16.2
140.0										17.4		15.8		15.4
145.0												15.0		14.6
150.0												14.0		14.0
155.0												13.4		13.4
160.0												12.6		12.8
165.0												11.8		12.2
170.0												11.2		11.6
175.0														11.0
180.0														10.4
185.0														10.0
190.0														9.4

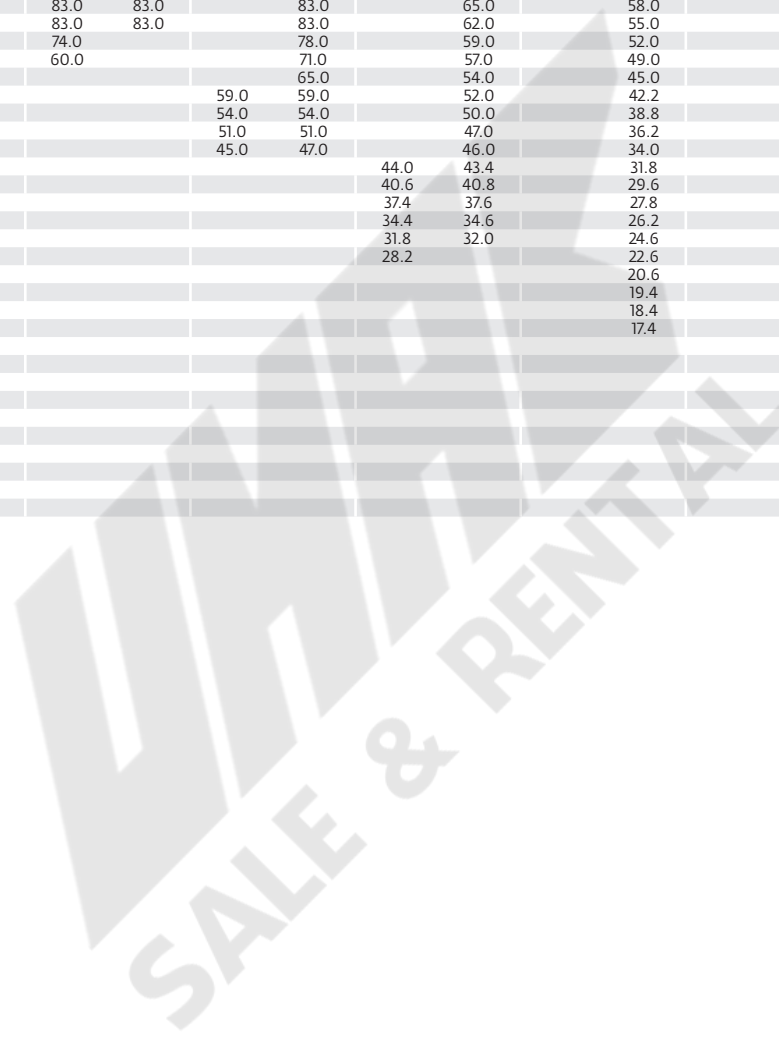

THIS CHART IS ONLY A GUIDE AND SHOULD NOT BE USED TO OPERATE THE CRANE.



The individual crane's load chart, operating instructions and other instructional plates must be read and understood prior to operating the crane.

Load charts

Heavy duty jib

Fixed angle

 13,3 m-68 m (44 ft-223 ft)
  2,3 m (7.5 ft)
  51 000 kg (112,400 lb)
  26 ft 7 in spread (100%)
  360°

  Pounds (thousands)



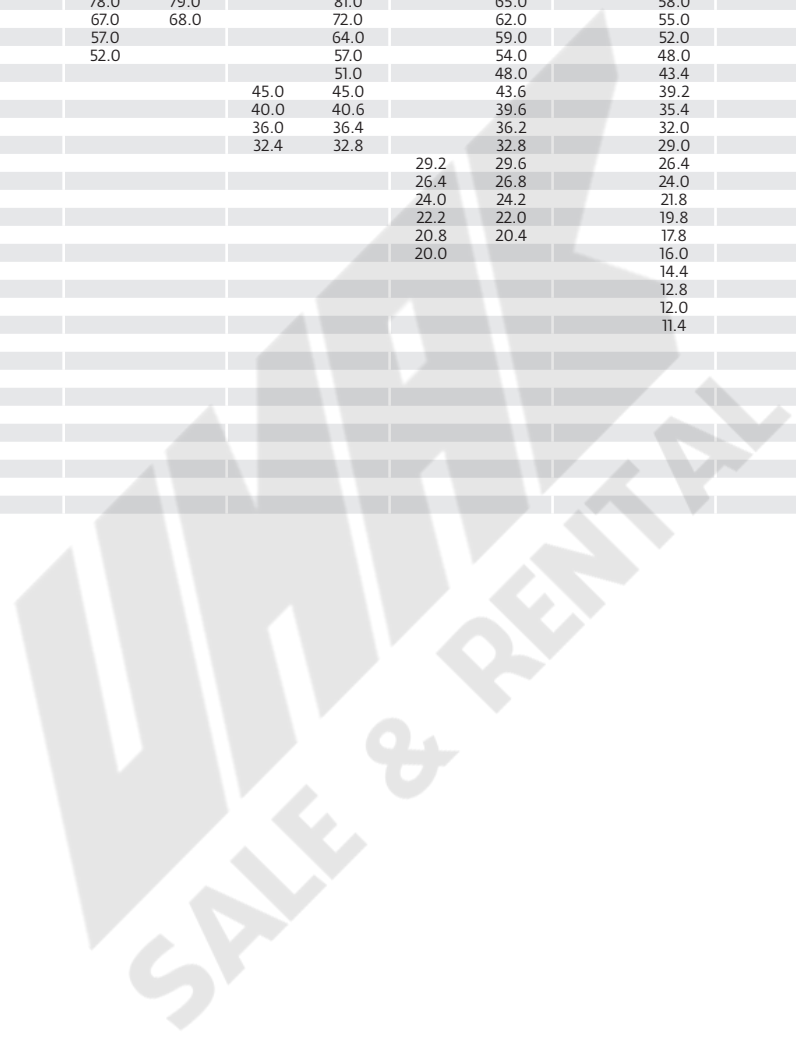





























Radius	43.7' + 7.5'		74.3' + 7.5'		104.2' + 7.5'		133.4' + 7.5'		164.0' + 7.5'		193.9' + 7.5'		223.1' + 7.5'	
	8°	30°	8°	30°	8°	30°	8°	30°	8°	30°	8°	30°	8°	30°
10.0		83.0		83.0										
15.0		83.0		83.0										
20.0		83.0		83.0		83.0		83.0						
25.0		83.0		83.0		83.0		83.0						
30.0	83.0	83.0		83.0		83.0		81.0		58.0				
35.0	83.0	83.0		83.0		83.0		77.0		58.0				
40.0				83.0		83.0		73.0		58.0		37.0		25.4
45.0				83.0		83.0		69.0		58.0		37.0		25.4
50.0			78.0	79.0		81.0		65.0		58.0		37.0		25.4
55.0			67.0	68.0		72.0		62.0		55.0		37.0		25.4
60.0			57.0			64.0		59.0		52.0		37.0		25.4
65.0			52.0			57.0		54.0		48.0		37.0		25.4
70.0						51.0		48.0		43.4		36.6		25.4
75.0					45.0	45.0		43.6		39.2		34.8		25.4
80.0					40.0	40.6		39.6		35.4		33.0		25.4
85.0					36.0	36.4		36.2		32.0		31.2		25.4
90.0					32.4	32.8		32.8		29.0		28.8		25.4
95.0							29.2	29.6		26.4		26.2		24.6
100.0							26.4	26.8		24.0		23.8		23.8
105.0							24.0	24.2		21.8		21.8		22.4
110.0							22.2	22.0		19.8		19.8		20.8
115.0							20.8	20.4		17.8		18.2		19.2
120.0							20.0			16.0		17.0		17.6
125.0										14.4		16.2		16.2
130.0										12.8		15.4		14.8
135.0										12.0		14.6		13.6
140.0										11.4		14.0		12.6
145.0												13.4		11.4
150.0												12.4		10.4
155.0												11.4		9.4
160.0												10.4		8.4
165.0												9.8		7.6
170.0												9.0		6.8
175.0														6.0
180.0														5.2
185.0														4.4
190.0														3.8



THIS CHART IS ONLY A GUIDE AND SHOULD NOT BE USED TO OPERATE THE CRANE.

The individual crane's load chart, operating instructions and other instructional plates must be read and understood prior to operating the crane.

Symbols glossary

 Axles	 Counterweight	 Grade	 Gear
 Boom	 Drive	 Heavy duty jib	 Radius
 Boom elevation	 Electrical system	 Hoist	 Rotation
 Boom extension	 Engine	 Hookblock	 Speed
 Boom length	 Extension	 Hydraulic system	 Steering
 Boom nose	 Frame	 Lights	 Suspension
 Brakes	 Fuel tank capacity	 Oil	 Swing
 Cab	 Outriggers	 Outrigger controls	 Tires
			 Transmission

UMAX
SALE & RENTAL

Regional headquarters

Manitowoc - Americas

Manitowoc, Wisconsin, USA

Tel: +1 920 684 6621

Fax: +1 920 683 6277

Shady Grove, Pennsylvania, USA

Tel: +1 717 597 8121

Fax: +1 717 597 4062

Manitowoc - Europe, Middle East & Africa

Ecully, France

Tel: +33 (0)4 72 18 20 20

Fax: +33 (0)4 72 18 20 00

Manitowoc - Asia Pacific

Shanghai, China

Tel: +86 21 6457 0066

Fax: +86 21 6457 4955

Regional offices

Americas

Brazil

Alphaville

Mexico

Monterrey

Chile

Santiago

Europe, Middle East & Africa

Czech Republic

Netvorice

France

Baudemont

Cergy

Decines

Germany

Langenfeld

Hungary

Budapest

Italy

Parabiago

Netherlands

Breda

Poland

Warsaw

Portugal

Baltar

Russia

Moscow

U.A.E.

Dubai

U.K.

Gawcott

Asia - Pacific

Australia

Brisbane

Melbourne

Sydney

China

Beijing

Xi'an

India

Hyderabad

Pune

Korea

Seoul

Philippines

Makati City

Singapore

Factories

Brazil

Alphaville

China

TaiAn

Zhangjiagang

France

Charlieu

La Clayette

Moulins

Germany

Wilhelmshaven

India

Pune

Italy

Niella Tanaro

Portugal

Baltar

Fânzeres

Slovakia

Saris

USA

Manitowoc

Port Washington

Shady Grove

This document is non-contractual. Constant improvement and engineering progress make it necessary that we reserve the right to make specification, equipment, and price changes without notice. Illustrations shown may include optional equipment and accessories and may not include all standard equipment.