

Grove GMK5225 Tier 4i

Product Guide

ASME B30.5
Imperial 85%



Features

- 170 t (225 USt) capacity
- 13,7 m - 64 m (45 ft - 210 ft) six-section full power MEGAFORM™ boom with TWIN-LOCK™ pinning
- Chassis engine: Mercedes-Benz OM 502 LA, eight-cylinder, 405 kW (543 hp)
- Superstructure engine: Mercedes-Benz OM 924 LA, four-cylinder, 150 kW (201 hp)
- Allison 4000 SP transmission

Features

MEGATRAK™

The MEGATRAK™ suspension system is the best off road driveline available on the market today. The system's versatility and performance allows the GMK5225 Tier 4i to operate as a true all-terrain crane. The MEGATRAK™ independent suspension and all-wheel steer system allows wheels to remain on the ground at all times so stresses and weight are not continually transferred between axles. MEGATRAK™ provides true ground clearance where others just raise the chassis.

Other benefits of the MEGATRAK™ system are:

- A reliable suspension system
- Excellent job site maneuverability with all-wheel steering
- Commonality among almost all models
- A driveline that remains aligned at all times
- A steering linkage system that is protected against damage
- Constant tire contact for equal tire wear
- Reduced maintenance



TWIN-LOCK™

Boom pinning mechanism automatically pins the sections in position using two horizontal pins.

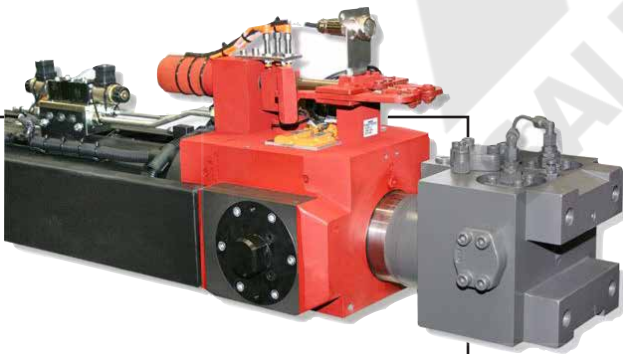

CraneSTAR

CraneSTAR is an exclusive and innovative crane asset management system that helps improve your profitability and reduce costs by remotely monitoring critical crane data. Visit www.cranestar.com for more information.

EKS 5

The EKS 5 monitors the lifting conditions of the crane at all times and provides a full graphic display, rear lighting, graphic of boom telescoping percentage, and load charts.

ECOS

Electronic Crane Operating System - ECOS enables control of the entire crane's principle operations. Simple programming eases lift planning and a supply of essential information allows full concentration on the lift itself.



Contents

Specifications	4
Dimensions	7
Weight proposals	8
Counterweight	9
Working range (main boom)	10
Load charts (main boom)	11
Working range (swingaway and inserts)	15
Load charts (hydraulic offsettable swingaway)	16
Working range (heavy duty jib)	18
Load charts (heavy duty jib)	19
Symbols glossary	21

Specifications

Superstructure



Boom

13,7 m - 64 m (45 ft - 210 ft) six-section, full power MEGAFORM™ boom with patented TWIN-LOCK™ boom pinning system.

Maximum tip height: 67 m (220 ft).



Boom nose

Seven nylatron sheaves, mounted on heavy duty tapered roller bearings with removable pin-type rope guards. Quick reeve boom nose. Removable auxiliary boom nose with removable pin type rope guard.



Boom elevation

Single lift cylinder with safety valve provides boom angle from -1.5° to +83°.



Hydraulic offsettable lattice extension

11 m - 18 m (36 ft - 59 ft) bi-fold lattice swingaway extension hydraulically offsettable and luffing under load: 0° - 40°.

Controlled from the crane cab.

Maximum tip height: 85 m (279 ft)



*Manual offsettable lattice extension

11 m - 18 m (36 ft - 59 ft) bi-fold lattice swingaway extension manually offsettable 0°, 20° or 40°. Maximum tip height: 85 m (279 ft)



Lattice inserts

2 x 8 m (26 ft) inserts for use with lattice swingaway extension to increase length to 26 m (85 ft) or 34 m (112 ft).

Maximum tip height: 101 m (331 ft)



Load moment and anti-two block system

Load moment and anti-two block system with audio/visual warning and control lever lockout provides electronic display of boom angle, length, radius, tip height, relative load moment, maximum permissible load, load indication and warning of impending two-block condition.



Cab

All aluminum constructed cab with acoustical lining, hydraulic tilted to 20°. Includes tinted safety glass, adjustable operator's seat, opening windows at side and rear, hinged windshield with wiper, sun visor and window shade. Other features include, engine-dependent hot water heater/defroster, armrest integrated crane controls, and ergonomically arranged instrumentation.



Swing

Three planetary gear boxes with fixed displacement axial piston motors. Infinitely variable to 1.3 rpm. Free swing or hydrostatically engaged brake controlled by swing lever. Swing brake selected by foot operated switch.



Counterweight

52,0 t (114,600 lb) consisting of various sections with hydraulic installation/removal system. Controlled from the superstructure cab.



Engine - Mercedes-Benz

Mercedes-Benz OM924LA, diesel, 4-cylinders, water cooled, turbocharged 150 kW (201 HP) at 2200 rpm (80/1269 EWG - fan rigid). Max torque: 800 Nm (590 ft lb) at 1200 rpm. Fuel tank capacity: integrated in carrier fuel reservoir.

Engine transmission: Tier 4i / EPA / CARB (non-road).



Fuel tank capacity

Fuel tank integrated in carrier chassis.



Electrical system

3 phase alternator: 28V/80A

2 batteries: 12V/170Ah



Hydraulic system

2 separate circuits, 1 axial piston variable displacement pump (load sensing) with electronic power limiting control and 1 double gear pump for slewing. Thermostatically controlled oil coolers keep oil at optimum operating temperature. Hydraulic tank capacity: 870L (230 gal)



Hoist

Main and auxiliary hoists are powered by axial piston motor with planetary gear and brake. "Thumb-thumper" hoist drum rotation indicator alerts operator of hoist movement. Camera system for main and auxiliary hoist. Wire rope with swatched end rope sockets.

	Main	Auxiliary
Rope length:	290 m (951 ft)	290 m (951 ft)
Rope diameter:	22 mm	22 mm
Line speed:	125 m/min (410 fpm)	125 m/min (410 fpm)
Line pull:	93.0 kN (20,907 lb)	93.0 kN (20,907 lb)

Specifications

Superstructure continued

*Optional hook blocks

Lifting capacity	Sheaves	Weight	Parts of line	Possible load with the crane
200 t (220 USt)	9	2400 kg (5291 lb)	2-16	140 t* (154 USt*)
160 t (176 USt)	7	1750 kg (3858 lb)	2-15	135 t (182 USt)
125 t (138 USt)	5	1650 kg (3638 lb)	2-11	100 t (110 USt)
80 t (88 USt)	3	950 kg (2094 lb)	1-7	65 t (72 USt)
32 t** (35 USt)	1	600 kg (1323 lb)	1-3	28 t (31 USt)
12 t*** (13.2 USt)	H/B	300 kg (661 lb)	1	9,5 t (10.5 USt)

* Requires additional boom nose sheave

** Required for overhaul of single part line with boom/jib lengths in excess of 64 m (210 ft)

*** Overhaul weight designed for a maximum of 64 m (210 ft) boom/jib lengths

*Optional equipment

- ▶ 3,6 m (11.8 ft) side-stowed 3-sheave integrated heavy duty jib
- ▶ Work lights, mounted on boom base section
- ▶ Radio/CD player for superstructure cab
- ▶ Stainless steel exhaust system with spark arrestor
- ▶ Air conditioning
- ▶ Hook blocks/headache ball
- ▶ Engine independent diesel cab heater, with engine pre-heater including 24-hour timer
- ▶ Engine independent propane gas cab heater
- ▶ Additional cab mounted work light
- ▶ Strobe light
- ▶ Working range limiter
- ▶ Data logger
- ▶ Camera system for boom head
- ▶ EKS5 Light with semi-graphic display

Carrier



Chassis

Box type, torsion resistant frame is fabricated from high strength steel.



Outrigger system

Four hydraulic two-stage outrigger beams with vertical cylinders and outrigger pads, 600 mm (23.6 in) square. Outriggers can be set in five positions:

Full:	8,1 m (26.6 ft)
75%:	6,8 m (22.4 ft)
50%:	5,6 m (18.4 ft)
25%:	4,4 m (14.4 ft)
Retracted:	2,8 m (9.0 ft)

Independent horizontal and vertical movement controlled from each side of carrier and from the operator's cab. Electronic crane level indicator with automatic leveling system. Includes outrigger monitoring system.



Transmission

Allison 4000 SP. 6 speeds forward, 1 reverse
2 speed transfer case



Drive/steer

10x6x10



Tires

10 tires, 445/95 R 25 (16.00 R25)
(vehicle width - 3,0 m [9.8 ft])



Axles

- 1st axle line – steer
- 2nd axle line – steer (optional drive)
- 3rd axle line – drive/steer (permanent drive with 10x6, disconnects for highway with 10x8))
- 4th axle line – drive/steer (connects for all wheel steer)
- 5th axle line – drive/steer

Drive axles with planetary hub reduction and center mounted differential-gearing. Inter-axle and cross axle differential locks.



Suspension

Grove exclusive MEGATRAK™ suspension. Independent hydro-pneumatic system acting on all wheels with hydraulic lockout. Suspension can be raised 160 mm (6.3 in) or lowered 120 mm (4.7 in) both longitudinally and transversely. Features an automatic leveling system for highway travel.

Specifications

Carrier continued



Steering

Dual circuit, hydraulic power assisted steering system. Transfer case mounted, ground driven emergency steering pump. Axles 1, 2, 3 and 5 steer on highway (steer by wire). Separate steering of the 4th and 5th axles for all wheel and crab steering, controlled by an electronic rocker switch.



Engine - Mercedes-Benz

Mercedes-Benz OM 502LA, diesel, 8-cylinders, water cooled, turbocharged, 405 kW (543 HP) at 1800 rpm (80/1269 fan loose). Max. torque: 2600 Nm (1918 ft lb) at 1300 rpm. Fuel tank capacity: 515 L (136 gal).

Engine transmission: Tier 4i / EPA / CARB (non-road).



Fuel tank capacity

580 L (143 gal) also serves superstructure engine



Brakes

Service brakes: dual line pneumatic disc brakes on all wheels.

Parking brake: pneumatically operated spring loaded brake acting on axle lines 2,3,4 and 5.



Cab

Two-man aluminum construction with the following features: safety glass, driver seat with pneumatic suspension, engine-dependent hot water heater, heated rear view mirrors, complete instrumentation and driving controls.



Electrical system

24V system with three phase alternator, 28V/100A
2 batteries, 12V/170 Ah



Maximum speed

85 km/h (53 mph)



Gradeability (theoretical)

50% - 14.00 tires
45% - 16.00 / 20.5 tires

Miscellaneous standard equipment

Work light, tool kit; fire extinguishers; auxiliary boom nose, radio/CD player in carrier cab, heated rear view mirrors, wind speed indicator, working light for each outrigger beam, CraneSTAR asset management system.

*Optional equipment

- ▶ Stainless steel exhaust system with spark arrestor
- ▶ Air conditioning
- ▶ 385/95 R25 tires (14.00 R25) (vehicle width 3,0 m [9.8 ft])
- ▶ 525/80 R25 tires (20.5 R25) (vehicle width 3,1 m [10.2 ft])
- ▶ 10x8x10 drive/steer
- ▶ Transmission retarder (in lieu of engine compression brake)
- ▶ Engine independent diesel cab heater, with engine pre-heater, including 24 hour timer
- ▶ Engine independent propane gas cab heater
- ▶ Engine shutdown valve (for both engines)
- ▶ Reversing camera system
- ▶ Wireless remote control
- ▶ Rear mounted stowage box
- ▶ Outrigger pad load indicator
- ▶ Trailer hitch
- ▶ Steel outrigger pads
- ▶ Strobe light
- ▶ Spare tire

Dimensions

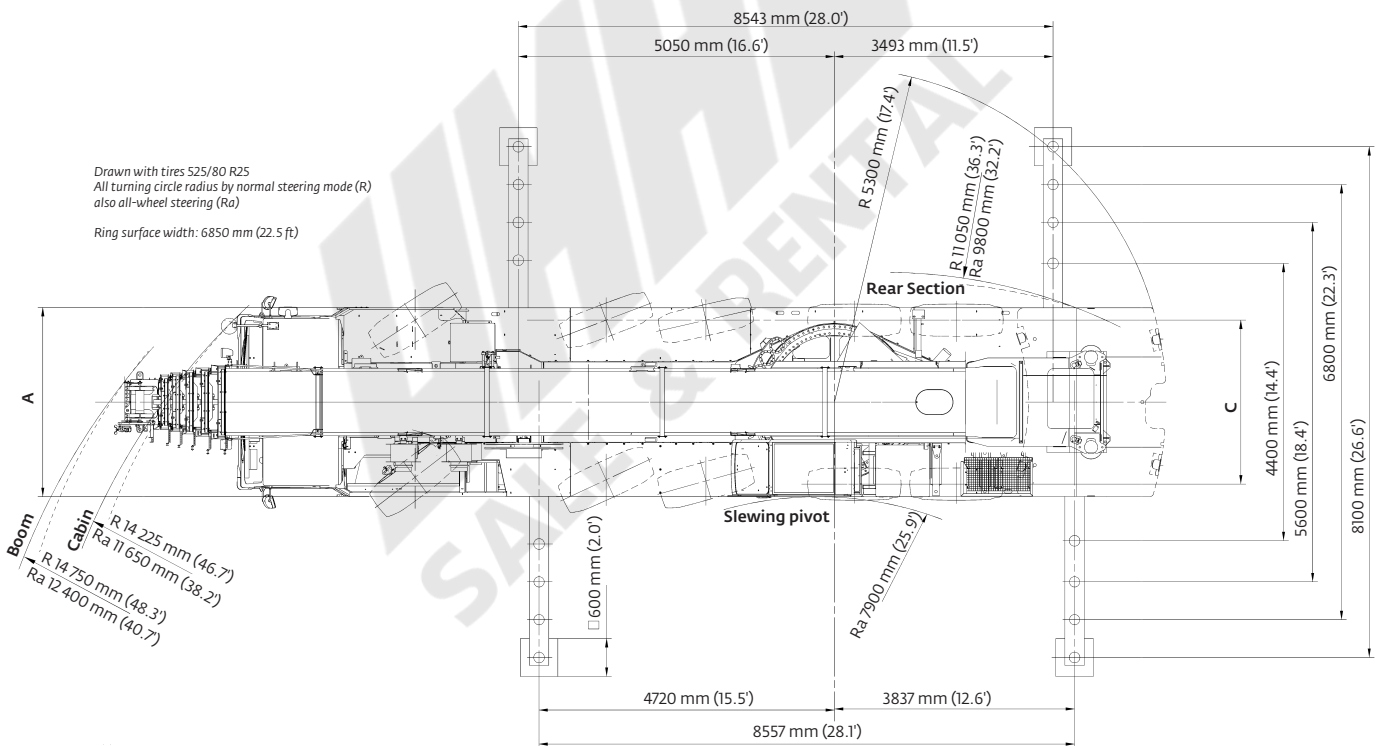
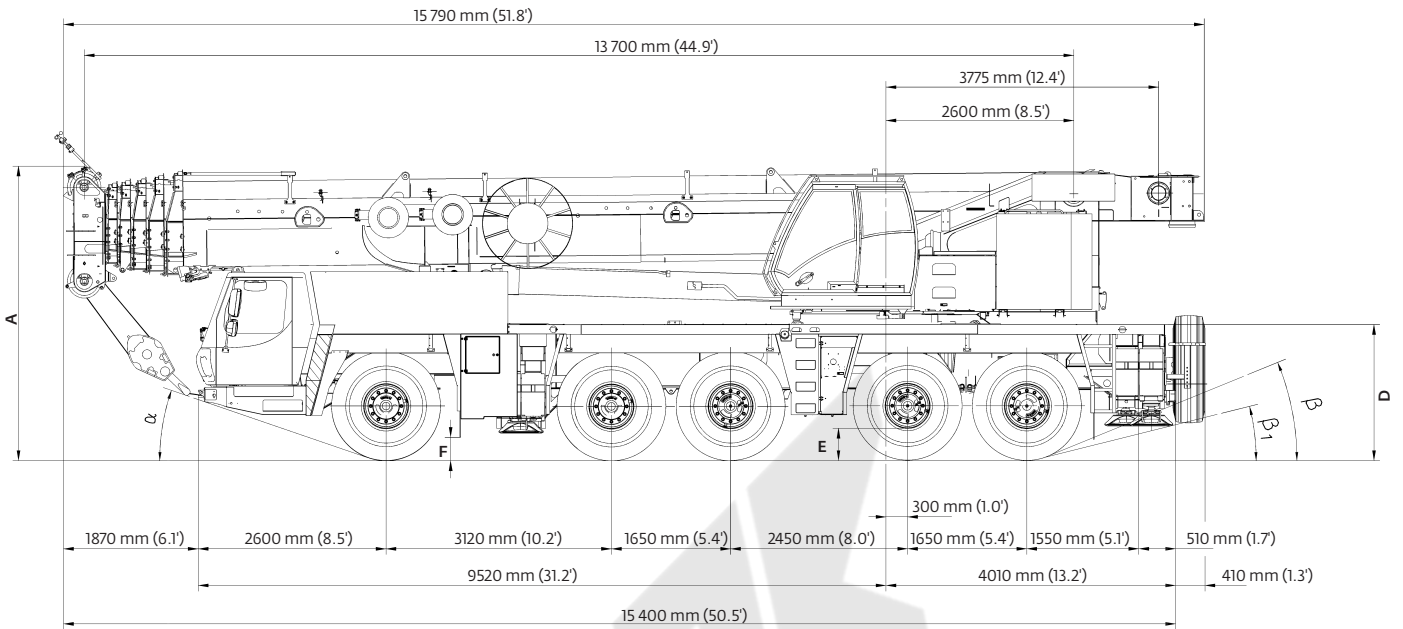

Tires	A	A*	B	C	D	E	F	α	β	β_1
14.00 R25	3950 mm (13.0 ft)	3820 mm (12.5 ft)	2970 mm (9.7 ft)	2570 mm (8.4 ft)	1825 mm (6.0 ft)	435 mm (1.4 ft)	295 mm (1.0 ft)	17°	20°	12°
16.00 R25	4000 mm (13.1 ft)	3870 mm (12.7 ft)	3000 mm (9.8 ft)	2510 mm (8.2 ft)	1875 mm (6.2 ft)	485 mm (1.6 ft)	325 mm (1.1 ft)	19°	22°	14°
20.5 R25	4000 mm (13.1 ft)	3870 mm (12.7 ft)	3100 mm (10.2 ft)	2530 mm (8.3 ft)	1875 mm (6.2 ft)	485 mm (1.6 ft)	325 mm (1.1 ft)	19°	22°	14°

* lowered 130 mm (0.4 ft)

Weight proposals

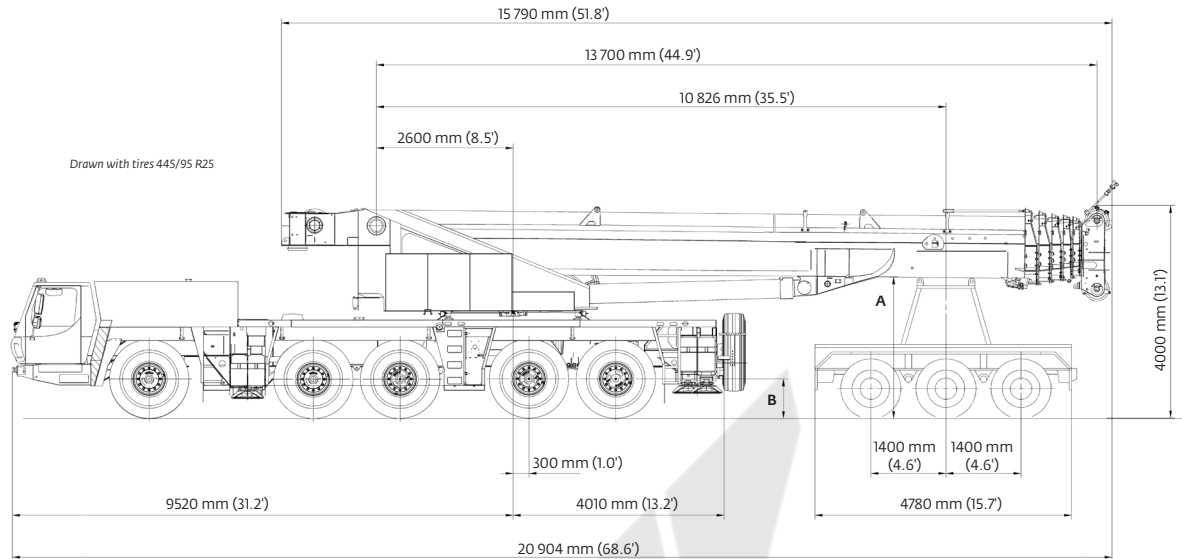

Basic weights - kg (lb)	Axles 1 - 3		Axles 4 and 5		3 Dolly axles		Total	
GMK 5225 Mercedes-Benz Tier 4i power with: 20.50 R25 tires, 10x8x10 drive/steer, 36 ft - 59 ft hydraulic luffing swingaway, 2nd oil cooler, outrigger pads, auxiliary hoist, driver and tanks filled, 3 axle boom dolly 4128 kg (9100 lb)	28 860	(63,624)	20 131	(44,381)	17 328	(38,201)	66 319	(146,206)
Additions:								
5000 kg (11 000 lb) section pinned to superstructure (special counterweight version)	4845	(10,681)	155	(342)	0	(0)	5000	(11,023)
11 000 kg (24,250 lb) base section stowed on carrier	10 659	(23,499)	341	(752)	0	(0)	11 000	(24,251)
Removals:								
Brackets for hydraulic swingaway	-36	(-79)	-16	(-35)	-48	(-106)	-101	(-223)
Hose reel + parts for hydraulic swingaway	-56	(-123)	-25	(-55)	-129	(-284)	-210	(-463)
11 m - 18 m (36 ft - 59 ft) hydraulic swingaway	-206	(-454)	-92	(-203)	-1185	(-2612)	-1483	(-3269)
Front outriggers	-2350	(-5181)	289	(637)	0	(0)	-2061	(-4544)
Rear outriggers	1093	(2410)	-3586	(-7906)	0	(0)	-2493	(-5496)
Front and rear outrigger floats	-70	(-154)	-130	(-287)	0	(0)	-200	(-441)
Substitutions:								
10x6x10 drive/steer	-337	(-743)	-38	(-84)	0	(0)	-375	(-827)
14.00 R25 tires	-730	(-1609)	-300	(-661)	0	(0)	-1030	(-2271)
16.00 R25 tires	-305	(-672)	-125	(-276)	0	(0)	-430	(-948)

Boom over front	Axles 1 - 3		Axles 4 and 5		Total	
Basic weights-kg (lb)						
Mercedes-Benz Tier 4i power, 16.00 R25 tires, 10x6x10 drive/steer, 2nd oil cooler, outrigger pads, auxiliary hoist, driver and tanks filled	34 303	(75,625)	25 024	(55,170)	59 327	(130,794)
Additions:						
10x8x10 drive/steer	323	(712)	37	(82)	360	(794)
Transmission integrated retarder	52	(115)	-12	(-26)	40	(88)
Spare wheel 14.00 R25 XGC steel rim with stowage	-134	(-295)	373	(822)	239	(527)
Spare wheel 16.00 R25 XGC steel rim with stowage	-166	(-366)	461	(1016)	295	(650)
Spare wheel 20.5 R25 XGC steel rim with stowage	-192	(-423)	534	(1177)	342	(754)
Brackets for hydraulic swingaway	67	(148)	35	(77)	101	(223)
Hose reel + parts for hydraulic swingaway	195	(430)	15	(33)	210	(463)
11 m-18 m (36 ft - 59 ft) hydraulic swingaway	1906	(4202)	-423	(-933)	1483	(3269)
11 000 kg (24,250 lb) base plate stowed on carrier	10 660	(23,501)	340	(750)	11 000	(24,251)
5000 kg (11,000 lb) slab fixed to turntable (special counterweight version)	-2759	(-6083)	7759	(17,106)	5000	(11,023)
Substitutions:						
14.00 R25 tires	-361	(-796)	-241	(-531)	-602	(-1327)
20.5 R25 tires	257	(567)	172	(379)	429	(946)
Removals:						
Boom assembly w/o lift cylinder	-19 655	(-43,332)	-1480	(-3263)	-21 135	(-46,595)
Front outriggers	-2350	(-5181)	289	(637)	-2061	(-4544)
Rear outriggers	1093	(2410)	-3586	(-7906)	-2493	(-5496)
Front and rear outrigger floats	70	(154)	130	(287)	200	(441)

Counterweight

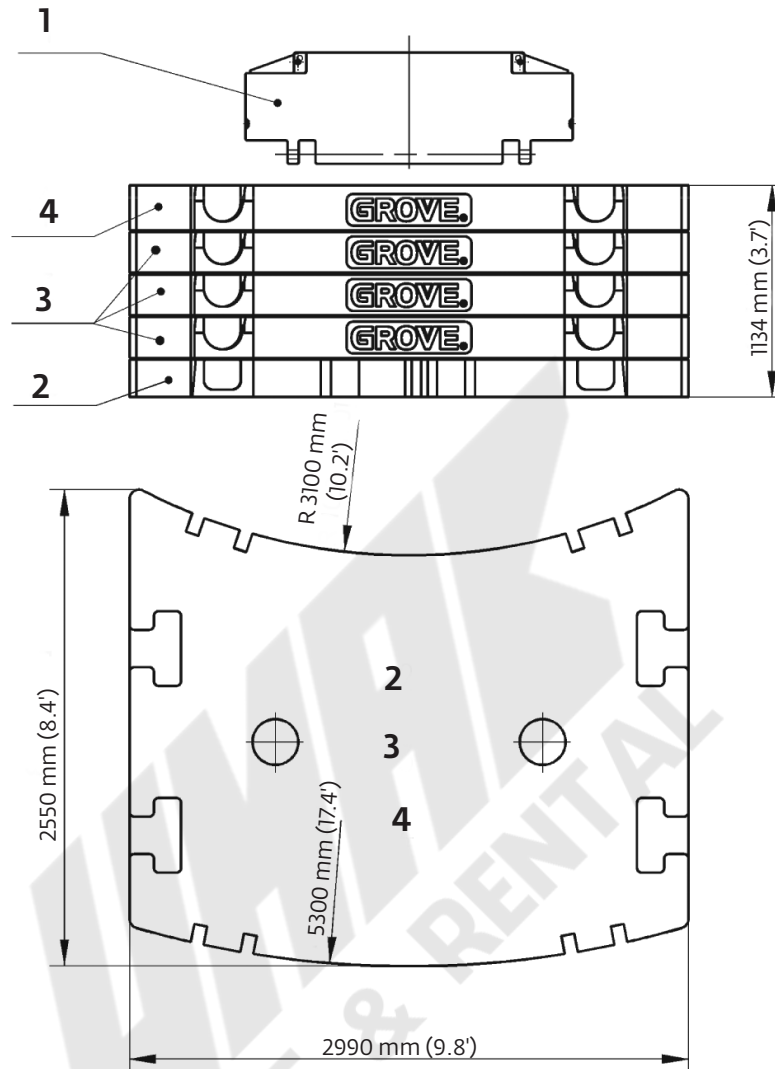

1. 1000 kg (2200 lb) Bolted (Auxiliary Hoist or IPO)
2. 11 000 kg (24,251 lb) Baseplate
3. 10 000 kg (22,046 lb) Stacking
4. 10 000 kg (22,046 lb) Stacking

	1	2	3	4
Counterweight Configuration kg (lb)				
1000 (2200)	●			
12 000 (26,450)	●	●		
22 000 (48,500)	●	●	●	
32 000 (70,500)	●	●	2●	
42 000 (92,500)	●	●	3●	
52 000 (114,600)	●	●	3●	●

Working range

13,7 m - 64 m (45 ft -210 ft) main boom

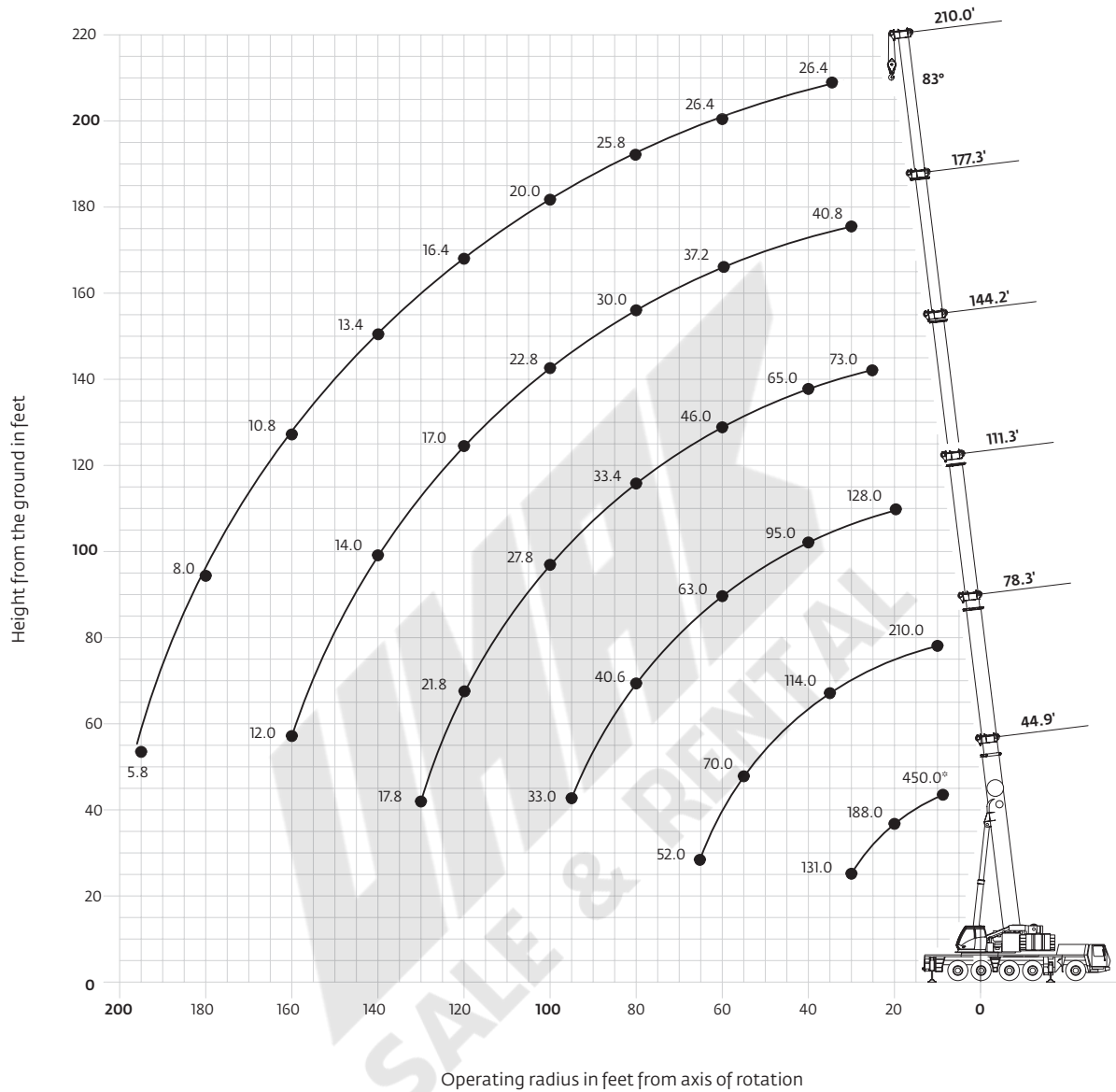

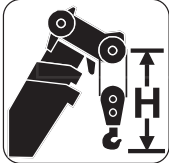
	Hook block (Ust)	H
	200D	3650 mm (12.0 ft)
160D	3650 mm (12.0 ft)	
125D	3300 mm (10.8 ft)	
80D	3300 mm (10.8 ft)	
32E	3200 mm (10.5 ft)	
12 H/B	2450 mm (8.0 ft)	

*Over rear







Hook heights shown in the working range diagram do not consider loaded boom deflection.

THIS CHART IS ONLY A GUIDE AND SHOULD NOT BE USED TO OPERATE THE CRANE.

The individual crane's load chart, operating instructions and other instructional plates must be read and understood prior to operating the crane

Load charts

Main boom





 13,7 m - 64 m (44.9 ft - 210 ft)		 52 000 kg (114,600 lb)		 28.1 ft x 26.6 ft spread (100%)		 360°					
		 Pounds x 1000									
Feet	44.9	61.7	78.3	94.8	111.3	127.5	144.2	160.8	177.3	193.8	210.0
8.0	450.0*										
9.0	310.0										
10.0	286.0										
15.0	234.0	236.0	210.0	172.0							
20.0	192.0	217.0	189.0	169.0	128.0						
25.0	161.0	188.0	171.0	153.0	128.0	97.0	73.0				
30.0	131.0	159.0	153.0	142.0	126.0	97.0	73.0	55.0			
35.0		138.0	132.0	131.0	115.0	93.0	73.0	55.0	40.8	32.2	
40.0		120.0	116.0	115.0	105.0	87.0	71.0	54.0	40.8	32.2	26.4
45.0		104.0	103.0	102.0	95.0	80.0	65.0	53.0	40.8	32.2	26.4
50.0		88.0	91.0	92.0	88.0	75.0	59.0	51.0	40.8	32.2	26.4
55.0			83.0	81.0	80.0	70.0	54.0	48.0	40.2	32.2	26.4
60.0			73.0	71.0	71.0	66.0	50.0	45.0	39.0	32.2	26.4
65.0			63.0	62.0	63.0	61.0	46.0	42.0	37.2	32.2	26.4
70.0			52.0	55.0	56.0	57.0	41.6	39.4	35.4	31.2	26.4
75.0				51.0	50.0	52.0	38.8	36.8	33.8	30.0	26.4
80.0				47.0	45.0	47.0	36.0	34.2	32.0	28.8	26.4
85.0					40.6	42.6	33.4	32.0	30.0	27.6	25.8
90.0					38.4	38.6	31.6	29.8	28.0	26.6	24.4
95.0					36.2	35.0	30.2	28.0	26.2	25.2	23.0
100.0					33.6	31.8	29.0	26.2	24.6	23.8	21.4
105.0						29.2	27.8	24.6	22.8	22.0	20.0
110.0						26.6	26.6	23.2	20.4	19.8	19.0
115.0						24.4	25.6	21.4	19.2	18.6	18.2
120.0							24.0	19.8	18.2	17.6	17.2
125.0							22.2	18.2	17.0	16.6	16.4
130.0							20.6	17.2	16.2	15.6	15.6
135.0							17.8	16.2	15.2	14.8	14.8
140.0								15.6	14.6	14.0	14.0
145.0								15.2	14.0	13.2	13.4
150.0									13.4	12.6	12.6
155.0									13.0	11.8	12.0
160.0									12.6	11.2	11.4
165.0									12.0	10.4	10.8
170.0										10.0	10.2
175.0										9.6	9.6
180.0										9.2	8.8
185.0											8.0
185.0											7.4
190.0											6.6
195.0											5.8



* Over the rear with special equipment

THIS CHART IS ONLY A GUIDE AND SHOULD NOT BE USED TO OPERATE THE CRANE.





Load charts



Main boom

 13,7 m - 64 m
(44.9 ft - 210 ft)
 
 42 000 kg
(92,500 lb)
 
 28.1 ft x 26.6 ft spread
(100%)
 
 360°



 Pounds x 1000

Feet	44.9	61.7	78.3	94.8	111.3	127.5	144.2	160.8	177.3	193.8	210.0
9.0	310.0										
10.0	286.0										
15.0	234.0										
20.0	192.0										
25.0	161.0										
30.0	131.0										
35.0											
40.0											
45.0											
50.0											
55.0											
60.0											
65.0											
70.0											
75.0											
80.0											
85.0											
90.0											
95.0											
100.0											
105.0											
110.0											
115.0											
120.0											
125.0											
130.0											
135.0											
140.0											
145.0											
150.0											
155.0											
160.0											
165.0											
170.0											
175.0											
180.0											
185.0											
190.0											
195.0											

 13,7 m - 64 m
(44.9 ft - 210 ft)
 
 32 000 kg
(70,500 lb)
 
 28.1 ft x 26.6 ft spread
(100%)
 
 360°



 Pounds x 1000





Feet	44.9	61.7	78.3	94.8	111.3	127.5	144.2	160.8	177.3	193.8	210.0
10.0	286.0	236.0	210.0	172.0							
15.0	234.0	217.0	189.0	169.0	128.0						
20.0	192.0	188.0	171.0	153.0	128.0	97.0	73.0				
25.0	161.0	160.0	153.0	142.0	126.0	97.0	73.0	55.0			
30.0	131.0	137.0	125.0	117.0	114.0	93.0	73.0	55.0	40.8	32.2	
35.0		110.0	103.0	95.0	93.0	87.0	71.0	54.0	40.8	32.2	26.4
40.0		89.0	85.0	84.0	78.0	77.0	65.0	53.0	40.8	32.2	26.4
45.0		75.0	74.0	71.0	70.0	66.0	59.0	51.0	40.8	32.2	26.4
50.0			64.0	62.0	62.0	58.0	54.0	48.0	40.2	32.2	26.4
55.0			55.0	54.0	54.0	51.0	47.0	45.0	39.0	32.2	26.4
60.0			48.0	50.0	48.0	45.0	41.8	40.2	37.2	32.2	26.4
65.0			41.8	44.0	43.2	39.8	38.8	35.4	35.2	31.2	26.4
70.0				39.4	38.4	35.4	36.2	31.4	31.2	30.0	26.4
75.0				35.2	34.2	32.0	32.6	28.0	28.0	28.2	26.4
80.0					30.4	30.2	29.4	26.4	26.0	25.4	25.8
85.0					27.2	28.8	26.8	25.0	24.6	23.6	23.4
90.0					24.4	26.2	24.4	23.8	23.4	22.0	21.2
95.0					22.8	23.8	21.8	22.4	21.6	20.4	19.2
100.0						21.6	19.8	20.6	19.8	19.0	17.4
105.0						19.6	17.8	18.6	18.6	17.6	15.8
110.0							17.8	17.2	17.0	16.0	14.4
115.0								16.4	15.6	14.8	13.0
120.0								15.6	15.0	14.2	11.8
125.0								14.2	14.2	13.2	10.6
130.0								13.2	13.0	12.2	9.6
135.0									11.8	11.2	8.6
140.0									10.8	10.0	7.8
145.0										9.2	6.8
150.0										8.4	6.0
155.0										7.6	5.2
160.0										6.8	4.6
165.0											3.8
170.0											3.2
175.0											2.6
180.0											2.0



THIS CHART IS ONLY A GUIDE AND SHOULD NOT BE USED TO OPERATE THE CRANE.

The individual crane's load chart, operating instructions and other instructional plates must be read and understood prior to operating the crane





Load charts



Main boom



Pounds x 1000

Feet	44.9	61.7	78.3	94.8	111.3	127.5	144.2	160.8	177.3	193.8	210.0
10.0	286.0	236.0	210.0	172.0							
15.0	234.0	217.0	189.0	169.0	128.0						
20.0	192.0	188.0	171.0	153.0	128.0	97.0	73.0				
25.0	157.0	149.0	137.0	125.0	120.0	97.0	73.0	55.0			
30.0	119.0	113.0	105.0	102.0	94.0	92.0	73.0	55.0	40.8	32.2	
35.0		92.0	88.0	82.0	81.0	75.0	70.0	54.0	40.8	32.2	26.4
40.0		75.0	73.0	69.0	68.0	63.0	58.0	53.0	40.8	32.2	26.4
45.0		61.0	61.0	62.0	58.0	53.0	51.0	47.0	40.8	32.2	26.4
50.0			52.0	53.0	50.0	46.0	46.0	40.4	39.6	32.2	26.4
55.0			46.0	46.0	43.0	40.8	40.0	35.2	35.2	32.2	26.4
60.0			40.0	40.2	37.6	38.2	35.0	33.0	33.0	31.6	26.4
65.0			34.8	35.0	33.2	34.2	31.0	31.0	30.4	29.0	26.4
70.0				30.6	29.4	30.4	27.4	27.6	27.2	25.8	23.6
75.0					27.0	27.8	27.4	25.6	25.8	25.0	21.0
80.0						25.8	24.6	24.2	23.8	22.4	18.6
85.0						23.0	22.0	22.4	21.6	20.2	16.6
90.0						20.6	19.6	20.4	19.6	18.2	14.8
95.0						18.6	17.6	18.2	17.8	16.6	13.0
100.0							16.8	16.4	16.2	15.0	11.6
105.0							15.8	15.2	14.6	13.6	10.2
110.0							14.4	13.8	13.2	12.2	9.0
115.0								12.4	11.8	11.0	8.0
120.0								11.2	10.6	10.0	7.0
125.0								10.2	9.6	8.8	6.0
130.0								9.2	8.6	7.8	5.2
135.0									7.6	7.0	4.4
140.0									6.8	6.0	3.6
145.0										5.2	2.8
150.0										4.6	2.2
155.0										4.0	2.8
160.0										3.4	2.2



Pounds x 1000

Feet	44.9	61.7	78.3	94.8	111.3	127.5	144.2	160.8	177.3	193.8	210.0
10.0	286.0	236.0	210.0	172.0							
15.0	234.0	217.0	189.0	169.0	128.0						
20.0	187.0	171.0	153.0	137.0	128.0	97.0	73.0				
25.0	129.0	120.0	114.0	105.0	100.0	93.0	73.0	55.0			
30.0	95.0	92.0	87.0	84.0	79.0	72.0	66.0	55.0	40.8	32.2	
35.0		72.0	68.0	68.0	63.0	58.0	57.0	50.0	40.8	32.2	26.4
40.0		60.0	59.0	56.0	52.0	52.0	47.0	43.8	39.8	32.2	26.4
45.0		48.0	49.0	47.0	43.2	43.8	39.6	39.2	38.2	32.2	26.4
50.0			41.4	39.6	38.6	37.4	35.4	25.6	33.4	30.8	26.4
55.0			34.8	34.0	34.8	32.2	32.0	30.8	29.0	26.6	24.2
60.0			30.2	29.4	30.4	28.0	28.6	27.0	25.2	23.2	20.8
65.0			25.8	27.4	26.8	24.6	25.2	23.8	22.2	20.2	18.0
70.0				24.0	23.8	21.6	22.4	21.0	19.4	17.6	15.6
75.0				20.8	20.8	19.0	19.8	18.6	17.2	15.4	13.4
80.0					18.2	16.8	17.8	16.4	15.2	13.4	11.6
85.0					16.6	15.0	15.8	14.6	13.4	11.6	9.8
90.0					14.6	13.0	14.2	13.0	11.8	10.2	8.4
95.0					13.0	11.4	12.6	11.6	10.4	8.8	7.0
100.0						9.8	11.2	10.2	9.0	7.6	6.0
105.0						8.6	9.8	9.0	8.0	6.4	4.8
110.0						7.4	8.6	8.0	7.0	5.4	3.8
115.0							7.6	7.0	6.0	4.6	3.0
120.0							6.6	6.0	5.2	3.6	2.2
125.0							5.6	5.0	4.4	3.0	
130.0							5.0	4.2	3.6	2.2	
135.0								3.6	2.8		
140.0								2.8	2.0		

Load charts

Main boom

13,7 m - 64 m
(44.9 ft - 210 ft)

1000 kg
(2200 lb)

28.1 ft x 26.6 ft spread
(100%)

360°



Pounds x 1000

Feet	44.9	61.7	78.3	94.8	111.3	127.5	144.2	160.8	177.3	193.8	210.0
10.0	286.0	236.0	210.0	172.0							
15.0	234.0	215.0	187.0	159.0	128.0						
20.0	140.0	130.0	118.0	106.0	101.0	89.0	73.0				
25.0	92.0	88.0	85.0	79.0	72.0	69.0	62.0	53.0			
30.0	64.0	65.0	63.0	59.0	56.0	53.0	50.0	46.0	38.6	32.2	
35.0		49.0	49.0	46.0	46.0	43.6	42.2	39.2	35.6	31.6	26.4
40.0		39.0	39.8	39.6	37.6	36.8	34.6	32.2	29.8	27.0	24.2
45.0		31.0	32.6	32.8	31.8	30.8	28.8	26.8	24.8	22.4	19.8
50.0			27.0	27.4	26.8	26.0	24.4	22.6	20.8	18.4	16.2
55.0			22.4	23.2	22.8	22.0	20.6	19.0	17.4	15.4	13.2
60.0			18.4	19.8	19.4	18.8	17.6	16.2	14.6	12.8	10.8
65.0			15.2	17.0	16.8	16.2	15.0	13.8	12.4	10.6	8.6
70.0				14.2	14.4	14.0	13.0	11.6	10.4	8.6	6.8
75.0				12.0	12.4	12.2	11.0	9.8	8.6	7.0	5.2
80.0					10.6	10.4	9.4	8.4	7.2	5.6	3.8
85.0					8.8	9.0	8.0	7.0	5.8	4.2	2.6
90.0					7.4	7.6	6.8	5.8	4.6	3.2	
95.0					6.2	6.4	5.8	4.6	3.6	2.0	
100.0						5.2	4.8	3.8	2.6		
105.0						4.2	3.8	2.8			
110.0						3.4	3.0	2.0			
115.0							2.2				

WMA
SALE & RENTAL

THIS CHART IS ONLY A GUIDE AND SHOULD NOT BE USED TO OPERATE THE CRANE.

The individual crane's load chart, operating instructions and other instructional plates must be read and understood prior to operating the crane

Working range

64 m (210 ft) main boom, 11 m - 18 m (36 ft - 59 ft) swingaway and 2 X 8 m (26 ft) inserts

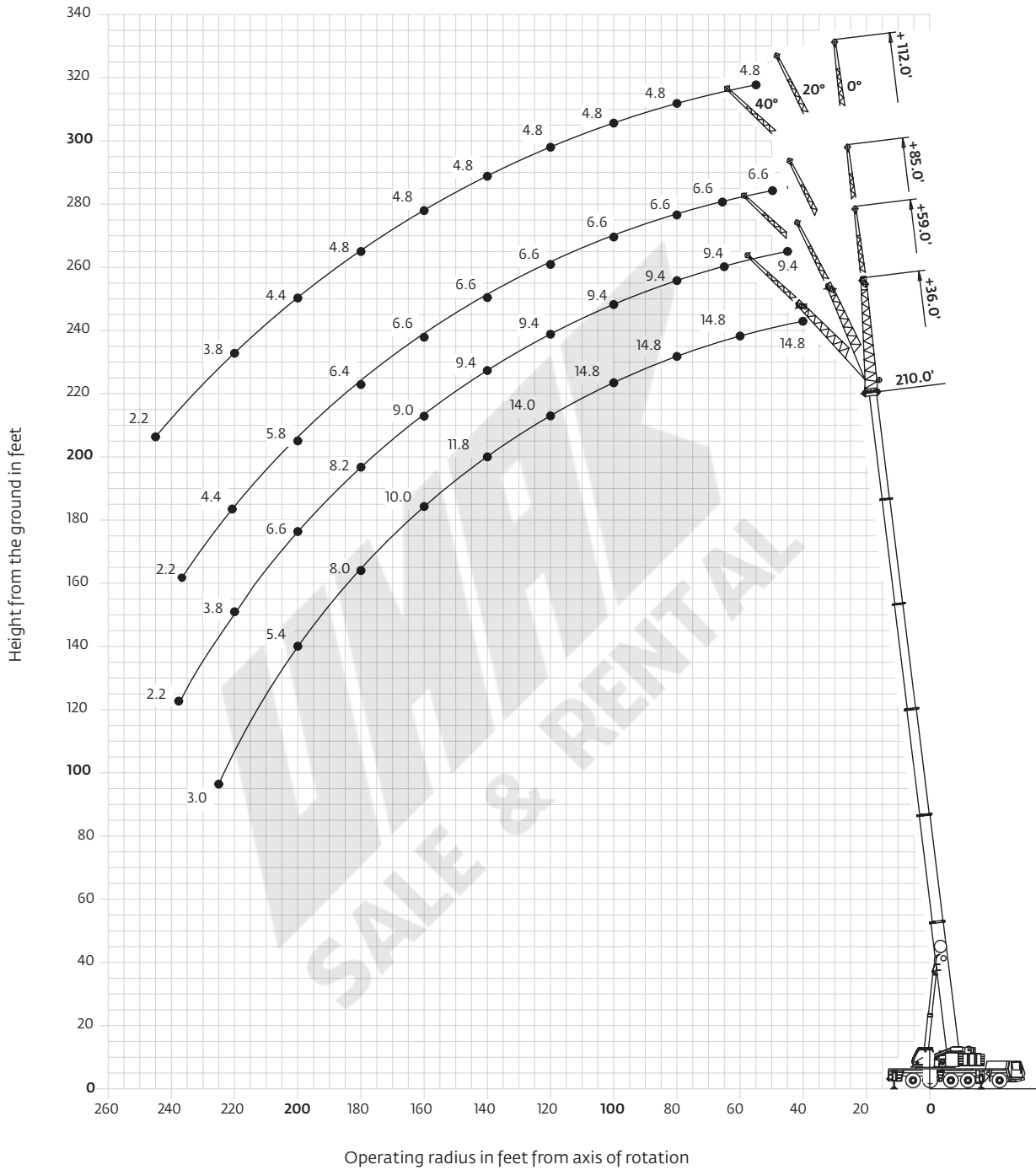

Hook heights shown in the working range diagram do not consider loaded boom deflection.

THIS CHART IS ONLY A GUIDE AND SHOULD NOT BE USED TO OPERATE THE CRANE.

Grove GMK5225 Tier 4i *The individual crane's load chart, operating instructions and other instructional plates must be read and understood prior to operating the crane*

Load charts

Hydraulic offsettable swingaway

Intermediate angle



64 m
(210 ft)



11-18-26-34 m
(36-59-85-112 ft)



52 000 kg
(114,600 lb)



28.1 ft x 26.6 ft spread
(100%)



360°



Pounds x 1000

Feet	210' + 36'			210' + 59'			210' + 85'			210' + 112'		
	0°	0°- 20°	20°- 40°	0°	0°- 20°	20°- 40°	0°	0°- 20°	20°- 40°	0°	0°- 20°	20°- 40°
40.0	14.8			9.4								
45.0	14.8			9.4								
50.0	14.8	14.8		9.4			6.6					
55.0	14.8	14.8	14.8	9.4	9.4		6.6			4.8		
60.0	14.8	14.8	14.8	9.4	9.4		6.6			4.8		
65.0	14.8	14.8	14.8	9.4	9.4		6.6			4.8		
70.0	14.8	14.8	14.8	9.4	9.4		6.6	6.6		4.8		
75.0	14.8	14.8	14.8	9.4	9.4	9.4	6.6	6.6		4.8	4.8	
80.0	14.8	14.8	14.8	9.4	9.4	9.4	6.6	6.6	6.2	4.8	4.8	
85.0	14.8	14.8	14.8	9.4	9.4	9.4	6.6	6.6	6.2	4.8	4.8	
90.0	14.8	14.8	14.8	9.4	9.4	9.4	6.6	6.6	6.2	4.8	4.8	3.6
95.0	14.8	14.8	14.8	9.4	9.4	9.4	6.6	6.6	6.2	4.8	4.8	3.6
100.0	14.8	14.8	14.8	9.4	9.4	9.2	6.6	6.6	6.2	4.8	4.8	3.6
105.0	14.8	14.8	14.8	9.4	9.4	9.2	6.6	6.6	6.2	4.8	4.8	3.6
110.0	14.8	14.4	14.2	9.4	9.4	9.2	6.6	6.6	6.2	4.8	4.8	3.4
115.0	14.6	14.0	13.8	9.4	9.4	9.2	6.6	6.6	6.2	4.8	4.8	3.4
120.0	14.0	13.6	13.4	9.4	9.4	9.2	6.6	6.6	6.2	4.8	4.8	3.4
125.0	13.2	13.2	13.0	9.4	9.4	9.0	6.6	6.6	6.2	4.8	4.8	3.4
130.0	12.6	12.6	12.6	9.4	9.4	9.0	6.6	6.6	6.2	4.8	4.8	3.4
135.0	12.0	12.2	12.2	9.4	9.4	9.0	6.6	6.6	6.2	4.8	4.8	3.4
140.0	11.6	11.8	11.8	9.4	9.2	8.8	6.6	6.6	6.2	4.8	4.8	3.4
145.0	11.0	11.2	11.4	9.4	9.2	8.8	6.6	6.6	6.2	4.8	4.8	3.4
150.0	10.6	10.8	11.0	9.4	9.2	8.8	6.6	6.6	6.2	4.8	4.8	3.4
155.0	10.0	10.2	10.6	9.4	9.0	8.8	6.6	6.6	6.2	4.8	4.8	3.4
160.0	9.6	9.8	10.0	9.0	8.8	8.8	6.6	6.6	6.2	4.8	4.8	3.4
165.0	9.2	9.4	9.6	8.8	8.6	8.6	6.6	6.6	6.2	4.8	4.8	3.4
170.0	8.8	9.0	9.2	8.4	8.4	8.4	6.6	6.6	6.2	4.8	4.8	3.4
175.0	8.2	8.6	8.8	8.0	8.2	8.4	6.6	6.6	6.2	4.8	4.8	3.4
180.0	7.8	8.0	8.4	7.6	8.0	8.2	6.4	6.4	6.2	4.8	4.8	3.4
185.0	7.4	7.4		7.4	7.6	8.0	6.2	6.2	6.2	4.8	4.8	3.4
190.0	6.8	6.8		7.0	7.4	7.6	6.0	6.0	6.2	4.8	4.8	3.4
195.0	6.0	6.0		6.8	7.0	7.4	5.8	5.8	6.0	4.6	4.6	3.4
200.0	5.4	5.4		6.4	6.4	7.0	5.6	5.8	5.8	4.4	4.4	3.4
205.0	5.0	5.0		5.8	5.8		5.4	5.4	5.8	4.2	4.4	3.4
210.0	4.4	4.4		5.2	5.2		5.2	4.8	5.6	4.0	4.2	3.4
215.0	4.0	4.0		4.8	4.8		4.8	4.4	5.4	4.0	4.0	3.4
220.0	3.4	3.4		4.2	4.2		4.4	3.8	5.0	3.8	3.8	3.4
225.0	3.0			3.8	3.8		3.8	3.4		3.6	3.8	3.4
230.0				3.4	3.4		3.4	3.0		3.4	3.4	3.4
235.0				3.0	3.0		3.0	2.6		3.0	3.0	3.4
240.0				2.6	2.6		2.6	2.2		2.6	2.6	3.2
245.0				2.2			2.2			2.2	2.2	

THIS CHART IS ONLY A GUIDE AND SHOULD NOT BE USED TO OPERATE THE CRANE.

The individual crane's load chart, operating instructions and other instructional plates must be read and understood prior to operating the crane.

Load charts

Hydraulic offsettable swingaway

Loads for luffing



64 m
(210 ft)



11-18-26-34 m
(36-59-85-112 ft)



52 000 kg
(114,600 lb)



28.1 ft x 26.6 ft spread
(100%)



360°



Pounds x 1000

Feet	210' + 36'		210' + 59'		210' + 85'		210' + 85'	
	0°- 20°	20°- 40°	0°- 20°	20°- 40°	0°- 20°	20°- 40°	0°- 20°	20°- 40°
50.0	14.8							
55.0	14.8	14.6	9.4					
60.0	14.8	14.6	9.4					
65.0	14.8	14.6	9.4					
70.0	14.8	14.6	9.4					
75.0	14.8	14.6	9.4		6.6			
80.0	14.8	14.6	9.2	9.0	6.6	5.8	4.8	
85.0	14.8	14.6	9.2	9.0	6.6	5.8	4.8	
90.0	14.8	14.6	9.2	9.0	6.6	5.8	4.8	3.4
95.0	14.8	14.6	9.2	8.8	6.6	5.8	4.8	3.4
100.0	14.6	14.4	9.2	8.8	6.6	5.8	4.8	3.4
105.0	14.2	14.0	9.2	8.8	6.6	5.8	4.8	3.4
110.0	13.8	13.6	9.2	8.8	6.6	5.8	4.8	3.4
115.0	13.2	13.2	9.0	8.8	6.6	5.8	4.8	3.4
120.0	12.8	12.8	9.0	8.6	6.6	5.8	4.8	3.4
125.0	12.4	12.4	9.0	8.6	6.6	5.8	4.8	3.4
130.0	12.0	12.0	9.0	8.6	6.6	5.8	4.8	3.4
135.0	11.6	11.6	8.8	8.6	6.6	5.8	4.8	3.4
140.0	11.2	11.2	8.8	8.4	6.6	5.8	4.8	3.4
145.0	10.6	11.0	8.8	8.4	6.6	5.8	4.8	3.4
150.0	10.2	10.6	8.6	8.4	6.6	5.8	4.8	3.4
155.0	9.8	10.0	8.6	8.2	6.6	5.8	4.8	3.4
160.0	9.4	9.6	8.4	8.2	6.6	5.8	4.8	3.4
165.0	9.0	9.2	8.2	8.2	6.6	5.8	4.8	3.4
170.0	8.6	8.8	8.0	8.0	6.6	5.8	4.8	3.4
175.0	8.0	8.4	7.8	8.0	6.4	5.8	4.8	3.4
180.0	7.4	7.8	7.6	7.8	6.2	5.8	4.8	3.4
185.0	6.8		7.4	7.6	6.0	5.8	4.8	3.4
190.0	6.2		7.0	7.2	5.8	5.8	4.6	3.4
195.0	5.6		6.4	7.0	5.6	5.8	4.4	3.4
200.0	5.0		5.8	6.4	5.4	5.6	4.2	3.4
205.0	4.4		5.2		5.2	5.4	4.2	3.4
210.0	4.0		4.8		4.8	5.2	4.0	3.4
215.0	3.6		4.4		4.4	5.0	3.8	3.4
220.0	3.2		3.8		4.0	4.6	3.6	3.4
225.0			3.4		3.4		3.4	3.4
230.0			3.0		3.0		3.0	3.4
235.0			2.8		2.8		2.6	3.2
240.0			2.4		2.4		2.2	2.8
245.0							2.0	

THIS CHART IS ONLY A GUIDE AND SHOULD NOT BE USED TO OPERATE THE CRANE.

Working range

13,7 m - 64 m (45 ft - 210 ft) main boom with 3,6 m (11.8 ft) heavy duty jib

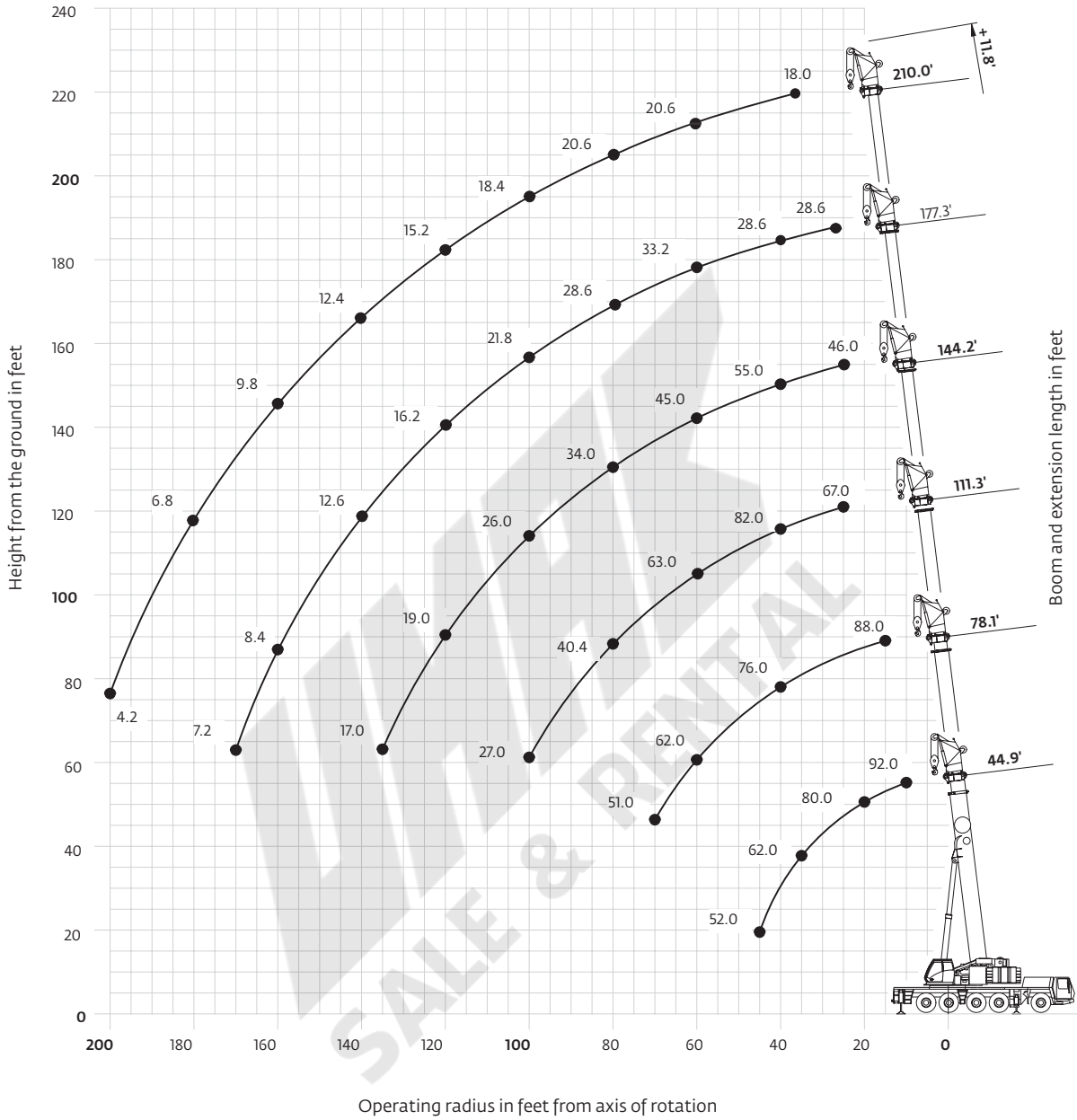

Hook heights shown in the working range diagram do not consider loaded boom deflection.





THIS CHART IS ONLY A GUIDE AND SHOULD NOT BE USED TO OPERATE THE CRANE.

The individual crane's load chart, operating instructions and other instructional plates must be read and understood prior to operating the crane.

Load charts

Integrated heavy duty jib

Intermediate angle

13,7 m - 64 m
(44.9 ft - 210 ft)

3,6 m
(11.8 ft)

52 000 kg
(114,600 lb)

28.1 ft x 26.6 ft spread
(100%)

360°

Feet	44.9' + 11.8'			78.1' + 11.8'			111.3' + 11.8'			144.2' + 11.8'			177.3' + 11.8'			210.0' + 11.8'		
	0°	< 20°	< 40°	0°	< 20°	< 40°	0°	< 20°	< 40°	0°	< 20°	< 40°	0°	< 20°	< 40°	0°	< 20°	< 40°
10.0	92.0	88.0	88.0															
15.0	85.0	85.0	85.0															
20.0	80.0	79.0	80.0	91.0	87.0	88.0			67.0									
25.0	72.0	73.0	75.0	87.0	85.0	85.0			67.0			46.0						
30.0	64.0	67.0	71.0	83.0	83.0	82.0			67.0			46.0			28.6			
35.0	59.0	62.0		79.0	78.0	79.0	84.0	70.0	67.0			46.0			28.6			
40.0	55.0	61.0		74.0	74.0	76.0	82.0	70.0	67.0	55.0	46.0	46.0			28.6			18.0
45.0	52.0			69.0	70.0	73.0	79.0	70.0	67.0	54.0	46.0	46.0	33.2	28.6	28.6			18.0
50.0				64.0	67.0	71.0	73.0	70.0	67.0	51.0	46.0	46.0	33.2	28.6	28.6			18.0
55.0				61.0	64.0	69.0	68.0	68.0	67.0	48.0	46.0	46.0	33.2	28.6	28.6	20.6	18.0	18.0
60.0				57.0	62.0		62.0	63.0	63.0	45.0	45.0	45.0	33.2	28.6	28.6	20.6	18.0	18.0
65.0				55.0	58.0		56.0	56.0	57.0	41.2	41.4	42.2	31.8	28.6	28.6	20.6	18.0	18.0
70.0				52.0	52.0		51.0	51.0	51.0	38.6	38.6	39.2	30.6	28.6	28.6	20.6	18.0	18.0
75.0							46.0	46.0	46.0	35.8	36.0	36.4	29.2	28.6	28.6	20.6	18.0	18.0
80.0							41.2	41.2	41.2	33.4	33.6	34.0	28.0	27.8	28.6	20.6	18.0	18.0
85.0							37.0	37.2	37.2	31.4	31.4	31.8	26.6	26.6	27.2	20.6	18.0	18.0
90.0							33.4	33.6		29.4	29.4	29.8	25.0	25.0	25.4	20.6	18.0	18.0
95.0							30.4	30.4		27.4	27.6	27.8	23.4	23.4	23.0	19.4	18.0	18.0
100.0							27.6	27.8		25.8	26.0	26.0	21.8	21.8	20.8	18.4	18.0	18.0
105.0										24.4	24.4	24.0	20.0	20.0	19.6	17.4	17.4	17.8
110.0										23.0	23.0	22.0	18.2	18.4	18.4	16.6	16.6	16.8
115.0										21.0	21.0		17.0	17.0	17.2	15.6	15.8	16.0
120.0										19.0	19.0		16.0	16.0	16.2	15.0	15.0	15.2
125.0										18.0	18.4		15.0	15.0	15.2	14.2	14.2	14.4
130.0										17.4	17.8		14.2	14.2	14.4	13.6	13.6	13.8
135.0										17.0	14.6		13.4	13.4		12.8	13.0	13.0
140.0													12.6	12.6		12.2	12.2	12.4
145.0													12.0	12.0		11.6	11.6	11.8
150.0													11.0	11.0		11.0	11.0	11.0
155.0													10.0	10.0		10.4	10.4	10.4
160.0													9.0	9.0		9.8	9.8	
165.0													8.2			9.2	9.2	
170.0													7.4			8.8	8.8	
175.0																8.2	8.2	
180.0																7.4	7.4	
185.0																6.8	6.8	
190.0																6.0	6.0	
195.0																5.4	5.4	
200.0																4.8		

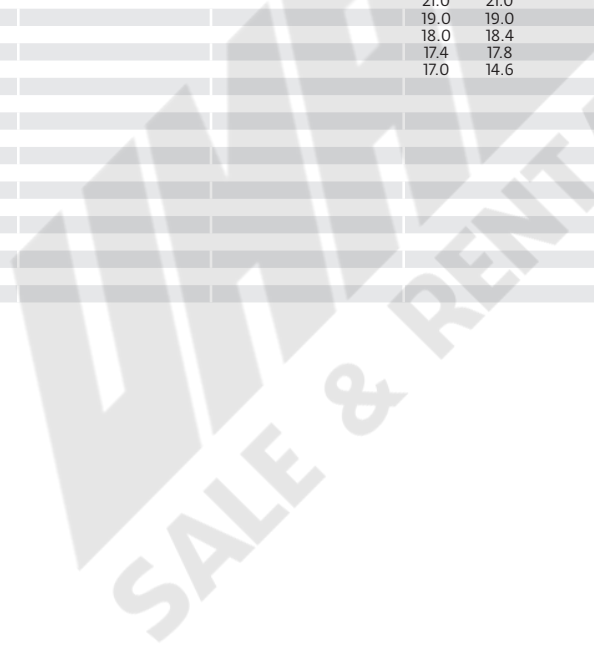

THIS CHART IS ONLY A GUIDE AND SHOULD NOT BE USED TO OPERATE THE CRANE.

Grove GMK5225 Tier 4i The individual crane's load chart, operating instructions and other instructional plates must be read and understood prior to operating the crane.

Load charts

Integrated heavy duty jib

Loads for luffing

13,7 m - 64 m (44.9 ft - 210 ft)
 3,6 m (11.8 ft)
 52 000 kg (114,600 lb)
 28.1 ft x 26.6 ft spread (100%)
 360°

































Pounds x 1000

Feet	44.9' + 11.8'		78.1' + 11.8'		111.3' + 11.8'		144.2' + 11.8'		177.3' + 11.8'		210.0' + 11.8'	
	0°- 20°	20°- 40°	0°- 20°	20°- 40°	0°- 20°	20°- 40°	0°- 20°	20°- 40°	0°- 20°	20°- 40°	0°- 20°	20°- 40°
10.0	65.0	65.0										
15.0	63.0	63.0		66.0								
20.0	59.0	61.0	64.0	64.0		64.0						
25.0	56.0	61.0	63.0	63.0		64.0		43.6				
30.0	54.0	61.0	61.0	62.0	64.0	64.0		43.6		27.4		
35.0	53.0		59.0	61.0	63.0	63.0		43.6		27.4		
40.0	52.0		57.0	61.0	62.0	62.0	44.0	43.6		27.4		17.4
45.0			56.0	60.0	61.0	62.0	44.0	43.6	27.4	27.4		17.4
50.0			54.0	60.0	59.0	61.0	44.0	43.6	27.4	27.4		17.4
55.0			53.0	61.0	58.0	61.0	44.0	43.6	27.4	27.4	18.0	17.4
60.0			52.0		56.0	60.0	42.8	43.2	27.4	27.4	18.0	17.4
65.0			52.0		53.0	53.0	39.4	40.2	27.4	27.4	18.0	17.4
70.0			47.0		47.0	47.0	36.8	37.4	27.4	27.4	18.0	17.4
75.0					41.8	42.0	34.2	34.8	27.4	27.4	18.0	17.4
80.0					37.6	37.6	32.0	32.2	26.6	27.2	18.0	17.4
85.0					33.8	33.8	30.0	30.2	25.2	26.0	18.0	17.4
90.0					30.6		28.0	28.2	23.8	24.2	18.0	17.4
95.0					27.6		26.2	26.6	22.4	22.0	18.0	17.4
100.0					25.2		24.8	24.8	20.8	19.8	17.4	17.4
105.0							22.8	22.8	19.2	18.6	16.6	17.0
110.0							20.8	20.8	17.4	17.4	15.8	16.0
115.0							19.0		16.2	16.4	15.0	15.2
120.0							18.2		15.4	15.4	14.4	14.6
125.0							17.4		14.4	14.4	13.6	13.8
130.0							16.8		13.6	13.6	13.0	13.2
135.0							13.2		12.8		12.4	12.4
140.0									12.0		11.6	11.8
145.0									11.0		11.0	11.2
150.0									10.0		10.4	10.6
155.0									9.0		9.8	10.0
160.0									8.2		9.4	
165.0											8.8	
170.0											8.2	
175.0											7.4	
180.0											6.8	
185.0											6.2	
190.0											5.6	
195.0											5.0	

THIS CHART IS ONLY A GUIDE AND SHOULD NOT BE USED TO OPERATE THE CRANE.

The individual crane's load chart, operating instructions and other instructional plates must be read and understood prior to operating the crane.

Symbols glossary

 Axles	 Counterweight	 Grade	 Radius
 Boom	 Drive	 Hoist	 Rotation
 Boom elevation	 Electrical system	 Hookblock	 Speed
 Boom extension	 Engine	 Hydraulic system	 Steering
 Boom length	 Extension	 Lights	 Suspension
 Boom nose	 Frame	 Oil	 Swing
 Brakes	 Fuel tank capacity	 Outrigger controls	 Tires
 Cab	 Gear	 Outriggers	 Transmission





Manitowoc Cranes

Regional headquarters

Americas

Manitowoc, Wisconsin, USA

Tel: +1 920 684 6621

Fax: +1 920 683 6277

Shady Grove, Pennsylvania, USA

Tel: +1 717 597 8121

Fax: +1 717 597 4062

Europe, Middle East, Africa

Dardilly, France

Tel: +33 (0)4 72 18 20 20

Fax: +33 (0)4 72 18 20 00

China

Shanghai, China

Tel: +86 21 6457 0066

Fax: +86 21 6457 4955

Greater Asia-Pacific

Singapore

Tel: +65 6264 1188

Fax: +65 6862 4040

Regional offices

Americas

Brazil

Alphaville

Mexico

Monterrey

Chile

Santiago

Europe, Middle East,

Africa

France

Dardilly

Saint Pierre de Chandieu

Germany

Langenfeld

Italy

Lainate

Netherlands

Breda

Poland

Warsaw

Portugal

Baltar

Russia

Moscow

South Africa

Johannesburg

U.A.E.

Dubai

U.K.

Buckingham

China

Beijing

Chengdu

Guangzhou

Xian

Greater Asia-Pacific

Australia

Brisbane

Sydney

India

Ahmedabad

Bengaluru

Chennai

Gurgaon

Hyderabad

Kolkata

Mumbai

Noida

Pune

Korea

Seoul

Philippines

Makati City

Singapore

Factories

Brazil

Passo Fundo

China

Zhangjiagang

France

Charlieu

Moulins

Germany

Wilhelmshaven

India

Pune

Italy

Niella Tanaro

Portugal

Baltar

Fânzeres

USA

Manitowoc

Port Washington

Shady Grove

This document is non-contractual. Constant improvement and engineering progress make it necessary that we reserve the right to make specification, equipment, and price changes without notice. Illustrations shown may include optional equipment and accessories and may not include all standard equipment.

Grove GMK5225

Product Guide



Features

- 170 t (225 USt) capacity
- 13,7 m - 64 m (45 ft - 210 ft) six-section full power MEGAFORM™ boom with TWIN-LOCK™ pinning
- Chassis engine: Cummins QSX15, six-cylinder, 399 kW (535 hp), torque 1873 ft/lb (1400 rpm). * Alternate engine: Mercedes Benz OM 502 LA, eight-cylinder, 420 kW (563 hp)
- Superstructure engine: Cummins QSB 6.7, six-cylinder 164 kW (220 hp), torque 700 ft/lb (1500 rpm). *Alternate engine: Mercedes Benz OM 906 LA, six-cylinder, 170 kW (228 hp)
- Allison 4000SP transmission

Features

MEGATRAK™

The MEGATRAK™ suspension system is the best off road driveline available on the market today. The system's versatility and performance allows the GMK5225 to operate as a true all-terrain crane. The MEGATRAK™ independent suspension and all-wheel steer system allows wheels to remain on the ground at all times so stresses and weight are not continually transferred between axles. MEGATRAK™ provides true ground clearance where others just raise the chassis.

Other benefits of the MEGATRAK™ system are:

- A reliable suspension system
- Excellent job site maneuverability with all-wheel steering
- Commonality among almost all models
- A driveline that remains aligned at all times
- A steering linkage system that is protected against damage
- Constant tire contact for equal tire wear
- Reduced maintenance



Engine

With two engine options, the GMK5225 provides you with the power you need.

Standard engine: Cummins QSB 6.7, six-cylinder
Horsepower: 164 kW (220 bhp) at 2200 rpm
Torque: 949 Nm (700 ft/lb) at 1500 rpm
Engine Emissions: EPA/CARB/EUROMOT (off road)

Alternate engine: *Mercedes Benz OM 906 LA, six-cylinder
Horsepower: 170 kW (228 bhp) at 2200 rpm
Torque: 810 Nm (597 ft/lb) at 1200 rpm
Engine Emissions: EPA/CARB/EUROMOT (off road)



TWIN-LOCK™

Boom pinning mechanism automatically pins the sections in position using two horizontal pins.

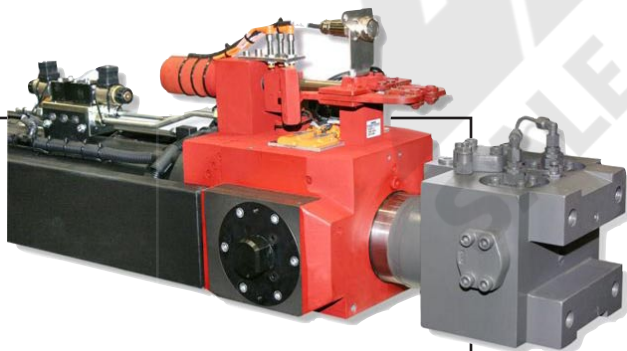

EKS 5

The EKS 5 monitors the lifting conditions of the crane at all times and provides a full graphic display, rear lighting, graphic of boom telescoping percentage, and load charts.

ECOS

Electronic Crane Operating System - ECOS enables control of the entire crane's principle operations. Simple programming eases lift planning and a supply of essential information allows full concentration on the lift itself.



Contents

Specifications	4
Dimensions	7
Weight proposals	8
Counterweight	10
Working range (main boom)	11
Load charts (main boom)	12
Working range (swingaway and inserts)	15
Load charts (hydraulically offsettable swingaway)	16
Load charts (manual offsettable swingaway)	19
Working range (heavy duty jib)	20
Load charts (heavy duty jib)	21
Symbols glossary	24
Notes	25

Specifications

Superstructure



Boom

13,7 m - 64 m (45 ft - 210 ft) 6-section, full power MEGAFORM™ boom with patented TWIN-LOCK™ boom pinning system. Maximum tip height: 67 m (220 ft).



Boom nose

Seven nylatron sheaves, mounted on heavy duty tapered roller bearings with removable pin-type rope guards. Quick reeve boom nose. Removable auxiliary boom nose with removable pin type rope guard.



Boom elevation

Single lift cylinder with safety valve provides boom angle from -1,5° to +83°.



Hydraulic offsettable lattice extension

11 m - 18 m (36 ft - 59 ft) bi-fold lattice swingaway extension hydraulically offsettable and luffing under load: 0° - 40°. Controlled from the crane cab. Maximum tip height: 85 m (279 ft)



*Manual offsettable lattice extension

11 m - 18 m (36 ft - 59 ft) bi-fold lattice swingaway extension manually offsettable 0°, 20° or 40°. Maximum tip height: 85 m (279 ft)



Lattice inserts

2 x 8 m (26 ft) inserts for use with lattice swingaway extension to increase length to 26 m (85 ft) or 34 m (112 ft). Maximum tip height: 101 m (331 ft)



Load moment and anti-two block system

Load moment and anti-two block system with audio/visual warning and control lever lockout provides electronic display of boom angle, length, radius, tip height, relative load moment, maximum permissible load, load indication and warning of impending two-block condition.



Cab

All aluminum constructed cab with acoustical lining, hydraulic tilted to 20°. Includes tinted safety glass, adjustable operator's seat, opening windows at side and rear, hinged windshield with wiper, sun visor and window shade. Other features include, engine-dependent hot water heater/defroster, armrest integrated crane controls, and ergonomically arranged instrumentation.



Swing

Three planetary gear boxes with fixed displacement axial piston motors. Infinitely variable to 1.3 rpm. Free swing or hydrostatically engaged brake controlled by swing lever. Swing brake selected by foot operated switch.



Counterweight

53 t (116,800 lb) consisting of various sections with hydraulic installation/removal system. Controlled from the superstructure cab.



Engine - North American version

Cummins QSB 6.7, 6-cylinder
Horsepower: 164 KW (220 bph) at 2200 rpm
Torque: 949 Nm (700 ft/lb) at 1500 rpm
Engine Emissions: EPA/CARB/EUROMOT (off road)



*Engine

*Alternate engine: Mercedes Benz OM 906 LA, 6 cylinder
Horsepower: 170 kW (228 bhp) at 2200 rpm
Torque: 810 Nm (597 ft/lb) at 1200 rpm
Engine Emissions: EPA/CARB/EUROMOT (off road)



Fuel tank capacity

240 L (63 gal)



Electrical system

3 phase alternator: 28V/80A
2 batteries: 12V/170Ah

Specifications

Superstructure continued



Hydraulic system

2 separate circuits, 1 axial piston variable displacement pump (load sensing) with electronic power limiting control and 1 double gear pump for slewing. Thermostatically controlled oil coolers keep oil at optimum operating temperature. Hydraulic tank capacity: 915 L (242 gal)



Hoist

Main and auxiliary hoists are powered by axial piston motor with planetary gear and brake. "Thumb-thumper" hoist drum rotation indicator alerts operator of hoist movement.

	Main	Auxiliary
Rope length:	290 m (951 ft)	290 m (951 ft)
Rope diameter:	22 mm	22 mm
Line speed:	125m/min (410 fpm)	125 m/min (410 fpm)
Line pull:	93.0 kN (20,907 lb)	93.0 kN (20,907 lb)

*Optional equipment

- ▶ 3,6 m (11.8 ft) side-stowed 3-sheave integrated heavy duty jib
- ▶ Work lights, mounted on boom base section
- ▶ Radio/CD player for superstructure cab
- ▶ Stainless steel exhaust system with spark arrestor
- ▶ Air conditioning
- ▶ Hook blocks/headache ball
- ▶ Engine independent diesel cab heater, with engine pre-heater including 24-hour timer
- ▶ Engine independent propane gas cab heater
- ▶ Additional cab mounted work light
- ▶ Strobe light
- ▶ Working range limiter
- ▶ Data logger
- ▶ Camera system for boom head
- ▶ Camera system for hoists
- ▶ EKS5 Light with semi-graphic display

Carrier



Chassis

Box type, torsion resistant frame is fabricated from high strength steel.



Outrigger system

Four hydraulic two-stage outrigger beams with vertical cylinders and outrigger pads, 23.6" (600 mm) square. Outriggers can be set in 4 positions:

Full	7,8 m (25.6 ft)
Partial	6,0 m (19.6 ft)
	4,4 m (14.3 ft)
Retracted	2,8 m (9.1 ft)

Independent horizontal and vertical movement controlled from each side of carrier and from the operator's cab. Electronic crane level indicator with automatic leveling system.



Transmission

Allison 4000 SP. 6 speeds forward, 1 reverse
2 speed transfer case



Drive/steer

10x6x10



Axles

1st axle line – steer
2nd axle line – steer (optional drive)
3rd axle line – drive/steer (permanent drive with 10x6, disconnects for highway with 10x8)
4th axle line – drive/steer (connects for all wheel steer)
5th axle line – drive/steer
Drive axles with planetary hub reduction and center mounted differential-gearing. Inter-axle and cross axle differential locks.



Suspension

Grove exclusive MEGATRAK™ suspension. Independent hydro-pneumatic system acting on all wheels with hydraulic lockout. Suspension can be raised 160 mm (6.3 in) or lowered 120 mm (4.7 in) both longitudinally and transversely. Features an automatic leveling system for highway travel.

Specifications

Carrier continued

Tires

10 tires, 16.00R25 (445/95 R25)
(Vehicle width - 3,0 m [9.8 ft])

Steering

Dual circuit, hydraulic power assisted steering system. Transfer case mounted, ground driven emergency steering pump. Axles 1, 2, 3 and 5 steer on highway (steer by wire). Separate steering of the 4th and 5th axles for all wheel and crab steering, controlled by an electronic rocker switch.

Engine - North American version

Cummins QSX15, 6-cylinder
Horsepower: 399 KW (535 bhp) at 2100 rpm
Torque: 2539 Nm (1873 ft/lb) at 1400 rpm: EPA/
Engine Emissions: EPA/CARB/EUROMOT (off road)

*Engine

*Alternate engine: Mercedes Benz OM 502 LA, 8 cylinder
Horsepower: 420 kW (563 bhp) at 1800 rpm
Torque: 2700 Nm (1991 ft/lb) at 1300 rpm
Engine Emissions: EPA/CARB/EUROMOT (off road)

Fuel tank capacity

360 L (95 gal)

Brakes

Service brakes: pneumatic dual circuit acting on all wheels air dryer. Parking brake: pneumatically operated spring loaded brake acting on axle lines 2,3,4 and 5.

Cab

Two-man aluminum construction with the following features: safety glass, driver seat with pneumatic suspension, engine-dependent hot water heater, heated rear view mirrors, complete instrumentation and driving controls.

Electrical system

24V system with three phase alternator, 28V/100A
2 batteries, 12V/170 Ah

Maximum speed

85 km/h (53 mph)

Gradeability (theoretical)

50% - 14.00 tires
45% - 16.00/20.5 tires

Miscellaneous standard equipment

Work light; tool kit; fire extinguishers; auxiliary boom nose; radio/CD player in carrier cab, heated rear view mirrors, wind speed indicator, working light for each outrigger beam.

*Optional equipment

- ▶ Stainless steel exhaust system with spark arrestor
- ▶ Air conditioning
- ▶ 14.00R25 (385/95 R25) tires (vehicle width 3,0 m [9.8 ft])
- ▶ 20.5R25 (525/80 R25) tires (vehicle width 3,1 m [10.2 ft])
- ▶ 10x8x10 drive/steer
- ▶ Transmission retarder (in lieu of engine compression brake)
- ▶ Engine independent diesel cab heater, with engine pre-heater, including 24 hour timer
- ▶ Engine independent propane gas cab heater
- ▶ Engine shutdown valve (for both engines)
- ▶ Reversing camera system
- ▶ Wireless remote control
- ▶ Rear mounted stowage box
- ▶ Outrigger pad load indicator
- ▶ Trailer hitch
- ▶ Steel outrigger pads
- ▶ Strobe light
- ▶ Spare tire

Dimensions

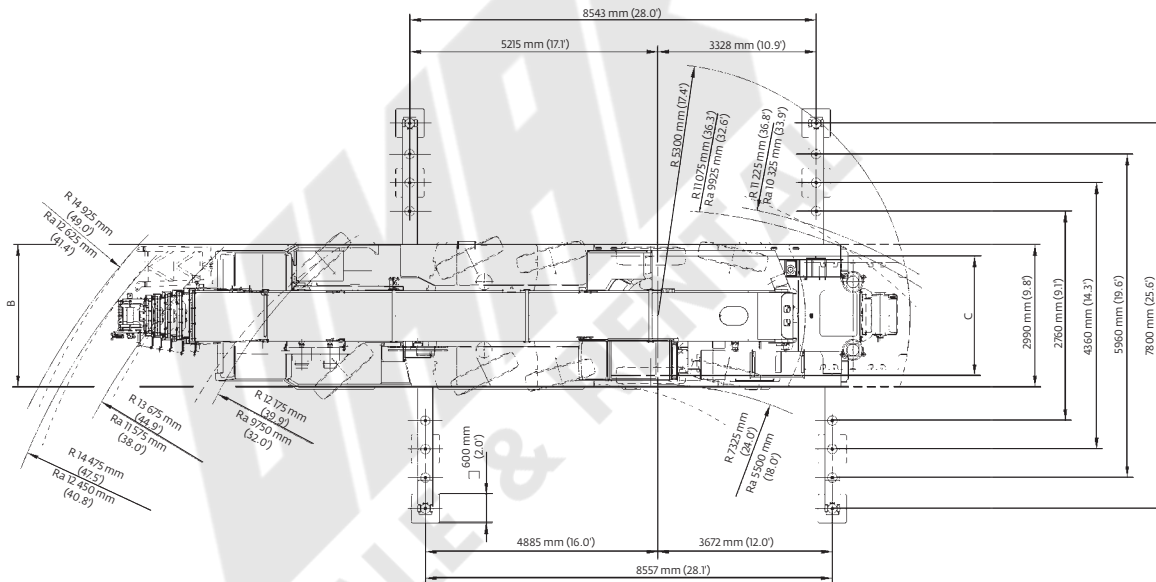
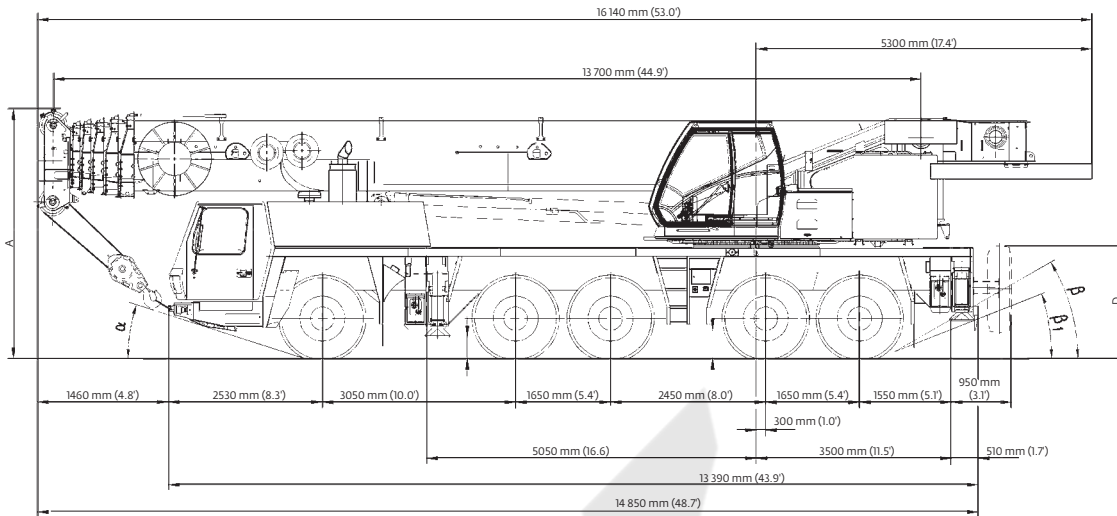

	A	A 130 mm (5.4")*	B	C	D	E	F	α	β	β_1
14.00 R25	3950 mm (13.0')	3820 mm (12.5')	3000 mm (9.8')	2548 mm (8.4')	1760 mm (5.8')	400 mm (1.3')	244 mm (.08')	18°	23°	17°
16.00 R25	4000 mm (13.1')	3870 mm (12.7')	3000 mm (9.8')	2486 mm (8.2')	1810 mm (5.9')	450 mm (1.5')	295 mm (1.0')	20°	25°	19°
20.5 R25	4000 mm (13.1')	3870 mm (12.7')	3110 mm (10.2')	2507 mm (8.2')	1810 mm (5.9')	450 mm (1.5')	295 mm (1.0')	20°	25°	19°

Ra = Radius all wheels steered
*Lowered

Weight proposals - Cummins

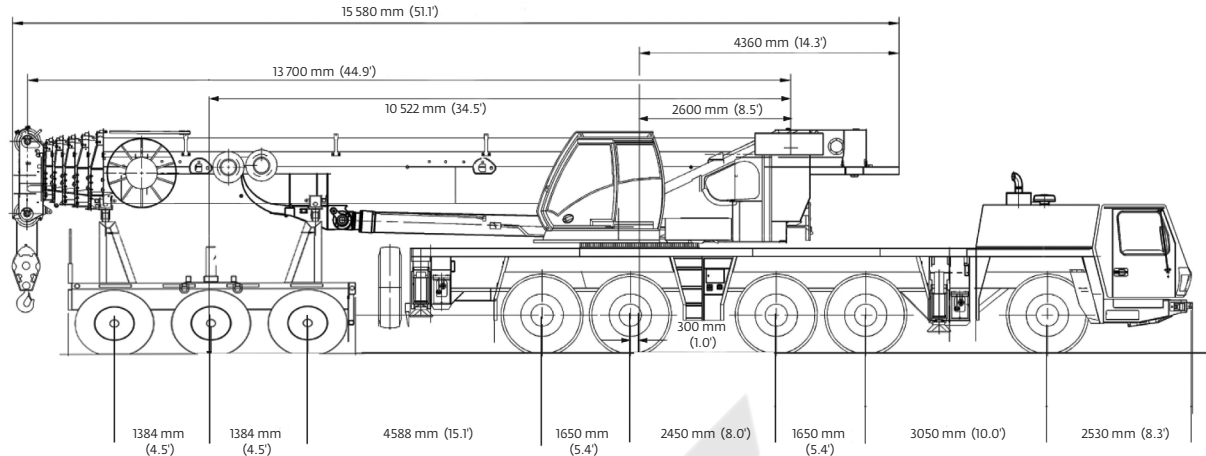

Basic weights - kg (lb)	Axles 1 - 3		Axles 4 and 5		3 Dolly axles		Total	
GMK 5225 Cummins power with: 20.50R25 tires, 10x8x10 drive/steer, 36 ft - 59 ft hydraulic luffing swingaway, 2nd oil cooler, outrigger pads, auxiliary hoist, driver and tanks filled, 3 axle boom dolly 4128 kg (9100 lb).	30 787	(67,874)	17 521	(38,627)	17 554	(38,700)	65 862	(145,201)
Additions:								
5000 kg (11,000 lb) section pinned to superstructure (special counterweight version)	4845	(10,681)	155	(342)	0	(0)	5000	(11,023)
11 000 kg (24,250 lb) base section stowed on carrier	10 659	(23,499)	341	(752)	0	(0)	11 000	(24,251)
Removals:								
Brackets for hydraulic swingaway	-15	(-33)	-7	(-15)	-64	(-141)	-86	(-190)
Hose reel + parts for hydraulic swingaway	-56	(-123)	-25	(-55)	-129	(-284)	-210	(-463)
11 m - 18 m (36 ft - 59 ft) hydraulic swingaway	-206	(-454)	-92	(-203)	-1185	(-2612)	-1483	(-3269)
Front outriggers	-2016	(-4445)	256	(564)	0	(0)	-1760	(-3880)
Rear outriggers	926	(2041)	-3029	(-6678)	0	(0)	-2103	(-4636)
Front and rear outrigger floats	-70	(-154)	-130	(-287)	0	(0)	-200	(-441)
Substitutions:								
10x6x10 drive/steer	-337	(-743)	-38	(-84)	0	(0)	-375	(-827)
14.00R25 tires	-730	(-1609)	-300	(-661)	0	(0)	-1030	(-2271)
16.00R25 tires	-305	(-672)	-125	(-276)	0	(0)	-430	(-948)

Boom over front (Cummins)								
Basic weights - kg (lb)	Axles 1 - 3		Axles 4 and 5		Total			
Cummins power, 16.00R25 tires, 10x6x10 drive/steer, 2nd oil cooler, outrigger pads, auxiliary hoist, driver and tanks filled	34 422	(75,888)	24 731	(54,523)	59 153	(130,410)		
Additions:								
10x8x10 drive/steer	337	(743)	38	(84)	375	(827)		
Transmission integrated retarder	52	(115)	-12	(-26)	40	(88)		
Spare wheel 14.00 R25 XGC steel rim with stowage	-134	(-295)	373	(822)	239	(527)		
Spare wheel 16.00 R25 XGC steel rim with stowage	-166	(-366)	461	(1016)	295	(650)		
Spare wheel 20.5 R25 XGC steel rim with stowage	-192	(-423)	534	(1177)	342	(754)		
Brackets for hydraulic swingaway	101	(223)	-15	(-33)	86	(190)		
Hose reel + parts for hydraulic swingaway	195	(430)	15	(33)	210	(463)		
11 m - 18 m (36 ft - 59 ft) hydraulic swingaway	1906	(4202)	-423	(-933)	1483	(3269)		
11 000 kg (24,250 lb) base plate stowed on carrier	10 660	(23,501)	340	(750)	11 000	(24,251)		
5000 kg (11,000 lb) slab fixed to turntable (special counterweight version)	-2759	(-6083)	7759	(17,106)	5000	(11,023)		
Substitutions:								
14.00R25 tires	-361	(-796)	-241	(-531)	-602	(-1327)		
20.5R25 tires	257	(567)	172	(379)	429	(946)		
Removals:								
Boom assembly w/o lift cylinder	-17 659	(-38,931)	-964	(-2125)	-18 622	(-41,054)		
Front outriggers	-2016	(-4445)	256	(564)	-1760	(-3880)		
Rear outriggers	926	(2041)	-3029	(-6678)	-2103	(-4636)		
Front and rear outrigger floats	70	(154)	130	(287)	200	(441)		

Weight proposals - Mercedes

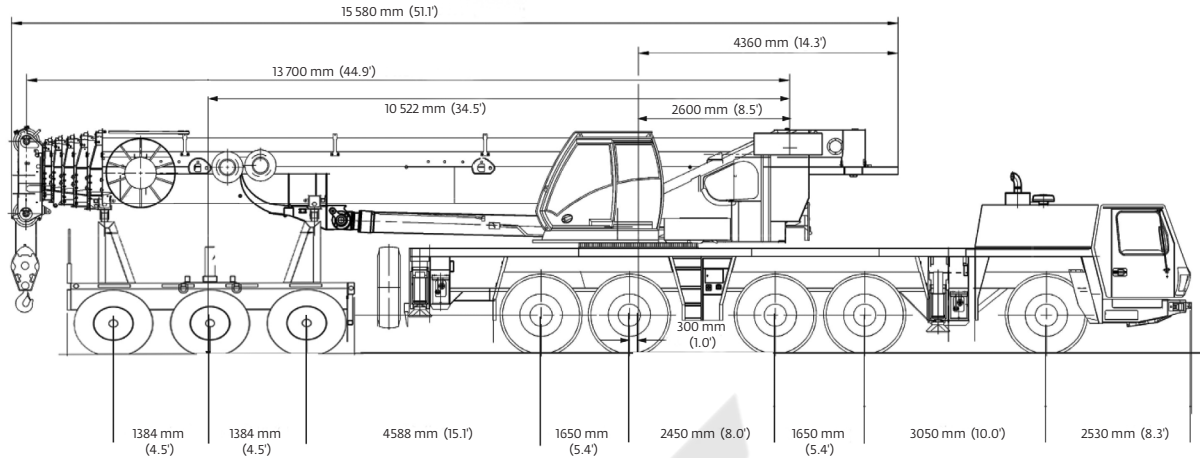

Basic weights - kg (lb)	Axles 1 - 3		Axles 4 and 5		3 Dolly axles		Total	
GMK 5225 Mercedes power with: 20.50R25 tires, 10x8x10 drive/steer, 36 ft - 59 ft hydraulic luffing swingaway, 2nd oil cooler, outrigger pads, auxiliary hoist, driver and tanks filled, 3 axle boom dolly 4128 kg (9100 lb)	29 954	(66,037)	17 751	(39,134)	17 554	(38,700)	65 260	(143,874)
Additions:								
5000 kg (11 000 lb) section pinned to superstructure (special counterweight version)	4845	(10,681)	155	(342)	0	(0)	5000	(11,023)
11 000 kg (24,250 lb) base section stowed on carrier	10 659	(23,499)	341	(752)	0	(0)	11 000	(24,251)
Removals:								
Brackets for hydraulic swingaway	- 15	(-33)	- 7	(-15)	- 64	(-141)	- 86	(-190)
Hose reel + parts for hydraulic swingaway	- 56	(-123)	- 25	(-55)	- 129	(-284)	- 210	(-463)
11 m - 18 m (36 ft - 59 ft) hydraulic swingaway	- 206	(-454)	- 92	(-203)	- 1185	(-2612)	- 1483	(-3269)
Front outriggers	-2016	(-4445)	256	(564)	0	(0)	-1760	(-3880)
Rear outriggers	926	(2041)	-3029	(-6678)	0	(0)	-2103	(-4636)
Front and rear outrigger floats	- 70	(-154)	- 130	(-287)	0	(0)	- 200	(-441)
Substitutions:								
10x6x10 drive/steer	- 337	(-743)	- 38	(-84)	0	(0)	- 375	(-827)
14.00R25 tires	- 730	(-1609)	- 300	(-661)	0	(0)	- 1030	(-2271)
16.00R25 tires	- 305	(-672)	- 125	(-276)	0	(0)	- 430	(-948)

Boom over front (Mercedes)								
Basic weights-kg (lb)	Axles 1 - 3		Axles 4 and 5				Total	
Mercedes power, 16.00R25 tires, 10x6x10 drive/steer, 2nd oil cooler, outrigger pads, auxiliary hoist, driver and tanks filled	33 330	(73,480)	25 220	(55,601)			58 551	(129,083)
Additions:								
10x8x10 drive/steer	337	(743)	38	(84)			375	(827)
Transmission integrated retarder	52	(115)	- 12	(-26)			40	(88)
Spare wheel 14.00 R25 XGC steel rim with stowage	- 134	(-295)	373	(822)			239	(527)
Spare wheel 16.00 R25 XGC steel rim with stowage	- 166	(-366)	461	(1016)			295	(650)
Spare wheel 20.5 R25 XGC steel rim with stowage	- 192	(-423)	534	(1177)			342	(754)
Brackets for hydraulic swingaway	101	(223)	- 15	(-33)			86	(190)
Hose reel + parts for hydraulic swingaway	195	(430)	15	(33)			210	(463)
11 m-18 m (36 ft - 59 ft) hydraulic swingaway	1906	(4202)	- 423	(-933)			1483	(3269)
11 000 kg (24,250 lb) base plate stowed on carrier	10 660	(23,501)	340	(750)			11 000	(24,251)
5000 kg (11,000 lb) slab fixed to turntable (special counterweight version)	-2759	(-6083)	7759	(17,106)			5000	(11,023)
Substitutions:								
14.00R25 tires	- 361	(-796)	- 241	(-531)			- 602	(-1327)
20.5R25 tires	257	(567)	172	(379)			429	(946)
Removals:								
Boom assembly w/o lift cylinder	-17 659	(-38,931)	- 964	(-2125)			- 18 622	(-41,054)
Front outriggers	-2016	(-4445)	256	(564)			-1760	(-3880)
Rear outriggers	926	(2041)	-3029	(-6678)			-2103	(-4636)
Front and rear outrigger floats	70	(154)	130	(287)			200	(441)

Counterweight

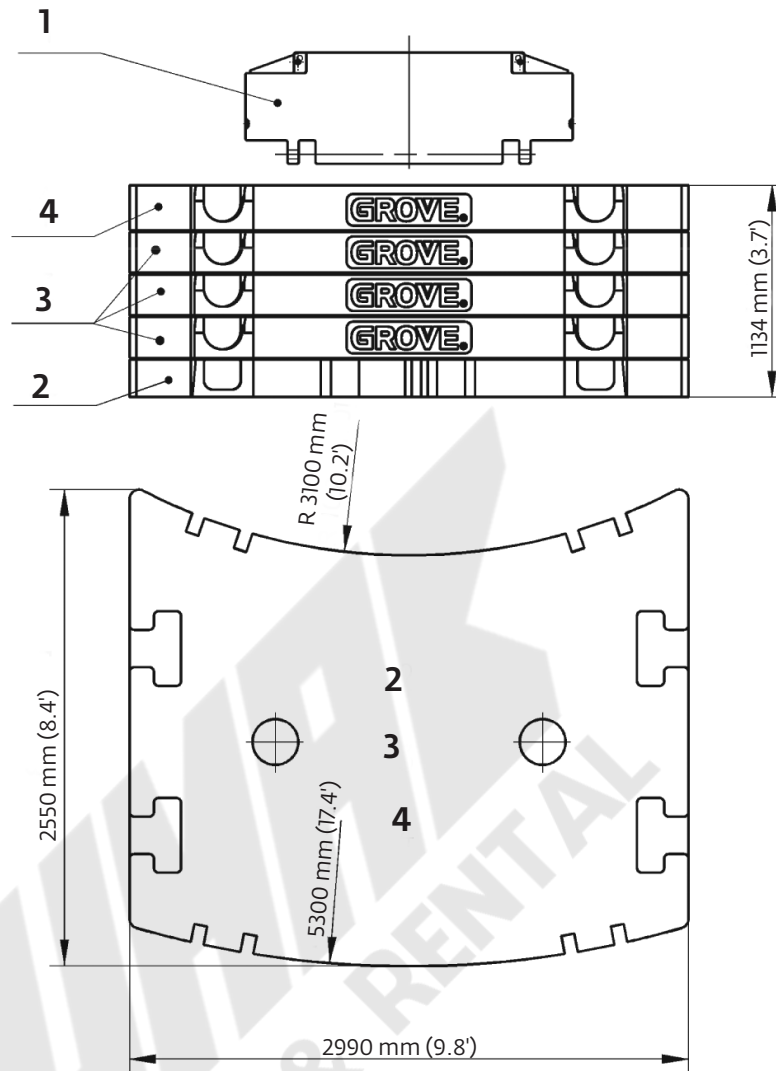

1. 2000 kg (4409 lb) Bolted (Auxiliary Hoist or IPO)
2. 11 000 kg (24,251 lb) Baseplate
3. 10 000 kg (22,046 lb) Stacking
4. 10 000 kg (22,046 lb) Stacking

	1	2	3	4
Counterweight Configuration kg (lb)				
2000 (4409)	●			
13 000 (28,660)	●	●		
23 000 (50,706)	●	●	●	
33 000 (72,753)	●	●	2●	
43 000 (94,799)	●	●	3●	
53 000 (116,845)	●	●	3●	●

Working range

13,7 m - 64 m (45 ft - 210 ft) main boom

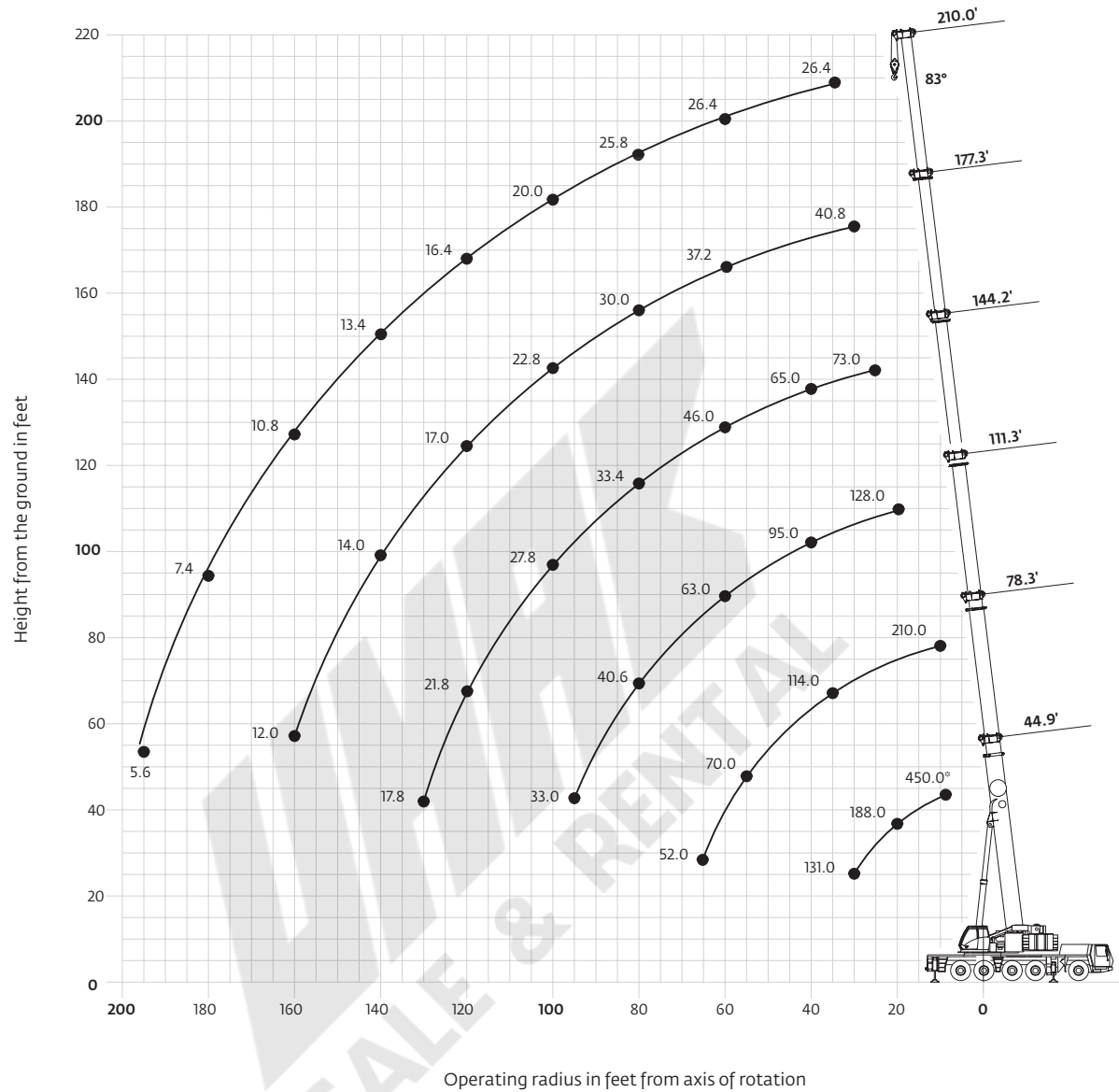

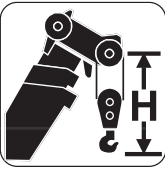





	Hook block (USt)	H
	200D	3650 mm (12.0 ft)
160D	3650 mm (12.0 ft)	
125D	3300 mm (10.8 ft)	
80D	3300 mm (10.8 ft)	
32E	3200 mm (10.5 ft)	
12 H/B	2450 mm (8.0 ft)	

*Over rear







Hook heights shown in the working range diagram do not consider loaded boom deflection.

Load charts

Main boom

 13,7 m - 64 m (44.9 ft - 210 ft)  53 100 kg (117,800 lb)  28.1 ft x 25.6 ft spread (100%)  360°											
  Pounds x 1000											
Feet	44.9	61.7	78.3	94.8	111.3	127.5	144.2	160.8	177.3	193.8	210.0
8.0	450.0*										
9.0	310.0*										
10.0	286.0	236.0	210.0	172.0							
15.0	234.0	217.0	189.0	169.0	128.0						
20.0	188.0	188.0	171.0	153.0	128.0	97.0	73.0				
25.0	157.0	159.0	153.0	142.0	126.0	97.0	73.0	55.0			
30.0	131.0	135.0	132.0	131.0	115.0	93.0	73.0	55.0	40.8	32.2	
35.0		117.0	114.0	115.0	105.0	87.0	71.0	54.0	40.8	32.2	26.4
40.0		103.0	100.0	101.0	95.0	80.0	65.0	53.0	40.8	32.2	26.4
45.0		88.0	90.0	89.0	88.0	75.0	59.0	51.0	40.8	32.2	26.4
50.0			79.0	78.0	80.0	70.0	54.0	48.0	40.2	32.2	26.4
55.0			70.0	68.0	70.0	66.0	50.0	45.0	39.0	32.2	26.4
60.0			62.0	60.0	63.0	61.0	46.0	42.0	37.2	32.2	26.4
65.0			52.0	55.0	56.0	57.0	41.6	39.4	35.4	31.2	26.4
70.0				51.0	49.0	51.0	38.8	36.8	33.8	30.0	26.4
75.0				46.0	44.0	46.0	36.0	34.2	32.0	28.8	26.4
80.0					40.6	41.8	33.4	32.0	30.0	27.6	25.8
85.0					38.4	37.8	31.6	29.8	28.0	26.6	24.4
90.0					36.2	34.4	30.2	28.0	26.2	25.2	23.0
95.0					33.0	31.2	29.0	26.2	24.6	23.8	21.4
100.0						28.4	27.8	24.6	22.8	22.0	20.0
105.0						26.0	26.6	23.2	20.4	19.8	19.0
110.0						23.8	25.6	21.4	19.2	18.6	18.2
115.0							23.6	19.8	18.2	17.6	17.2
120.0							21.8	18.2	17.0	16.6	16.4
125.0							20.0	16.8	16.2	15.6	15.6
130.0							17.8	16.2	15.2	14.8	14.8
135.0								15.6	14.6	14.0	14.0
140.0								15.2	14.0	13.2	13.4
145.0									13.4	12.6	12.6
150.0									13.0	11.6	12.0
155.0									12.6	11.0	11.4
160.0									12.0	10.4	10.8
165.0										10.0	9.8
170.0										9.6	9.0
175.0										9.2	8.2
180.0											7.4
185.0											6.8
190.0											6.2
195.0											5.6

* Over the rear with special equipment

 13,7 m - 64 m (44.9 ft - 210 ft)  43 100 kg (95,000 lb)  28.1 ft x 25.6 ft spread (100%)  360°											
  Pounds x 1000											
Feet	44.9	61.7	78.3	94.8	111.3	127.5	144.2	160.8	177.3	193.8	210.0
10.0	286.0	236.0	210.0	172.0							
15.0	230.0	217.0	189.0	169.0	128.0						
20.0	185.0	186.0	171.0	153.0	128.0	97.0	73.0				
25.0	154.0	155.0	152.0	142.0	126.0	97.0	73.0	55.0			
30.0	131.0	132.0	129.0	131.0	115.0	93.0	73.0	55.0	40.8	32.2	
35.0	157.0	114.0	111.0	112.0	105.0	87.0	71.0	54.0	40.8	32.2	26.4
40.0	131.0	97.0	97.0	94.0	93.0	80.0	65.0	53.0	40.8	32.2	26.4
45.0		83.0	83.0	80.0	79.0	75.0	59.0	51.0	40.8	32.2	26.4
50.0			71.0	70.0	68.0	68.0	54.0	48.0	40.2	32.2	26.4
55.0			63.0	63.0	59.0	60.0	50.0	45.0	39.0	32.2	26.4
60.0			56.0	55.0	54.0	53.0	46.0	42.0	37.2	32.2	26.4
65.0			49.0	48.0	50.0	48.0	41.6	39.4	35.4	31.2	26.4
70.0				43.2	45.0	42.8	38.8	36.8	33.8	30.0	26.4
75.0				40.4	40.4	38.6	35.6	34.2	32.0	28.8	26.4
80.0					36.4	34.6	33.2	31.2	30.0	27.6	25.8
85.0					32.8	31.0	31.6	28.2	28.0	26.6	24.4
90.0					29.8	28.0	29.6	25.6	25.6	25.2	23.0
95.0					27.0	26.2	27.0	23.2	23.4	23.6	21.4
100.0						25.2	24.6	21.4	21.2	21.6	20.0
105.0						24.0	22.4	19.6	19.4	19.8	19.0
110.0						22.2	20.4	18.8	18.0	18.0	18.2
115.0							18.6	18.2	17.2	16.6	17.2
120.0							17.0	17.4	16.6	15.4	15.8
125.0							15.6	16.4	15.8	14.6	14.6
130.0							14.6	15.2	15.2	13.8	13.4
135.0								14.0	14.0	13.2	12.2
140.0								12.8	13.0	12.4	11.2
145.0									11.8	11.4	10.0
150.0									11.0	10.4	9.0
155.0									10.0	9.4	8.2
160.0									9.2	8.6	7.4
165.0										7.8	6.6
170.0										7.0	5.8
175.0										6.4	5.0
180.0											4.4
185.0											3.8
190.0											3.2
195.0											2.8

THIS CHART IS ONLY A GUIDE AND SHOULD NOT BE USED TO OPERATE THE CRANE.

The individual crane's load chart, operating instructions and other instructional plates must be read and understood prior to operating the crane

Load charts

Main boom

13,7 m - 64 m (44.9 ft - 210 ft)
 33 100 kg (72,900 lb)
 28.1 ft x 25.6 ft spread (100%)
 360°

Pounds x 1000

Feet	44.9	61.7	78.3	94.8	111.3	127.5	144.2	160.8	177.3	193.8	210.0
10.0	286.0	236.0	210.0	172.0							
15.0	224.0	217.0	189.0	169.0	128.0						
20.0	181.0	182.0	171.0	153.0	128.0	97.0	73.0				
25.0	151.0	152.0	149.0	142.0	126.0	97.0	73.0	55.0			
30.0	125.0	127.0	125.0	117.0	114.0	93.0	73.0	55.0	40.8	32.2	
35.0		105.0	102.0	94.0	92.0	87.0	71.0	54.0	40.8	32.2	26.4
40.0		84.0	84.0	82.0	76.0	76.0	65.0	53.0	40.8	32.2	26.4
45.0		69.0	73.0	70.0	70.0	65.0	59.0	51.0	40.8	32.2	26.4
50.0			61.0	60.0	60.0	56.0	52.0	48.0	40.2	32.2	26.4
55.0			53.0	54.0	53.0	49.0	45.0	43.8	39.0	32.2	26.4
60.0			45.0	48.0	47.0	43.0	41.8	38.6	37.2	32.2	26.4
65.0			39.6	42.6	41.6	38.2	38.8	34.0	33.8	31.2	26.4
70.0				37.6	36.6	34.0	34.8	30.2	30.0	30.0	26.4
75.0				33.6	32.6	32.0	31.4	27.8	27.6	27.0	26.4
80.0					29.0	30.2	28.4	26.4	26.0	25.4	24.8
85.0					26.0	27.8	25.6	25.0	24.6	23.6	22.4
90.0					23.8	25.2	23.2	23.6	23.2	22.0	20.2
95.0						22.8	20.8	21.6	21.2	20.2	18.2
100.0							18.8	19.8	19.4	18.4	16.6
105.0							18.8	17.8	17.8	16.8	15.0
110.0							17.2	16.4	16.4	15.4	13.6
115.0								16.2	15.6	14.8	12.2
120.0								15.0	14.8	13.8	11.2
125.0								13.6	13.6	12.8	10.0
130.0								12.6	12.4	11.6	9.0
135.0									11.4	10.6	8.0
140.0									10.4	9.6	7.2
145.0										8.6	6.2
150.0										7.8	5.4
155.0										7.0	4.6
160.0										6.2	3.8
165.0											3.2
170.0											2.6
175.0											2.0

13,7 m - 64 m (44.9 ft - 210 ft)
 23 100 kg (50,900 lb)
 28.1 ft x 25.6 ft spread (100%)
 360°

Pounds x 1000

Feet	44.9	61.7	78.3	94.8	111.3	127.5	144.2	160.8	177.3	193.8	210.0
10.0	284.0	236.0	210.0	172.0							
15.0	220.0	217.0	189.0	169.0	128.0						
20.0	177.0	178.0	171.0	153.0	128.0	97.0	73.0				
25.0	142.0	144.0	137.0	124.0	119.0	97.0	73.0	55.0			
30.0	109.0	111.0	103.0	100.0	91.0	90.0	73.0	55.0	40.8	32.2	
35.0		88.0	86.0	80.0	79.0	73.0	67.0	54.0	40.8	32.2	26.4
40.0		70.0	70.0	69.0	66.0	60.0	56.0	53.0	40.8	32.2	26.4
45.0		59.0	58.0	59.0	56.0	51.0	51.0	45.0	40.8	32.2	26.4
50.0			50.0	51.0	48.0	44.0	44.0	38.6	38.0	32.2	26.4
55.0			44.0	44.0	41.4	40.8	38.4	35.2	35.2	32.2	26.4
60.0			37.8	38.2	36.2	37.0	33.6	33.0	33.0	31.4	26.4
65.0			33.0	33.2	31.8	32.8	29.6	29.8	29.2	27.8	25.6
70.0				29.0	29.4	29.2	27.2	27.4	26.8	24.6	22.6
75.0				25.6	27.6	26.2	25.6	25.4	24.0	22.0	20.0
80.0					24.6	23.6	23.8	23.0	21.6	19.6	17.8
85.0					22.0	21.0	21.4	20.8	19.4	17.6	15.8
90.0					19.8	18.6	19.4	18.8	17.4	15.8	14.0
95.0						17.8	17.6	17.0	15.8	14.2	12.4
100.0							16.8	16.2	15.4	14.2	11.0
105.0							15.0	14.6	14.0	12.8	9.6
110.0								13.6	13.2	12.6	8.4
115.0									11.8	11.2	7.4
120.0									10.8	10.2	6.4
125.0									9.6	9.0	5.4
130.0									8.8	8.0	4.6
135.0										7.2	3.8
140.0										6.4	3.2
145.0										4.8	2.4
150.0										4.0	3.0
155.0										3.4	2.4
160.0										2.8	

Load charts

Main boom

13,7 m - 64 m
(44.9 ft - 210 ft)

13 100 kg
(28,800 lb)

28.1 ft x 25.6 ft spread
(100%)



360°

  Pounds x 1000

Feet	44.9	61.7	78.3	94.8	111.3	127.5	144.2	160.8	177.3	193.8	210.0
10.0	278.0	236.0	210.0	172.0							
15.0	216.0	215.0	189.0	169.0	128.0						
20.0	168.0	170.0	153.0	136.0	126.0	97.0	73.0				
25.0	120.0	120.0	111.0	101.0	98.0	89.0	73.0	55.0			
30.0	83.0	88.0	83.0	82.0	75.0	69.0	64.0	55.0	40.8	32.2	
35.0		69.0	66.0	65.0	60.0	57.0	55.0	48.0	40.8	32.2	26.4
40.0		54.0	56.0	53.0	50.0	50.0	45.0	43.8	38.6	32.2	26.4
45.0		44.0	47.0	45.0	41.8	42.0	38.2	38.6	37.0	31.6	26.4
50.0			38.8	38.0	38.6	35.8	35.4	34.0	32.0	29.6	26.4
55.0			32.6	32.6	33.4	31.0	30.8	29.6	27.8	25.4	23.2
60.0			28.4	29.2	29.2	28.4	26.8	25.8	24.2	22.0	19.8
65.0			24.2	26.2	25.6	25.6	23.6	22.6	21.2	19.2	17.2
70.0				22.8	22.6	22.8	20.8	20.0	18.6	16.8	14.8
75.0				20.0	19.8	20.2	18.4	17.6	16.4	14.6	12.6
80.0					18.0	18.0	16.4	15.6	14.4	14.6	10.8
85.0					15.8	16.0	14.6	13.8	12.6	11.0	9.2
90.0					14.0	14.2	13.0	12.4	11.2	9.6	7.8
95.0					12.4	12.4	11.4	11.0	9.8	8.2	6.6
100.0						11.0	10.0	9.6	8.6	7.0	5.4
105.0						9.8	8.8	8.6	7.4	6.0	4.4
110.0						8.6	7.6	7.4	6.4	5.0	3.4
115.0							6.6	6.4	5.4	4.0	2.4
120.0							5.6	5.4	4.6	3.2	
125.0							4.8	4.6	3.8	2.4	
130.0							4.0	3.8	3.0		
135.0								3.2	2.4		
140.0								2.4			

13,7 m - 64 m
(44.9 ft - 210 ft)

2100 kg
(4600 lb)

28.1 ft x 25.6 ft spread
(100%)

360°

  Pounds x 1000

Feet	44.9	61.7	78.3	94.8	111.3	127.5	144.2	160.8	177.3	193.8	210.0
10.0	272.0	236.0	210.0	172.0							
15.0	206.0	206.0	185.0	156.0	128.0						
20.0	134.0	124.0	112.0	105.0	95.0	84.0	73.0				
25.0	83.0	85.0	81.0	75.0	68.0	66.0	59.0	51.0			
30.0	56.0	61.0	60.0	56.0	56.0	51.0	49.0	44.0	38.6	32.2	
35.0		47.0	47.0	46.0	44.0	43.0	40.2	37.4	34.8	31.6	26.4
40.0		36.0	38.0	38.0	35.8	35.2	33.0	30.8	28.4	25.8	23.0
45.0		28.2	31.0	31.4	30.4	29.4	27.6	25.6	23.6	21.2	18.6
50.0			25.6	26.2	25.6	24.8	23.2	21.4	19.8	17.6	15.2
55.0			21.0	22.2	21.8	21.0	19.6	18.0	16.6	14.6	12.4
60.0			17.2	18.8	18.6	18.0	16.8	15.4	13.8	12.0	10.0
65.0			14.2	16.0	16.0	15.4	14.4	13.0	11.6	9.8	8.0
70.0				13.4	13.6	13.2	12.2	11.0	9.8	8.0	6.2
75.0				11.4	11.8	11.4	10.4	9.2	8.0	6.4	4.6
80.0					10.0	9.8	8.8	7.8	6.6	5.0	3.4
85.0					8.4	8.4	7.4	6.4	5.4	3.8	2.2
90.0					7.0	7.2	6.4	5.2	4.2	2.8	
95.0					5.8	6.0	5.2	4.2	3.2		
100.0						4.8	4.2	3.2	2.2		
105.0						3.8	3.4	2.4			
110.0						3.0	2.6				

THIS CHART IS ONLY A GUIDE AND SHOULD NOT BE USED TO OPERATE THE CRANE.

The individual crane's load chart, operating instructions and other instructional plates must be read and understood prior to operating the crane

Working range

64 m (210 ft) main boom, 11 m - 18 m (36 ft - 59 ft) swingaway and 2 X 8 m (26 ft) inserts

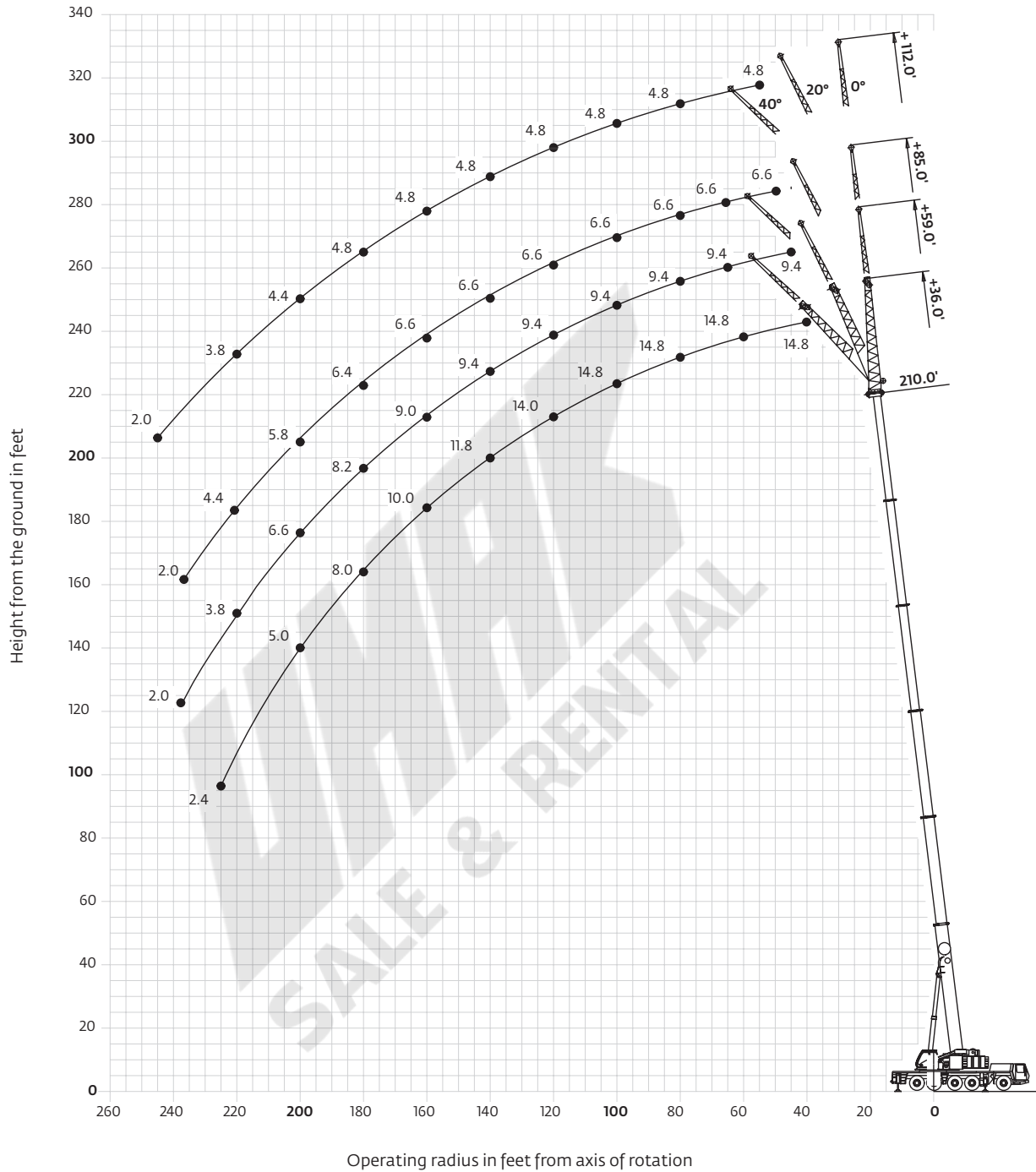

Hook heights shown in the working range diagram do not consider loaded boom deflection.

THIS CHART IS ONLY A GUIDE AND SHOULD NOT BE USED TO OPERATE THE CRANE.

Load charts

Hydraulic offsettable swingaway

Intermediate angle



64 m
(210 ft)



11-18-26-34 m
(36-59-85-112 ft)



53 100 kg
(117,000 lb)



28.1 ft x 25.6 ft spread
(100%)



360°



Pounds x 1000

Feet	210' + 36'			210' + 59'			223' + 85'			223' + 112'		
	0°	0° - 20°	20° - 40°	0°	0° - 20°	20° - 40°	0°	0° - 20°	20° - 40°	0°	0° - 20°	20° - 40°
40.0	14.8			9.4								
45.0	14.8			9.4								
50.0	14.8	14.8		9.4			6.6					
55.0	14.8	14.8	14.8	9.4	9.4		6.6			4.8		
60.0	14.8	14.8	14.8	9.4	9.4		6.6			4.8		
65.0	14.8	14.8	14.8	9.4	9.4		6.6			4.8		
70.0	14.8	14.8	14.8	9.4	9.4		6.6	6.6		4.8		
75.0	14.8	14.8	14.8	9.4	9.4	9.4	6.6	6.6		4.8	4.8	
80.0	14.8	14.8	14.8	9.4	9.4	9.4	6.6	6.6	6.2	4.8	4.8	
85.0	14.8	14.8	14.8	9.4	9.4	9.4	6.6	6.6	6.2	4.8	4.8	
90.0	14.8	14.8	14.8	9.4	9.4	9.4	6.6	6.6	6.2	4.8	4.8	3.6
95.0	14.8	14.8	14.8	9.4	9.4	9.4	6.6	6.6	6.2	4.8	4.8	3.6
100.0	14.8	14.8	14.8	9.4	9.4	9.2	6.6	6.6	6.2	4.8	4.8	3.6
105.0	14.8	14.8	14.8	9.4	9.4	9.2	6.6	6.6	6.2	4.8	4.8	3.6
110.0	14.8	14.4	14.2	9.4	9.4	9.2	6.6	6.6	6.2	4.8	4.8	3.4
115.0	14.6	14.0	13.8	9.4	9.4	9.2	6.6	6.6	6.2	4.8	4.8	3.4
120.0	14.0	13.6	13.4	9.4	9.4	9.2	6.6	6.6	6.2	4.8	4.8	3.4
125.0	13.2	13.2	13.0	9.4	9.4	9.0	6.6	6.6	6.2	4.8	4.8	3.4
130.0	12.6	12.6	12.6	9.4	9.4	9.0	6.6	6.6	6.2	4.8	4.8	3.4
135.0	12.0	12.2	12.2	9.4	9.4	9.0	6.6	6.6	6.2	4.8	4.8	3.4
140.0	11.6	11.8	11.8	9.4	9.2	8.8	6.6	6.6	6.2	4.8	4.8	3.4
145.0	11.0	11.2	11.4	9.4	9.2	8.8	6.6	6.6	6.2	4.8	4.8	3.4
150.0	10.6	10.8	11.0	9.4	9.2	8.8	6.6	6.6	6.2	4.8	4.8	3.4
155.0	10.0	10.2	10.6	9.4	9.0	8.8	6.6	6.6	6.2	4.8	4.8	3.4
160.0	9.6	9.8	10.0	9.0	8.8	8.8	6.6	6.6	6.2	4.8	4.8	3.4
165.0	9.2	9.4	9.6	8.8	8.6	8.6	6.6	6.6	6.2	4.8	4.8	3.4
170.0	8.8	9.0	9.2	8.4	8.4	8.4	6.6	6.6	6.2	4.8	4.8	3.4
175.0	8.2	8.4	8.8	8.0	8.2	8.4	6.6	6.6	6.2	4.8	4.8	3.4
180.0	7.6	7.6	8.0	7.6	8.0	8.2	6.4	6.4	6.2	4.8	4.8	3.4
185.0	6.8	6.8		7.4	7.6	8.0	6.2	6.2	6.2	4.8	4.8	3.4
190.0	6.2	6.2		7.0	7.2	7.6	6.0	6.0	6.2	4.8	4.8	3.4
195.0	5.6	5.6		6.4	6.4	7.4	5.8	5.8	6.0	4.6	4.6	3.4
200.0	5.0	5.0		5.8	5.8	6.6	5.6	5.8	5.8	4.4	4.4	3.4
205.0	4.4	4.4		5.2	5.2		5.4	5.4	5.8	4.2	4.4	3.4
210.0	3.8	3.8		4.8	4.8		4.8	4.8	5.6	4.0	4.2	3.4
215.0	3.4	3.4		4.2	4.2		4.2	4.2	5.0	4.0	4.0	3.4
220.0	2.8	2.8		3.8	3.8		3.8	3.8	4.4	3.8	3.8	3.4
225.0	2.4			3.2	3.2		3.4	3.4		3.2	3.2	3.4
230.0				2.8	2.8		2.8	2.8		2.8	2.8	3.4
235.0				2.4	2.4		2.4	2.4		2.4	2.4	3.0
240.0				2.0	2.0		2.0	2.0		2.0	2.0	2.6

THIS CHART IS ONLY A GUIDE AND SHOULD NOT BE USED TO OPERATE THE CRANE.

The individual crane's load chart, operating instructions and other instructional plates must be read and understood prior to operating the crane.

Load charts

Hydraulic offsettable swingaway

Loads for luffing



64 m
(210 ft)



11-18-26-34 m
(36-59-85-112 ft)



53 100 kg
(117,000 lb)



28.1 ft x 25.6 ft spread
(100%)



360°



Pounds x 1000

Feet	210' + 36'		210' + 59'		223' + 85'		223' + 112'	
	0° - 20°	20° - 40°	0° - 20°	20° - 40°	0° - 20°	20° - 40°	0° - 20°	20° - 40°
50.0	14.8							
55.0	14.8	14.6	9.4					
60.0	14.8	14.6	9.4					
65.0	14.8	14.6	9.4					
70.0	14.8	14.6	9.4					
75.0	14.8	14.6	9.4	9.0	6.6		4.8	
80.0	14.8	14.6	9.2	9.0	6.6	5.8	4.8	
85.0	14.8	14.6	9.2	9.0	6.6	5.8	4.8	
90.0	14.8	14.6	9.2	9.0	6.6	5.8	4.8	3.4
95.0	14.8	14.6	9.2	8.8	6.6	5.8	4.8	3.4
100.0	14.6	14.4	9.2	8.8	6.6	5.8	4.8	3.4
105.0	14.2	14.0	9.2	8.8	6.6	5.8	4.8	3.4
110.0	13.8	13.6	9.2	8.8	6.6	5.8	4.8	3.4
115.0	13.2	13.2	9.0	8.8	6.6	5.8	4.8	3.4
120.0	12.8	12.8	9.0	8.6	6.6	5.8	4.8	3.4
125.0	12.4	12.4	9.0	8.6	6.6	5.8	4.8	3.4
130.0	12.0	12.0	9.0	8.6	6.6	5.8	4.8	3.4
135.0	11.6	11.6	8.8	8.6	6.6	5.8	4.8	3.4
140.0	11.2	11.2	8.8	8.4	6.6	5.8	4.8	3.4
145.0	10.6	11.0	8.8	8.4	6.6	5.8	4.8	3.4
150.0	10.2	10.6	8.6	8.4	6.6	5.8	4.8	3.4
155.0	9.8	10.0	8.6	8.2	6.6	5.8	4.8	3.4
160.0	9.4	9.6	8.4	8.2	6.6	5.8	4.8	3.4
165.0	9.0	9.2	8.2	8.2	6.6	5.8	4.8	3.4
170.0	8.4	8.8	8.0	8.0	6.6	5.8	4.8	3.4
175.0	7.6	8.2	7.8	8.0	6.4	5.8	4.8	3.4
180.0	7.0	7.4	7.6	7.8	6.2	5.8	4.8	3.4
185.0	6.4		7.2	7.6	6.0	5.8	4.8	3.4
190.0	5.8		6.6	7.2	5.8	5.8	4.6	3.4
195.0	5.2		6.0	6.8	5.6	5.8	4.4	3.4
200.0	4.6		5.4	6.2	5.4	5.6	4.2	3.4
205.0	4.2		5.0		5.0	5.4	4.2	3.4
210.0	3.6		4.4		4.6	5.2	4.0	3.4
215.0	3.2		4.0		4.0	4.8	3.8	3.4
220.0	2.8		3.6		3.6	4.2	3.6	3.4
225.0			3.2		3.2		3.2	3.4
230.0			2.8		2.8		2.8	3.4
235.0			2.4		2.4		2.4	3.0
240.0			2.0		2.0		2.0	2.6

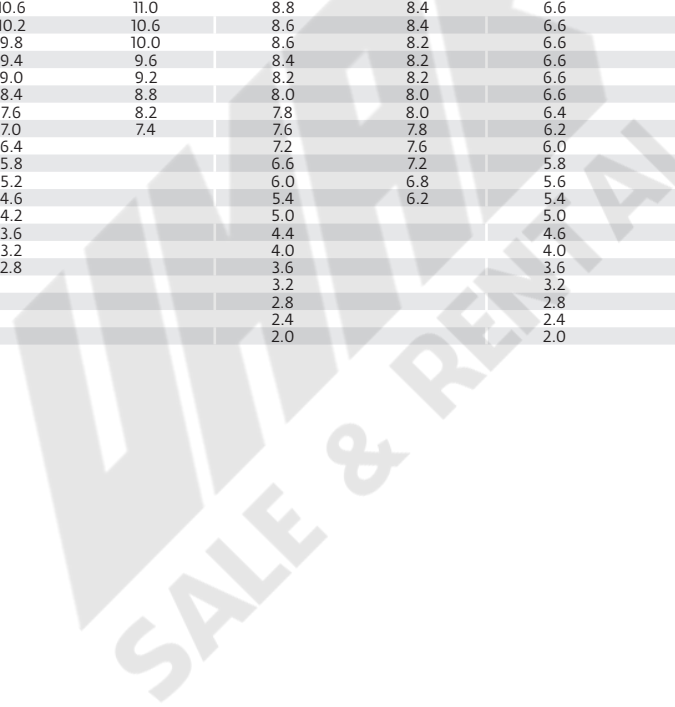

THIS CHART IS ONLY A GUIDE AND SHOULD NOT BE USED TO OPERATE THE CRANE.

Load charts

Hydraulic offsettable swingaway

Intermediate angle

 64 m
(210 ft)

 11-18-26-34 m
(36-59-85-112 ft)

 23 100 kg
(50,900 lb)

 28.1 ft x 25.6 ft spread
(100%)

 360°



Pounds x 1000

Feet	210' + 36'			210' + 59'			223' + 85'			223' + 112'		
	0°	0° - 20°	20° - 40°	0°	0° - 20°	20° - 40°	0°	0° - 20°	20° - 40°	0°	0° - 20°	20° - 40°
40.0	14.8			9.4								
45.0	14.8			9.4								
50.0	14.8	14.8		9.4			6.6					
55.0	14.8	14.8	14.8	9.4	9.4		6.6			4.8		
60.0	14.8	14.8	14.8	9.4	9.4		6.6			4.8		
65.0	14.8	14.8	14.8	9.4	9.4		6.6			4.8		
70.0	14.8	14.8	14.8	9.4	9.4		6.6	6.6		4.8		
75.0	14.8	14.8	14.8	9.4	9.4	9.4	6.6	6.6		4.8	4.8	
80.0	14.8	14.8	14.8	9.4	9.4	9.4	6.6	6.6	6.2	4.8	4.8	
85.0	14.8	14.8	14.8	9.4	9.4	9.4	6.6	6.6	6.2	4.8	4.8	
90.0	13.4	13.4	14.8	9.4	9.4	9.4	6.6	6.6	6.2	4.8	4.8	3.6
95.0	11.8	11.8	13.2	9.4	9.4	9.4	6.6	6.6	6.2	4.8	4.8	3.6
100.0	10.4	10.4	11.8	9.4	9.4	9.2	6.6	6.6	6.2	4.8	4.8	3.6
105.0	9.2	9.2	10.4	9.4	9.4	9.2	6.6	6.6	6.2	4.8	4.8	3.6
110.0	8.0	8.0	9.2	8.6	8.6	9.2	6.6	6.6	6.2	4.8	4.8	3.4
115.0	7.0	7.0	8.0	7.6	7.6	9.2	6.6	6.6	6.2	4.8	4.8	3.4
120.0	6.0	6.0	7.0	6.6	6.6	8.4	6.4	6.4	6.2	4.8	4.8	3.4
125.0	5.2	5.2	6.0	5.8	5.8	7.6	5.6	5.6	6.2	4.8	4.8	3.4
130.0	4.4	4.4	5.2	5.0	5.0	6.6	4.8	4.8	6.2	4.6	4.6	3.4
135.0	3.6	3.6	4.4	4.2	4.2	5.8	4.0	4.0	5.6	3.8	3.8	3.4
140.0	2.8	2.8	3.6	3.6	3.6	5.0	3.4	3.4	4.8	3.2	3.2	3.4
145.0	2.2	2.2	3.0	3.0	3.0	4.2	2.8	2.8	4.2	2.4	2.4	3.4
150.0			2.2	2.4	2.4	3.6	2.2	2.2	3.4	2.0	2.0	3.4
155.0						3.0			2.8			2.6
160.0						2.4			2.2			2.0

Loads for luffing

 64 m
(210 ft)

 11-18-26-34 m
(36-59-85-112 ft)

 23 100 kg
(50,900 lb)

 28.1 ft x 25.6 ft spread
(100%)

 360°



Pounds x 1000

Feet	210' + 36'		210' + 59'		223' + 85'		223' + 112'	
	0° - 20°	20° - 40°	0° - 20°	20° - 40°	0° - 20°	20° - 40°	0° - 20°	20° - 40°
50.0	14.8		9.4					
55.0	14.8	14.6	9.4					
60.0	14.8	14.6	9.4					
65.0	14.8	14.6	9.4					
70.0	14.8	14.6	9.4		6.6			
75.0	14.8	14.6	9.4	9.0	6.6		4.8	
80.0	14.8	14.6	9.2	9.0	6.6	5.8	4.8	
85.0	14.8	14.6	9.2	9.0	6.6	5.8	4.8	
90.0	13.4	14.6	9.2	9.0	6.6	5.8	4.8	3.4
95.0	11.8	13.2	9.2	8.8	6.6	5.8	4.8	3.4
100.0	10.4	11.8	9.2	8.8	6.6	5.8	4.8	3.4
105.0	9.2	10.4	9.2	8.8	6.6	5.8	4.8	3.4
110.0	8.0	9.2	8.6	8.8	6.6	5.8	4.8	3.4
115.0	7.0	8.0	7.6	8.8	6.6	5.8	4.8	3.4
120.0	6.0	7.0	6.6	8.4	6.4	5.8	4.8	3.4
125.0	5.2	6.0	5.8	7.6	5.6	5.8	4.8	3.4
130.0	4.4	5.2	5.0	6.6	4.8	5.8	4.6	3.4
135.0	3.6	4.4	4.2	5.8	4.0	5.6	3.8	3.4
140.0	2.8	3.6	3.6	5.0	3.4	4.8	3.2	3.4
145.0	2.2	3.0	3.0	4.2	2.8	4.2	2.4	3.4
150.0		2.2	2.4	3.6	2.2	3.4	2.0	3.4
155.0				3.0		2.8		2.6
160.0				2.4		2.2		2.0



THIS CHART IS ONLY A GUIDE AND SHOULD NOT BE USED TO OPERATE THE CRANE.

The individual crane's load chart, operating instructions and other instructional plates must be read and understood prior to operating the crane.

Load charts



Manual offsettable swingaway

 **64 m**
(210 ft)
 **11-18-26-34 m**
(36-59-85-112 ft)
 **53 100 kg**
(117,000 lb)
 **28.1 ft x 25.6 ft spread**
(100%)
 **360°**

  **Pounds x 1000**

Feet	210' + 36'			210' + 59'			223' + 85'			223' + 112'		
	0°	20°	40°	0°	20°	40°	0°	20°	40°	0°	20°	40°
40.0	14.8											
45.0	14.8			9.4								
50.0	14.8	14.8		9.4			6.6					
55.0	14.8	14.8	14.8	9.4			6.6			4.8		
60.0	14.8	14.8	14.8	9.4	9.4		6.6			4.8		
65.0	14.8	14.8	14.8	9.4	9.4		6.6			4.8		
70.0	14.8	14.8	14.8	9.4	9.4		6.6	6.6		4.8		
75.0	14.8	14.8	14.8	9.4	9.4	9.4	6.6	6.6		4.8	4.8	
80.0	14.8	14.8	14.8	9.4	9.4	9.4	6.6	6.6	6.2	4.8	4.8	
85.0	14.8	14.8	14.8	9.4	9.4	9.4	6.6	6.6	6.2	4.8	4.8	
90.0	14.8	14.8	14.8	9.4	9.4	9.4	6.6	6.6	6.2	4.8	4.8	3.6
95.0	14.8	14.8	14.8	9.4	9.4	9.4	6.6	6.6	6.2	4.8	4.8	3.6
100.0	14.8	14.8	14.8	9.4	9.4	9.2	6.6	6.6	6.2	4.8	4.8	3.6
105.0	14.8	14.8	14.8	9.4	9.4	9.2	6.6	6.6	6.2	4.8	4.8	3.6
110.0	14.8	14.4	14.2	9.4	9.4	9.2	6.6	6.6	6.2	4.8	4.8	3.4
115.0	14.6	14.0	13.8	9.4	9.4	9.2	6.6	6.6	6.2	4.8	4.8	3.4
120.0	14.0	13.6	13.4	9.4	9.4	9.2	6.6	6.6	6.2	4.8	4.8	3.4
125.0	13.2	13.2	13.0	9.4	9.4	9.0	6.6	6.6	6.2	4.8	4.8	3.4
130.0	12.6	12.6	12.6	9.4	9.4	9.0	6.6	6.6	6.2	4.8	4.8	3.4
135.0	12.0	12.2	12.2	9.4	9.4	9.0	6.6	6.6	6.2	4.8	4.8	3.4
140.0	11.6	11.8	11.8	9.4	9.2	8.8	6.6	6.6	6.2	4.8	4.8	3.4
145.0	11.0	11.2	11.4	9.4	9.2	8.8	6.6	6.6	6.2	4.8	4.8	3.4
150.0	10.6	10.8	11.0	9.4	9.2	8.8	6.6	6.6	6.2	4.8	4.8	3.4
155.0	10.0	10.2	10.6	9.4	9.0	8.8	6.6	6.6	6.2	4.8	4.8	3.4
160.0	9.6	9.8	10.0	9.0	8.8	8.8	6.6	6.6	6.2	4.8	4.8	3.4
165.0	9.2	9.4	9.6	8.8	8.6	8.6	6.6	6.6	6.2	4.8	4.8	3.4
170.0	8.8	9.0	9.2	8.4	8.4	8.4	6.6	6.6	6.2	4.8	4.8	3.4
175.0	8.2	8.6	8.8	8.0	8.2	8.4	6.6	6.6	6.2	4.8	4.8	3.4
180.0	7.6	8.0	8.2	7.6	8.0	8.2	6.4	6.4	6.2	4.8	4.8	3.4
185.0	6.8	7.2	7.4	7.4	7.6	8.0	6.2	6.2	6.2	4.8	4.8	3.4
190.0	6.2	6.6	7.0	7.4	7.6	7.6	6.0	6.0	6.2	4.8	4.8	3.4
195.0	5.6	5.8	6.4	7.0	7.4	7.4	5.8	5.8	6.0	4.6	4.6	3.4
200.0	5.0	5.2	5.8	6.6	7.0	7.0	5.6	5.8	5.8	4.4	4.4	3.4
205.0	4.4	4.6	5.2	6.0	6.0	6.0	5.4	5.6	5.8	4.2	4.4	3.4
210.0	3.8	4.0	4.8	5.4	5.4	5.4	4.8	5.4	5.6	4.0	4.2	3.4
215.0	3.4	3.6	4.2	4.8	4.8	4.8	4.2	5.0	5.4	4.0	4.0	3.4
220.0	2.8	3.0	3.8	4.2	4.2	4.2	3.8	4.4	4.8	3.8	3.8	3.4
225.0	2.4		3.2	3.8	3.8	3.8	3.4	3.4		3.2	3.8	3.4
230.0			2.8	3.2	3.2	3.2	2.8	3.0		2.8	3.6	3.4
235.0			2.4	2.8	2.8	2.8	2.4	2.6		2.4	3.0	3.4
240.0			2.0	2.4	2.4	2.4	2.0	2.2		2.0	2.6	2.8
245.0											2.2	

 **64 m**
(210 ft)
 **11-18-26-34 m**
(36-59-85-112 ft)
 **23 100 kg**
(50,900 lb)
 **28.1 ft x 25.6 ft spread**
(100%)
 **360°**

  **Pounds x 1000**

Feet	210' + 36'			210' + 59'			223' + 85'			223' + 112'		
	0°	20°	40°	0°	20°	40°	0°	20°	40°	0°	20°	40°
40.0	14.8											
45.0	14.8			9.4								
50.0	14.8	14.8		9.4			6.6					
55.0	14.8	14.8	14.8	9.4	9.4		6.6			4.8		
60.0	14.8	14.8	14.8	9.4	9.4		6.6			4.8		
65.0	14.8	14.8	14.8	9.4	9.4		6.6			4.8		
70.0	14.8	14.8	14.8	9.4	9.4		6.6	6.6		4.8		
75.0	14.8	14.8	14.8	9.4	9.4	9.4	6.6	6.6		4.8	4.8	
80.0	14.8	14.8	14.8	9.4	9.4	9.4	6.6	6.6	6.2	4.8	4.8	
85.0	14.8	14.8	14.8	9.4	9.4	9.4	6.6	6.6	6.2	4.8	4.8	
90.0	13.4	14.8	14.8	9.4	9.4	9.4	6.6	6.6	6.2	4.8	4.8	3.6
95.0	11.8	13.2	14.4	9.4	9.4	9.4	6.6	6.6	6.2	4.8	4.8	3.6
100.0	10.4	11.8	12.8	9.4	9.4	9.2	6.6	6.6	6.2	4.8	4.8	3.6
105.0	9.2	10.4	11.4	9.4	9.4	9.2	6.6	6.6	6.2	4.8	4.8	3.6
110.0	8.0	9.2	10.0	8.6	9.4	9.2	6.6	6.6	6.2	4.8	4.8	3.4
115.0	7.0	8.0	8.8	7.6	9.4	9.2	6.6	6.6	6.2	4.8	4.8	3.4
120.0	6.0	7.0	7.8	6.6	8.4	9.2	6.4	6.6	6.2	4.8	4.8	3.4
125.0	5.2	6.0	6.8	5.8	7.6	8.8	5.6	6.6	6.2	4.8	4.8	3.4
130.0	4.4	5.2	5.8	5.0	6.6	7.8	4.8	6.4	6.2	4.6	4.8	3.4
135.0	3.6	4.4	5.0	4.2	5.8	7.0	4.0	5.6	6.2	3.8	4.8	3.4
140.0	2.8	3.6	4.2	3.6	5.0	6.0	3.4	4.8	6.0	3.2	4.6	3.4
145.0	2.2	3.0	3.4	3.0	4.2	5.2	2.8	4.2	5.2	2.4	4.0	3.4
150.0		2.2	2.6	2.4	3.6	4.6	2.2	3.4	4.6	2.0	3.4	3.4
155.0			2.0		3.0	3.8		2.8	3.8		2.6	3.4
160.0					2.4	3.2		2.2	3.2		2.0	3.0
165.0						2.6			2.6			2.4
170.0						2.0			2.0			

THIS CHART IS ONLY A GUIDE AND SHOULD NOT BE USED TO OPERATE THE CRANE.

Working range

13,7 m - 64 m (45 ft - 210 ft) main boom with 3,6 m (11.8 ft) heavy duty jib

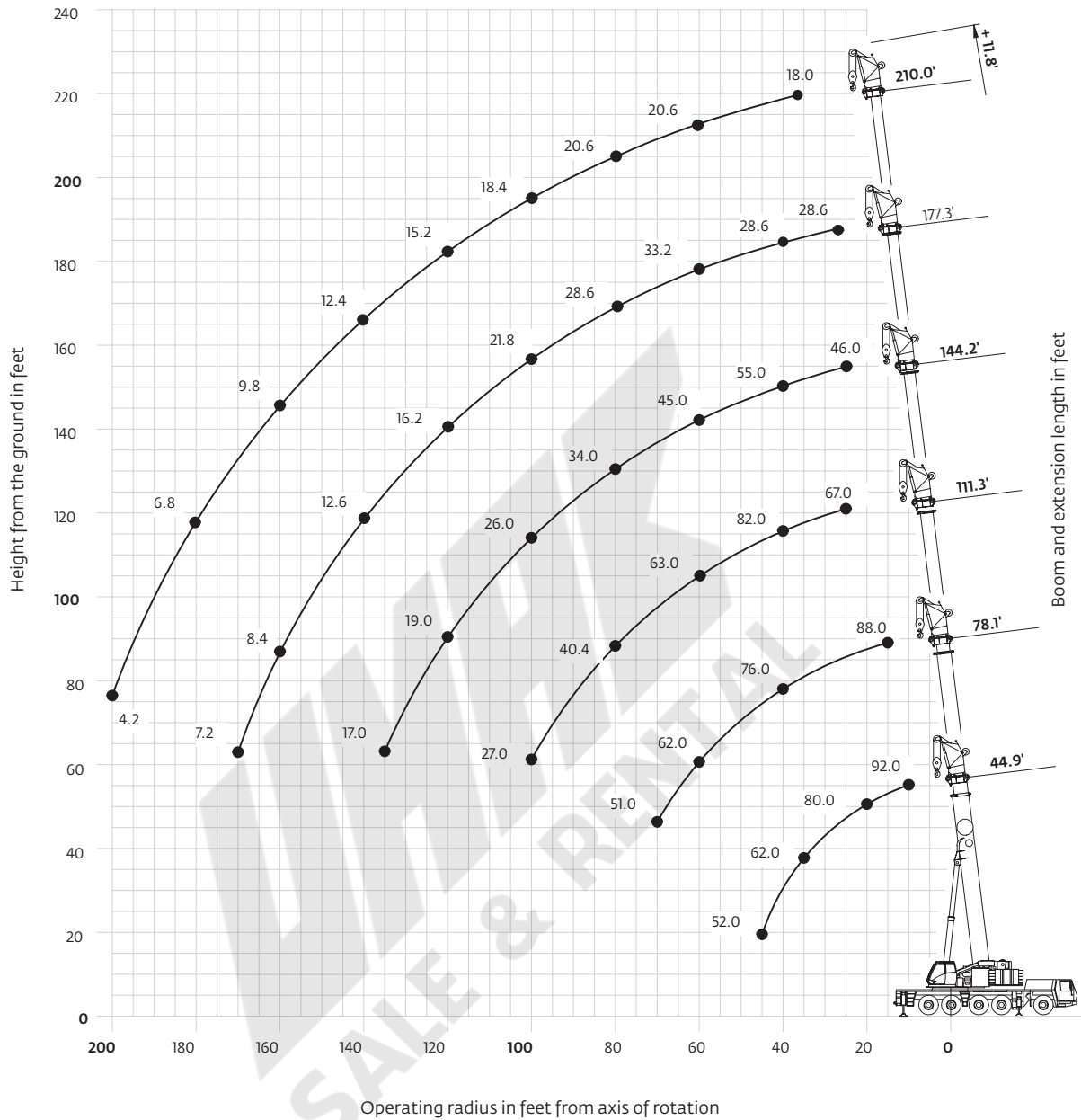

Hook heights shown in the working range diagram do not consider loaded boom deflection.





THIS CHART IS ONLY A GUIDE AND SHOULD NOT BE USED TO OPERATE THE CRANE.

The individual crane's load chart, operating instructions and other instructional plates must be read and understood prior to operating the crane.



Load charts

Integrated heavy duty jib

Intermediate angle

13,7 m - 64 m (44.9 ft - 210 ft) 3,6 m (11.8 ft) 53 100 kg (117,000 lb) 28.1 ft x 25.6 ft spread (100%) 360°

  Pounds x 1000

Feet	44.9' + 11.8'			78.1' + 11.8'			111.3' + 11.8'			144.2' + 11.8'			177.3' + 11.8'			210.0' + 11.8'		
	0°	20°	40°	0°	20°	40°	0°	20°	40°	0°	20°	40°	0°	20°	40°	0°	20°	40°
10.0	92.0	88.0	88.0															
15.0	85.0	85.0	85.0			88.0												
20.0	80.0	79.0	80.0	91.0	87.0	87.0			67.0									
25.0	72.0	73.0	75.0	87.0	85.0	85.0			67.0			46.0						
30.0	64.0	67.0	71.0	83.0	83.0	82.0	86.0	70.0	67.0			46.0			28.6			
35.0	59.0	62.0		79.0	78.0	79.0	84.0	70.0	67.0			46.0			28.6			
40.0	55.0	61.0		74.0	74.0	76.0	82.0	70.0	67.0	55.0	46.0	46.0			28.6			18.0
45.0	52.0			69.0	70.0	73.0	79.0	70.0	67.0	54.0	46.0	46.0	33.2	28.6	28.6			18.0
50.0				64.0	67.0	71.0	73.0	70.0	67.0	51.0	46.0	46.0	33.2	28.6	28.6			18.0
55.0				61.0	64.0	69.0	68.0	68.0	67.0	48.0	46.0	46.0	33.2	28.6	28.6	20.6	18.0	18.0
60.0				57.0	62.0		62.0	63.0	63.0	45.0	45.0	45.0	33.2	28.6	28.6	20.6	18.0	18.0
65.0				55.0	57.0		56.0	56.0	56.0	41.2	41.4	42.2	31.8	28.6	28.6	20.6	18.0	18.0
70.0				51.0	51.0		50.0	50.0	51.0	38.6	38.6	39.2	30.6	28.6	28.6	20.6	18.0	18.0
75.0							45.0	45.0	46.0	35.8	36.0	36.4	29.2	28.6	28.6	20.6	18.0	18.0
80.0							40.2	40.4	40.4	33.4	33.6	34.0	28.0	27.8	28.6	20.6	18.0	18.0
85.0							36.2	36.4	36.4	31.4	31.4	31.8	26.6	26.6	27.2	20.6	18.0	18.0
90.0							32.6	32.8		29.4	29.4	29.8	25.0	25.0	25.4	20.6	18.0	18.0
95.0							29.6	29.8		27.4	27.6	27.8	23.4	23.4	23.0	19.4	18.0	18.0
100.0							26.8	27.0		25.8	26.0	26.0	21.8	21.8	20.8	18.4	18.0	18.0
105.0										24.4	24.4	24.0	20.0	20.0	19.6	17.4	17.4	17.8
110.0										22.2	22.2	22.0	18.2	18.4	18.4	16.6	16.6	16.8
115.0										20.2	20.2		17.0	17.0	17.2	15.6	15.8	16.0
120.0										18.8	19.0		16.0	16.0	16.2	15.0	15.0	15.2
125.0										18.0	18.4		15.0	15.0	15.2	14.2	14.2	14.4
130.0										17.4	17.8		14.2	14.2	14.4	13.6	13.6	13.8
135.0										13.4	13.4		13.4	13.4		12.8	13.0	13.0
140.0										12.6	12.6		12.6	12.6		12.2	12.2	12.4
145.0										11.4	11.4		11.4	11.4		11.6	11.6	11.8
150.0										10.4	10.4		10.4	10.4		11.0	11.0	11.0
155.0										9.4	9.4		9.4	9.4		10.4	10.4	10.4
160.0										8.4	8.4		8.4	8.4		9.8	9.8	
165.0										7.6			7.6			9.2	9.2	
170.0										7.2			7.2			8.4	8.4	
175.0																7.6	7.6	
180.0																6.8	6.8	
185.0																6.2	6.2	
190.0																5.6	5.6	
195.0																4.8	4.8	
200.0																4.2		

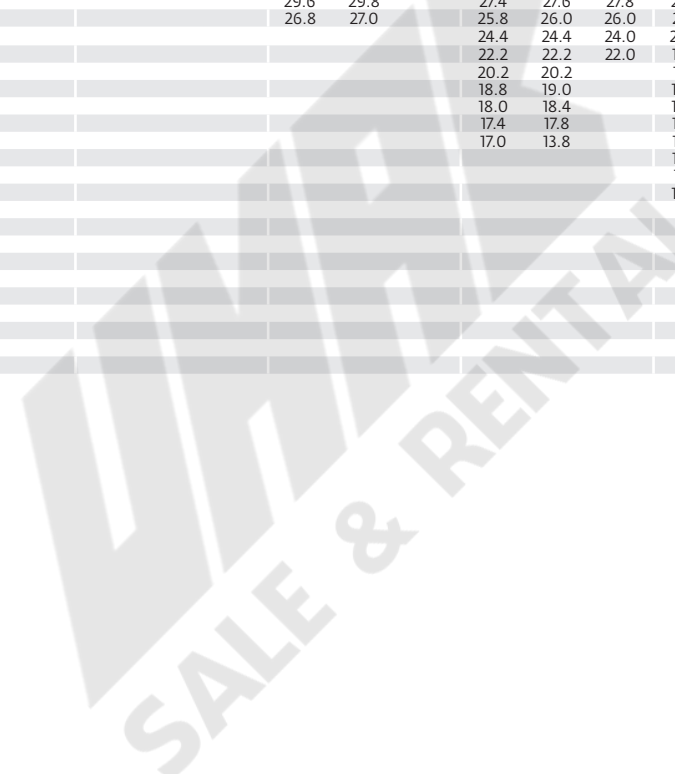

Load charts

Integrated heavy duty jib

Loads for luffing







Feet	Pounds x 1000											
	44.9' + 11.8'		78.1' + 11.8'		111.3' + 11.8'		144.2' + 11.8'		177.3' + 11.8'		210.0' + 11.8'	
	0°-20°	20°-40°	0°-20°	20°-40°	0°-20°	20°-40°	0°-20°	20°-40°	0°-20°	20°-40°	0°-20°	20°-40°
10.0	65.0	65.0										
15.0	63.0	63.0		66.0								
20.0	59.0	61.0	64.0	64.0		64.0						
25.0	56.0	61.0	63.0	63.0		64.0		43.6				
30.0	54.0	61.0	61.0	62.0	64.0	64.0		43.6		27.4		
35.0	53.0		59.0	61.0	63.0	63.0		43.6		27.4		
40.0	52.0		57.0	61.0	62.0	62.0	44.0	43.6		27.4		17.4
45.0			56.0	60.0	61.0	62.0	44.0	43.6	27.4	27.4		17.4
50.0			54.0	60.0	59.0	61.0	44.0	43.6	27.4	27.4		17.4
55.0			53.0	61.0	58.0	61.0	44.0	43.6	27.4	27.4	18.0	17.4
60.0			52.0		56.0	60.0	42.8	43.2	27.4	27.4	18.0	17.4
65.0			52.0		53.0	53.0	39.4	40.2	27.4	27.4	18.0	17.4
70.0			47.0		47.0	47.0	36.8	37.4	27.4	27.4	18.0	17.4
75.0					41.6	41.6	34.2	34.8	27.4	27.4	18.0	17.4
80.0					37.2	37.2	32.0	32.2	26.6	27.2	18.0	17.4
85.0					33.4	33.4	30.0	30.2	25.2	26.0	18.0	17.4
90.0					30.2		28.0	28.2	23.8	24.2	18.0	17.4
95.0					27.4		26.2	26.6	22.4	22.0	18.0	17.4
100.0					24.8		24.8	24.8	20.8	19.8	17.4	17.4
105.0							22.4	22.4	19.2	18.6	16.6	17.0
110.0							20.4	20.4	17.4	17.4	15.8	16.0
115.0							18.8		16.2	16.4	15.0	15.2
120.0							18.2		15.4	15.4	14.4	14.6
125.0							17.4		14.4	14.4	13.6	13.8
130.0							16.6		13.6	13.6	13.0	13.2
135.0									12.8		12.4	12.4
140.0									11.6		11.6	11.8
145.0									10.6		11.0	11.2
150.0									9.6		10.4	10.6
155.0									8.6		9.8	10.0
160.0									7.8		9.4	
165.0											8.6	
170.0											7.8	
175.0											7.2	
180.0											6.4	
185.0											5.8	
190.0											5.2	
195.0											4.6	

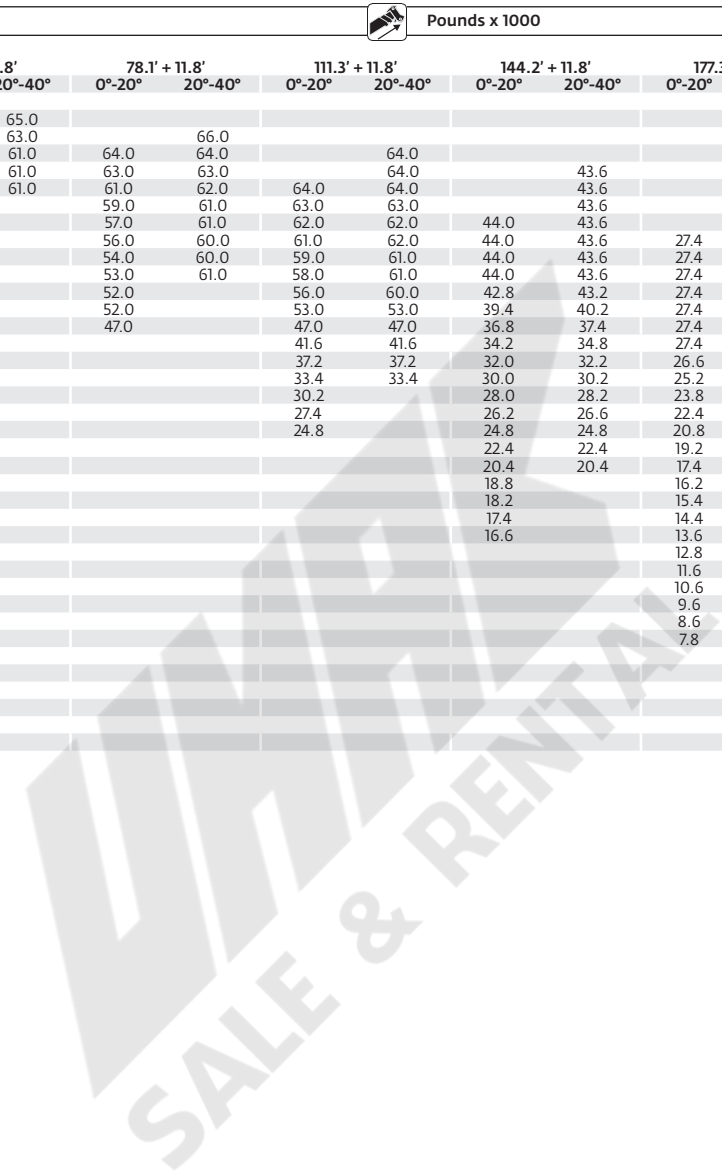

THIS CHART IS ONLY A GUIDE AND SHOULD NOT BE USED TO OPERATE THE CRANE.

The individual crane's load chart, operating instructions and other instructional plates must be read and understood prior to operating the crane.

Load charts

Integrated heavy duty jib

Intermediate angle



Pounds x 1000

Feet	44.9' + 11.8'			78.1' + 11.8'			111.3' + 11.8'			144.2' + 11.8'			177.3' + 11.8'			210.0' + 11.8'		
	0°	20°	40°	0°	20°	40°	0°	20°	40°	0°	20°	40°	0°	20°	40°	0°	20°	40°
10.0	92.0	88.0	88.0															
15.0	85.0	85.0	85.0															
20.0	80.0	79.0	80.0						67.0									
25.0	72.0	73.0	75.0	91.0	87.0	87.0			67.0			46.0						
30.0	64.0	67.0	71.0	83.0	83.0	82.0	86.0	70.0	67.0			46.0					28.6	
35.0	59.0	62.0		79.0	78.0	79.0			67.0			46.0					28.6	
40.0	55.0	61.0		66.0	66.0	67.0	60.0	60.0	60.0	55.0	46.0	46.0					28.6	18.0
45.0	52.0			56.0	56.0	56.0	50.0	50.0	51.0	46.0	46.0	46.0	33.2	28.6	28.6		28.6	18.0
50.0				47.0	47.0	48.0	42.4	42.6	43.2	40.8	40.4	41.2	33.2	28.6	28.6		28.6	18.0
55.0				40.0	40.0	40.6	36.4	36.6	37.0	37.6	37.6	38.2	31.8	28.6	28.6		20.6	18.0
60.0				36.6	37.2		31.6	31.8	32.0	33.0	33.0	33.4	28.4	27.6	28.0		20.6	18.0
65.0				34.0	34.0		27.4	27.6	27.8	29.0	29.0	29.6	27.0	24.0	24.4		20.6	18.0
70.0				30.0	30.0		24.0	24.0	24.2	25.6	25.6	26.2	25.4	22.6	22.6		20.6	18.0
75.0							21.0	21.0	21.2	22.8	22.8	23.2	22.8	22.6	22.6		19.2	18.0
80.0							18.2	18.2	18.4	20.4	20.4	20.6	20.4	20.4	20.6		17.0	17.2
85.0							15.6	15.8	15.8	18.2	18.2	18.4	18.4	18.4	18.6		15.0	15.2
90.0							14.2	14.4		16.2	16.2	16.4	16.6	16.6	16.6		13.2	13.4
95.0							13.2	13.6		14.4	14.4	14.6	14.8	14.8	15.0		11.8	11.8
100.0							12.6	12.8		12.8	12.8	13.2	13.4	13.4	13.4		10.2	10.4
105.0										11.4	11.4	8.2	12.0	12.0	12.0		9.0	9.2
110.0										9.8	9.8	6.8	10.8	10.8	10.8		7.8	8.0
115.0										8.6	8.6		9.6	9.6	9.6		6.8	6.8
120.0										7.4	7.4		8.6	8.6	8.6		5.8	5.8
125.0										6.4	6.4		7.6	7.6	7.6		4.8	4.8
130.0										5.4	5.4		6.6	6.6	6.6		4.0	4.0
135.0										4.6			5.8	5.8			3.2	3.2
140.0													4.8	4.8			2.4	2.6
145.0													4.2	4.2				
150.0													3.4	3.4				
155.0													2.8	2.8				
160.0													2.2	2.2				

Loads for luffing



































Pounds x 1000

Feet	44.9' + 11.8'		78.1' + 11.8'		111.3' + 11.8'		144.2' + 11.8'		177.3' + 11.8'		210.0' + 11.8'	
	0°-20°	20°-40°	0°-20°	20°-40°	0°-20°	20°-40°	0°-20°	20°-40°	0°-20°	20°-40°	0°-20°	20°-40°
10.0	65.0	65.0										
15.0	63.0	63.0										
20.0	59.0	61.0										
25.0	56.0	61.0										
30.0	54.0	61.0										
35.0	53.0											
40.0	52.0											
45.0												
50.0												
55.0												
60.0												
65.0												
70.0												
75.0												
80.0												
85.0												
90.0												
95.0												
100.0												
105.0												
110.0												
115.0												
120.0												
125.0												
130.0												
135.0												
140.0												
145.0												
150.0												
155.0												
160.0												

THIS CHART IS ONLY A GUIDE AND SHOULD NOT BE USED TO OPERATE THE CRANE.

Grove GMK5225 The individual crane's load chart, operating instructions and other instructional plates must be read and understood prior to operating the crane.

Symbols glossary

 Axles	 Counterweight	 Grade	 Radius
 Boom	 Drive	 Hoist	 Rotation
 Boom elevation	 Electrical system	 Hookblock	 Speed
 Boom extension	 Engine	 Hydraulic system	 Steering
 Boom length	 Extension	 Lights	 Suspension
 Boom nose	 Frame	 Oil	 Swing
 Brakes	 Fuel tank capacity	 Outrigger controls	 Tires
 Cab	 Gear	 Outriggers	 Transmission



Notes





Regional headquarters

Manitowoc - Americas

Manitowoc, Wisconsin, USA

Tel: +1 920 684 6621

Fax: +1 920 683 6277

Shady Grove, Pennsylvania, USA

Tel: +1 717 597 8121

Fax: +1 717 597 4062

Manitowoc - Europe, Middle East & Africa

Ecully, France

Tel: +33 (0)4 72 18 20 20

Fax: +33 (0)4 72 18 20 00

Manitowoc - Asia Pacific

Shanghai, China

Tel: +86 21 6457 0066

Fax: +86 21 6457 4955

Regional offices

Americas

Brazil

Alphaville

Mexico

Monterrey

Chile

Santiago

Europe, Middle East & Africa

Czech Republic

Netvorice

France

Baudemont

Cergy

Decines

Germany

Langenfeld

Hungary

Budapest

Italy

Parabiago

Netherlands

Breda

Poland

Warsaw

Portugal

Baltar

Russia

Moscow

U.A.E.

Dubai

U.K.

Gawcott

Asia - Pacific

Australia

Brisbane

Melbourne

Sydney

China

Beijing

Xi'an

India

Hyderabad

Pune

Korea

Seoul

Philippines

Makati City

Singapore

Factories

Brazil

Alphaville

China

TaiAn

Zhangjiagang

France

Charlieu

La Clayette

Moulins

Germany

Wilhelmshaven

India

Pune

Italy

Niella Tanaro

Portugal

Baltar

Fânzeres

Slovakia

Saris

USA

Manitowoc

Port Washington

Shady Grove

This document is non-contractual. Constant improvement and engineering progress make it necessary that we reserve the right to make specification, equipment, and price changes without notice. Illustrations shown may include optional equipment and accessories and may not include all standard equipment.