

# 85 TON ALL TERRAIN



NESS & CAMPBELL  
CRANE, INC.





# GMK 4085B

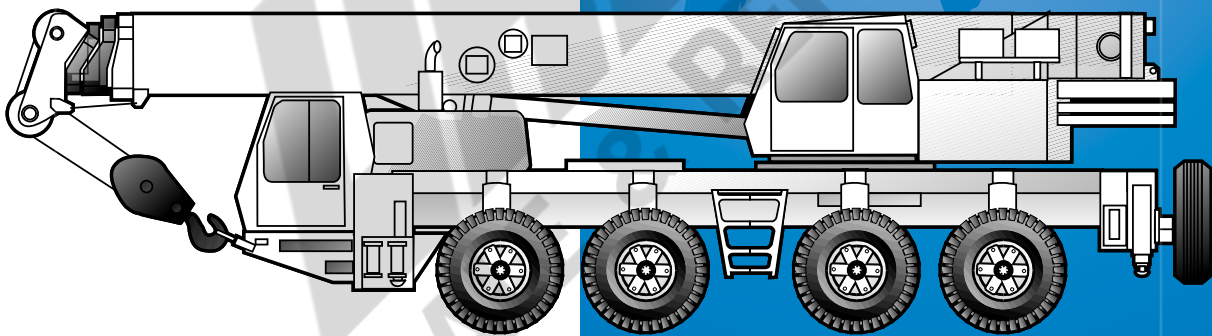

**All Terrain Hydraulic Crane**



## Dimensions

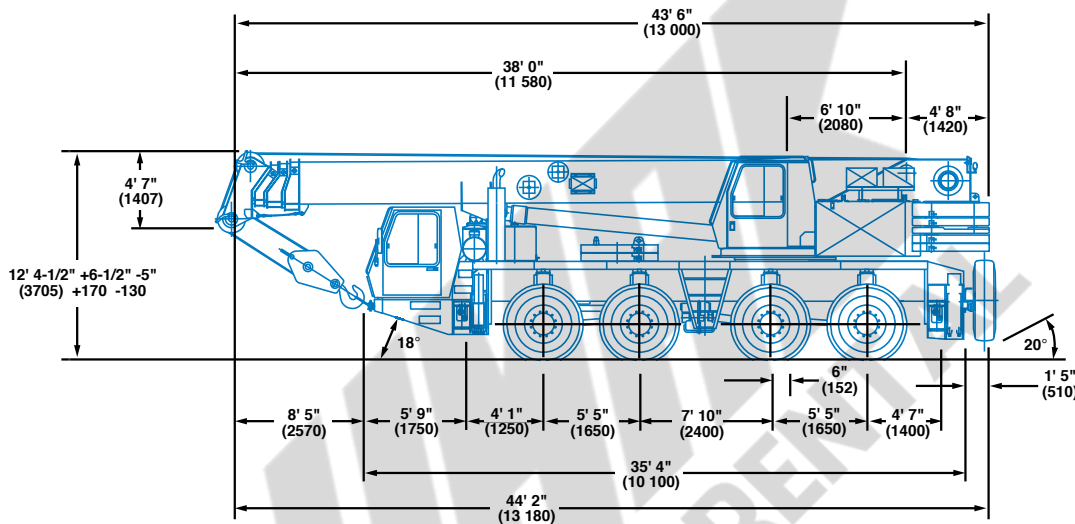
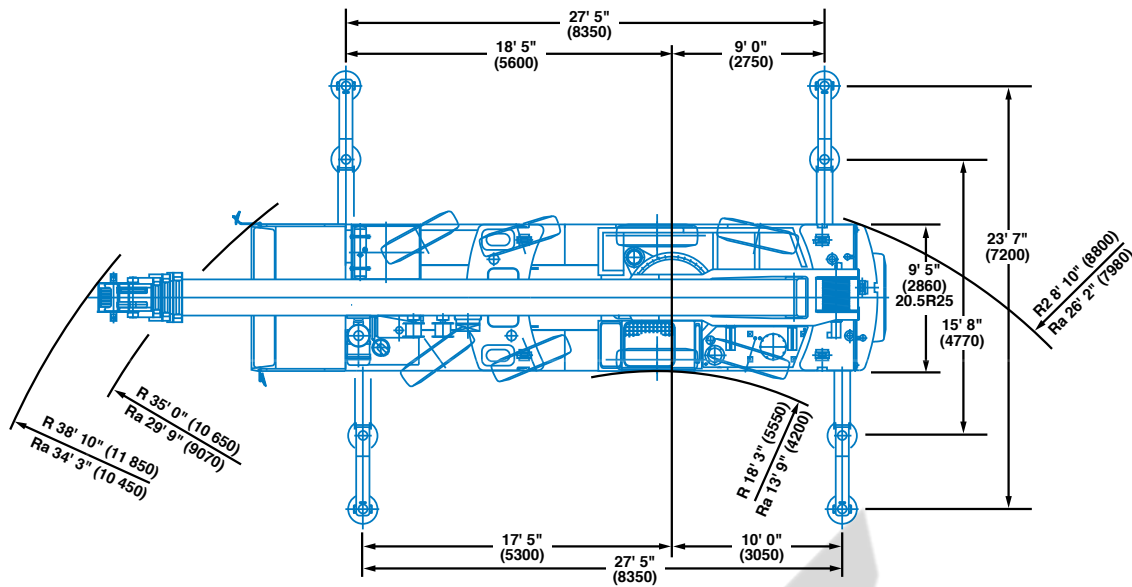

Note: ( ) Reference dimensions in mm

### Model GMK4085B equipped with:

	Front (2)	Rear (2)	Total
8 x 6 x 8 drive/steer, 20.5 R25 tires; 4,000 lbs. removable counterweight, brackets for S/A, oil cooler (Must be roaded with 4,000 lb. counterweight plate for correct weight distribution)	52,006 lbs. (2 x 26,003)	37,624 lbs. (2 x 18,812)	89,630 lbs.

### Weights for accessory equipment:

1. Lattice extension w/brackets (33 - 53 ft.) stowed on boom	+ 3,781	- 915	+ 2,866
2. Auxiliary hoist with cable	- 1,940	+ 4,585	+ 2,645
3. 16.00R25 tires in lieu of 20.5R25 tires	- 370	- 370	- 740
4. 14.00R25 tires in lieu of 20.5R25 tires	- 900	- 900	- 1,800
5. Spare tire (on rear of carrier w/carry bracket)			
14.00R25	- 415	+ 1,000	+ 585
16.00R25	- 515	+ 1,230	+ 715
20.5R25	- 590	+ 1,400	+ 810
6. Outrigger floats stowed	+ 170	+ 180	+ 350
7. 8 x 8 x 8 drive/steer	+ 215	+ 820	+ 1,035
8. 45 - ton hook block on carrier	+ 1,850	- 360	+ 1,490
9. 45 - ton hook block on bumper	+ 3,220	- 1,730	+ 1,490
10. Rooster sheave	+ 467	- 275	+ 192





38 - 125 ft.  
(11.6 - 38.1 m)

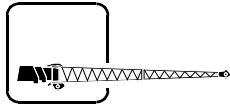

32 - 52 ft.  
(9.8 - 16.0 m)

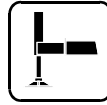

360°

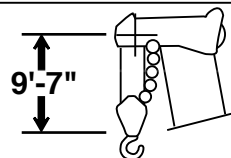
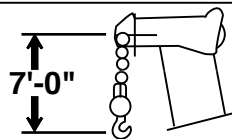
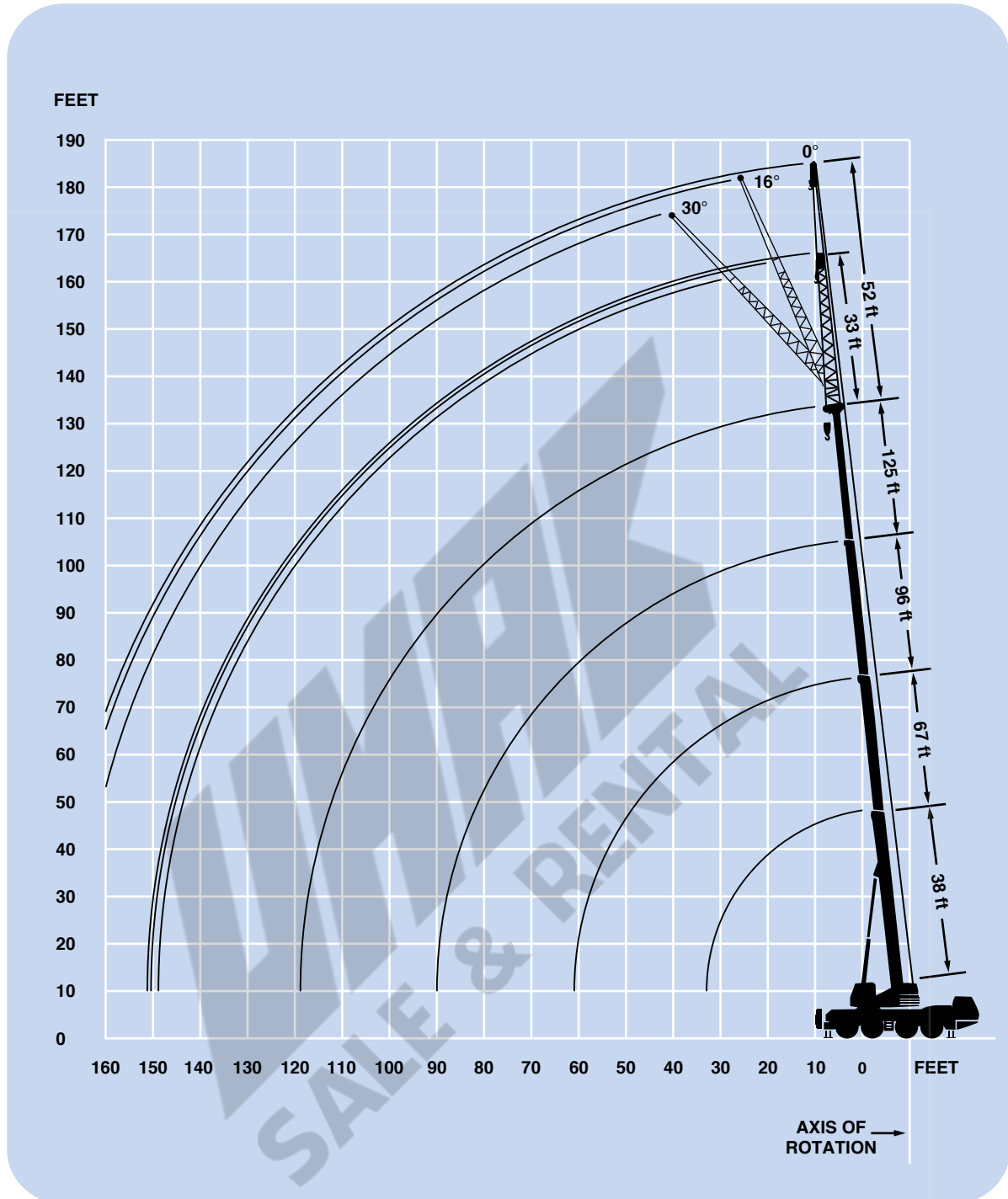

**DIMENSIONS ARE FOR LARGEST GROVE FURNISHED HOOK BLOCK AND HEADACHE BALL, WITH ANTI-TWO BLOCK ACTIVATED.**





38 - 125 ft.  
(11.6 - 38.1 m)



29,500 lbs.  
(13 400 kg)



27.4 x 23.6 ft.



360°



(Feet)



Pounds

	38	67	67	96	96	113	125
10	162,000						
15	126,000	85,000	43,600				
20	100,000	79,000	43,600	43,600	24,200	34,000	
25	77,000	68,000	43,600	43,600	24,200	32,400	24,200
30		55,000	43,000	38,800	24,200	29,400	24,200
35		42,200	38,400	34,800	24,200	26,800	24,200
40		33,600	34,600	31,400	24,200	24,600	24,000
45		27,600	29,400	27,200	22,400	22,600	22,200
50		23,000	24,800	22,600	20,600	20,800	20,400
55				18,800	19,200	19,000	18,600
60				15,800	17,800	17,200	17,000
65				13,200	16,600	14,600	15,400
70				11,200	15,400	12,400	13,200
75				9,400	13,600	10,600	11,400
80				7,800	12,000	9,200	9,800
85				6,600	10,600	7,800	8,600
90						6,600	7,400
95						5,600	6,400
100							5,400
105							4,600
110							4,000

All main boom charts available with 50% Outriggers.



	T1	T2	T3	T1	T2	T3	T1	T2	T3
T1	0	50	0	100	0	100	100	100	100
T2	0	50	100	100	100	100	100	100	100
T3	0	0	0	0	100	60	100	100	100



38 - 125 ft.  
(11.6 - 38.1 m)



16,800 lbs.  
(7600 kg)



27.4 x 23.6 ft.



360°



(Feet)



Pounds

	38	67	67	96	96	113	125
10	162,000						
15	125,000	85,000	43,600				
20	96,000	79,000	43,600	43,600	24,200	34,000	
25	64,000	59,000	43,600	43,600	24,200	32,400	24,200
30		45,000	43,000	38,800	24,200	29,400	24,200
35		34,400	36,400	31,600	24,200	26,800	24,200
40		27,000	29,000	25,200	24,200	24,600	24,000
45		21,400	23,400	20,600	22,400	21,200	21,600
50		17,200	19,200	16,800	20,600	17,800	18,200
55				13,600	18,200	14,800	15,400
60				11,000	15,400	12,400	13,000
65				8,800	13,200	10,200	11,000
70				7,200	11,400	8,400	9,200
75				5,600	9,800	7,000	7,800
80				4,400	8,600	5,800	6,400
85				3,400	7,400	4,600	5,400
90						3,600	4,400
95						2,800	3,600
100							2,800
105							2,200
110							1,600



	T1	T2	T3	T1	T2	T3	T1	T2	T3
T1	0	50	0	100	0	100	100	100	100
T2	0	50	100	100	100	100	100	100	100
T3	0	0	0	0	100	60	100	100	100





38 - 125 ft.  
(11.6 - 38.1 m)



4,000 lbs.  
(1800 kg)



27.4 x 23.6 ft.



360°



(Feet)



Pounds

	38	67	67	96	96	113	125
10	161,000						
15	122,000	85,000	43,600				
20	80,000	64,000	43,600	43,600	24,200	34,000	
25	51,000	46,000	43,600	38,800	24,200	32,400	24,200
30		33,000	36,000	28,400	24,200	28,400	24,200
35		25,200	27,600	21,800	24,200	22,200	22,400
40		18,800	21,200	16,800	22,800	17,600	18,000
45		14,400	16,600	13,200	18,800	14,000	14,600
50		11,000	13,200	10,400	15,400	11,400	11,800
55				8,200	12,800	9,200	9,600
60				6,200	10,600	7,400	7,800
65				4,400	8,800	5,800	6,400
70				3,200	7,400	4,400	5,200
75				2,000	6,200	3,200	4,000
80				1,400	5,200	2,200	3,000
85					4,200	1,400	2,200
90							1,400

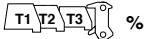

T1 T2 T3 %	0	50	0	100	0	100	100
T1	0	50	0	100	0	100	100
T2	0	50	100	100	100	100	100
T3	0	0	0	0	100	60	100



38 - 125 ft.  
(11.6 - 38.1 m)



0 lbs.  
(0 kg)



27.4 x 23.6 ft.



360°



(Feet)



Pounds

	38	67	67	96	96	113	125
10	161,000						
15	120,000	85,000	43,600				
20	74,000	59,000	43,600	43,600	24,200	34,000	
25	47,000	40,600	43,600	34,200	24,200	32,400	24,200
30		29,000	32,000	24,800	24,200	25,000	24,200
35		21,800	24,600	18,800	24,200	19,200	19,600
40		16,200	18,600	14,200	20,000	15,000	15,400
45		12,200	14,400	11,000	16,600	11,800	12,400
50		9,200	11,200	8,400	13,600	9,400	10,000
55				6,200	11,000	7,400	8,000
60				4,600	9,200	5,600	6,200
65				3,200	7,400	4,200	5,000
70				1,800	6,200	3,000	3,800
75					5,000	2,000	2,800
80					4,200		1,800
85					3,200		



T1 T2 T3 %	0	50	0	100	0	100	100
T1	0	50	0	100	0	100	100
T2	0	50	100	100	100	100	100
T3	0	0	0	0	100	60	100





110.5 - 125 ft.  
(33.7 - 38.1 m)

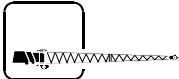

32.8 - 52 ft  
(10 - 16.0 m)



29,500 lbs.  
(13 400 kg)



27.4 x 23.6 ft.



360°

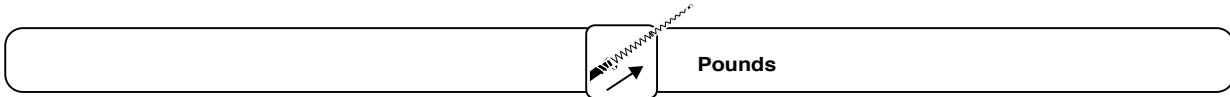

(Feet)	110.5' Main Boom			125' Main Boom		
	0° - 32.8'	16° - 32.8'	30° - 32.8'	0° - 32.8'	16° - 32.8'	30° - 32.8'
30	17,400	12,200		11,200		
35	16,400	12,200	8,800	11,200	8,800	6,600
40	15,400	12,000	8,800	11,200	8,800	6,600
45	14,400	11,400	8,800	11,200	8,800	6,600
50	13,600	11,000	8,800	11,000	8,400	6,400
55	12,600	10,400	8,600	10,200	8,000	6,000
60	11,800	10,200	8,200	9,600	7,600	5,800
65	11,000	9,800	7,800	9,000	7,400	5,600
70	10,200	9,400	7,400	8,400	7,000	5,400
75	9,600	8,800	7,200	7,800	6,600	5,200
80	9,000	8,400	6,800	7,400	6,400	5,200
85	8,400	7,800	6,600	7,000	6,000	5,000
90	7,800	7,200	6,400	6,600	5,800	5,000
95	6,600	6,600	6,200	6,200	5,600	4,800
100	5,800	6,000	6,000	6,000	5,400	4,800
105	5,000	5,200	5,400	5,200	5,000	4,600
110	4,200	4,400	4,600	4,600	4,800	4,600
115	3,400	3,800	3,800	3,800	4,200	4,400
120	2,800	3,000	3,200	3,200	3,600	3,800
125	2,400	2,400	2,400	2,600	3,000	3,000
130	1,800	1,800	1,800	2,200	2,400	2,400
135				1,800	1,800	2,000
140						
145						
150						

T1 T2 T3 %

T1	100	100	100	100	100	100
T2	100	100	100	100	100	100
T3	50	50	50	100	100	100

SALE & RENTAL





110.5 - 125 ft.  
(33.7 - 38.1 m)

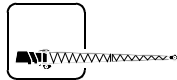

32.8 - 52 ft  
(10 - 16.0 m)



29,500 lbs.  
(13 400 kg)



27.4 x 23.6 ft.



360°

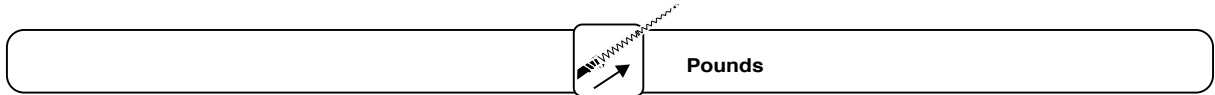

(Feet)	110.5' Main Boom			125' Main Boom		
	0° - 52'	16° - 52"	30° - 52"	0° - 52"	16° - 52"	30° - 52"
30	8,400					
35	8,400	8,400		6,000		
40	8,400	8,400		6,000	6,000	
45	8,400	8,400	5,000	6,000	6,000	
50	8,000	7,800	5,000	6,000	6,000	4,400
55	7,800	7,400	5,000	6,000	5,800	4,400
60	7,400	7,000	4,800	6,000	5,600	4,400
65	7,200	6,600	4,600	5,800	5,400	4,200
70	6,800	6,200	4,400	5,600	5,200	4,000
75	6,600	5,800	4,200	5,200	5,000	4,000
80	6,400	5,400	4,000	4,800	4,800	3,800
85	6,200	5,200	3,800	4,600	4,600	3,800
90	6,000	5,000	3,600	4,400	4,400	3,600
95	5,800	4,800	3,600	4,200	4,000	3,600
100	5,800	4,800	3,400	4,000	3,800	3,600
105	5,600	4,800	3,200	4,000	3,600	3,400
110	5,000	4,600	3,000	3,800	3,400	3,400
115	4,200	4,600	2,800	3,800	3,200	3,400
120	3,600	4,200	2,800	3,600	3,200	3,200
125	3,000	3,600	2,600	3,400	3,000	3,200
130	2,600	3,000	2,400	2,800	3,000	3,200
135	2,000	2,400	2,400	2,400	2,800	3,000
140	1,600	2,000	2,000	1,800	2,200	2,400
145					1,800	2,000
150					1,400	1,400
T1 T2 T3 %						
T1	100	100	100	100	100	100
T2	100	100	100	100	100	100
T3	50	50	50	100	100	100

SALE & RENTAL







110.5 - 125 ft.  
(33.7 - 38.1 m)

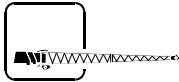

32.8 - 52 ft  
(10 - 16.0 m)



16,800 lbs.  
(7600 kg)



27.4 x 23.6 ft.



360°



(Feet)	110.5' Main Boom			125' Main Boom		
	0° - 32.8'	16° - 32.8'	30° - 32.8'	0° - 32.8'	16° - 32.8'	30° - 32.8'
30	17,400	12,200		11,200		
35	16,400	12,200	8,800	11,200	8,800	6,600
40	15,400	12,000	8,800	11,200	8,800	6,600
45	14,400	11,400	8,800	11,200	8,800	6,600
50	13,600	11,000	8,800	11,000	8,400	6,400
55	12,600	10,400	8,600	10,200	8,000	6,000
60	11,800	10,200	8,200	9,600	7,600	5,800
65	11,000	9,800	7,800	9,000	7,400	5,600
70	9,600	9,400	7,400	8,400	7,000	5,400
75	8,200	8,800	7,200	7,800	6,600	5,200
80	6,800	7,600	6,800	7,200	6,400	5,200
85	5,800	6,400	6,600	6,200	6,000	5,000
90	4,800	5,200	5,600	5,200	5,800	5,000
95	3,800	4,400	4,600	4,200	4,800	4,800
100	3,000	3,600	3,800	3,400	4,000	4,200
105	2,400	2,800	3,000	2,800	3,200	3,400
110	1,800	2,200	2,200	2,200	2,600	2,800
115		1,400	1,600	1,600	2,000	2,200
120					1,400	1,600
125						
130						
135						
140						
T1	100	100	100	100	100	100
T2	100	100	100	100	100	100
T3	50	50	50	100	100	100

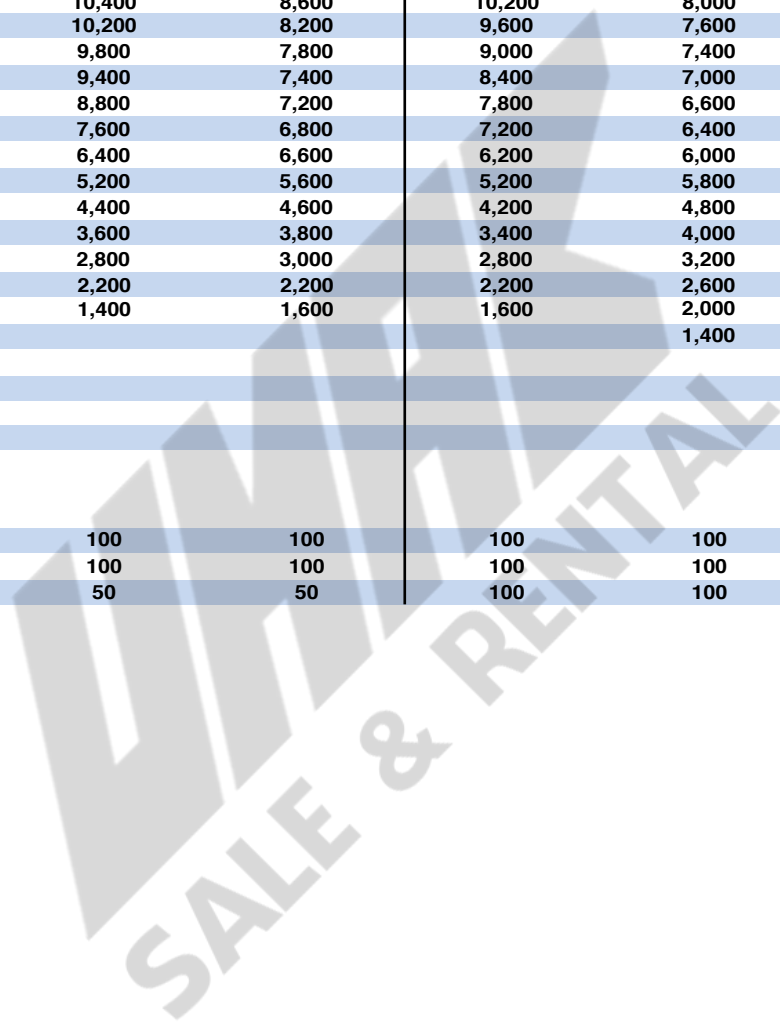



110.5 - 125 ft.  
(33.7 - 38.1 m)

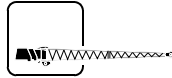

32.8 - 52 ft  
(10 - 16.0 m)



16,800 lbs.  
(7600 kg)



27.4 x 23.6 ft.



360°

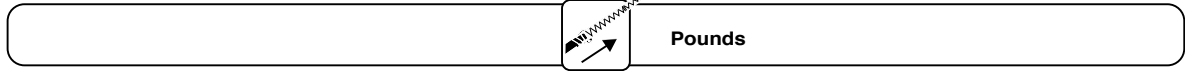

(Feet)	110.5' Main Boom			125' Main Boom		
	0° - 52'	16° - 52'	30° - 52'	0° - 52'	16° - 52'	30° - 52'
30	8,400					
35	8,400	8,400		6,000		
40	8,400	8,400		6,000	6,000	
45	8,400	8,400	5,000	6,000	6,000	
50	8,000	7,800	5,000	6,000	6,000	4,400
55	7,800	7,400	5,000	6,000	5,800	4,400
60	7,400	7,000	4,800	6,000	5,600	4,400
65	7,200	6,600	4,600	5,800	5,400	4,200
70	6,800	6,200	4,400	5,600	5,200	4,000
75	6,600	5,800	4,200	5,200	5,000	4,000
80	6,400	5,400	4,000	4,800	4,800	3,800
85	6,200	5,200	3,800	4,600	4,600	3,800
90	5,600	5,000	3,600	4,400	4,400	3,600
95	4,800	4,800	3,600	4,200	4,000	3,600
100	4,000	4,800	3,400	4,000	3,800	3,600
105	3,200	4,000	3,200	3,400	3,600	3,400
110	2,600	3,200	3,000	2,800	3,400	3,400
115	2,000	2,600	2,800	2,200	3,000	3,400
120	1,600	2,000	2,400	1,800	2,400	2,800
125		1,600	1,800	1,200	1,800	2,200
130			1,200		1,400	1,600
135						
140						



	%					
T1	100	100	100	100	100	100
T2	100	100	100	100	100	100
T3	50	50	50	100	100	100

SALE & RENTAL

