

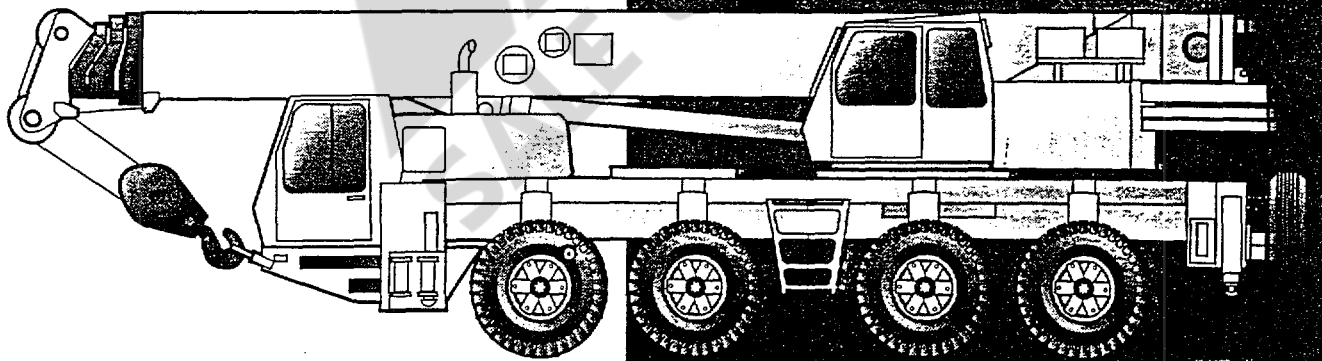

GROVE[®]
CRANE

A GROVE WORLDWIDE COMPANY

GMK 4085



All Terrain Hydraulic Crane

Dimensions

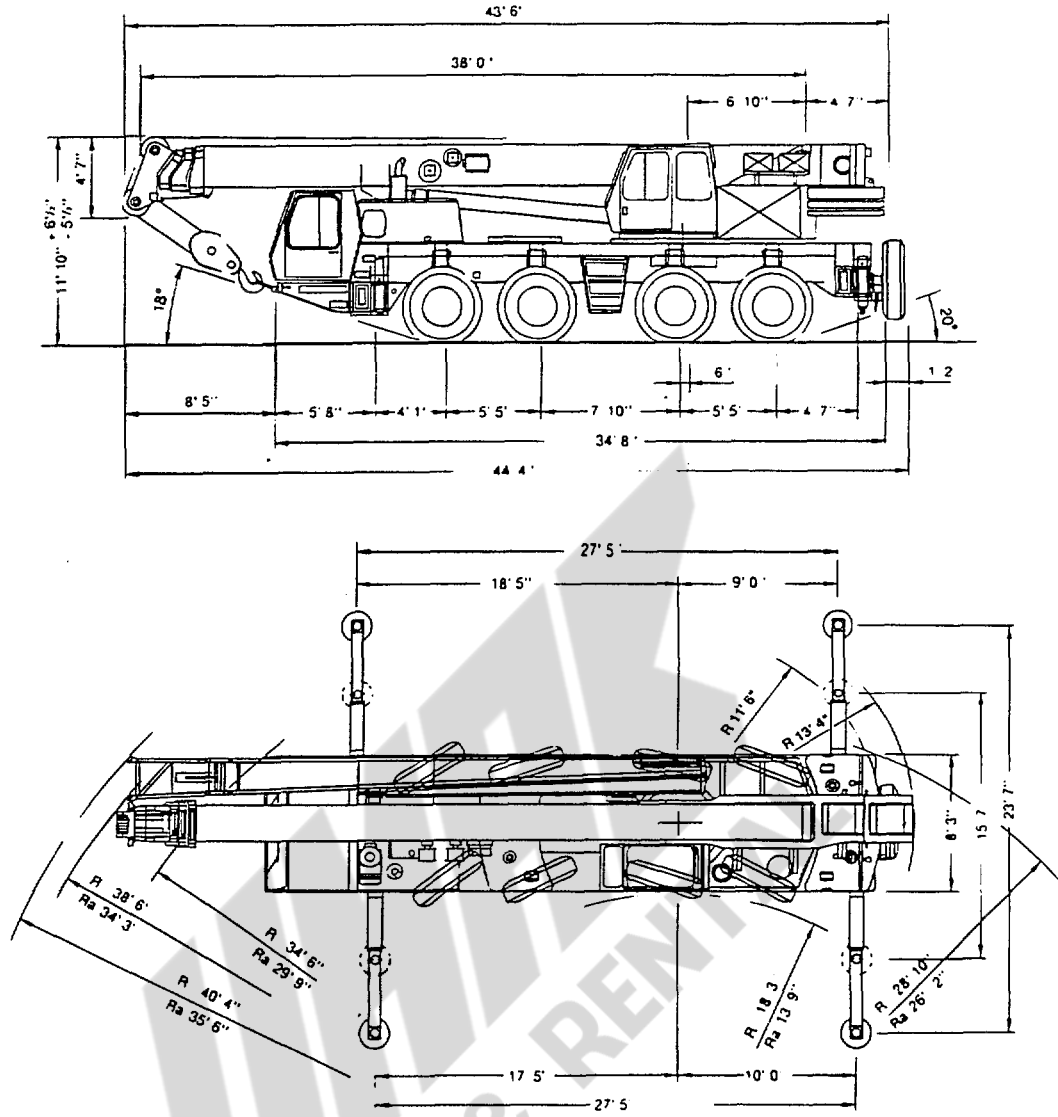

Ra, ra = Radius all wheels steered

Model GMK 4085 equipped with:	Front (2)	Rear (2)	Total
8X6X8 drive/steer, 20.5R25 tires; 7,500 lbs. fixed counterweight	51,085 lbs. (2 X 25,543)	42,185 lbs. (2 X 21,093)	93,270 lbs.

Weights for accessory equipment:

1. Oil cooler (superstructure)	- 37	+ 213	+ 176
2. Lattice extension w/brackets (33 - 53 ft.) stowed on boom	+ 4,310	- 1,410	+ 2,900
3. Auxiliary hoist with cable	- 1,915	+ 4,528	+ 2,613
4. 16.00R25 tires in lieu of 20.5R25 tires	- 535	- 535	- 1,070
5. 14.00R25 tires in lieu of 20.5R25 tires	- 1,235	- 1,235	- 2,470
6. Spare tire (on rear of carrier w/carry bracket)			
14.00R25	- 415	+ 1,015	+ 600
16.00R25	- 625	+ 1,495	+ 870
20.5R25	- 637	+ 1,530	+ 893
7. Outrigger floats stowed	+ 64	+ 68	+ 132
8. 8X8X8 drive/steer	+ 215	+ 820	+ 1,035

Working range



38 - 125 ft.
(11.6 - 38.1 m)

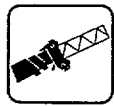

33 - 52 ft.
(10.1 - 15.8 m)

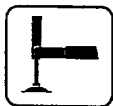

360°

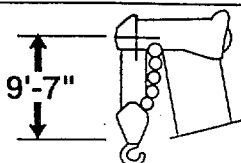
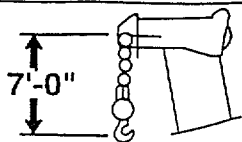
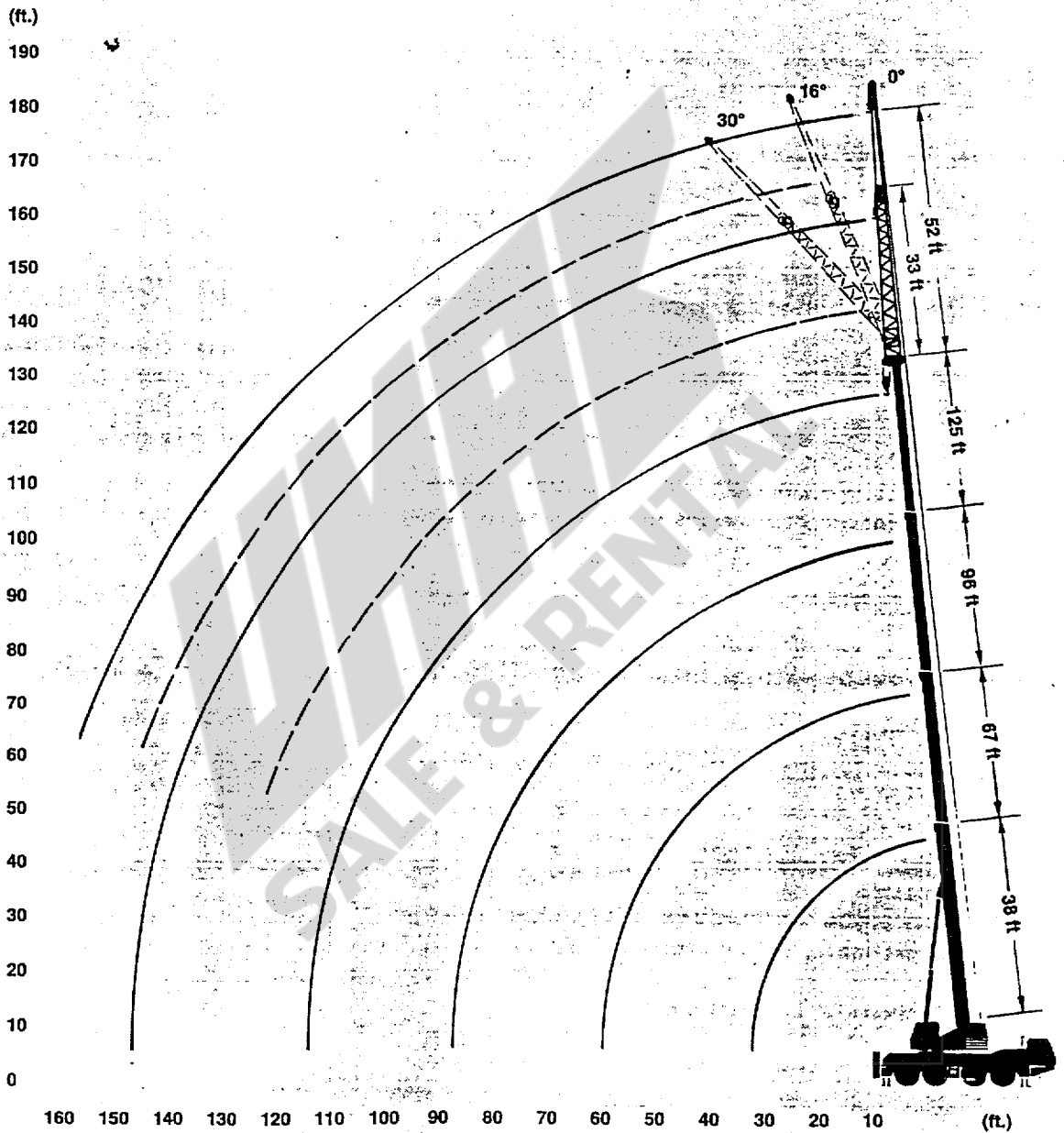

DIMENSIONS ARE FOR LARGEST GROVE FURNISHED HOOK BLOCK AND HEADACHE BALL, WITH ANTI-TWO BLOCK ACTIVATED.

Superstructure specifications

Boom

38 ft. to 125 ft. (11.6 m to 38.1 m) four-section full power boom. Maximum tip height: 135 ft. (41 m).

Lattice Extension

Two-stage, 33 ft. to 52 ft. (10.0 m to 15.8 m) lattice extension offsettable at 16° and 30°. Stows alongside base boom section. Maximum tip height: 187 ft. (57 m).

Boom Elevation

Single cylinder with integral holding valve provides elevation from -1.5° to 84°.

Load Moment & Anti-Two Block System

Load moment and anti-two block system with audio-visual warning and control lever lock-out. These systems provide electronic display of boom angle, length, radius, tip height, relative load moment, maximum permissible load, load indication and warning of impending two-block condition.

Cab

Full vision *aluminum* cab, safety glass windows, adjustable operator's seat with hydraulic suspension, engine-independent heating, instrumentation and operating controls for carrier and superstructure.

Swing

Axial piston motor with planetary gear. Holding and service brake. Swing speed variable from 0 - 25 RPM.

Counterweight

29,500 lbs. (13 381 kg) total. Hydraulically installed and removed.

Hydraulic System

Three separate pump circuits: two axial piston pumps with integrated infinitely variable speed and load control and one fixed displacement pump for swing.

210 gallon (796 L) reservoir capacity.

All crane movements infinitely variable by hydraulic pilot circuit control levers with automatic reset to zero.

HOIST SPECIFICATIONS

Main Hoist

Axial piston variable displacement motor with integrated planetary gear and multiple disk brake. Rope drum with special grooving.

Single line pull:	13,700 lbs. (6214 kg)
Single line speed:	410 FPM (125 m/min)
Rope diameter:	3/4 in. (19 mm)
Rope length:	590 ft. (180 m)

Auxiliary Hoist

Axial piston variable displacement motor with integrated planetary gear and multiple disk brake. Rope drum with special grooving.

Single line pull:	13,700 lbs. (6214 kg)
Single line speed:	410 FPM (125 m/min)
Rope diameter:	3/4 in. (19 mm)
Rope length:	526 ft. (160 m)

Carrier specifications

Chassis

Four-axle, all-welded torsion-resistant box-type construction of high strength steel.

Outriggers

Four hydraulically telescoping beam outriggers with vertical cylinders and outrigger pads. Independent horizontal and vertical movement control on each side of chassis. Crane level indicators at each control station.

Engine

Daimler Benz OM 442 diesel, 8 cylinders, water-cooled with turbocharger, 367 hp (270 kW) @ 2100 RPM. Maximum torque: 1600 Nm at 1100 to 1500 RPM.

Fuel Tank Capacity

100 gallons (378 L).

Transmission

Automatic powershift transmission with 5 forward and 1 reverse gears. Two speed transfer case with longitudinal differential lock.

Drive

8 x 6 x 8

Axles

1st axle line - drive/steer.
2nd axle line - drive/steer.
3rd axle line - steer (off road only).
4th axle line - drive/steer.

Drive axles with planetary hub reduction and center mounted gearing.

Suspension

Exclusive "MEGA TRACK" independent hydropneumatic suspension and hydraulic axle lock-out. Dual level control. Suspension range: +6.5 in. (165 mm) to -5.5 in. (-139 mm). Possible combinations for transverse slope.

Tires

8 - 20.5R25 radials.

Steering

Dual-circuit. Automatic switch-in of standby steering pump in case of main pump failure.

Brakes

Service brake: pneumatic dual circuit acting on all wheels. Air dryer.

Auxiliary brake: hydraulic retarder integrated with automatic transmission.

Parking brake: pneumatically operated spring-loaded brake acting on 2nd and 4th axle line.

Cab

Aluminum, two-man design, safety glass, driver's seat with hydraulic suspension, engine hot water heater. Complete instrumentation and driving controls. Cab can be tilted forward by 60° for easy access to engine, transmission, hydraulic pumps, heater and batteries.

Electrical System

24 V lighting system and signals.
Generator: 28 V / 55 A.
Two batteries: 12 V / 143 Ah each.

Maximum Speed

47 mph (75 kph)

Maximum Gradeability

75% (theoretical)

Miscellaneous Standard Equipment

Hydraulic oil cooler; spare tire and wheel - 20.5R25 with carry bracket; spare parts/service manuals; hoist drum rotation indicators; flashing amber warning light on carrier cab; working light; tool kit; wheel chocks; fire extinguisher; rooster sheave; radio/cassette in carrier cab.

Optional Equipment

- * 8 x 8 drive
- * Hook blocks and headache balls

**Denotes optional equipment.*



38 - 125 ft.
(11.6 - 38.1 m)



29,500 lbs.
(13 381 kg)



360°

T1 T2 T3 T4 %

T1	0.00	0.50	0.00	1.00	0.00	1.00	1.00
T2	0.00	0.50	1.00	1.00	1.00	1.00	1.00
T3	0.00	0.00	0.00	0.00	1.00	0.60	1.00
T4	0.00	0.00	0.00	0.00	0.00	0.00	0.00



(Feet)



85% Domestic (Pounds)

	38	67	67	96	96	113	125
10	170,000						
15	133,000	85,000	43,600				
20	100,000	79,000	43,600	43,600	24,200	34,000	
25	79,000	68,000	43,600	43,600	24,200	32,400	24,200
30		57,000	43,000	38,800	24,200	29,400	24,200
35		44,000	38,400	34,800	24,200	26,800	24,200
40		35,200	34,600	31,400	24,200	24,600	24,000
45		28,800	30,600	28,600	22,400	22,600	22,200
50		24,000	25,800	23,800	20,600	20,800	20,400
55				19,600	19,200	19,000	18,600
60				16,400	17,800	17,200	17,000
65				13,800	16,600	15,200	15,600
70				11,600	15,600	13,000	13,800
75				9,800	14,000	11,200	11,800
80				8,200	12,400	9,600	10,200
85				6,800	11,000	8,200	8,800
90						7,000	7,600
95						6,000	6,600
100							5,600
105							4,800
110							4,000

2297860.1

THIS CHART IS ONLY A GUIDE AND SHOULD NOT BE USED TO OPERATE THE CRANE. The individual crane's load chart, operating instructions and other instructional plates must be read and understood prior to operating the crane.



38 - 125 ft.
(11.6 - 38.1 m)



16,800 lbs.
(7 600 kg)



360°

T1 T2 T3 T4 %

T1	0.00	0.50	0.00	1.00	0.00	1.00	1.00
T2	0.00	0.50	1.00	1.00	1.00	1.00	1.00
T3	0.00	0.00	0.00	0.00	1.00	0.60	1.00
T4	0.00	0.00	0.00	0.00	0.00	0.00	0.00



85% Domestic (Pounds)

(Feet)	38	67	67	96	96	113	125
10	170,000						
15	133,000	85,000	43,600				
20	95,000	79,000	43,600	43,600	24,200	34,000	
25	67,000	65,000	43,600	43,600	24,200	32,400	24,200
30		46,000	43,000	38,800	24,200	29,400	24,200
35		35,200	37,200	34,800	24,200	26,800	24,200
40		27,200	29,200	27,000	24,200	24,600	24,000
45		21,400	23,400	21,200	22,400	22,600	22,200
50		17,200	19,200	16,800	20,600	18,400	19,400
55				13,600	18,200	15,000	16,000
60				11,000	15,400	12,400	13,200
65				8,800	13,200	10,200	11,000
70				7,000	11,400	8,400	9,200
75				5,600	9,800	7,000	7,600
80				4,200	8,400	5,600	6,400
85				3,200	7,200	4,600	5,200
90						3,600	4,200
95						2,800	3,400
100							2,600
105							2,000
110							1,400

2297880.1



38 - 125 ft.
(11.6 - 38.1 m)



7,500 lbs.
(3 400 kg)



360°

T1 T2 T3 T4 %

T1	0.00	0.50	0.00	1.00	0.00	1.00	1.00
T2	0.00	0.50	1.00	1.00	1.00	1.00	1.00
T3	0.00	0.00	0.00	0.00	1.00	0.60	1.00
T4	0.00	0.00	0.00	0.00	0.00	0.00	0.00



(Feet)



85% Domestic (Pounds)

(Feet)	38	67	67	96	96	113	125
10	170,000						
15	122,000	85,000	43,600				
20	90,000	79,000	43,600	43,600	24,200	34,000	
25	58,000	57,000	43,600	43,600	24,200	32,400	24,200
30		40,400	42,800	37,200	24,200	29,400	24,200
35		29,600	31,800	28,400	24,200	26,800	24,200
40		22,400	24,600	22,200	24,200	23,200	23,600
45		17,400	19,400	17,000	22,000	18,800	19,200
50		13,500	15,500	13,200	18,000	14,800	15,800
55				10,400	15,000	12,000	12,800
60				8,000	12,600	9,600	10,400
65				6,200	10,600	7,600	8,400
70				4,600	9,000	6,200	6,800
75				3,400	7,600	4,800	5,600
80				2,200	6,400	3,600	4,400
85				1,200	5,400	2,600	3,400
90						1,800	2,600
95							1800

2297790

SALE & RENTAL



111 ft.
(33.8 m)



33 - 52 ft.
(10.1-15.8 m)



29,500 lbs.
(13 381 kg)



360°



85% Domestic (Pounds)

(Feet)	33 - 0°	33 - 16°	33 - 30°	52 - 0°	52 - 16°	52 - 30°
30	17,400	12,200		8,400		
35	16,400	12,200	8,800	8,400	8,400	
40	15,400	12,000	8,800	8,400	8,400	
45	14,400	11,400	8,800	8,400	8,400	5,000
50	13,600	11,000	8,800	8,000	7,800	5,000
55	12,600	10,400	8,600	7,800	7,400	5,000
60	11,800	10,200	8,200	7,400	7,000	4,800
65	11,000	9,800	7,800	7,200	6,600	4,600
70	10,200	9,400	7,400	6,800	6,200	4,400
75	9,600	8,800	7,200	6,600	5,800	4,200
80	9,000	8,400	6,800	6,400	5,400	4,000
85	8,400	7,800	6,600	6,200	5,200	3,800
90	7,800	7,200	6,400	6,000	5,000	3,600
95	7,000	6,600	6,200	5,800	4,800	3,600
100	6,000	6,000	6,000	5,800	4,800	3,400
105	5,200	5,400	5,800	5,600	4,800	3,200
110	4,400	4,800	4,800	5,200	4,600	3,000
115	3,600	4,000	4,000	4,400	4,600	2,800
120	3,000	3,200	3,400	3,800	4,400	2,800
125	2,400	2,600	2,600	3,200	3,800	2,600
130	2,000	2,000	2,000	2,600	3,200	2,400
135				2,200	2,600	2,400
140				1,800	2,000	2,200



111 ft.
(33.8 m)



33 - 52 ft.
(10.1-15.8 m)



16,800 lbs.
(7,620 kg)



360°



85% Domestic (Pounds)

(Feet)	33 - 0°	33 - 16°	33 - 30°	52 - 0°	52 - 16°	52 - 30°
30	17,400	12,200		8,400		
35	16,400	12,200	8,800	8,400	8,400	
40	15,400	12,000	8,800	8,400	8,400	
45	14,400	11,400	8,800	8,400	8,400	5,000
50	13,600	11,000	8,800	8,000	7,800	5,000
55	12,600	10,400	8,600	7,800	7,400	5,000
60	11,800	10,200	8,200	7,400	7,000	4,800
65	11,000	9,800	7,800	7,200	6,600	4,600
70	9,800	9,400	7,400	6,800	6,200	4,400
75	8,200	8,800	7,200	6,600	5,800	4,200
80	7,000	7,600	6,800	6,400	5,400	4,000
85	5,800	6,400	6,600	6,200	5,200	3,800
90	4,800	5,200	5,600	5,600	5,000	3,600
95	3,800	4,400	4,600	4,600	4,800	3,600
100	3,000	3,400	3,800	3,800	4,600	3,400
105	2,400	2,600	3,000	3,000	3,800	3,200
110	1,600	2,000	2,200	2,400	3,200	3,000
115	1,200	1,400	1,600	1,800	2,400	2,800
120				1,400	2,000	2,200
125					1,400	1,600



111 ft.
(33.8 m)

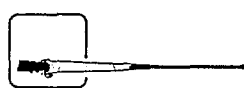

33 - 52 ft.
(10.1-15.8m)



7,500 lbs.
(3 400 kg)



360°



85% Domestic (Pounds)

(Feet)	33 - 0°	33 - 16°	33 - 30°	52 - 0°	52 - 16°	52 - 30°
30	17,400	12,200		8,400		
35	16,400	12,200	8,800	8,400	8,400	
40	15,400	12,000	8,800	8,400	8,400	
45	14,400	11,400	8,800	8,400	8,400	5,000
50	13,600	11,000	8,800	8,000	7,800	5,000
55	12,600	10,400	8,600	7,800	7,400	5,000
60	11,200	10,200	8,200	7,400	7,000	4,800
65	9,200	9,800	7,800	7,200	6,600	4,600
70	7,400	8,400	7,400	6,800	6,200	4,400
75	6,000	6,800	7,200	6,600	5,800	4,200
80	4,800	5,600	6,000	5,800	5,400	4,000
85	3,800	4,400	5,000	4,600	5,200	3,800
90	3,000	3,600	3,800	3,800	4,800	3,600
95	2,200	2,600	3,000	3,000	3,800	3,600
100	1,400	2,000	2,200	2,200	3,200	3,400
105		1,200	1,400	1,600	2,400	3,000
110					1,800	2,200
115					1,200	1,600



125 ft.
(38.1 m)



33 - 52 ft.
(10.1-15.8 m)



29,500 lbs.
(13 400 kg)



360°



85% Domestic (Pounds)

(Feet)	33 - 0°	33 - 16°	33 - 30°	52 - 0°	52 - 16°	52 - 30°
30	11,200					
35	11,200	8,800	6,600	6,000		
40	11,200	8,800	6,600	6,000	6,000	
45	11,200	8,800	6,600	6,000	6,000	
50	11,000	8,400	6,400	6,000	6,000	4,400
55	10,200	8,000	6,000	6,000	5,800	4,400
60	9,600	7,600	5,800	6,000	5,600	4,400
65	9,000	7,400	5,600	5,800	5,400	4,200
70	8,400	7,000	5,400	5,600	5,200	4,000
75	7,800	6,600	5,200	5,200	5,000	4,000
80	7,400	6,400	5,200	4,800	4,800	3,800
85	7,000	6,000	5,000	4,600	4,600	3,800
90	6,600	5,800	5,000	4,400	4,400	3,600
95	6,200	5,600	4,800	4,200	4,000	3,600
100	6,000	5,400	4,800	4,000	3,800	3,600
105	5,600	5,000	4,600	4,000	3,600	3,400
110	4,800	4,800	4,600	3,800	3,400	3,400
115	4,200	4,400	4,600	3,800	3,200	3,400
120	3,400	3,800	4,000	3,600	3,200	3,200
125	2,800	3,200	3,200	3,400	3,000	3,200
130	2,400	2,600	2,600	3,000	3,000	3,200
135	1,800	2,000	2,000	2,400	2,800	3,000
140	1,400	1,600	1,400	2,000	2,400	2,600
145				1,600	1,800	2,000
150				1,200	1,400	1,600



125 ft.
(38.1 m)



33 - 52 ft.
(10.1-15.8 m)



16,800 lbs.
(7 600 kg)



360°



85% Domestic (Pounds)

(Feet)	33 - 0°	33 - 16°	33 - 30°	52 - 0°	52 - 16°	52 - 30°
30	11,200					
35	11,200	8,800	6,600	6,000		
40	11,200	8,800	6,600	6,000	6,000	
45	11,200	8,800	6,600	6,000	6,000	
50	11,000	8,400	6,400	6,000	6,000	4,400
55	10,200	8,000	6,000	6,000	5,800	4,400
60	9,600	7,600	5,800	6,000	5,600	4,400
65	9,000	7,400	5,600	5,800	5,400	4,200
70	8,400	7,000	5,400	5,600	5,200	4,000
75	7,800	6,600	5,200	5,200	5,000	4,000
80	7,400	6,400	5,200	4,800	4,800	3,800
85	6,200	6,000	5,000	4,600	4,600	3,800
90	5,200	5,800	5,000	4,400	4,400	3,600
95	4,200	4,800	4,800	4,200	4,000	3,600
100	3,400	4,000	4,200	4,000	3,800	3,600
105	2,800	3,200	3,400	3,400	3,600	3,400
110	2,200	2,400	2,800	2,800	3,400	3,400
115	1,600	1,800	2,000	2,200	2,800	3,200
120		1,400	1,400	1,600	2,200	2,600
125				1,200	1,600	2,000
130					1,200	1,400



125 ft.
(38.1 m)



33 - 52 ft.
(10.1-15.8 m)



7,500 lbs.
(3 400 kg)



360°



85% Domestic (Pounds)

(Feet)	33 - 0°	33 - 16°	33 - 30°	52 - 0°	52 - 16°	52 - 30°
30	11,200					
35	11,200	8,800	6,600	6,000		
40	11,200	8,800	6,600	6,000	6,000	
45	11,200	8,800	6,600	6,000	6,000	
50	11,000	8,400	6,400	6,000	6,000	4,400
55	10,200	8,000	6,000	6,000	5,800	4,400
60	9,600	7,600	5,800	6,000	5,600	4,400
65	9,000	7,400	5,600	5,800	5,400	4,200
70	8,000	7,000	5,400	5,600	5,200	4,000
75	6,600	6,600	5,200	5,200	5,000	4,000
80	5,400	6,000	5,200	4,800	4,800	3,800
85	4,400	5,000	5,000	4,600	4,600	3,800
90	3,400	4,000	4,400	4,000	4,400	3,600
95	2,600	3,200	3,400	3,200	4,000	3,600
100	2,000	2,400	2,600	2,600	3,400	3,600
105	1,200	1,800	2,000	1,800	2,600	3,200
110			1,400	1,400	2,000	2,600
115					1,400	2,000
120						1,400

THIS CHART IS ONLY A GUIDE AND SHOULD NOT BE USED TO OPERATE THE CRANE. The individual crane's load chart, operating instructions and other instructional plates must be read and understood prior to operating the crane.



38 - 67 ft.
(11.6 - 20.4 m)



29,500 lbs.
(13 400 kg)



0°



(Feet)	38	67
10	38,300	
15	28,300	29,100
20	21,400	22,200
25	16,600	17,500
30		13,900
35		11,200
40		8,900
45		7,100
50		5,600

On rubber capacities directly over rear of machine.
CAUTION: Outriggers must be set prior to slewing the boom.

WMA
SALE & RENTAL

Rated lifting capacities

IMPORTANT NOTES:

WARNING: THIS CHART IS ONLY A GUIDE.

The notes below are for illustration only and should not be relied upon to operate the crane. The individual crane's load chart, operating instructions and other instruction plates must be read and understood prior to operating the crane.

1. All rated loads have been tested to and meet minimum requirements of SAEJ1063 OCT80 - Cantilevered Boom Crane Structures - Method of Test, and do not exceed 85% of the tipping load on outriggers as determined by SAEJ765 OCT80 Crane Stability Test Code.

2. Capacities given do not include the weight of hook blocks, slings, auxiliary lifting equipment and load handling devices. Their weights must be added to the load to be lifted. When more than minimum required reeving is used, the additional rope weight shall be considered part of the load.



































3. Capacities appearing above the bold line are based on structural strength and tipping should not be relied upon as a capacity limitation.

4. All capacities are for crane on firm, level surface. It may be necessary to have structural supports under the outrigger floats or tires to spread the load to a larger bearing surface.

5. When either boom length or radius or both are between values listed, the smallest load shown at either the next larger radius or boom length shall be used.

6. For outrigger operation, ALL outriggers shall be properly extended with tires raised free of ground before raising the boom or lifting loads.

Symbols Glossary

	Frame		Steering
	Outriggers		Transmission
	Outrigger Controls		Axles
	Engine		Brakes
	Fuel Tank Capacity		Tires
	Electrical System		Suspension
	Drive		360° Rotation
	Lights		Boom Elevation
	Cab		Swing
	Boom		Counterweight
	Fixed Swingaway		Oil
	Tele-Swingaway		Hydraulic System
	Jib		Hoist
	Boom Nose		Radius
	Boom Extension		Boom Length
	Speed		Hookblock
	Grade		Gear
	Lattice Extension		