



GROVE[®]
CRANE

A GROVE WORLDWIDE COMPANY

LOAD CHART

AT990E

IDENTIFICATION
AT990E

SERIAL NUMBER
84057

CONTENTS

REF 1 OF GA 1426	- TITLE PAGE	
REF 2 OF GA 1426	- CONTENTS	
REF 3 OF GA 1426	- IMPORTANT NOTES	
REF 4 OF GA 1426	- IMAGES FOR GRAPHIC CONSOLE	
REF 5 OF GA 1426	- MAIN BOOM - MODE 'A'	- OUTRIGGERS FULLY EXTENDED - 11.85 TONNES COUNTERWEIGHT
REF 6 OF GA 1426	- MAIN BOOM - MODE 'B'	- OUTRIGGERS FULLY EXTENDED - 11.85 TONNES COUNTERWEIGHT
REF 7 OF GA 1426	- JIB EXTENSION - WITH 45.00M MAIN BOOM	- OUTRIGGERS FULLY EXTENDED - 11.85 TONNES COUNTERWEIGHT
REF 8 OF GA 1426	- JIB EXTENSION - WITH 42.00M MAIN BOOM	- OUTRIGGERS FULLY EXTENDED - 11.85 TONNES COUNTERWEIGHT
REF 9 OF GA 1426	- MAIN BOOM - MODE 'A'	- 2.00 TONNES COUNTERWEIGHT
REF 10 OF GA 1426	- MAIN BOOM - MODE 'B'	- 2.00 TONNES COUNTERWEIGHT
REF 11 OF GA 1426	- JIB EXTENSION - WITH 45.00M MAIN BOOM	- OUTRIGGERS FULLY EXTENDED - 2.00 TONNES COUNTERWEIGHT
REF 12 OF GA 1426	- JIB EXTENSION - WITH 42.00M MAIN BOOM	- OUTRIGGERS FULLY EXTENDED - 2.00 TONNES COUNTERWEIGHT
REF 13 OF GA 1426	- RANGE DIAGRAM	
	- WEIGHT REDUCTION AND LOAD HANDLING DEVICES	
	- LINE PULLS AND REEVING INFORMATION	
REF 14 OF GA 1426	- WORKING AREA DIAGRAM	

IDENTIFICATION AT990E SERIAL NUMBER 84057

LIFTING CAPACITY NOTES

GENERAL:-

1. RATED LOADS AS SHOWN ON THE CAPACITY CHART PERTAIN TO THIS MACHINE AS ORIGINALLY MANUFACTURED AND EQUIPPED. MODIFICATIONS TO THE MACHINE OR USE OF OPTIONAL EQUIPMENT OTHER THAN SPECIFIED CAN RESULT IN A REDUCTION OF CAPACITY.
2. CONSTRUCTION EQUIPMENT CAN BE HAZARDOUS IF IMPROPERLY OPERATED OR MAINTAINED. INFORMATION AND MAINTENANCE OF THIS MACHINE SHALL BE IN COMPLIANCE WITH THE OPERATORS AND SAFETY HAND BOOK, SERVICE AND PARTS MANUALS SUPPLIED WITH THE MACHINE. IF THESE MANUALS ARE MISSING, ORDER REPLACEMENTS FROM THE MANUFACTURER THROUGH THE DISTRIBUTOR.
3. THE OPERATOR AND OTHER PERSONNEL ASSOCIATED WITH THIS CRANE SHALL FULLY ACQUAINT THEMSELVES WITH THE LATEST APPLICABLE NATIONAL SAFETY STANDARDS FOR CRANES.

SET - UP:-

1. THE MACHINE SHALL BE LEVELLED ON A FIRM SUPPORTING SURFACE. DEPENDING ON THE NATURE OF THE SUPPORTING SURFACE, IT MAY BE NECESSARY TO HAVE STRUCTURAL SUPPORTS UNDER THE OUTRIGGER FLOATS OR TYRES TO SPREAD THE LOAD TO A LARGER BEARING SURFACE.
2. FOR OUTRIGGER OPERATION, OUTRIGGERS SHALL BE EXTENDED TO THE RECOMMENDED CENTRES IN ACCORDANCE WITH THE OPERATORS MANUAL, WITH TYRES RAISED FREE OF CRANE WEIGHT BEFORE OPERATING THE BOOM OR LIFTING LOADS.
3. IF THE MACHINE IS EQUIPPED WITH A FRONT JACK CYLINDER, THE CYLINDER SHALL BE SET IN ACCORDANCE WITH THE WRITTEN PROCEDURE.
4. IF THE MACHINE IS EQUIPPED WITH EXTENDABLE COUNTERWEIGHT, THE COUNTERWEIGHT SHALL BE EXTENDED BEFORE OPERATION.
5. TYRES SHALL BE INFLATED TO THE RECOMMENDED PRESSURE BEFORE LIFTING ON RUBBER.
6. WITH CERTAIN BOOM AND HOIST TACKLE COMBINATIONS, MAXIMUM CAPACITIES MAY NOT BE OBTAINABLE WITH STANDARD CABLE LENGTHS.
7. DO NOT TRAVEL WITH CRANE BOOM EXTENSION OR JIB ERRECTED.

1. RATED LOADS AT RATED RADIUS SHALL NOT BE EXCEEDED. DO NOT TIP MACHINE TO DETERMINE ALLOWABLE LOADS. FOR CLAMSHELL OR CONCRETE BUCKET OPERATION, WEIGHT OF THE BUCKET AND LOAD MUST NOT EXCEED 80% OF RATED LIFTING CAPACITIES.
2. RATED LOADS INCLUDE THE WEIGHT OF THE HOOKBLOCK, SLINGS AND AUXILIARY LIFTING DEVICES AND THEIR COMBINED WEIGHT SHALL BE SUBTRACTED FROM THE LISTED RATINGS TO OBTAIN THE NET LOADS TO BE LIFTED. WHEN MORE THAN THE MINIMUM REQUIRED HOIST REEVING IS USED, THE ADDITIONAL ROPE WEIGHT SHALL BE CONSIDERED PART OF THE LOAD TO BE LIFTED.

3. LOAD RATINGS ARE BASED ON FREELY SUSPENDED LOADS. NO ATTEMPT SHALL BE MADE TO MOVE THE LOAD HORIZONTALLY ON THE GROUND IN ANY DIRECTION.
4. RATED LOADS DO NOT ACCOUNT FOR WIND ON LIFTED LOAD OR BOOM. IT IS RECOMMENDED THAT THE RATED LOADS AND BOOM LENGTHS BE APPROPRIATELY REDUCED WHEN WIND VELOCITY IS ABOVE 20 M.P.H. (32 KM.P.H.).
5. RATED LOADS ARE FOR LIFT CRANE SERVICE ONLY.

6. DO NOT OPERATE AT A RADIUS OR BOOM LENGTH WHERE CAPACITIES ARE NOT LISTED. AT THESE POSITIONS THE MACHINE MAY OVERTURN WITHOUT ANY LOAD ON THE HOOK.
7. THE MAXIMUM LOAD WHICH CAN BE TELESCOPED IS NOT DEFINABLE BECAUSE OF VARIATIONS IN LOADING AND CRANE MAINTENANCE, BUT IT IS SAFE TO ATTEMPT RETRACTION AND EXTENSION WITHIN THE LIMITS OF THE CAPACITY CHART.
8. WHEN EITHER BOOM LENGTH OR RADIUS OR BOTH ARE BETWEEN VALUES LISTED, THE SMALLEST LOAD SHOWN AT EITHER THE NEXT LARGER RADIUS OR BOOM LENGTH SHALL BE USED.

9. FOR SAFE OPERATION, THE USER SHALL MAKE DUE ALLOWANCE FOR HIS PARTICULAR JOB CONDITION, SUCH AS: SOFT OR UNEVEN GROUND, OUT OF LEVEL CONDITIONS, HIGH WINDS, SIDE LOADS, PENDULUM ACTION, JERKING OR SUDDEN STOPPING OF LOADS, HAZARDOUS CONDITIONS, EXPERIENCE OF PERSONNEL, TWO MACHINE LIFTS, TRAVELLING WITH LOADS, ELECTRIC WIRES, ETC. SIDE PULL ON BOOM OR JIB IS EXTREMELY DANGEROUS.
10. THIS CRANE MUST BE OPERATED IN MODE 'A' OR MODE 'B' AND THE BOOM SECTIONS MUST ONLY BE EXTENDED IN THE SEQUENCE SHOWN ON THE CAPACITY CHART.
11. HANDLING OF PERSONNEL FROM THE BOOM IS NOT AUTHORISED EXCEPT WITH EQUIPMENT FURNISHED AND INSTALLED BY GROVE.
12. KEEP LOAD HANDLING DEVICES A MINIMUM OF 30 CM BELOW BOOM HEAD WHEN LOWERING OR EXTENDING BOOM.

13. LOADED BOOM ANGLES GIVE AN APPROXIMATION OF THE OPERATING RADIUS AT SPECIFIED BOOM LENGTHS. THE BOOM ANGLE BEFORE LOADING SHOULD BE GREATER TO ACCOUNT FOR DEFLECTION.
14. CAPACITIES ARE IN TONNES AND DO NOT EXCEED 85% OF THE TIPPING LOAD AS DETERMINED BY TEST IN ACCORDANCE WITH SAE J 765.
15. CAPACITIES FOR THE 12.07M BOOM LENGTHS ARE VALID ONLY FOR THE FULLY RETRACTED BOOM. IF THE BOOM IS NOT FULLY RETRACTED, CAPACITIES SHALL NOT EXCEED THOSE SHOWN FOR THE NEXT APPLICABLE BOOM LENGTH.
16. RADII LESS THAN 9 METRES ARE NOT RECOMMENDED WHEN LIFTING OVER FRONT OF MACHINE.

17. CAPACITIES APPEARING ABOVE THE BOLD LINE ARE BASED ON STRUCTURAL STRENGTH AND TIPPING SHOULD NOT BE RELIED UPON AS A CAPACITY LIMITATION. DEFINITIONS:-
 1. OPERATING RADIUS:- HORIZONTAL DISTANCE FROM A PROJECTION OF THE AXIS OF ROTATION OF THE SUPPORTING SURFACE, BEFORE LOADING, TO CENTRE OF THE VERTICAL HOIST LINE OR TACKLE WITH LOAD APPLIED.
 2. LOADED BOOM ANGLE:- THE ANGLE BETWEEN THE BOOM BASE SECTION AND THE HORIZONTAL AFTER LIFTING THE RATED LOAD AT THE RATED RADIUS.
 3. WORKING AREA:- FOR A GIVEN OPERATING RADIUS, THE AREA MEASURED IN A CIRCULAR ARC ABOUT THE CENTRE LINE OF ROTATION AS SHOWN ON THE AREA DIAGRAM.
 4. FREELY SUSPENDED LOAD:- LOAD HANGING FREE WITH NO DIRECT EXTERNAL FORCE APPLIED EXCEPT BY THE LIFT CABLE.
 5. SIDE LOAD:- HORIZONTAL FORCE APPLIED TO THE LIFTED LOAD EITHER ON THE GROUND OR IN THE AIR.

IMAGES FOR GRAPHIC CONSOLE

BOOM EXTENSIONS

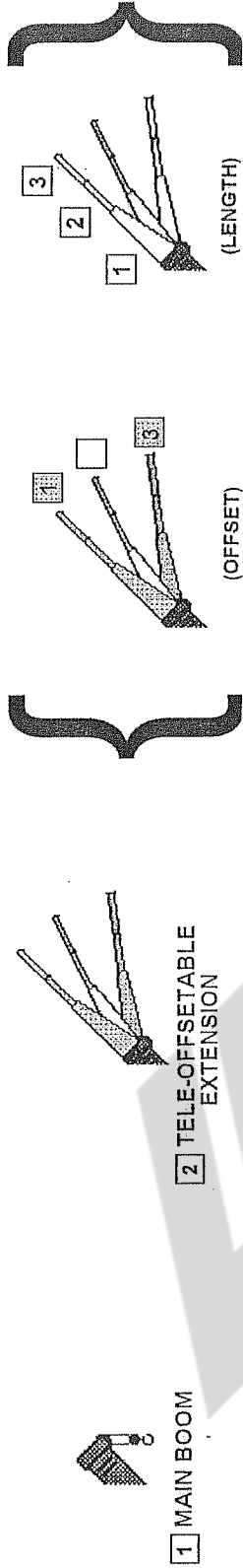

COUNTERWEIGHT OPTIONS



OUTRIGGER CONFIGURATIONS

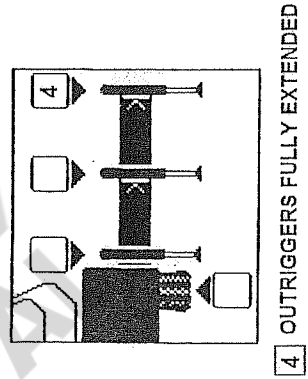

IDENTIFICATION AT990E SERIAL NUMBER 84057

**PART " A " COUNTERWEIGHT - 11.85 TONNES
OUTRIGGERS FULLY EXTENDED AT 7.20M**

LIFTING CAPACITIES IN TONNES

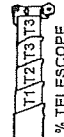
L.M.I. CODE	# 0101				
	MODE ' A '				
RADIUS	MAIN BOOM IN METRES - 360°				
	180° OVER REAR ONLY	12.07	20.30	28.53	34.02
3.00	80.00 *	75.00			
3.50	65.00	65.00			
4.00	59.30	59.30	31.20	21.30	
4.50	54.50	54.50	31.20	21.30	17.10
5.00	50.30	50.30	31.20	21.30	16.80
6.00	43.30	43.30	31.20	21.20	16.30
7.00	36.10	36.10	28.70	20.20	15.70
8.00	30.70	30.70	26.20	19.40	15.00
9.00	24.90	24.90	24.00	18.30	14.30
10.00	SEE WARNING NOTE 15	SEE WARNING NOTE 15	22.20	16.80	13.70
12.00			18.10	14.40	12.50
14.00			13.70	12.40	10.90
16.00			10.60	10.90	9.55
18.00				9.60	8.45
20.00				8.00	7.50
22.00				6.60	6.70
24.00				5.45	5.95
26.00					5.00
28.00					4.20
30.00					3.55
LOW ANGLE CAPACITY (REF RAD)	24.90	24.90	9.50	5.00	3.50
	(9.00)	(9.00)	(16.90)	(24.80)	(30.10)
 % TELESCOPE	T1	0	0	0	0
	T2	0	0	100	100
	T3	0	0	0	50

* 180° OVER REAR ONLY WITH HEAVY LIFT EQUIPMENT
L.M.I. OPERATING CODE REFER TO L.M.I. MANUAL FOR INSTRUCTIONS
AT990E/65%/12/11/84/01

NOTE:- () REFERENCE RADIUS IN METRES FOR LOW ANGLE CAPACITIES.
CAPACITIES ABOVE THE BOLD LINE ARE BASED ON STRUCTURAL STRENGTH AND BELOW THE LINE DO NOT EXCEED 85% OF THE TIPPING LOAD AS DETERMINED BY TEST IN ACCORDANCE WITH SAE J 765.
NOTE:- WHEN LIFTING OVER AUXILIARY BOOM NOSE, CAPACITIES OF MAIN BOOM, LESS THE REDUCTION FOR FITMENT OF AUXILIARY BOOM NOSE SHALL APPLY. THE MAXIMUM CAPACITY SHALL NOT EXCEED THE AUXILIARY HOIST SINGLE LINE PULL.

IDENTIFICATION SERIAL NUMBER
AT990E 84057



1 MAIN BOOM

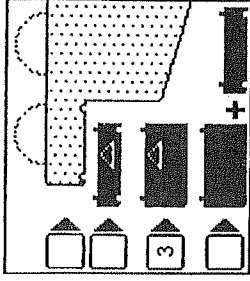

3 WITH 11.85 TONNES COUNTERWEIGHT

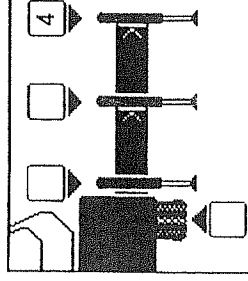

4 OUTRIGGERS FULLY EXTENDED



WARNING

BELOW 20° BOOM ANGLES, GREAT CARE MUST BE EXERCISED WHEN SLEWING OR DERRICKING DOWN TO AVOID DAMAGING CHASSIS EQUIPMENT E.G. CAB, EXHAUST, BOOM REST ETC.
9-776

**PART " A " COUNTERWEIGHT - 11.85 TONNES
OUTRIGGERS FULLY EXTENDED AT 7.20M**

LIFTING CAPACITIES IN TONNES

L.M.I. CODE		# 0101										
RADIUS		MODE ' B '										
IN		MAIN BOOM IN METRES - 360°										
METRES		180° OVER REAR ONLY	12.07	17.55	20.30	23.04	28.53	34.02	39.51	45.00		
3.00	80.00 *	75.00	46.90	46.40	45.40							
3.50	65.00	55.00	46.90	46.40	43.10							
4.00	59.30	59.30	46.90	46.40	41.00	26.10						
4.50	54.50	54.50	46.90	43.80	39.10	26.10	21.20					
5.00	50.30	50.30	44.50	41.50	37.30	26.10	21.20					
6.00	43.30	43.30	40.20	37.30	34.10	26.10	21.20	17.00				
7.00	36.10	36.10	35.00	33.90	31.10	25.30	20.80	17.00	11.00			
8.00	30.70	30.70	29.60	29.80	28.10	23.00	19.50	17.00	11.00			
9.00	24.90	24.90	25.40	25.60	25.70	20.80	18.30	16.50	11.00			
10.00	SEE WARNING NOTE 15	SEE WARNING NOTE 15	22.10	22.20	22.40	18.90	17.30	15.90	11.00			
12.00	SEE WARNING NOTE 15	SEE WARNING NOTE 15	16.85	17.05	17.20	15.80	14.50	13.60	10.60			
14.00			12.45	12.70	12.85	12.70	12.30	11.60	9.90			
16.00			9.65	9.80	9.65	9.65	10.50	9.90	9.20			
18.00				7.55	7.40	7.40	8.40	8.60	7.90			
20.00					5.65	5.65	6.60	7.30	7.00			
22.00					4.25	4.25	5.20	5.85	6.30			
24.00					3.15	3.15	4.10	4.75	5.20			
26.00							3.15	3.80	4.25			
28.00								2.40	3.00			
30.00								1.65	2.35			
32.00									1.75	2.25		
34.00									1.15	1.75		
36.00										1.20		
38.00											0.75	
LOW ANGLE CAPACITY (REF RAD)	24.90 (9.00)	24.90 (9.00)	12.00 (14.20)	8.55 (16.90)	6.15 (19.50)	2.75 (24.80)	1.60 (30.10)	0.80 (35.30)	0.80 (40.20)	0.80 (45.00)		
T1	0	0	67	67	67	100	100	100	100	100		
T2	0	0	0	33	67	100	100	100	100	100		
T3	0	0	0	0	0	0	33	67	100	100		
% TELESCOPE												

AT990E/BS%/12/1194/02

* 180° OVER REAR ONLY WITH HEAVY LIFT EQUIPMENT

L.M.I. OPERATING CODE REFER TO L.M.I. MANUAL FOR INSTRUCTIONS

NOTE:- () REFERENCE RADII IN METRES FOR LOW ANGLE CAPACITIES.

CAPACITIES ABOVE THE BOLD LINE ARE BASED ON STRUCTURAL STRENGTH AND BELOW THE LINE DO NOT EXCEED 85% OF THE TIPPING LOAD AS DETERMINED BY TEST IN ACCORDANCE WITH SAE J 765.

NOTE:- WHEN LIFTING OVER AUXILIARY BOOM NOSE, CAPACITIES OF MAIN BOOM, LESS THE REDUCTION FOR FITMENT OF AUXILIARY BOOM NOSE SHALL APPLY. THE MAXIMUM CAPACITY SHALL NOT EXCEED THE AUXILIARY HOIST SINGLE LINE PULL.

IDENTIFICATION

AT990E

84057



1 MAIN BOOM

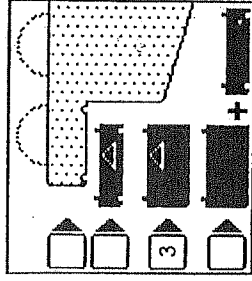

3 WITH 11.85 TONNES COUNTERWEIGHT

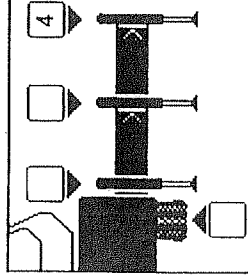

4 OUTRIGGERS FULLY EXTENDED

WARNING

BELOW 20° BOOM ANGLES, GREAT CARE MUST BE TAKEN TO AVOID DAMAGING EQUIPMENT E.G. CAB, EXHAUST, BOOM REST ETC.

9-776

**PART " A " COUNTERWEIGHT - 11.85 TONNES
OUTRIGGERS FULLY EXTENDED AT 7.20M**

LIFTING CAPACITIES IN TONNES - 360°

L.M.I. CODE	REF. RADIUS IN METRES	# 0121		# 0123		# 0131		# 0133		# 0141		# 0143	
		9.68M LENGTH		13.34M LENGTH		17.00M LENGTH		17.00M LENGTH		17.00M LENGTH		17.00M LENGTH	
		0° OFFSET	30° OFFSET	0° OFFSET	30° OFFSET	0° OFFSET	30° OFFSET	0° OFFSET	30° OFFSET	0° OFFSET	30° OFFSET	0° OFFSET	30° OFFSET
		L°	LOAD	L°	LOAD	L°	LOAD	L°	LOAD	L°	LOAD	L°	LOAD
9.00		MAX	6.00										
10.00		81.0°	5.50			MAX	3.90						
12.00		79.0°	4.80	MAX	3.40	80.5°	3.60			MAX	2.75		
14.00		77.0°	4.35	80.5°	3.30	78.0°	3.30			80.0°	2.50		
16.00		75.0°	4.00	78.5°	3.15	76.5°	3.05	81.0°	2.00	78.0°	2.30		
18.00		73.0°	3.65	76.5°	3.00	74.5°	2.75	79.5°	1.95	76.0°	2.05	MAX	1.25
20.00		70.5°	3.30	74.0°	2.80	72.5°	2.50	77.5°	1.85	74.0°	1.85	80.0°	1.15
22.00		68.5°	3.00	71.5°	2.55	70.5°	2.25	75.0°	1.75	72.0°	1.65	78.5°	1.13
24.00		66.0°	2.75	69.5°	2.30	68.5°	2.05	73.0°	1.70	70.0°	1.50	76.0°	1.10
26.00		63.5°	2.50	67.0°	2.10	67.0°	1.86	70.5°	1.60	68.0°	1.30	74.5°	1.05
28.00		61.0°	2.25	65.0°	1.95	64.0°	1.65	69.5°	1.55	66.0°	1.10	72.0°	1.00
30.00		58.5°	2.05	62.5°	1.80	61.5°	1.45	66.5°	1.50	64.0°	1.00	70.0°	0.95
32.00		56.0°	1.85	59.5°	1.75	59.0°	1.25	64.0°	1.35	62.0°	0.85	68.0°	0.85
34.00		53.0°	1.60	57.0°	1.65	56.5°	1.10	61.5°	1.20	59.5°	0.65	65.5°	0.75
36.00		50.5°	1.40	54.0°	1.45	54.0°	0.90	59.0°	1.05	57.5°	0.55	63.5°	0.64
38.00		47.0°	1.00	51.0°	1.35	51.5°	0.80	56.5°	0.90	55.0°	0.55	61.0°	0.55
40.00		44.0°	0.60	47.0°	0.95	48.5°	0.65	53.5°	0.85	50.5°	0.70		
42.00								47.0°	0.60				
44.00								43.0°	0.60				
MINIMUM BOOM ANGLE		40.5° (41.90M)	41.0° (43.20M)	42.0° (44.20M)	43.0° (46.20M)	43.0° (46.20M)	43.0° (46.20M)	43.0° (46.20M)	43.0° (46.20M)	43.0° (46.20M)	43.0° (46.20M)	43.0° (46.20M)	58.5° (40.00M)

L.M.I. OPERATING CODE REFER TO L.M.I. MANUAL FOR INSTRUCTIONS AT990E65%/121164/20

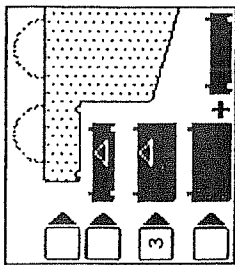

3 WITH 11.85 TONNES COUNTERWEIGHT

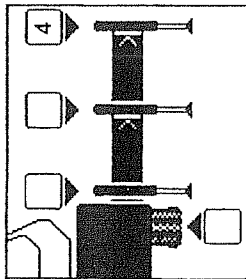

4 OUTRIGGERS FULLY EXTENDED

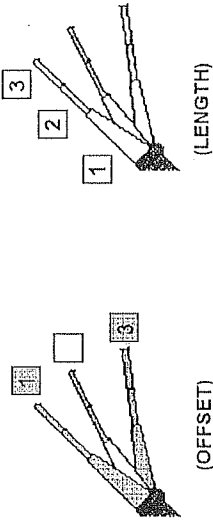
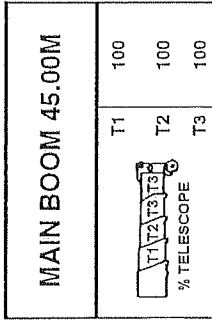

EXT OFFSET	EXT LENGTH	PAT SELECTION	
		EXT OFFSET	EXT LENGTH
2°	9.68M	1	1
30°		3	
2°	13.34M	1	2
30°		3	
2°	17.00M	1	3
30°		3	

1. ALL CAPACITIES ABOVE THE BOLD LINE ARE BASED ON STRUCTURAL STRENGTH OF THE EXTENSION AND BELOW THE LINE DO NOT EXCEED 85% OF THE TIPPING LOAD AS DETERMINED BY TEST IN ACCORDANCE WITH SAE J766.
 2. RATED LOAD IS BASED ON LOADED MAIN BOOM ANGLE WITH REFERENCE TO HORIZONTAL, REGARDLESS OF MAIN BOOM LENGTH QUOTED. (REF. RADIUS IN METRES IS FOR BOOM LENGTH SHOWN ABOVE ONLY).
 WARNING:-
 OPERATION OF THIS MACHINE WITH HEAVIER LOADS THAN THE CAPACITIES LISTED IS STRICTLY PROHIBITED. MACHINE TIPPING WITH THE EXTENSION OCCURS RAPIDLY AND WITHOUT WARNING. REMOVE ALL REEVEING / RIGGING ACCESSORIES FROM MAIN BOOM WHEN USING THE EXTENSION.
 3. 9.68M - 17.00M TELE OFFSETABLE BOOM EXTENSION WARNING:- WITH THE EXTENSION IN THE WORKING POSITION, THE MAIN BOOM MUST BE FULLY RETRACTED FOR BOOM ANGLES LESS THAN THOSE SHOWN ON THE LOAD CHART FOR THAT PARTICULAR EXTENSION LENGTH AND OFFSET. THIS WARNING ALSO APPLIES FOR BOOM EXTENSION ERECTION PURPOSES.

**PART " A " COUNTERWEIGHT - 11.85 TONNES
OUTRIGGERS FULLY EXTENDED AT 7.20M**

LIFTING CAPACITIES IN TONNES - 360°

L.M.I. CODE	# 0121		# 0123		# 0131		# 0133		# 0141		# 0143	
	9.68M LENGTH				13.34M LENGTH				17.00M LENGTH			
	0° OFFSET		30° OFFSET		0° OFFSET		30° OFFSET		0° OFFSET		30° OFFSET	
REF. RADIUS IN METRES	L°	LOAD	L°	LOAD	L°	LOAD	L°	LOAD	L°	LOAD	L°	LOAD
8.00	MAX	6.80										
9.00	81.0°	6.50										
10.00	80.0°	6.30			MAX	5.10						
12.00	78.0°	6.00	MAX	3.40	79.5°	4.75			81.0°	3.50		
14.00	76.0°	5.70	79.5°	3.20	77.5°	4.40	MAX	2.05	79.0°	3.25		
16.00	74.0°	5.20	77.0°	3.05	75.5°	4.00	80.0°	1.95	77.0°	3.00		
18.00	71.5°	4.80	74.5°	2.90	73.5°	3.70	78.0°	1.90	75.0°	2.80	81.0°	1.25
20.00	69.0°	4.40	72.5°	2.80	71.0°	3.40	76.0°	1.80	73.0°	2.55	79.0°	1.15
22.00	66.5°	4.05	70.0°	2.65	69.0°	3.10	73.5°	1.70	71.0°	2.30	77.0°	1.10
24.00	64.0°	3.70	67.5°	2.55	66.5°	2.85	71.0°	1.64	69.0°	2.05	75.0°	1.07
26.00	61.5°	3.40	65.0°	2.45	64.5°	2.60	69.0°	1.57	66.5°	1.85	72.5°	1.04
28.00	59.0°	3.15	62.0°	2.35	62.0°	2.40	66.5°	1.50	64.5°	1.70	70.5°	1.00
30.00	56.5°	2.90	59.5°	2.25	59.5°	2.20	64.0°	1.45	62.0°	1.50	68.0°	0.97
32.00	53.0°	2.35	56.5°	2.15	57.0°	2.00	61.5°	1.40	60.0°	1.35	66.0°	0.95
34.00	50.0°	1.85	53.5°	2.05	54.0°	1.80	58.5°	1.35	57.5°	1.25	63.5°	0.90
36.00	48.5°	1.35	50.0°	1.70	51.5°	1.60	56.0°	1.29	55.0°	1.15	61.0°	0.85
38.00	43.0°	0.90	46.5°	1.25	48.5°	1.30	53.0°	1.25	52.5°	1.00	58.0°	0.80
40.00			42.5°	0.75	45.0°	0.90	49.5°	1.20	49.5°	0.90	55.5°	0.70
42.00							46.0°	0.90	46.5°	0.75	52.5°	0.60
44.00							43.5°	0.60	43.5°	0.60		
MINIMUM BOOM ANGLE		39.5° (40.00M)	40.5° (41.20M)	41.5° (42.00M)	42.5° (44.40M)	42.5° (42.00M)	40.0° (46.10M)	52.0° (42.30M)				

L.M.I. OPERATING CODE REFER TO L.M.I. MANUAL FOR INSTRUCTIONS AT606/85%72/19/22

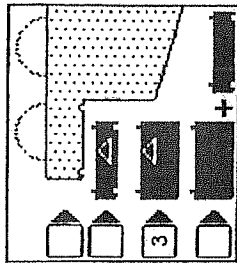

3 WITH 11.85 TONNES COUNTERWEIGHT

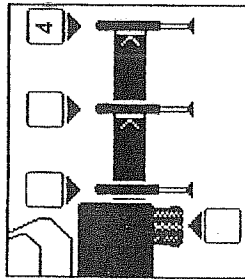

4 OUTRIGGERS FULLY EXTENDED

MAIN BOOM 42.00M			
T1	100		
T2	100		
T3	82		

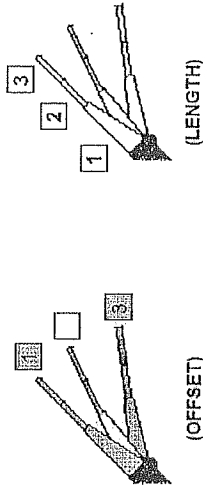

EXT OFFSET	EXT LENGTH	PAT SELECTION	
		EXT OFFSET	EXT LENGTH
2°	9.68M	1	1
30°		3	
2°	13.34M	1	2
30°		3	
2°	17.00M	1	3
30°		3	

1. ALL CAPACITIES ABOVE THE BOLD LINE ARE BASED ON STRUCTURAL STRENGTH OF THE EXTENSION AND BELOW THE LINE DO NOT EXCEED 85% OF THE TIPPING LOAD AS DETERMINED BY TEST IN ACCORDANCE WITH SAE J765.
 2. RATED LOAD IS BASED ON LOADED MAIN BOOM ANGLE WITH REFERENCE TO HORIZONTAL, REGARDLESS OF MAIN BOOM LENGTH QUOTED. (REF. RADIUS IN METRES IS FOR BOOM LENGTH SHOWN ABOVE ONLY).
 WARNING:-
 OPERATION OF THIS MACHINE WITH HEAVIER LOADS THAN THE CAPACITIES LISTED IS STRICTLY PROHIBITED. MACHINE TIPPING WITH THE EXTENSION OCCURS RAPIDLY AND WITHOUT WARNING. REMOVE ALL REEVING / RIGGING ACCESSORIES FROM MAIN BOOM WHEN USING THE EXTENSION.
 3. 9.68M - 17.00M TELE OFFSETABLE BOOM EXTENSION WARNING:- WITH THE EXTENSION IN THE WORKING POSITION, THE MAIN BOOM MUST BE FULLY RETRACTED FOR BOOM ANGLES LESS THAN THOSE SHOWN ON THE LOAD CHART FOR THAT PARTICULAR EXTENSION LENGTH AND OFFSET. THIS WARNING ALSO APPLIES FOR BOOM EXTENSION ERECTION PURPOSES.

**IDENTIFICATION SERIAL NUMBER
AT990E 84057**

**PART " B " COUNTERWEIGHT - 2.00 TONNES
OUTRIGGERS FULLY EXTENDED AT 7.20M**

LIFTING CAPACITIES IN TONNES

L.M.I. CODE	# 0201		MODE ' A '			
	180° OVER REAR ONLY	MAIN BOOM IN METRES - 360°				
RADIUS		12.07	20.30	28.53	34.02	
METRES		12.07	20.30	28.53	34.02	
3.00	80.00 *	70.00				
3.50	63.30	63.30				
4.00	57.80	57.80	31.20	21.30		
4.50	53.00	53.00	31.20	21.30	17.10	
5.00	47.10	47.10	31.20	21.30	16.80	
6.00	38.00	38.00	31.20	21.20	16.30	
7.00	31.60	31.60	28.70	20.20	15.70	
8.00	26.70	26.70	26.20	19.40	15.00	
9.00	21.55	21.55	21.80	18.30	14.30	
10.00	SEE WARNING NOTE 15	SEE WARNING NOTE 15	17.80	16.80	13.70	
12.00	SEE WARNING NOTE 15	SEE WARNING NOTE 15	12.15	13.95	12.50	
14.00	SEE WARNING NOTE 15	SEE WARNING NOTE 15	8.65	10.25	10.90	
16.00			6.20	7.80	8.40	
18.00				6.00	6.55	
20.00				4.65	5.20	
22.00				3.55	4.10	
24.00				2.70	3.25	
26.00					2.55	
28.00					1.95	
30.00					1.40	
LOW ANGLE CAPACITY	21.55	21.55	5.35	2.40	1.40	
(REFRAD)	(9.00)	(9.00)	(16.90)	(24.80)	(30.10)	
T1	0	0	0	0	0	0
T2	0	0	100	100	100	100
T3	0	0	0	50	83	83

* 180° OVER REAR ONLY WITH HEAVY LIFT EQUIPMENT AT990E/5%2A119401
L.M.I. OPERATING CODE REFER TO L.M.I. MANUAL FOR INSTRUCTIONS

NOTE:- () REFERENCE RADIUS IN METRES FOR LOW ANGLE CAPACITIES.
CAPACITIES ABOVE THE BOLD LINE ARE BASED ON STRUCTURAL STRENGTH AND BELOW THE LINE DO NOT EXCEED 85% OF THE TIPPING LOAD AS DETERMINED BY TEST IN ACCORDANCE WITH SAE J 765.
NOTE:- WHEN LIFTING OVER AUXILIARY BOOM NOSE, CAPACITIES OF MAIN BOOM, LESS THE REDUCTION FOR FITMENT OF AUXILIARY BOOM NOSE SHALL APPLY. THE MAXIMUM CAPACITY SHALL NOT EXCEED THE AUXILIARY HOIST SINGLE LINE PULL.



1 MAIN BOOM

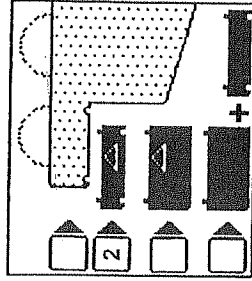

2 WITH 2.00 TONNES COUNTERWEIGHT

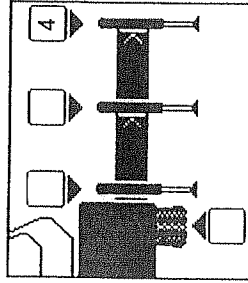

4 OUTRIGGERS FULLY EXTENDED

WARNING

BELOW 20° BOOM ANGLES, GREAT CARE MUST BE EXERCISED WHEN SLEWING OR DEBRICKING DOWN TO AVOID DAMAGING CHASSIS EQUIPMENT. E.G. CAB, EXHAUST, BOOM REST, ETC. 9-776

IDENTIFICATION
AT990E

SERIAL NUMBER
84057

**PART " B " COUNTERWEIGHT - 2.00 TONNES
OUTRIGGERS FULLY EXTENDED AT 7.20M**

LIFTING CAPACITIES IN TONNES

L.M.I. CODE	# 0201											
	MODE ' B '											
RADIUS IN METRES	MAIN BOOM IN METRES - 360°											
	180° OVER REAR ONLY	12.07	17.55	20.30	23.04	28.53	34.02	39.51	45.00			
3.00	80.00 *	70.00	46.90	46.40	45.40							
3.50	63.30	63.30	46.90	46.40	43.10							
4.00	57.80	57.80	46.90	46.40	41.00	26.10						
4.50	53.00	53.00	46.90	43.80	39.10	26.10	21.20					
5.00	47.10	47.10	44.50	41.50	37.30	26.10	21.20	17.00				
6.00	38.00	38.00	36.90	37.10	34.10	26.10	21.20	17.00				
7.00	31.60	31.60	30.50	30.70	30.80	25.30	20.80	17.00				
8.00	26.70	26.70	25.70	25.80	26.00	23.00	19.50	17.00				
9.00	21.55	21.55	20.30	20.50	20.70	20.50	18.30	16.50	11.00			
10.00	SEE WARNING NOTE 15	SEE WARNING NOTE 15	16.30	16.60	16.80	16.60	17.30	15.90	11.00			
12.00	10.80	10.80	11.05	11.05	11.05	12.20	13.05	10.60				
14.00	7.30	7.30	7.60	7.60	7.75	7.60	8.65	9.45	9.90			
16.00			5.20	5.40	5.25	6.25	7.00	7.55				
18.00				3.70	3.55	4.50	5.25	5.75				
20.00					2.25	3.20	3.90	4.40				
22.00					1.05	2.20	2.85	3.35				
24.00					1.25	2.00	2.50	2.90				
26.00						1.20	1.60	2.00				
28.00							1.10	1.50				
LOW ANGLE CAPACITY (REF RAD)	21.55 (9.00)	6.95 (14.20)	4.40 (16.90)	2.65 (19.50)								
T1	0	67	67	67	67	67	67	67	67	67	67	67
T2	0	0	33	33	33	33	33	33	33	33	33	33
T3	0	0	0	0	0	0	0	0	0	0	0	0
% TELESCOPE												
MINIMUM BOOM ANGLE												
					22.5 (23.60)	31.5 (28.60)	38.0 (33.60)	42.5 (36.50)				

* 180° OVER REAR ONLY WITH HEAVY LIFT EQUIPMENT
L.M.I. OPERATING CODE REFER TO L.M.I. MANUAL FOR INSTRUCTIONS

NOTE:- () REFERENCE RADIUS IN METRES FOR LOW ANGLE CAPACITIES.
CAPACITIES ABOVE THE BOLD LINE ARE BASED ON STRUCTURAL STRENGTH AND BELOW THE LINE DO NOT EXCEED 85% OF THE TIPPING LOAD AS DETERMINED BY TEST IN ACCORDANCE WITH SAE J 765.
NOTE:- WHEN LIFTING OVER AUXILIARY BOOM NOSE, CAPACITIES OF MAIN BOOM, LESS THE REDUCTION FOR FITMENT OF AUXILIARY BOOM NOSE SHALL APPLY. THE MAXIMUM CAPACITY SHALL NOT EXCEED THE AUXILIARY HOIST SINGLE LINE PULL.

IDENTIFICATION SERIAL NUMBER
AT990E 84057



1 MAIN BOOM

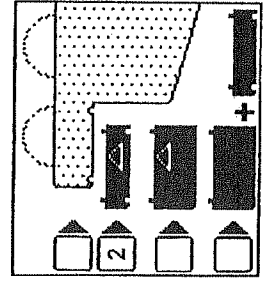

2 WITH 2.00 TONNES COUNTERWEIGHT

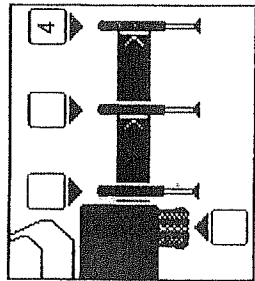

4 OUTRIGGERS FULLY EXTENDED

WARNING

BELOW 20° BOOM ANGLES, GREAT CARE MUST BE EXERCISED WHEN SLEWING OR DERRICKING DOWN TO AVOID DAMAGING CHASSIS EQUIPMENT
E.G. CAB, EXHAUST, BOOM REST ETC.
9-776

**PART " B " COUNTERWEIGHT - 2.00 TONNES
OUTRIGGERS FULLY EXTENDED AT 7.20M**

LIFTING CAPACITIES IN TONNES - 360°

L.M.I. CODE	# 0221	# 0223		# 0231		# 0233		# 0241		# 0243
		9.68M LENGTH		13.34M LENGTH		17.00M LENGTH		17.00M LENGTH		
		0° OFFSET	30° OFFSET	0° OFFSET	30° OFFSET	0° OFFSET	30° OFFSET	0° OFFSET	30° OFFSET	
REF. RADIUS IN METRES	L°	LOAD	L°	LOAD	L°	LOAD	L°	LOAD	L°	LOAD
9.00	MAX	6.00								
10.00	81.0°	5.50		MAX	3.90					
12.00	79.0°	4.80	MAX	80.5°	3.60		MAX	2.75		
14.00	77.0°	4.35	80.5°	3.30	3.30		80.0°	2.50		
16.00	75.0°	4.00	78.5°	3.15	3.05	81.0°	2.00	2.30		
18.00	73.0°	3.65	76.5°	3.00	2.75	79.5°	1.95	2.05	MAX	1.25
20.00	70.5°	3.30	74.0°	2.80	2.50	77.5°	1.85	1.65	80.0°	1.15
22.00	68.5°	3.00	71.5°	2.55	2.25	75.0°	1.75	1.65	78.5°	1.13
24.00	66.0°	2.70	69.5°	2.30	2.05	73.0°	1.70	1.50	76.0°	1.10
26.00	63.5°	2.00	67.0°	2.10	1.85	70.5°	1.60	1.30	74.5°	1.05
28.00	61.0°	1.35	64.0°	1.95	1.65	68.0°	1.55	1.10	72.0°	1.00
30.00	58.5°	0.75	62.5°	1.40	1.20	66.5°	1.50	1.00	70.0°	0.95
32.00			59.5°	0.85	0.70	64.0°	1.35	0.85	68.0°	0.85
34.00						61.5°	0.95	0.60	65.5°	0.75
36.00									63.5°	0.64
38.00									61.0°	0.55
MINIMUM BOOM ANGLE	56.0° (32.00M)	56.5° (34.30M)	57.0° (33.60M)	58.0° (36.80M)	59.0° (35.50M)	59.0° (39.60M)				

AT950265/21184/20

L.M.I. OPERATING CODE REFER TO L.M.I. MANUAL FOR INSTRUCTIONS

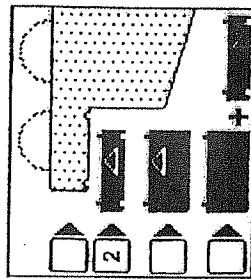

2 WITH 2.00 TONNES COUNTERWEIGHT

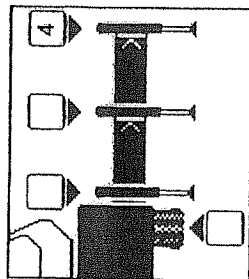

4 OUTRIGGERS FULLY EXTENDED

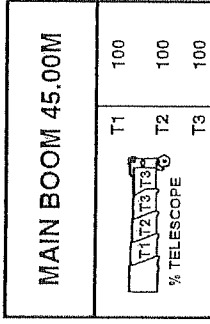

MAIN BOOM 45.00M

T1 100
T2 100
T3 100
1/4 TELESCOPE

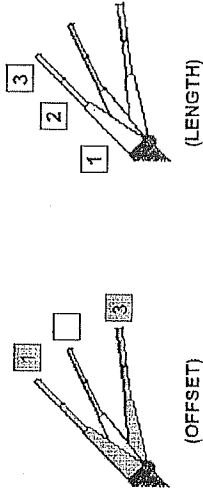

(OFFSET)

(LENGTH)

EXT OFFSET	EXT LENGTH	PAT SELECTION	
		EXT OFFSET	EXT LENGTH
2°	9.68M	1	1
30°		3	
2°	13.34M	1	2
30°		3	
2°	17.00M	1	3
30°		3	

1. ALL CAPACITIES ABOVE THE BOLD LINE ARE BASED ON STRUCTURAL STRENGTH OF THE EXTENSION AND BELOW THE LINE DO NOT EXCEED 85% OF THE TIPPING LOAD AS DETERMINED BY TEST IN ACCORDANCE WITH SAE J765.

2. RATED LOAD IS BASED ON LOADED MAIN BOOM ANGLE WITH REFERENCE TO HORIZONTAL, REGARDLESS OF MAIN BOOM LENGTH QUOTED. (REF. RADIUS IN METRES IS FOR BOOM LENGTH SHOWN ABOVE ONLY).

WARNING:-

OPERATION OF THIS MACHINE WITH HEAVIER LOADS THAN THE CAPACITIES LISTED IS STRICTLY PROHIBITED. MACHINE TIPPING WITH THE EXTENSION OCCURS RAPIDLY AND WITHOUT WARNING. REMOVE ALL RIGGING ACCESSORIES FROM MAIN BOOM WHEN USING THE EXTENSION.

3. 9.68M - 17.00M TELE OFFSETTABLE BOOM EXTENSION WARNING:- WITH THE EXTENSION IN THE WORKING POSITION, THE MAIN BOOM MUST BE FULLY RETRACTED FOR BOOM ANGLES LESS THAN THOSE SHOWN ON THE LOAD CHART FOR THAT PARTICULAR EXTENSION LENGTH AND OFFSET. THIS WARNING ALSO APPLIES FOR BOOM EXTENSION ERECTION PURPOSES.

IDENTIFICATION
AT990E

SERIAL NUMBER
84057

**PART " B " COUNTERWEIGHT - 2.00 TONNES
OUTRIGGERS FULLY EXTENDED AT 7.20M**

LIFTING CAPACITIES IN TONNES - 360°

L.M.I. CODE	# 0221	# 0223				# 0231				# 0233				# 0241				# 0243
		9.68M LENGTH				13.34M LENGTH				17.00M LENGTH				17.00M LENGTH				
		0° OFFSET		30° OFFSET		0° OFFSET		30° OFFSET		0° OFFSET		30° OFFSET		0° OFFSET		30° OFFSET		
L°	LOAD	L°	LOAD	L°	LOAD	L°	LOAD	L°	LOAD	L°	LOAD	L°	LOAD	L°	LOAD			
8.00	MAX	6.80																
9.00	81.0°	6.50																
10.00	80.0°	6.30			MAX	5.10												
12.00	78.0°	5.00	MAX	3.40	79.5°	4.75												
14.00	76.0°	5.70	79.5°	3.20	77.5°	4.40	MAX	2.05	79.0°	3.25								
16.00	74.0°	5.20	77.0°	3.05	75.5°	4.00	80.0°	1.95	77.0°	3.00								
18.00	71.5°	4.80	74.5°	2.90	73.5°	3.70	78.0°	1.90	75.0°	2.80	81.0°	1.25						
20.00	69.0°	4.40	72.5°	2.80	71.0°	3.40	76.0°	1.80	73.0°	2.55	79.0°	1.15						
22.00	66.5°	3.40	70.0°	2.65	69.0°	3.10	73.5°	1.70	71.0°	2.30	77.0°	1.10						
24.00	64.0°	2.55	67.5°	2.55	66.5°	2.85	71.0°	1.64	69.0°	2.05	75.0°	1.07						
26.00	61.5°	1.85	65.0°	2.45	64.5°	2.25	69.0°	1.57	66.5°	1.85	72.5°	1.04						
28.00	59.0°	1.20	62.0°	1.85	62.0°	1.65	66.5°	1.50	64.5°	1.70	70.5°	1.00						
30.00	56.0°	0.60	59.5°	1.25	59.5°	1.10	64.0°	1.45	62.0°	1.50	68.0°	0.97						
32.00			56.5°	0.70	57.0°	0.60	61.5°	1.35	60.0°	0.95	66.0°	0.95						
34.00							58.5°	0.85			63.5°	0.90						
36.00											61.0°	0.85						
MINIMUM BOOM ANGLE	54.0° (31.30M)	54.0° (33.60M)	55.0° (39.00M)	55.5° (36.30M)	56.0° (35.10M)	56.5° (39.200M)												

L.M.I. OPERATING CODE REFER TO L.M.I. MANUAL FOR INSTRUCTIONS

AT9906/99/2/1/4/22

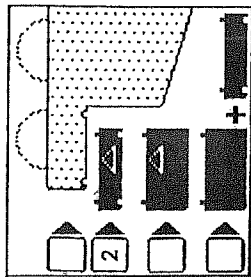

2 WITH 2.00 TONNES COUNTERWEIGHT

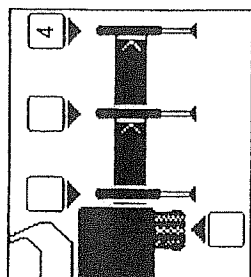

4 OUTRIGGERS FULLY EXTENDED

MAIN BOOM 42.00M			
T1	100		
T2	100		
T3	82		

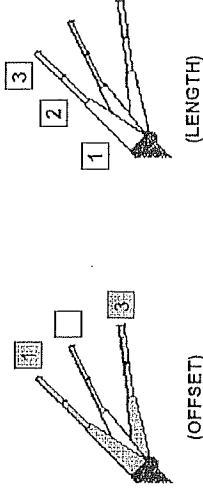
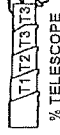

EXT OFFSET	EXT LENGTH	PAT SELECTION	
		EXT OFFSET	EXT LENGTH
2°	9.68M	1	1
30°		3	
2°	13.34M	1	2
30°		3	
2°	17.00M	1	3
30°		3	

1. ALL CAPACITIES ABOVE THE BOLD LINE ARE BASED ON STRUCTURAL STRENGTH OF THE EXTENSION AND BELOW THE LINE DO NOT EXCEED 85% OF THE TIPPING LOAD AS DETERMINED BY TEST IN ACCORDANCE WITH SAE J765.
 2. RATED LOAD IS BASED ON LOADED MAIN BOOM ANGLE WITH REFERENCE TO HORIZONTAL, REGARDLESS OF MAIN BOOM LENGTH QUOTED. (REF. RADIUS IN METRES IS FOR BOOM LENGTH SHOWN ABOVE ONLY).

WARNING:-

OPERATION OF THIS MACHINE WITH HEAVIER LOADS THAN THE CAPACITIES LISTED IS STRICTLY PROHIBITED. MACHINE TIPPING WITH THE EXTENSION OCCURS RAPIDLY AND WITHOUT WARNING. REMOVE ALL REEVING / RIGGING ACCESSORIES FROM MAIN BOOM WHEN USING THE EXTENSION.
 3. 9.68M - 17.00M TELE OFFSET BOOM EXTENSION WARNING:- WITH THE EXTENSION IN THE WORKING POSITION, THE MAIN BOOM MUST BE FULLY RETRACTED FOR BOOM ANGLES LESS THAN THOSE SHOWN ON THE LOAD CHART FOR THAT PARTICULAR EXTENSION LENGTH AND OFFSET. THIS WARNING ALSO APPLIES FOR BOOM EXTENSION ERECTION PURPOSES.

IDENTIFICATION SERIAL NUMBER
AT9906 84057

WEIGHT REDUCTION FOR LOAD HANDLING DEVICES

WEIGHT REDUCTION FOR NON FITMENT OF AUX HOIST ROPE H015 AUX. HOIST 0.215 TONNES H030 AUX. HOIST 0 TONNES

AUXILIARY BOOM NOSE	- 0.10 TONNES
---------------------	---------------

HOOKBLOCKS	
6 SHEAVE HEADACHE BALL	- 0.73 TONNES - 0.15 TONNES

9.68M - 17.00M EXTENSION	
STOWED	BUT NOT IN USE - 0.34 TONNES
ERECTED (9.68M)	BUT NOT IN USE - 2.63 TONNES
ERECTED (13.34M)	BUT NOT IN USE - 3.10 TONNES
ERECTED (17.00M)	BUT NOT IN USE - 3.59 TONNES

NOTE: ALL LOAD HANDLING DEVICES AND BOOM ATTACHMENTS ARE CONSIDERED PART OF THE LOAD AND SUITABLE ALLOWANCES MUST BE MADE FOR THEIR COMBINED WEIGHTS.
WEIGHTS ARE FOR GROVE FURNISHED EQUIPMENT.

LINE PULL AND REEVING INFORMATION

HOIST	CABLE SPEC.	PERMISSIBLE LINE PULLS
MAIN HC30F-26G	19MM X 240M DYFORM 18 BREAKING LOAD 32.20 TONNES	5.42 TONNES
AUX HC30F-26G	19MM X 240M DYFORM 18 BREAKING LOAD 32.20 TONNES	5.42 TONNES

HOOKBLOCKS

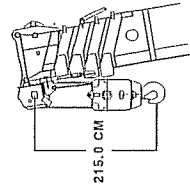

6 SHEAVE

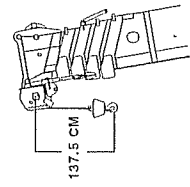

HEADACHE BALL

RANGE DIAGRAM

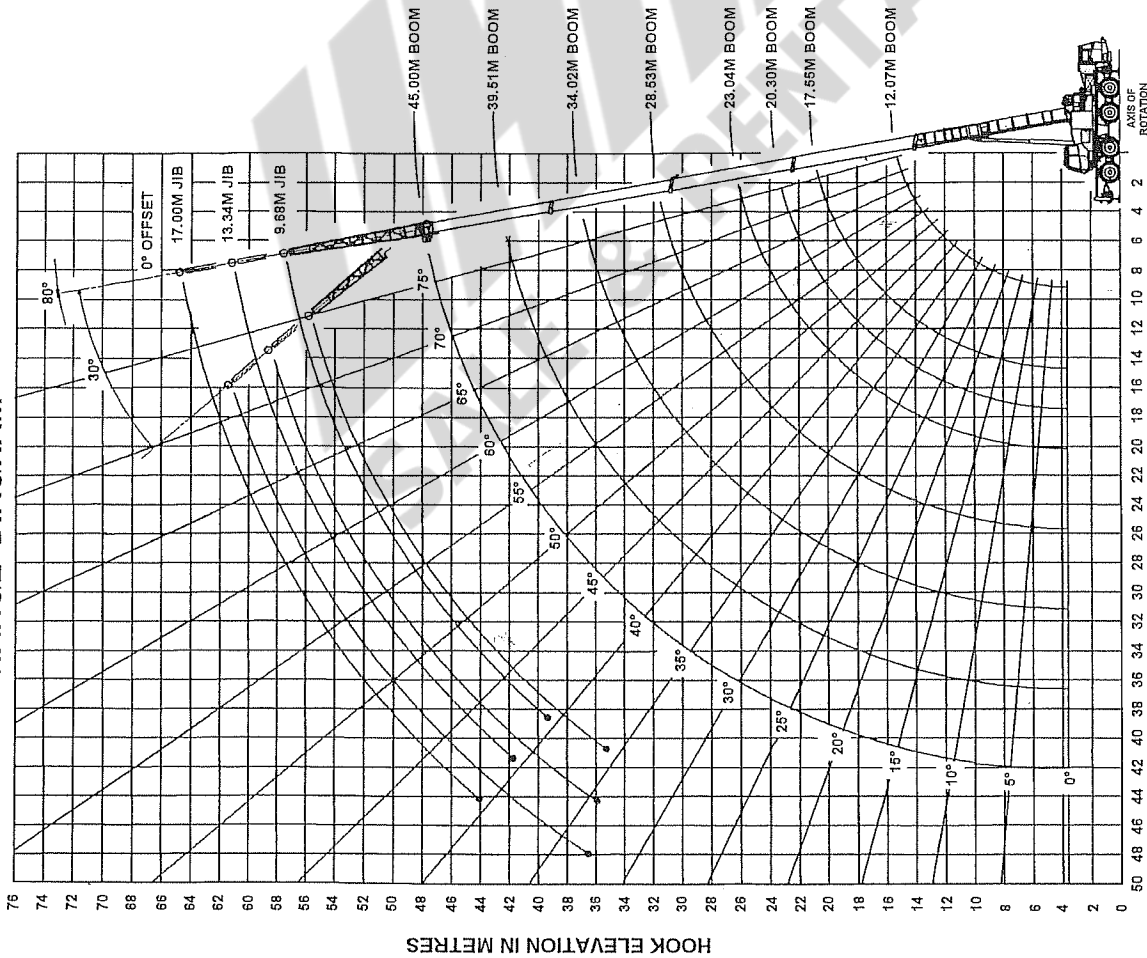

OPERATING RADIUS FROM AXIS OF ROTATION

IDENTIFICATION SERIAL NUMBER
AT990E 84057

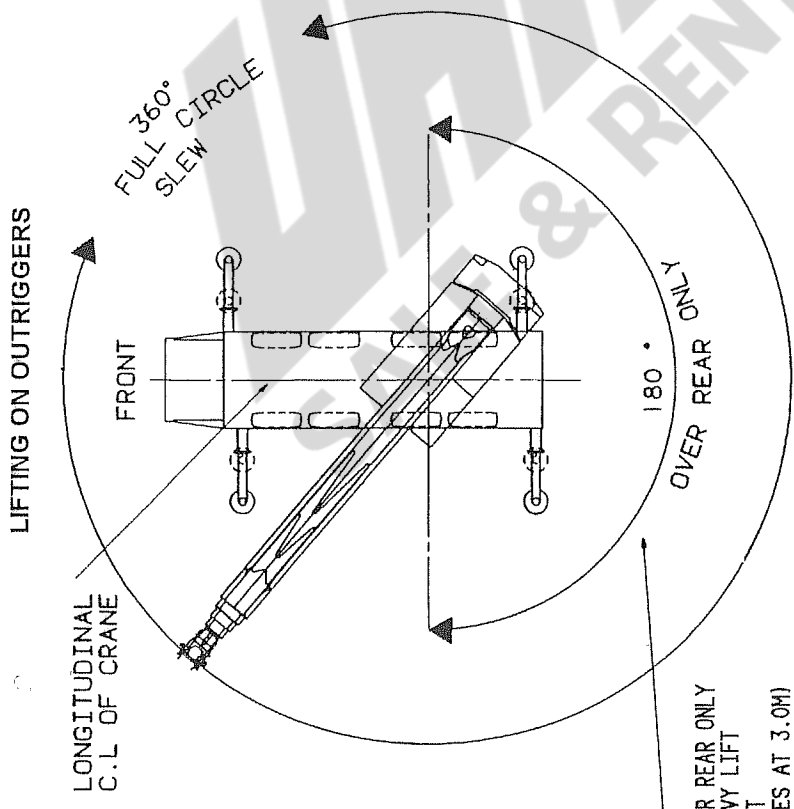
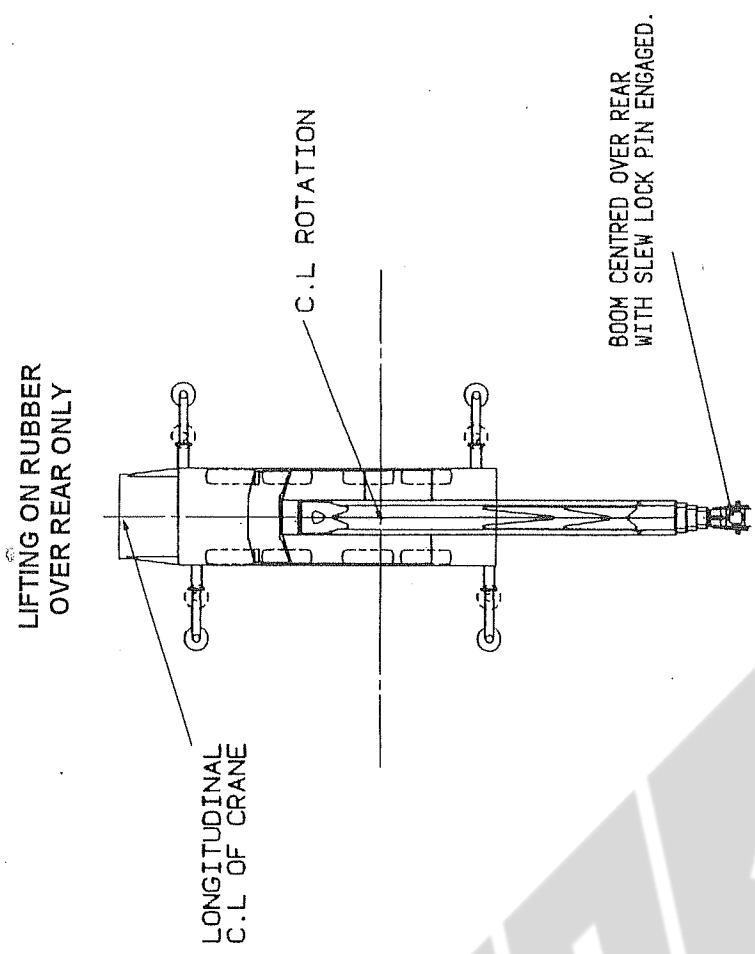

NOTE:
180° OVER REAR ONLY
WITH HEAVY LIFT
EQUIPMENT
(80 TONNES AT 3.0M)

SERIAL NUMBER
84057

IDENTIFICATION
AT990E