



# GR-150XL

15 Ton Capacity (13.6 Metric Tons)

## HYDRAULIC ROUGH TERRAIN CRANE

### DIMENSIONS

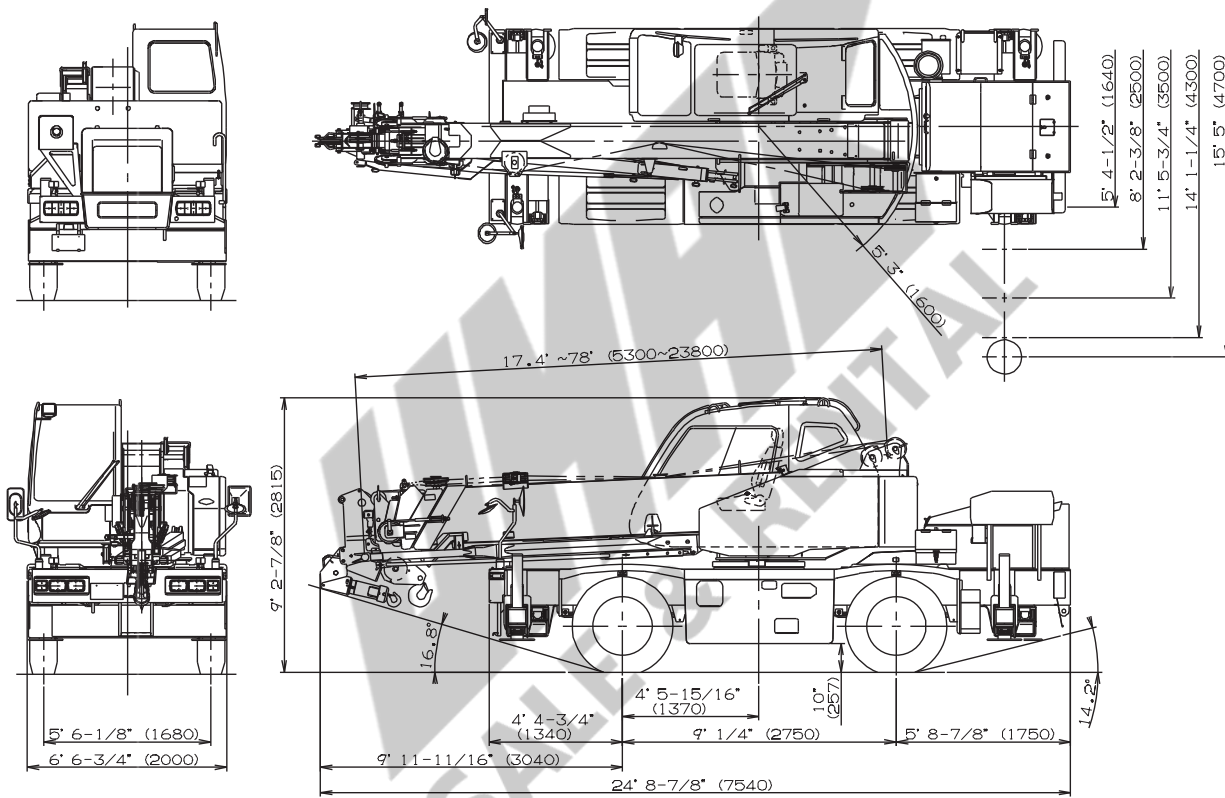

### GENERAL DIMENSIONS (275/80R22.5 Tires)

	Feet	Meters
Turning radius		
4 wheel steer	12' 5-5/8"	3.8
2 wheel steer	21' 3-7/8"	6.5

Specifications are subject to change without notice.  
Specifications effective with S/N FD1787 and up.

# CRANE SPECIFICATIONS

## BOOM

Six section full power synchronized telescoping boom, 17.4'~78' (5.3m~23.8m), of box construction with 4 sheaves, 9-5/16" (0.236m) root diameter, at boom head.

The synchronization system consists of two double acting telescope cylinders, extension cables and retraction cables.

Hydraulic cylinder fitted with holding valve. Two easily removable wire rope guards, rope dead end provided on both sides of boom head. Boom telescope sections are supported by wear pads both vertically and horizontally.

Extension speed 60.6' (18.5m) in 52 seconds.

**BOOM ELEVATION** - By a double acting hydraulic cylinder with holding valve. Elevation -3°~82°, combination controls for hand or foot operation. Boom angle indicator.

Automatic speed reduction and soft stop function.

Elevation speed -3°~82° in 29 seconds.

**JIB(OPTIONAL)** - Two stage extension type with 5°, 25°, 45° or 60° offset(tilt type). Single sheave, 8"(0.203m) root diameter, at jib head. Box type top section telescopes from box type base section which stores under base boom section. Jib length is 11.8' (3.6m) or 18' (5.5m).

## AUXILIARY LIFTING SHEAVE (SINGLE TOP) (OPTIONAL)

Single sheave, 8"(0.203m) root diameter. Mounted to main boom head for single line work.

**ANTI-TWO BLOCK** - Pendant type over-winding cut out device with audio-visual (FAILURE lamp/BUZZER) warning system.

## SWING

Hydraulic axial piston motor driven through planetary swing speed reducer. Continuous 360° full circle swing on ball bearing turntable at 2.4rpm. Equipped with manually locked/released swing brake. A 360° positive swing lock for pick and carry and travel modes.

## HOIST

**MAIN HOIST** - Grooved drum driven by hydraulic axial piston motor through winch speed reducer. Power load lowering and raising. Equipped with automatic brake (neutral brake) and counterbalance valve. Controlled independently of auxiliary hoist. Equipped with cable follower and drum rotation indicator.

**DRUM** - Grooved 10-7/16"(0.265m) root diameter x 9-7/16"(0.239m) wide. Wire rope: 433' of 7/16"diameter rope (132m of 11.2mm). Drum capacity: 486.8' (148.4m) 7 layers. Maximum line pull (available): 6,700lbs. (3,050kg). Maximum line speed: 410FPM (125m/min) at the 5th layer.

**AUXILIARY HOIST** - Grooved drum driven by hydraulic axial piston motor through winch speed reducer. Power load lowering and raising. Equipped with automatic brake (neutral brake) and counterbalance valve. Controlled independently of main hoist. Equipped with cable follower and drum rotation indicator.

**DRUM** - Grooved 10-7/16"(0.265m) root diameter x 9-7/16"(0.239m) wide. Wire rope: 217' of 7/16"diameter rope (66m of 11.2mm). Drum capacity: 486.8' (148.4m) 7 layers. Maximum line pull (available): 6,700lbs. (3,050kg). Maximum line speed: 361FPM (110m/min) at the 3rd layer.

**WIRE ROPE** - Warrington seal wire, extra improved plow steel, preformed, independent wire rope core, right regular lay. 7/16"(11.2mm) 6X37 class

Maximum Permissible Line Pull (Main) : 5,450lbs (2,470kg)

Maximum Permissible Line Pull (Auxiliary) : 5,730lbs (2,600kg)

## HOOK BLOCKS

15.0 ton (13.6 metric ton) - Weighted hook with swivel and safety latch, for 7/16"(11.2mm) wire rope.

2.0 ton (1.8 metric ton) - Weighted hook with swivel and safety latch, for 7/16"(11.2mm) wire rope.

## HYDRAULIC SYSTEM

**PUMPS** - Two variable piston pumps for crane functions.

Tandem gear pump for steering, swing and accumulator.

Powered by carrier engine. Pump disconnect for crane is engaged/ disengaged by rotary switch from operator's cab.

**CONTROL VALVES** - Multiple valves actuated by pilot pressure with integral pressure relief valves.

**RESERVOIR** - 45 gallon (172 lit.) capacity. External sight level gauge.

**FILTRATION** -  $\beta_{10} \geq 10$  (26 micron) return filter, full flow with bypass protection, located inside of hydraulic reservoir. Accessible for easy replacement.

**OIL COOLER** - Air cooled fan type.

## CAB AND CONTROLS

Both crane and drive operations can be performed from one cab mounted on rotating superstructure.

Right side, 1 man type, steel construction with sliding door access and tinted safety glass windows opening at side. Door window is powered control. Windshield glass window and roof glass window are shatter-resistant. Tilt-telescoping steering wheel. Adjustable control lever for swing, boom hoist, boom telescoping, auxiliary hoist and main hoist. Control lever can change neutral positions and tilt for easy access into cab. 3 way adjustable operator's seat with high back, headrest and armrest. Engine throttle knob. Foot operated controls : boom hoist, boom telescoping, service brake and engine throttle. Hot water cab heater and air conditioning.

Dash-mounted engine start/stop, monitor lamps, cigarette lighter, drive selector switch, parking brake switch, steering mode select switch, power window switch, pump engaged / disengaged switch, swing brake switch and outrigger controls.

Instruments - Torque converter oil temperature, engine water temperature, air pressure, fuel, speedometer, tachometer and hour meter. Hydraulic oil pressure is monitored and displayed on the AML-C display panel.

Tadano electronic LOAD MOMENT INDICATOR system (AML-C) including

- Control lever lockout function with audible and visual pre-warning
- Boom position indicator
- Outrigger status indicator
- Boom angle / boom length / jib offset angle / load radius / rated lifting capacities / actual loads read out
- Ratio of actual load moment to rated load moment indication
- Automatic Speed Reduction and Soft Stop function on boom elevation and swing
- Working condition register switch
- Load radius / boom angle / tip height / swing range preset function
- External warning lamp

TADANO AML-C monitors outrigger extended length and automatically programs the corresponding "RATED LIFTING CAPACITIES" table.

Operator's left hand console includes transmission gear selector and sight level bubble. Upper console includes roof washer and wiper switch, emergency outrigger set up key switch, jib equipped / removed select switch and air conditioning control switch. Lower console includes working light switch and boom emergency telescoping switch (2nd-3rd and 4th-top).

NOTE: Each crane motion speed is based on unladen conditions.

## CARRIER SPECIFICATIONS

**TYPE** - Rear engine, right hand steering, driving axle 2-way selected type by manual switch, 4x2 front drive, 4x4 front and rear drive.

**FRAME** - High tensile steel, all welded mono-box construction

**TRANSMISSION** - Electronically controlled full automatic transmission. Torque converter driving full powershift with driving axle selector. 6 forward and 2 reverse speeds, constant mesh.

- 3 speeds - high range - 2 wheel drive; 4 wheel drive
- 3 speeds - low range - 4 wheel drive

**TRAVEL SPEED** - 30.4 mph (49 km/h)

**AXLE** - Front: Full floating type, steering and driving axle with Rear: Full floating type, steering and driving axle.

**STEERING** - Hydraulic power steering controlled by steering wheel. Four steering modes available: 2 wheel front, 2 wheel rear, 4 wheel coordinated and 4 wheel crab .

**SUSPENSION** - Semi-elliptic leaf springs with hydraulic lockout device.

**BRAKE SYSTEMS** - Service: Air over hydraulic disc brakes on all 4 wheels. Parking/Emergency: Spring applied-air released brake acting on input shaft of front axle. Auxiliary: Electro pneumatic operated exhaust brake.

**TIRES** - 275/80R22.5

**OUTRIGGERS** - Four hydraulic, beam and jack outriggers. Vertical jack cylinders equipped with integral holding valve. Each outrigger beam and jack is controlled independently from cab. Beams extend to 15' 5" (4.7 m) center-line and retract to within 5' 4-1/2" (1.64 m) overall width with floats. Outrigger jack floats are attached thus eliminating the need of manually attaching and detaching them. Controls and sight bubble located in superstructure cab. Four outrigger extension lengths are provided with corresponding "RATED LIFTING CAPACITIES" for crane duty in confined areas. Both symmetrical and Non-symmetrical outrigger extension (deployment) is permitted

Min. Extension	5' 4-1/2" center to center
Mid. Extension	8' 2-3/8" center to center
Mid. Extension	11' 5-3/4" center to center
Mid. Extension	14' 1-1/4" center to center
Max. Extension	15' 5" center to center

Float size(Diameter) 1' 1-3/4" (0.35m)

### ENGINE

Model	Mitsubishi 4M50-TLA3B
Type	Direct injection diesel
No. of cylinders	4
Combustion	4 cycle, turbo charged and after cooled
Bore x Stroke, in.(mm)	4.488 x 4.724 (114 x 120)
Displacement, cu. in (liters)	299 (4.9)
Air inlet heater	24 volt preheat
Air cleaner	Dry type, replaceable element
Oil filter	Full flow with replaceable element
Fuel filter	Full flow with replaceable element
Fuel tank, gal.(liters)	50 (189), right side of carrier
Cooling	Liquid pressurized, recirculating by-pass

Radiator	Fin and tube core, thermostat controlled
Fan, in.(mm)	Suction type, 10-blade, 18 (457) dia.
Starting	24 volt
Charging	24 volt system, negative ground
Battery	2-80 amp. Hour
Compressor, air, CFM(l /min)	21.6 CFM (612) at 2,700rpm
Horsepower (kW)	Gross 172 (129) at 2,700rpm
Torque, Max. ft-lb (kgm)	390 (54) at 1,600rpm
Capacity, gal.(liters)	
Cooling water	2.9 (11)
Lubrication	2.1 ~ 2.9 (8 ~ 11)
Fuel	50 (189)

# STANDARD EQUIPMENT

- Six section full power partially synchronized boom  
17.4' ~ 78' (5.3 m~23.8 m)
- Main hoist with grooved drum and 433' of 7/16" cable.
- Drum rotation indicator (visual type) main
- Anti-Two block device (overwind cutout)
- Tadano electronic load moment indicator system (AML-C)
- Outrigger extension length detector
- Electronic crane monitoring system
- 360° Positive Swing Lock
- Self centering finger control levers with pilot control
- Control pedals for boom elevating and boom telescoping
- 3 way adjustable cloth suspension seat with armrests, high back and seat belt
- Tilt-telescoping steering wheel
- Tinted safety glass and sun visor
- Front windshield wiper and washer
- Roof window wiper and washer
- Power window (cab door)
- Rear view mirrors (right and left side)
- Cigarette lighter
- Electric fan in cab
- Cab floor mat
- Pump disconnect in operator's cab
- Hydraulic oil cooler
- Independently controlled outriggers
- Four outrigger extension positions
- Self-storing outrigger pads
- Mitsubishi 4M50-TL turbo charged after cooled engine(172HP) with exhaust brake
- Electronic controlled automatic transmission driven by torque converter
- 4 X 4 X 4 drive/steer
- Hydraulic lockout suspension system
- 275/80R22.5 tires
- Disc brakes
- Fenders
- Air dryer
- Water separator with filter
- Engine over-run alarm
- Back-up alarm
- Low oil pressure/high water temp. warning device(visual)
- Rear steer centering light
- Air cleaner dust indicator
- Full instrumentation package
- Complete highway light package
- Work lights
- Tool storage compartment
- Tire inflation kit
- 24 volt electric system
- 15 ton (13.6 metric ton) hook with swivel
- 2.0 ton (1.8 metric ton) hook with swivel
- Towing hooks-Front and rear
- Hot water cab heater and air conditioner

# OPTIONAL EQUIPMENT

- 11.8' or 18' (3.6 m or 5.5 m) box jib (tilt type) with 5°, 25°,45° or 60° pinned offsets and self storing pins.
- Auxiliary lifting sheave (single top) stowable
- Auxiliary hoist with grooved drum / 217' of 7/16" cable and drum rotation indicator (visual type).

# HOISTING PERFORMANCE

Layer	Main or auxiliary hoist - 10-7/8" (0.28m) drum, 7/16" (11.2mm) wire rope							
	Line speeds <sup>2</sup>		Line pulls				Drum grooved lagging	
			Available <sup>1</sup>		Permissible <sup>3</sup>		Total wire rope	
	F.P.M	m/min	Lbs.	kgf	Lbs.	kgf	Feet	Meters
1st	308	94	6,700	3,050	6,200	2,830	57.0	17.4
2nd	330	101	6,200	2,810	5,700	2,610	118.3	36.0
3rd	361	108	5,700	2,610	5,300	2,420	183.6	56.0
4th	375	114	5,400	2,430	5,000	2,260	253.2	77.2
5th	410	121	5,000	2,280	4,700	2,110	326.9	99.6
6th	420	128	4,700	2,140	4,400	1,990	404.8	123.4
7th	443	135	4,500	2,020	4,100	1,870	486.8	148.4

<sup>1</sup> Developed by machinery with each layer of wire rope, but not based on rope strength or other limitation in machinery or equipment.

<sup>2</sup> Line speeds based only on hook block, not loaded.

<sup>3</sup> Permissible line pull may be affected by wire rope strength.

## DRUM DIMENSIONS

	Inch	mm
Root diameter	10-7/16"	265
Length	Main	9-7/16"
	Auxiliary	9-7/16"
Flange diameter	1' 5-11/16"	450

# GR-150XL WORKING RANGE CHART

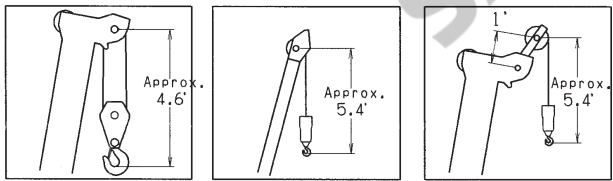
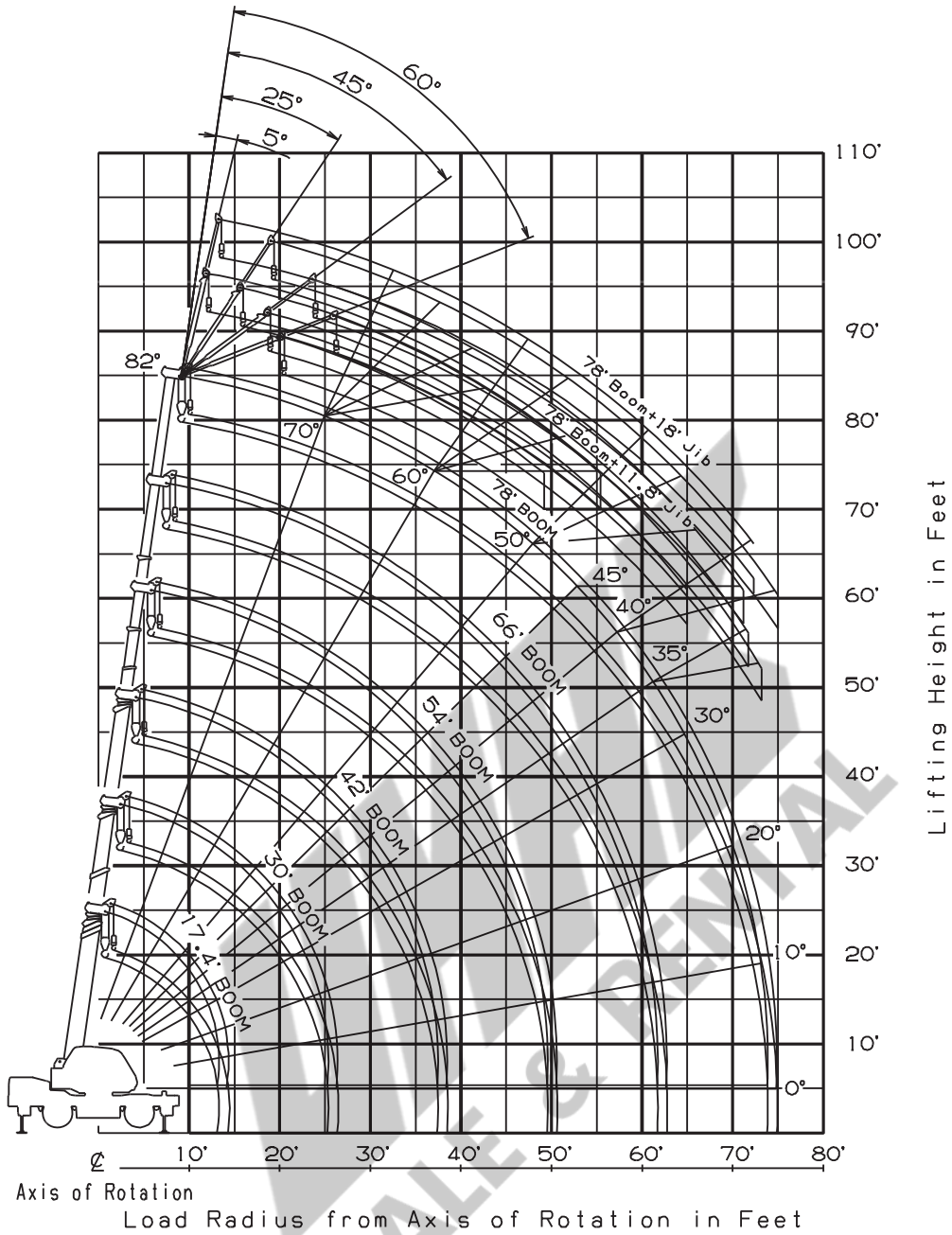

NOTE: Boom and jib geometry shown are for unloaded condition and machine standing level on firm supporting surface. Boom deflection and subsequent radius and boom angle change must be accounted for when applying load to hook.

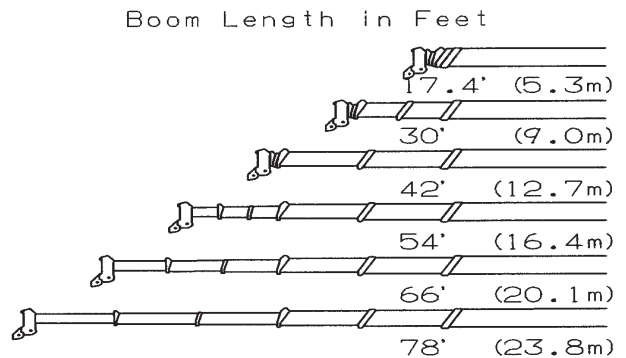

# GR-150XL RATED LIFTING CAPACITIES (IN POUNDS)

ON OUTRIGGERS FULLY EXTENDED 15' 5" (4.7m) SPREAD												
360° ROTATION												
A \ B	17.4'		30'		42'		54'		66'		78'	
	C	(5.3m)	C	(9.0m)	C	(12.7m)	C	(16.4m)	C	(20.1m)	C	(23.8m)
4	70.4	30,000	78.9	13,200								
5	66.7	30,000	77.3	13,200	80.9	13,200						
6	62.8	28,800	75.1	13,200	79.5	13,200						
8	54.2	23,800	70.8	13,200	76.7	13,200	79.9	11,000				
10	44.1	17,800	66.7	13,200	73.8	13,200	78.0	11,000	80.4	9,900		
12	30.8	14,800	62.4	13,200	71.0	13,200	75.8	11,000	78.7	9,900	80.5	6,600
15			55.4	11,500	66.6	11,100	72.4	10,850	76.0	8,950	78.5	6,600
20			42.1	8,300	58.5	8,000	66.6	7,750	71.5	7,050	74.8	6,050
25			19.5	6,200	49.8	5,850	60.6	5,700	66.8	5,500	70.9	4,950
30					39.4	4,050	54.3	4,400	61.8	4,400	66.9	4,100
35					25.2	2,950	47.1	3,350	56.5	3,550	62.6	3,350
40							38.9	2,650	51.0	3,150	58.3	2,800
45							28.3	1,950	44.8	2,400	53.7	2,350
50									37.9	1,850	48.6	2,000
55									29.3	1,400	43.2	1,550
60									16.2	1,050	37.2	1,250
65											29.9	1,000
70											20.2	770
D	0°											

LIFTING CAPACITIES AT ZERO DEGREE BOOM ANGLE ON OUTRIGGERS												
FULLY EXTENDED 15' 5" (4.7m) SPREAD 360° ROTATION												
C \ A	17.4'		30'		42'		54'		66'		78'	
	B	(5.3m)	B	(9.0m)	B	(12.7m)	B	(16.4m)	B	(20.1m)	B	(23.8m)
0°	13.1	13,500	25.3	5,900	37.4	2,600	49.5	1,600	61.7	1,000	73.8	600

ON OUTRIGGERS MID EXTENDED 14' 1-1/4" (4.3m) SPREAD												
360° ROTATION												
A \ B	17.4'		30'		42'		54'		66'		78'	
	C	(5.3m)	C	(9.0m)	C	(12.7m)	C	(16.4m)	C	(20.1m)	C	(23.8m)
4	70.4	30,000	78.9	13,200								
5	66.7	30,000	77.3	13,200	80.9	13,200						
6	62.8	28,800	75.1	13,200	79.5	13,200						
8	54.2	23,800	70.8	13,200	76.7	13,200	79.9	11,000				
10	44.1	17,800	66.7	13,200	73.8	13,200	78.0	11,000	80.4	9,900		
12	30.8	14,800	62.4	13,200	71.0	13,200	75.8	11,000	78.7	9,900	80.5	6,600
15			55.3	11,300	66.6	11,100	72.4	10,850	76.0	8,950	78.5	6,600
20			42.1	8,050	58.5	7,450	66.6	7,750	71.5	7,050	74.8	6,050
25			19.5	5,500	49.8	5,300	60.6	5,400	66.7	5,100	70.9	4,950
30					39.4	3,500	54.2	4,050	61.7	4,100	66.8	3,900
35					25.2	2,500	47.0	2,850	56.5	3,200	62.6	3,200
40							38.7	2,100	50.9	2,300	58.3	2,550
45							28.1	1,450	44.6	1,750	53.6	1,950
50									37.7	1,250	48.5	1,500
55									29.3	900	43.1	1,150
60									16.2	600	37.0	900
65											29.8	600
D	0°											23

LIFTING CAPACITIES AT ZERO DEGREE BOOM ANGLE ON OUTRIGGERS												
MID EXTENDED 14' 1-1/4" (4.3m) SPREAD 360° ROTATION												
C \ A	17.4'		30'		42'		54'		66'			
	B	(5.3m)	B	(9.0m)	B	(12.7m)	B	(16.4m)	B	(20.1m)		
0°	13.1	13,200	25.3	5,200	37.4	2,000	49.5	1,100	61.7	500		

- A : Boom length in feet
- B : Load radius in feet
- C : Loaded boom angle (deg.)
- D : Minimum boom angle (deg.) for indicated length (no load)

# GR-150XL RATED LIFTING CAPACITIES (IN POUNDS)

ON OUTRIGGERS MID EXTENDED 11' 5-3/4" (3.5m) SPREAD												
360° ROTATION												
A \ B	17.4'		30'		42'		54'		66'		78'	
	C	(5.3m)	C	(9.0m)	C	(12.7m)	C	(16.4m)	C	(20.1m)	C	(23.8m)
4	70.4	30,000	78.9	13,200								
5	66.7	30,000	77.3	13,200	80.9	13,200						
6	62.8	28,800	75.1	13,200	79.5	13,200						
8	54.2	23,800	70.8	13,200	76.7	13,200	79.9	11,000				
10	44.1	17,800	66.7	13,200	73.8	13,200	78.0	11,000	80.4	9,900		
12	30.8	14,800	62.4	13,200	71.0	13,200	75.8	11,000	78.7	9,900	80.5	6,600
15			55.2	10,150	66.6	10,000	72.4	9,450	76.0	8,950	78.5	6,600
20			42.0	5,800	58.5	5,550	66.5	6,300	71.4	6,550	74.8	5,950
25			19.5	3,600	49.7	3,400	60.4	4,050	66.6	4,400	70.8	4,500
30					39.3	2,100	53.9	2,650	61.4	3,000	66.7	3,100
35					24.9	1,250	46.5	1,800	56.3	2,050	62.4	2,250
40							38.3	1,150	50.6	1,350	58.0	1,550
45							27.6	700	44.5	950	53.2	1,050
50									37.4	650	48.2	700
55											42.9	450
D	0°						26°			39°		

LIFTING CAPACITIES AT ZERO DEGREE BOOM ANGLE ON OUTRIGGERS												
MID EXTENDED 11' 5-3/4" (3.5m) SPREAD 360° ROTATION												
A \ C	17.4'		30'		42'		54'					
	B	(5.3m)	B	(9.0m)	B	(12.7m)	B	(16.4m)				
0°	13.1	13,200	25.3	3,300	37.4	1,000	49.5	400				

ON OUTRIGGERS MID EXTENDED 8' 2-3/8" (2.5m) SPREAD												
360° ROTATION												
A \ B	17.4'		30'		42'		54'		66'		78'	
	C	(5.3m)	C	(9.0m)	C	(12.7m)	C	(16.4m)	C	(20.1m)	C	(23.8m)
4	70.4	30,000	78.9	13,200								
5	66.7	30,000	77.3	13,200	80.9	13,200						
6	62.8	28,800	75.1	13,200	79.5	13,200						
8	54.1	18,700	70.8	13,200	76.7	13,200	79.9	11,000				
10	43.6	12,200	66.7	11,800	73.7	11,800	78.0	11,000	80.4	9,900		
12	30.5	8,800	62.3	8,600	70.8	8,550	75.6	9,250	78.7	9,900	80.5	6,600
15			55.2	5,450	66.3	5,350	72.2	6,000	75.8	6,300	78.5	6,600
20			42.0	2,850	58.3	2,750	66.4	3,300	71.1	3,600	74.5	3,850
25			19.5	1,500	49.6	1,350	60.3	1,900	66.3	2,200	70.4	2,350
30					39.0	500	53.8	1,000	61.3	1,350	66.3	1,450
35							46.5	500	56.0	750	62.0	850
40											57.7	450
D	0°				30°		41°		49°		55°	

LIFTING CAPACITIES AT ZERO DEGREE BOOM ANGLE ON OUTRIGGERS												
MID EXTENDED 8' 2-3/8" (2.5m) SPREAD 360° ROTATION												
A \ C	17.4'		30'									
	B	(5.3m)	B	(9.0m)								
0°	13.1	7,400	25.3	1,300								

- A : Boom length in feet
- B : Load radius in feet
- C : Loaded boom angle (deg.)
- D : Minimum boom angle (deg.) for indicated length (no load)

# GR-150XL RATED LIFTING CAPACITIES (IN POUNDS)

ON OUTRIGGERS MIN EXTENDED 5' 4-1/2" (1.64m) SPREAD 360° ROTATION												
A \ B	17.4'		30'		42'		54'		66'		78'	
	C	(5.3m)	C	(9.0m)	C	(12.7m)	C	(16.4m)	C	(20.1m)	C	(23.8m)
4	70.3	17,500	78.9	13,200								
5	66.6	15,300	77.4	12,800	80.9	12,500						
6	62.5	13,250	75.0	12,300	79.5	12,500						
8	54.1	8,650	70.8	8,800	76.6	8,300	79.9	7,500				
10	44.0	5,800	66.6	6,100	73.8	5,600	77.6	5,600	80.1	5,600		
12	30.1	4,250	62.2	4,100	70.9	4,050	75.3	4,200	78.3	4,300	80.4	4,350
15			55.2	2,450	66.4	2,300	72.0	2,700	75.5	3,000	77.9	3,100
20			41.8	900	58.5	750	66.2	1,250	71.0	1,550	74.1	1,800
25											70.2	950
D	0°		26°		52°		58°		63°		67°	

LIFTING CAPACITIES AT ZERO DEGREE BOOM ANGLE ON OUTRIGGERS MIN EXTENDED 5' 4-1/2" (1.64m) SPREAD 360° ROTATION		
A \ C	B	(5.3m)
0°	13.1	3,500

- A : Boom length in feet
- B : Load radius in feet
- C : Loaded boom angle (deg.)
- D : Minimum boom angle (deg.)  
for indicated length (no load)

**NOTE:**

Standard number of parts of line for each boom length is as shown below.  
Load per line should not surpass 1,800 kg for main winch and auxiliary winch.

Boom Length in Feet (meters)	17.4' (5.3m)	17.4' to 78' (5.3m to 23.8m)	Single top Jib
Number of parts of line	8	4	1

The lifting capacity data stored in the AUTOMATIC LIMITER(AML-C) is based on the standard number of parts of line listed in the chart.



# GR-150XL RATED LIFTING CAPACITIES (IN POUNDS)

ON OUTRIGGERS FULLY EXTENDED 15' 5" (4.7m) SPREAD 360° ROTATION									
C	78' (23.8m) Boom + 11.8' (3.6m) Jib								
	5° Tilt		25° Tilt		45° Tilt		60° Tilt		
	R	W	R	W	R	W	R	W	
82°	12.6	3,300	16.7	2,650	19.6	2,000	21.5	1,400	
80°	16.1	3,300	20.0	2,650	22.7	2,000	24.6	1,400	
77.5°	20.4	3,300	24.2	2,650	26.5	2,000	28.1	1,400	
75°	24.4	3,300	28.1	2,650	30.3	2,000	31.9	1,400	
72.5°	28.3	3,000	31.8	2,400	33.9	1,900	35.3	1,400	
70°	32.1	2,750	35.4	2,200	37.4	1,850	38.9	1,400	
67.5°	35.7	2,500	38.9	2,100	40.8	1,800	41.9	1,400	
65°	39.2	2,300	42.3	1,950	44.2	1,700	45.3	1,400	
62.5°	42.8	2,100	45.7	1,850	47.3	1,600	48.1	1,400	
60°	46.1	1,950	49.0	1,750	50.3	1,550	51.1	1,400	
57.5°	49.1	1,750	51.9	1,600	53.3	1,500			
55°	52.1	1,550	54.9	1,400	56.0	1,400			
52.5°	55.1	1,300	57.7	1,200	58.6	1,200			
50°	57.9	1,100	60.3	1,000	61.2	1,050			
47.5°	60.7	950	62.8	900	63.6	900			
45°	63.2	800	65.3	750	65.8	750			
42.5°	65.7	700	67.6	600					
40°	68.1	550	69.9	500					
37.5°	70.4	450	72.0	400					
35°	72.5	350	73.9	350					

ON OUTRIGGERS FULLY EXTENDED 15' 5" (4.7m) SPREAD 360° ROTATION									
C	78' (23.8m) Boom + 18' (5.5m) Jib								
	5° Tilt		25° Tilt		45° Tilt		60° Tilt		
	R	W	R	W	R	W	R	W	
82°	13.9	1,850	20.0	1,550	24.7	1,300	27.2	850	
80°	17.5	1,850	23.5	1,550	28.0	1,300	30.1	850	
77.5°	21.9	1,850	27.9	1,550	31.9	1,200	33.9	850	
75°	26.3	1,850	32.1	1,550	35.8	1,200	37.4	850	
72.5°	30.6	1,850	36.0	1,500	39.6	1,200	41.2	850	
70°	34.7	1,850	39.7	1,400	43.1	1,150	44.5	850	
67.5°	38.6	1,800	43.3	1,350	46.5	1,100	47.9	850	
65°	42.5	1,750	47.1	1,300	49.8	1,100	50.9	850	
62.5°	46.1	1,600	50.5	1,250	53.0	1,100	54.0	850	
60°	49.6	1,450	53.8	1,200	56.1	1,050	56.8	850	
57.5°	53.1	1,350	57.2	1,150	59.1	1,000			
55°	56.4	1,250	60.3	1,100	61.9	1,000			
52.5°	59.5	1,100	63.3	1,000	64.7	950			
50°	62.7	1,000	66.0	900	67.4	900			
47.5°	65.4	850	68.7	800	69.8	800			
45°	68.1	700	71.2	650	72.0	650			
42.5°	70.8	600	73.7	550					
40°	73.4	500	76.0	450					

ON OUTRIGGERS MID EXTENDED 14' 1-1/4" (4.3m) SPREAD 360° ROTATION									
C	78' (23.8m) Boom + 11.8' (3.6m) Jib								
	5° Tilt		25° Tilt		45° Tilt		60° Tilt		
	R	W	R	W	R	W	R	W	
82°	12.6	3,300	16.7	2,650	19.6	2,000	21.5	1,400	
80°	16.1	3,300	20.0	2,650	22.7	2,000	24.6	1,400	
77.5°	20.4	3,300	24.2	2,650	26.5	2,000	28.1	1,400	
75°	24.4	3,300	28.1	2,650	30.3	2,000	31.9	1,400	
72.5°	28.3	3,000	31.8	2,400	33.9	1,900	35.3	1,400	
70°	32.1	2,750	35.4	2,200	37.4	1,850	38.9	1,400	
67.5°	35.7	2,500	38.9	2,100	40.8	1,800	41.9	1,400	
65°	39.2	2,300	42.3	1,950	44.2	1,700	45.3	1,400	
62.5°	42.6	2,000	45.7	1,800	47.3	1,550	48.1	1,400	
60°	45.8	1,750	48.9	1,600	50.3	1,400	51.1	1,400	
57.5°	48.9	1,500	51.8	1,400	53.1	1,250			
55°	51.9	1,200	54.7	1,150	55.8	1,100			
52.5°	54.8	1,000	57.3	950	58.4	900			
50°	57.7	800	60.1	750	61.0	750			
47.5°	60.4	650	62.6	600	63.4	600			
45°	63.0	500	65.1	500	65.7	500			

ON OUTRIGGERS MID EXTENDED 14' 1-1/4" (4.3m) SPREAD 360° ROTATION									
C	78' (23.8m) Boom + 18' (5.5m) Jib								
	5° Tilt		25° Tilt		45° Tilt		60° Tilt		
	R	W	R	W	R	W	R	W	
82°	13.9	1,850	20.0	1,550	24.7	1,300	27.2	850	
80°	17.5	1,850	23.5	1,550	28.0	1,300	30.1	850	
77.5°	21.9	1,850	27.9	1,550	31.9	1,200	33.9	850	
75°	26.3	1,850	32.1	1,550	35.8	1,200	37.4	850	
72.5°	30.6	1,850	36.0	1,500	39.6	1,200	41.2	850	
70°	34.7	1,850	39.7	1,400	43.1	1,150	44.5	850	
67.5°	38.6	1,800	43.3	1,350	46.5	1,150	47.9	850	
65°	42.5	1,750	47.1	1,300	49.8	1,100	50.9	850	
62.5°	46.1	1,600	50.5	1,250	53.0	1,100	54.0	850	
60°	49.6	1,450	53.8	1,200	56.1	1,050	56.8	850	
57.5°	52.9	1,300	57.2	1,100	59.1	950			
55°	56.1	1,100	60.2	1,000	61.9	850			
52.5°	59.3	900	63.0	850	64.6	800			
50°	62.3	750	65.9	700	67.2	700			
47.5°	65.2	600	68.6	600	69.7	600			
45°	68.0	500	71.1	450	71.9	450			

**C** :Loaded boom angle (deg.)  
**R** :Load radius in feet  
**W** :Rated lifting capacity in pounds

# GR-150XL RATED LIFTING CAPACITIES (IN POUNDS)

ON OUTRIGGERS MID EXTENDED 11' 5-3/4" (3.5m) SPREAD 360° ROTATION																	
C	78' (23.8m) Boom + 11.8' (3.6m) Jib								C	78' (23.8m) Boom + 18' (5.5m) Jib							
	5° Tilt		25° Tilt		45° Tilt		60° Tilt			5° Tilt		25° Tilt		45° Tilt		60° Tilt	
	R	W	R	W	R	W	R	W		R	W	R	W	R	W	R	W
82°	12.6	3,300	16.7	2,650	19.6	2,000	21.5	1,400	82°	13.9	1,850	20.0	1,550	24.7	1,300	27.2	850
80°	16.1	3,300	20.0	2,650	22.7	2,000	24.6	1,400	80.5°	17.5	1,850	23.5	1,550	28.0	1,300	30.1	850
77.5°	20.4	3,300	24.2	2,650	26.5	2,000	28.1	1,400	77.5°	21.9	1,850	27.9	1,550	31.9	1,200	33.9	850
75°	24.4	3,300	28.1	2,650	30.3	2,000	31.9	1,400	75°	26.3	1,850	32.1	1,550	35.8	1,200	37.4	850
72.5°	28.3	2,850	31.8	2,400	33.9	1,900	35.3	1,400	72.5°	30.6	1,850	36.0	1,500	39.6	1,200	41.2	850
70°	31.8	2,400	35.4	2,200	37.4	1,850	38.9	1,400	70°	34.7	1,850	39.7	1,400	43.1	1,150	44.5	850
67.5°	35.3	2,000	38.7	1,850	40.8	1,600	41.9	1,400	67.5°	38.6	1,650	43.3	1,300	46.5	1,100	47.9	850
65°	38.7	1,550	41.9	1,500	43.8	1,400	45.3	1,400	65°	42.2	1,450	46.9	1,150	49.8	1,000	50.9	850
62.5°	42.0	1,200	45.7	1,200	46.9	1,150	47.9	1,150	62.5°	45.7	1,200	50.2	1,000	52.9	850	53.8	750
60°	45.2	900	48.9	950	49.8	900	50.7	900	60°	48.9	900	53.4	800	55.8	700	56.6	650
57.5°	48.3	700	51.8	750	52.6	700			57.5°	52.2	700	56.7	600	58.7	600		
55°	51.4	550	54.2	550	55.4	500			55°	55.6	500	59.7	450	61.6	450		

ON OUTRIGGERS MID EXTENDED 8' 2-3/8" (2.5m) SPREAD 360° ROTATION																	
C	78' (23.8m) Boom + 11.8' (3.6m) Jib								C	78' (23.8m) Boom + 18' (5.5m) Jib							
	5° Tilt		25° Tilt		45° Tilt		60° Tilt			5° Tilt		25° Tilt		45° Tilt		60° Tilt	
	R	W	R	W	R	W	R	W		R	W	R	W	R	W	R	W
82°	12.6	3,300	16.7	2,650	19.6	2,000	21.5	1,400	82°	13.9	1,850	20.0	1,550	24.7	1,300	27.2	850
80°	16.1	3,200	20.0	2,650	22.7	2,000	24.6	1,400	80°	17.5	1,850	23.5	1,550	28.0	1,300	30.1	850
77.5°	20.1	2,850	23.9	2,300	26.3	1,900	28.1	1,400	77.5°	21.9	1,850	27.7	1,500	31.9	1,200	33.9	850
75°	23.9	2,400	27.7	2,000	30.0	1,750	31.9	1,400	75°	26.3	1,850	31.9	1,400	35.7	1,100	37.4	850
72.5°	27.5	1,800	31.1	1,550	33.5	1,400	35.1	1,150	72.5°	30.2	1,500	35.5	1,100	39.1	900	41.1	750
70°	31.0	1,250	34.5	1,100	36.7	1,000	38.3	850	70°	33.9	1,100	39.3	850	42.8	750	44.4	650
67.5°	34.5	900	37.9	800	39.9	700	41.4	570	67.5°	37.6	800						
65°	37.8	550	41.1	500	43.0	450	44.3	300	65°	41.0	450						

C :Loaded boom angle (deg.)  
R :Load radius in feet  
W :Rated lifting capacity in pounds

# WARNING AND OPERATING INSTRUCTIONS FOR LIFTING CAPACITIES

## GENERAL

1. RATED LIFTING CAPACITIES apply only to the machine as originally manufactured and normally equipped by TADANO LTD. Modifications to the machine or use of optional equipment other than that specified can result in a reduction of capacity.
2. Construction equipment can be hazardous if improperly operated or maintained. Operation and maintenance of this machine must be in compliance with information in the **Operation and Maintenance Manual** supplied with this machine. If these manuals are missing, order replacement through the distributor.
3. The operator and other personnel associated with the machine shall fully acquaint themselves with the latest American National Standards Institute (ANSI) safety standards for cranes.

## SET UP

1. Rated lifting capacities on the chart are the maximum allowable crane capacities and are based on the machine standing level on firm supporting surface under ideal job conditions. Depending on the nature of the supporting surface, it may be necessary to have structural support under the outrigger floats or tires to spread the loads to larger bearing surface.
2. For outrigger operation, outriggers shall be properly extended with tires free of supporting surface before operating crane.

## OPERATION

1. Rated lifting capacities have been tested to and meet minimum requirements of SAE J1063-Cantilevered Boom Crane Structures Method of Test.
2. Rated lifting capacities do not exceed 85 % of the tipping load on outriggers fully extended as determined by SA J765-Crane Stability Test Code.  
Rated lifting capacities for partially extended outriggers are determined from the formula, Rated Lifting Capacities = (Tipping Load - 0.1 x Tip Reaction)/1.25
3. Rated lifting capacities above bold lines in the chart are based on crane strength and those below, on its stability. They are based on actual load radius increased by boom deflection.
4. The weight of handling device such as hook blocks (195lbs for 15t capacity, 53lbs for 2t capacity), slings, etc., must be considered as part of the load and must be deducted from the lifting capacities.
5. Rated lifting capacities are based on freely suspended load and make no allowance for such factors as the effect of wind, sudden stopping of loads, supporting surface conditions, inflation of tires, operating speeds, side loads, etc. Side pull on boom or jib is extremely dangerous.
6. When wind velocity is above 20mph (9m/sec), stop crane operation and stow the boom.
7. Rated lifting capacities at load radius shall not be exceeded. Do not tip the crane to determine allowable load.
8. Do not operate at boom lengths, radii, or boom angle, when no capacities are shown. Crane may overturn without any load on the hook.
9. When boom length is between values listed, refer to the rated lifting capacities of the next longer and next short booms for the same radius. The lesser of the two rated lifting capacities shall be used.
10. When making lifts at a load radius not shown, use the next longer radius to determine allowable capacity.

11. Load per line should not exceed 4,000 lbs. (1,800kg) for main winch and auxiliary winch.
12. Check the actual number of parts of line with LOAD MOMENT INDICATOR (AML-C) before operation. Maximum lifting capacity is restricted by the number of parts of line of LOAD MOMENT INDICATOR (AML-C). Limited capacity is as determined from the formula, Single line pull for main winch (4,000 lbs.) x number of parts of line.
13. The boom angle before loading should be greater to account for deflection. For rated lifting capacities, the loaded boom angle and the load radius is for reference only.
14. The 17.4' (5.3m) boom length capacities are based on boom fully retracted. If not fully retracted [less than 30'(9.0m) boom length], use the rated lifting capacities for the 30' (9.0m) boom length.
15. Extension or retraction of the boom with loads may be attempted within the limits of the RATED LIFTING CAPACITIES. The ability to telescope loads is limited by hydraulic pressure, boom angle, boom length, crane maintenance, etc.
16. For lifting capacity of single top, reduce the rated lifting capacities of relevant boom according to a weight reduction for auxiliary load handling equipment. Capacities of single top shall not exceed 4000 lbs (1,800kg) including main hook
17. When jib removing, jib state switch select removed.
18. When erecting and stowing jib, be sure to retain it by hand or by other means to prevent its free movement.
19. Use "ANTI-TWO BLOCK" disable switch when erecting and stowing jib and when stowing hook block. While the switch pushed, the hoist does not stop, even when overwind condition occurs.
20. For boom length with 11.8' (3.6m) jib, rated lifting capacities are determined by loaded boom angle only in the column headed "78' (23.8m) boom + 11.8' (3.6m) jib"  
For boom length with 18' (5.5m) jib, rated lifting capacities are determined by loaded boom angle only in the column headed "78' (23.8m) boom + 18' (5.5m) jib"  
For angles not shown, use the next lower loaded boom angle to determine allowable capacity.
21. When lifting a load by using jib (aux. winch) and boom (main winch) simultaneously, do the following
  - Enter the operation status as jib operation, not as boom operation.
  - Before starting operation, make sure that mass of load is within rated lifting capacity for jib.
22. Be very careful not to come in contact with the mirror, engine cover, etc. with following warning message. When operating crane in the following case:
  - When lowering the boom angles less than 1°
  - When swinging with the boom angles less than 1°

## DEFINITIONS

1. Load Radius: Horizontal distance from a projection of the axel of rotation to supporting surface before loading to the center of the vertical hoist line or tackle with load applied
2. Loaded Boom Angle: The angle between the boom base section and the horizontal, after lifting the rated lifting capacity at the load radius
3. Working Area: Area measured in a circular arc about the centerline of rotation
4. Freely Suspended Load: Load hanging free with no direct external force applied except by the hoist line
5. Side Load: Horizontal side force applied to the lifted load either on the ground or in the air

# GR-150XL RATED LIFTING CAPACITIES (IN POUNDS)

ON RUBBER STATIONARY												
A	Over Front					360° Rotation						
	17.4'		30'		42'	17.4'		30'		42'		
B	C	(5.3m)	C	(9.0m)	C	(12.7m)	C	(5.3m)	C	(9.0m)	C	(12.7m)
4	70.3	7,900	79.0	7,900			70.3	6,200	79.0	6,200		
6	62.7	7,650	74.9	7,650	79.4	7,900	62.7	6,200	74.9	6,200	79.4	6,150
8	54.4	6,900	70.8	6,900	76.6	6,900	54.4	4,900	70.8	4,800	76.6	4,700
10	44.4	5,750	66.5	5,650	73.6	5,500	44.4	3,450	66.5	3,350	73.6	3,200
12	30.7	4,850	62.2	4,600	70.7	4,350	30.7	2,500	62.2	2,350	70.7	2,100
15			55.2	3,450	66.2	3,000			55.2	1,000	66.2	750
20			41.7	1,900	58.3	1,700						
25			19.2	550	49.4	650						
D	0°				42°			0°		44°		60°

LIFTING CAPACITIES AT ZERO DEGREE BOOM ANGLE ON RUBBER STATIONARY											
A	Over Front					360° Rotation					
	17.4'		30'		42'	17.4'		30'		42'	
C	B	(5.3m)	B	(9.0m)				B	(5.3m)		
0°	13.1	4,200	25.3	500				13.1	1,600		

ON RUBBER CREEP									
A	Over Front								
	17.4'		30'		42'				
B	C	(5.3m)	C	(9.0m)	C	(12.7m)			
4	70.3	7,050	79.0	7,050					
6	62.7	6,750	74.9	6,750	79.4	7,050			
8	54.4	6,200	70.8	6,100	76.6	5,900			
10	44.4	5,200	66.5	4,950	73.6	4,750			
12	30.7	4,150	62.2	4,000	70.7	3,750			
15			55.2	3,000	66.2	2,700			
20			41.7	1,700	58.3	1,500			
25			19.2	500	49.4	650			
D	0°				42°				

LIFTING CAPACITIES AT ZERO DEGREE BOOM ANGLE ON RUBBER CREEP							
A	Over Front						
	17.4'		30'		42'		
C	B	(5.3m)	B	(9.0m)			
0°	13.1	3,600	25.3	400			

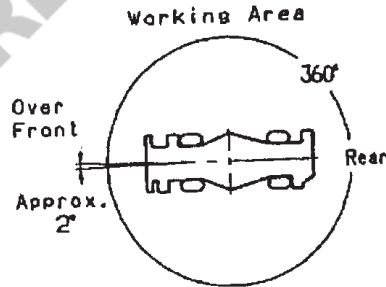

- A** : Boom length in feet
- B** : Load radius in feet
- C** : Loaded boom angle (deg.)
- D** : Minimum boom angle (deg.) for indicated length (no load)

**NOTE:**

The lifting capacity data stored in the LOAD MOMENT INDICATOR (AML-C) is based on the standard number of parts of line listed in the chart.

Standard number of parts of line for on rubber operation should be according to the following table.

Boom Length in Feet (meters)	17.4' to 42' (5.3m to 12.7m)	Single top
Number of parts of line	4	1

# WARNING AND OPERATING INSTRUCTIONS FOR ON RUBBER LIFTING CAPACITIES

- Rated lifting capacities on rubber are in pounds and do not exceed 75 % of tipping loads as determined by SAE J765- Crane Stability Test Code.
- Rated lifting capacities shown in the chart are based on condition that crane is set on firm level surfaces with suspension-lock applied. Those above bold lines are based on tire capacity and those below, on crane stability. They are based on actual load radius increased by tire deformation and boom deflection.
- Rated lifting capacities are based on proper tire inflation, capacity and condition. Damaged tires are hazardous to safe operation of crane.
- Tires shall be inflated to correct air pressure.

Tires	Air Pressure
275/80R22.5	130 psi (9.0 kgf/cm <sup>2</sup> )

- Over-front operation shall be performed within two degrees in front of chassis.
- On rubber lifting with "jib" is not permitted. Maximum permissible boom length is 42' (12.7m).
- When making lift on rubber stationary, set parking brake.
- For creep operation, boom must be centered over-front of machine, swing lock engaged, and load restrained from swinging. Travel slowly and keep the lifted load as close to the ground as possible, and especially avoid any abrupt steering, accelerating or braking.
- Do not operate the crane while carrying the load.
- Creep is motion for crane not to travel more than 200 ft (60m) in any 30 minute period and to travel at the speed of less than 1 mph (1.6km/h).
- For creep operation, set Drive select switch to "4-WHEEL (Lo)" and set gear shift lever to "1".

# WARNING AND OPERATING INSTRUCTIONS FOR USING THE LOAD MOMENT INDICATOR (AML-C)

- When operating crane on outriggers:
  - Before outrigger operation, suspension-lock in the over-front area of the boom. (Locking and releasing cannot be performed in other state.)
  - Keep pressing the switch to the "LOCK" side until the suspension-lock confirmation lamp changes from flashing to lighting, and lower the body to the full. (Outrigger operation and crane operation cannot be performed without suspension-locking.)
  - Set "P.T.O." switch to "ON".
  - Press the outrigger state select key to register the outrigger operation. If the display agree with the actual state, press the set key to register. After the completion of the registration, the pop-up window closes.
  - Press the lift state select key to register the lift state to be used (single top/jib/boom). Each time lift state select key is pressed, the display changes. If the display agree with the actual state, press the set key to register. After the completion of the registration, the pop-up window closes.
- When operating crane on rubber:
  - Suspension-lock in the over-front area of the boom. (Locking and releasing cannot be performed in other state.)
  - Keep pressing the switch to the "LOCK" side until the suspension-lock confirmation lamp changes from flashing to lighting, and lower the body to the full. (Crane operation cannot be performed without suspension-locking.)
  - Set "P.T.O." switch to "ON".
  - Press the outrigger mode select key. On rubber state symbol comes on. Each time the outrigger mode select key is pressed the mode changes. Select the creep operation, the on-tire mode indicative symbol flicker.
  - Press the boom mode select key to register the boom mode. However, pay attention to the following.
    - For stationary operation.
      - The front capacities are attainable only when the over-front position symbol comes on. When the boom is more than 2 degrees from centered over-front of chassis, 360° capacities are in effect.
      - When a load is lifted in the front position and then swung to the side area, make sure the value of the LOAD MOMENT INDICATOR (AML-C) is below the 360° lifting capacity.
    - For creep operation.
      - The creep capacities are attainable only when boom is in the straight forward position of chassis and the over-front position symbol is on. If boom is not in the straight forward position of chassis, never lift load.
- This machine is equipped with an automatic swing stopping device. (For the details, see Operation Maintenance Manual.) But, operate very carefully because the automatic swing stop does not work in the following cases.
  - During on rubber operation.
  - When the "P.T.O." switch is set to "OVERRIDE" and the "OVERRIDE" key switch outside the cab is on.
- During crane operation, make sure that the displays on front panel are in accordance with actual operating conditions.
- The displayed values of LOAD MOMENT INDICATOR (AML-C) are based on freely suspended loads and make no allowance for such factors as the effect of wind, sudden stopping of loads, supporting surface conditions, inflation of tire, operating speed, side loads, etc. For safe operation, it is recommended when extending and lowering boom or swinging, lifting loads shall be appropriately reduced.
- LOAD MOMENT INDICATOR (AML-C) is intended as an aid to the operator. Under no condition should it be relied upon to replace use of capacity charts and operating instruction. Sole reliance upon LOAD MOMENT INDICATOR (AML-C) aids in place of good operating practice can cause an accident. The operator must exercise caution to assure safety.
- The lifting capacity for over-side area differs depending on the outrigger extension width. Work with the capacity corresponding to the extension width. The lifting capacities for over-front and over-rear areas are for "outriggers fully extended". However, the areas (angle a°) differ depending on the outrigger extension width.

Extended Width	14' 1-1/4" (4.3m)	11' 5-3/4" (3.5m)	8' 2-3/8" (2.5m)	5' 4-1/2" (1.64m)
Angle a°	70 (middle)	60 (middle)	55 (middle)	50 (minimum)

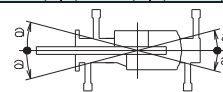

## GR-150XL Axle weight distribution chart

	Pounds			Kilograms		
	GVW	Front	Rear	GVW	Front	Rear
Base machine with 2 stage jib, auxiliary lifting sheeve and auxiliary hoist	30,780	15,190	15,590	13,960	6,890	7,070
Remove: 1. 2-stage jib (11.8', 18')	-410	-490	80	-185	-221	36
2. 2.0 ton (1.8 metric ton) hook ball and auxiliary lifting sheave (single top)	-120	-340	220	-53	-155	102

# MEMO

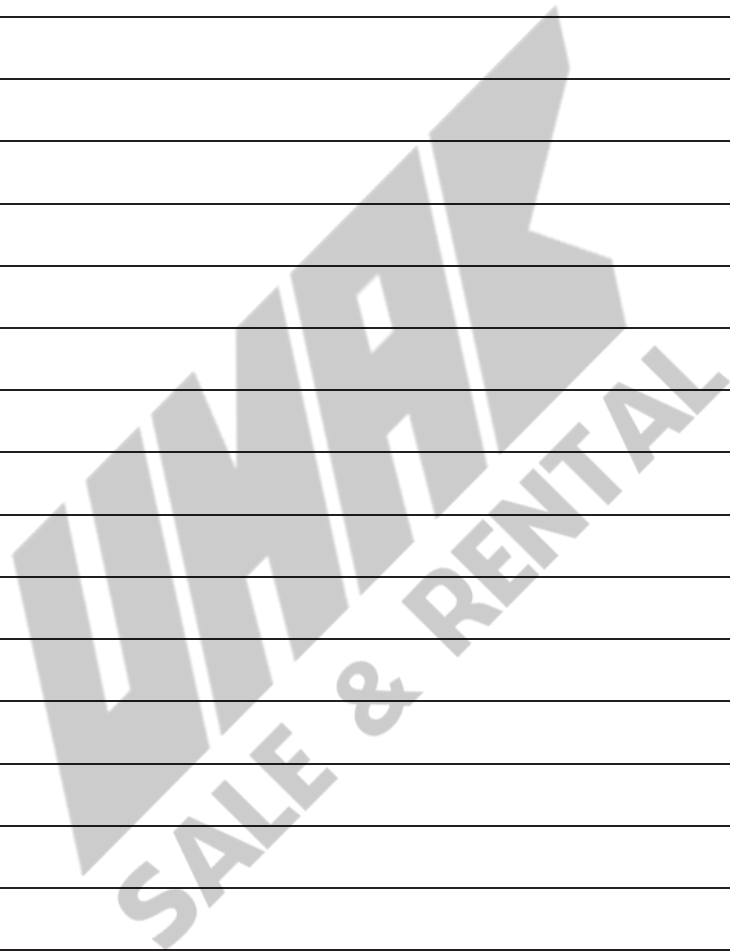

# MEMO

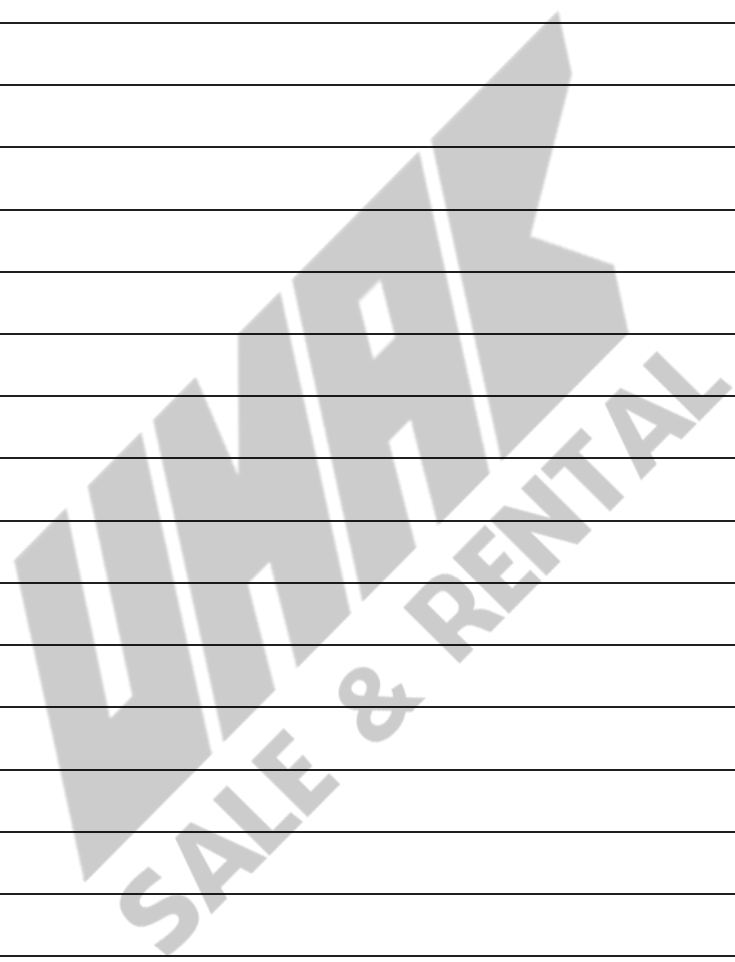

# MEMO

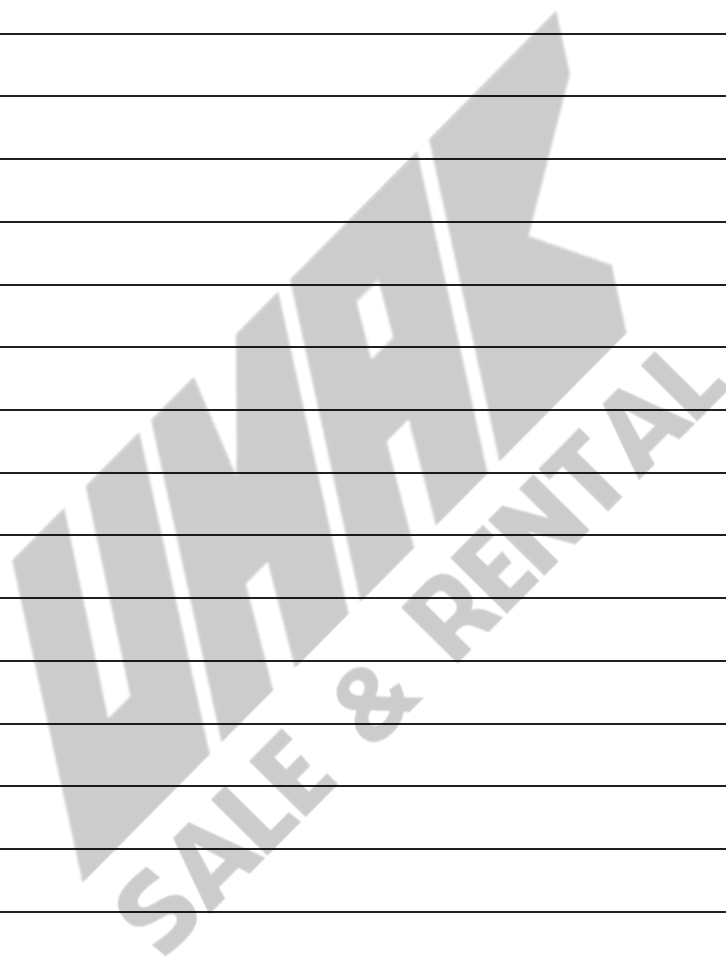

**TADANO AMERICA CORPORATION**

4242 WEST GREENS ROAD  
HOUSTON, TEXAS, 77066 U.S.A.  
PHONE: (281) 869-0030  
FAX: (281) 869-0040  
Parts Hotline: (281) 869-0033  
Service Hotline: (281) 869-5925  
Web site: [www.tadanoamerica.com](http://www.tadanoamerica.com)  
E-mail: [sales@tadano-cranes.com](mailto:sales@tadano-cranes.com)  
**Form No. TAC GR-150XL-1-090604**