

ATF 400G-6

400 METRISCHE TONNEN TRAGLAST / 400 METRIC TON CAPACITY

ALL
TERRAIN
CRANE



Hubhöhen + Anbauteile
 Lifting heights + Attachment
 Hauteurs de levage + Attachement
 Alturas de elevación + Elemento de construcción



ATF 400G-6

DIN/ISO/EN

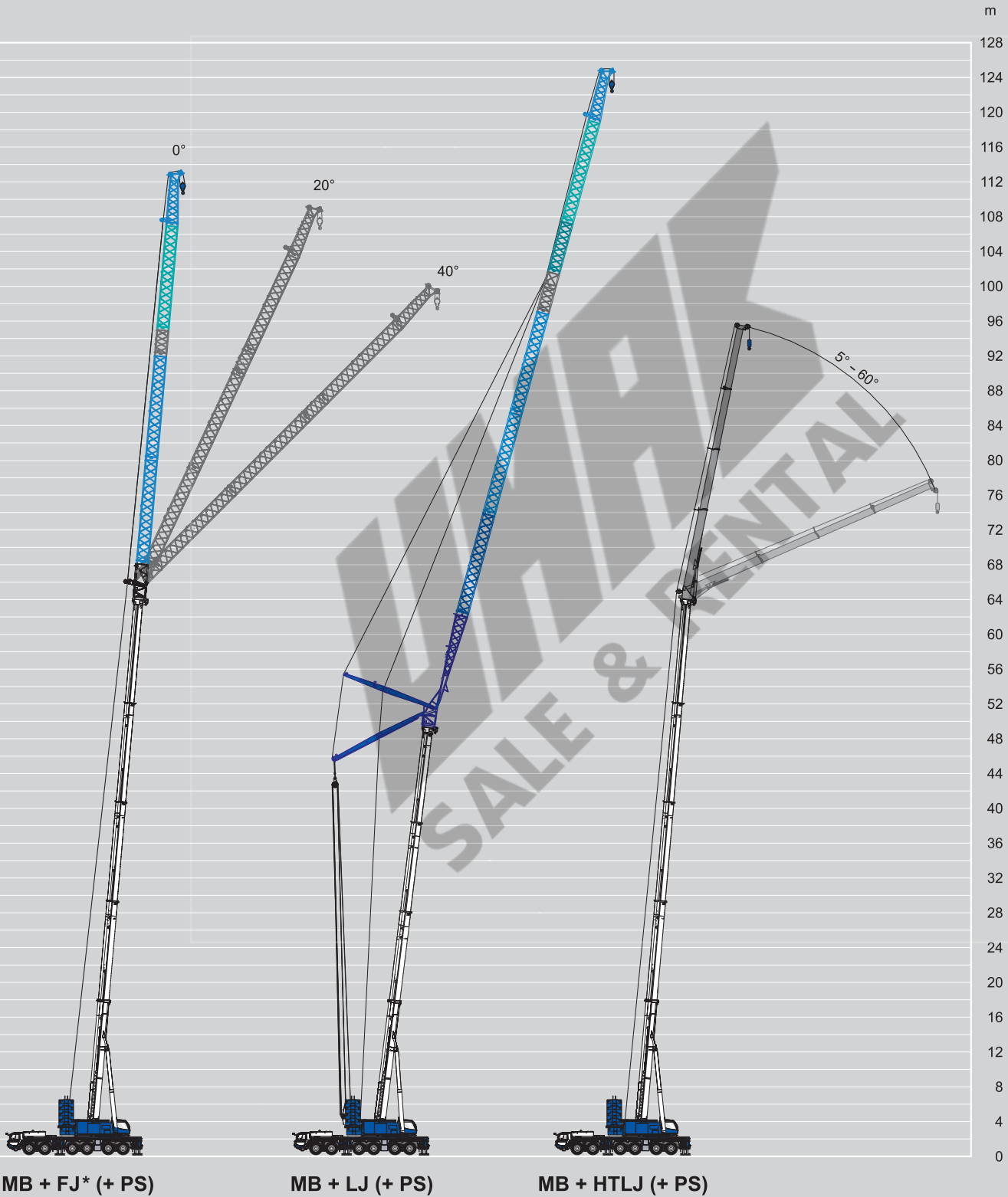

*) Mechanisch / Hydraulisch *) Mechanical / Hydraulic *) Mécanique / Hydraulique *) Mecánico / Hidráulico

Highlights

Highlights des ATF 400G-6:

- Einhaltung der 12 t Achslasten inkl. Antrieb 12 x 8 x 12, Bereifung 445/95 R 25 (16.00 R 25).
- Leistungsstärkstes Antriebspaket seiner Klasse mit sparsamen Mercedes Benz BlueTec Motor, 480 kW Leistung und 3000 Nm Drehmoment sowie einem hochtechnisiertem ZF-TC-Tronic HD Getriebe in "Heavy Duty" Ausführung.
- Separater Oberwagenmotor von Mercedes Benz mit BlueTec Technologie und 195 kW Leistung und 1100 Nm Drehmoment.
- Der 60 m Hauptausleger erreicht die höchsten Traglastwerte seiner Klasse. Zum Vergrößern der Traglasten kann er zusätzlich mit einem "Power System" ausgerüstet werden.
- Vollhydraulisch abwinkelbare und teleskopierbare Auslegerverlängerung (HTLJ) für effizientes Arbeiten und Montage auf engstem Raum (Funktion wie zusätzlicher Teleskopausleger).
- Der Standardlieferungsumfang umfasst das volle Gegengewicht von 138 t und 4 Abstützbasen.
- Fahrzeugbreite innerhalb von 3 m bei einem Gegengewicht bis zu 25 t.
- Das Sicherheitsprogramm 'Lift- und Release Adjuster' unterbindet das gefährliche Pendeln der Last, bzw. des Hakens und sorgt somit für höchste Sicherheit und äußerst kontrollierbare Hubbewegungen bei jedem Einsatz.
- Effiziente Serviceplanung sowie Durchführung von Fehlerferndiagnosen/-behebungen mit Unterstützung der Online-Kommunikation zwischen Kranhersteller, Kranbetreiber und Kran (Hello-Net).

Points forts de l' ATF 400G-6:

- 12 t par essieu avec entraînement 12 x 8 x 12, pneus 445/95 R 25 (16.00 R 25).
- La chaîne d'entraînement la plus performante de sa catégorie avec le dernier développement et un moteur Mercedes Benz Blue Tec sophistiqué qui économise le plus la consommation de gazole, puissance 480 kW et 3000 Nm couple ainsi qu'une transmission haute technologie ZF-TC-Tronic HD transmission en version « poids lourds ».
- Moteur Mercedes Benz BlueTec pour la superstructure, puissance 195 kW et 1100 Nm couple.
- La flèche principale de 60 m atteint la plus grande capacité dans sa classe. La flèche principale peut être équipée en supplément avec le « Power System » pour augmenter la capacité de levage.
- Le système de la fléchette avec inclinaison et télescopage hydraulique (HTLJ) est conçu pour les opérations dans des espaces limités. (comme une flèche additionnelle au bout de la flèche télescopique).
- Le contrepoids de 138 t et le dispositif de calage en 4 points est standard.
- Jusqu'à 25 t de contrepoids la largeur du véhicule n'est pas dépassé.
- Les dispositifs de sécurité 'Lift- et Release Adjuster' évitent le balancement dangereux de la charge et du moufle et garantissent une sécurité supérieure et mouvement de levage qui sont contrôlables sur chaque levage.
- Planning du service efficient ainsi qu'un diagnostic de dysfonctionnement, ajustement et corrections peuvent être opérés par communication en ligne (Hello-Net) entre le fabricant, le client et la grue.

Highlights of the ATF 400G-6:











- 12 t axle load including drive 12 x 8 x 12, tyres 445/95 R 25 (16.00 R 25).
- The most powerful drive system in his class with the latest state of the art fuel saving Mercedes Benz BlueTec engine, 480 kW engine power and 3000 Nm torque as well as a high technology ZF-TC-Tronic HD transmission in "heavy duty" version.
- Separate superstructure engine Mercedes Benz BlueTec engine, 195 kW engine power and 1100 Nm torque.
- The 60 m main boom achieves the highest capacity in his class. The main boom can be additionally equipped with the "Power System" to increase the lifting capacity.
- The Hydraulic Telescopic Luffing Jib (HTLJ) is made to be fitted and operate in narrow areas (like an additional telescopic boom on top of the main telescopic boom).
- The 138 t counterweight and 4 outrigger bases are standard.
- With up to 25 t counterweight the vehicle width is not exceeded.
- The safety features 'Lift- and Release Adjuster' avoiding of dangerous swing of the load and the hook block and providing highest safety and controllable lifting motions on each job.
- Efficient Service planning as well as malfunction diagnostic, adjustment and corrections can be made via online-communication (Hello-Net) between the manufacturer, the client and the crane.





Highlights del ATF 400G-6:

- Peso por eje de 12 t incluido, tracción 12 x 8 x 12, neumáticos 445/95 R 25 (16.00 R 25).
- Paquete de potencia con motor Mercedes Benz BlueTec 480 kW y 3000 Nm de par motor. Caja de cambios de alta tecnología modelo ZF-TC en versión "heavy duty".
- Motor independiente de grúa Mercedes Benz Blue Tec de 195 kW y 1100 Nm de par motor.
- Longitud de pluma de 60 m. Con las mejores tablas de carga en su categoría. Mejora de tablas de carga con el montaje adicional del "Power System".
- Plumin adicional con funciones hidráulicas de teléscopaje y angulación (HTLJ). Optimización de espacios en zonas reducidas (funciona como pluma adicional tipo JIB).
- Maquina base con 138 t. De contrapeso. Estabilizadores hidráulicos de 4 puntos.
- Ancho de maquina de 3 m incluido contrapeso de hasta 25 t.
- Programa de seguridad 'Lift- and Release Adjuster', controla los posibles movimientos oscilantes del gancho, asegurado en cada movimiento el máximo control de la carga.
- Planificación eficiente de servicio técnico mediante un servicio de diagnosis de averías Online de comunicación creando una red entre Fabricante – Usuario – Grúa (Hello-Net).

Seite / Page Page / Pagina	Gegengewicht / Counterweight Contrepoids / Contrapeso	Systemübersicht / General survey of the system Vue d'ensemble du système / Sistema de vigilancia	
3-9		Auslegerverlängerungen / Boom extensions / Fléchette / Plumin	1
10-11		Gegengewichtvarianten / Counterweight versions / Variations des contrepoids / Variaciones de contrapeso	
12-13		Maße + Gewichte / Geschwindigkeiten / Dimensions + Weights / Working speeds / Dimensiones + Poids / Vitesses / Dimensiones + Pesos / Velocidades de trabajo	
14-19	138 t / 118 t / 98 t / 78 t / 58 t	MB Teleskopausleger / Telescopic boom / Flèche télescopique / Pluma telescópica	2
20-22	47 t / 36 t / 25 t / 16.5 t / 7.5 t		
23	0 t		
24-25	138 t	MB + PS Teleskopausleger / Telescopic boom / Flèche télescopique / Pluma telescópica + Power-System	3
26	118 t		
27	98 t		
28-30	138 t / 118 t	MB + LFJ Teleskopausleger / Telescopic boom / Flèche télescopique / Pluma telescópica + Light fixed jib	4
31	78 t		
32	58 t		
34-36	138 t / 118 t	MB + LFJ + PS Teleskopausleger / Telescopic boom / Flèche télescopique / Pluma telescópica + Light fixed jib + Power-System	5
37	78 t		
38	58 t		
40-42	138 t / 118 t / 58 t Heavy Duty	MB + FJ Teleskopausleger / Telescopic boom / Flèche télescopique / Pluma telescópica + Fixed jib	6
44-52	138 t / 118 t		
53-56	58 t		
58-60	138 t / 118 t / 58 t Heavy Duty	MB + FJ + PS Teleskopausleger / Telescopic boom / Flèche télescopique / Pluma telescópica + Fixed jib + Power-System	7
62-70	138 t / 118 t		
71-73	58 t		
74-88	138 t	MB + LJ Teleskopausleger / Telescopic boom / Flèche télescopique / Pluma telescópica + Luffing jib	8
89-96	78 t		
98-105	138 t	MB + LJ + PS Teleskopausleger / Telescopic boom / Flèche télescopique / Pluma telescópica + Luffing jib + Power-System	9
106-111	118 t / 58 t	MB + HTLJ Teleskopausleger / Telescopic boom / Flèche télescopique / Pluma telescópica + Hydraulic telescopic luffing jib	10
112-115	118 t		
		MB + HTLJ + PS Teleskopausleger / Telescopic boom / Flèche télescopique / Pluma telescópica + Hydraulic telescopic luffing jib + Power-System	11
116		Anmerkungen zu den Traglasttabellen / Remarks relating to the rating charts / Remarques relatives aux tableaux des charges / Notas relativas a los graficos de carga	12
117-120		Ausrüstung / Equipment / Equipement / Equipo	
121		Symbolerklärung / Symbols / Glossaire des symboles / Glosario de simbolos	

LJ Übersicht
 LJ General survey
 LJ Vue d'ensemble
 LJ Sistema de vigilancia

 LJ	DIN / ISO / EN
2.5 m + 20.3 m	
2.5 m + 32.3 m	
2.5 m + 34.0 m	
2.5 m + 40.0 m	
2.5 m + 46.0 m	
2.5 m + 52.0 m	
2.5 m + 58.0 m	
2.5 m + 64.0 m	
2.5 m + 70.0 m	
2.5 m + 76.0 m	

 Light	DIN / ISO / EN
2.5 m + 46.0 m	
2.5 m + 52.0 m	
2.5 m + 58.0 m	
2.5 m + 64.0 m	

FJ Übersicht + Teile
 FJ General survey + parts
 FJ Vue d'ensemble + parts
 FJ Sistema de vigilancia + parte



DIN / ISO / EN

Heavy Duty 2.0 m + 3.5 m (5.5 m)	
2.0 m + 11.5 m (13.5 m)	
2.0 m + 17.5 m (19.5 m)	
2.0 m + 23.5 m (25.5 m)	
2.0 m + 29.5 m (31.5 m)	
2.0 m + 35.5 m (37.5 m)	
2.0 m + 41.5 m (43.5 m)	
2.0 m + 47.5 m (49.5 m)	

Abmessungen + Gewichte / Dimensions + Weights / Dimensiones + Poids / Dimensiones + Pesos

<p>1</p> <p>Wippbasiseinheit / Luffing base jib assembly / Unité de base pour la volée variable / Tijera de abatible 12 m</p> <p>Länge / Length / Longueur / Largo: 13.575 m Breite / Width / Large / Ancho: 2.044 m Höhe / Height / Hauteur / Altura: 3.071 m Gewicht / Weight / Poid / Peso: 9105 kg</p>	<p>2</p> <p>Zwischenstück / Intermediate section / Section intermédiaire / Tramo intermedio 12 m</p> <p>Länge / Length / Longueur / Largo: 12.162 m Breite / Width / Large / Ancho: 1.836 m Höhe / Height / Hauteur / Altura: 1.520 m Gewicht / Weight / Poid / Peso: 2370 kg</p>	<p>3</p> <p>Zwischenstück / Intermediate section / Section intermédiaire / Tramo intermedio 12 m</p> <p>Länge / Length / Longueur / Largo: 12.162 m Breite / Width / Large / Ancho: 1.836 m Höhe / Height / Hauteur / Altura: 1.520 m Gewicht / Weight / Poid / Peso: 2047 kg</p>	<p>4</p> <p>Reduzierstück / Reducer / Adaptateur conico de "LJ a FJ" 3 m</p> <p>Länge / Length / Longueur / Largo: 3.162 m Breite / Width / Large / Ancho: 1.836 m Höhe / Height / Hauteur / Altura: 1.506 m Gewicht / Weight / Poid / Peso: 710 kg</p>	<p>5</p> <p>Abspannstück / Pendant connector section / Chevalet de haubanage / Arranque inicio plumin ligero 1,74 m</p> <p>Länge / Length / Longueur / Largo: 1.909 m Breite / Width / Large / Ancho: 1.056 m Höhe / Height / Hauteur / Altura: 1.518 m Gewicht / Weight / Poid / Peso: 600 kg</p>
<p>6</p> <p>Zwischenstück / Intermediate section / Section intermédiaire / Tramo intermedio 6 m</p> <p>Länge / Length / Longueur / Largo: 6.162 m Breite / Width / Large / Ancho: 1.081 m Höhe / Height / Hauteur / Altura: 1.475 m Gewicht / Weight / Poid / Peso: 900 kg</p>	<p>7</p> <p>Zwischenstück / Intermediate section / Section intermédiaire / Tramo intermedio 12 m</p> <p>Länge / Length / Longueur / Largo: 12.162 m Breite / Width / Large / Ancho: 1.081 m Höhe / Height / Hauteur / Altura: 1.475 m Gewicht / Weight / Poid / Peso: 1550 kg</p>	<p>8</p> <p>Auslegerspitze / Jib top section / Fléchette / Punta de plumin 6 m</p> <p>Länge / Length / Longueur / Largo: 6.515 m Breite / Width / Large / Ancho: 1.128 m Höhe / Height / Hauteur / Altura: 2.021 m Gewicht / Weight / Poid / Peso: 1386 kg</p>	<p>9</p> <p>Abwinkelstück / Adapter fixed jib / Adaptateur de flèche / Adaptador de pluma 4.15 m</p> <p>Länge / Length / Longueur / Largo: 4.312 m Breite / Width / Large / Ancho: 2.045 m Höhe / Height / Hauteur / Altura: 2.798 m Gewicht / Weight / Poid / Peso: 2164 kg</p>	<p>10</p> <p>Schwerlastkopf / Heavy duty top section / Tête d'élément pour levage lourd / Cabezal 1 m</p> <p>Länge / Length / Longueur / Largo: 1.473 m Breite / Width / Large / Ancho: 1.747 m Höhe / Height / Hauteur / Altura: 2.595 m Gewicht / Weight / Poid / Peso: 579 kg</p>

LJ Transport-Beispiel + Maße (mm)
 LJ Transport example + dimensions (mm)
 LJ Exemple de transport + dimensions (mm)
 LJ Ejemplo de transportes + dimensiones (mm)

- 1** Wippbasiseinheit
 Luffing base jib assembly
 Unité de base pour la volée variable
 Tijera de abatible
- 11** Montagewagen
 Assembly dolly
 Dolly de montage
 Carro auxiliar de montaje



Gewicht / Weight /
 Poids / Peso: 400 kg

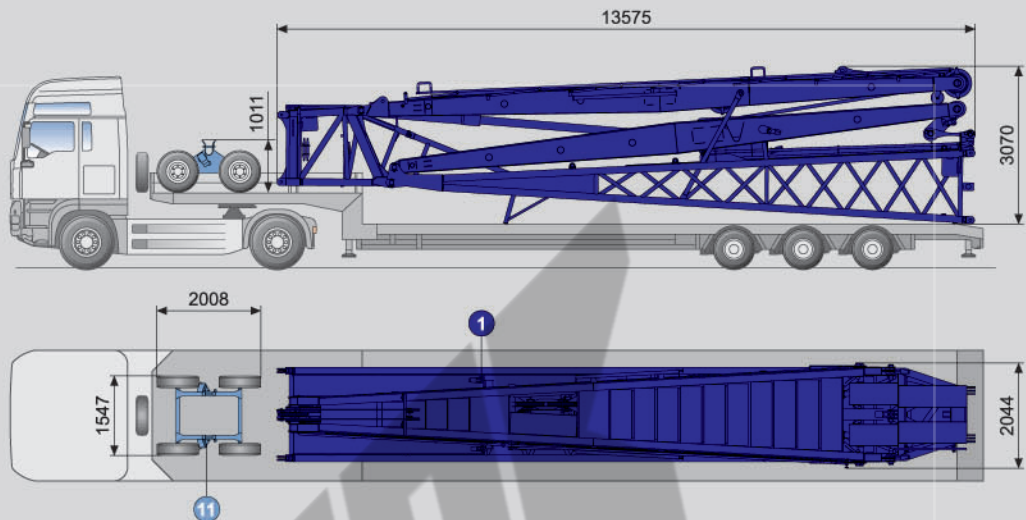

- 2** Zwischenstück
 Intermediate section
 Section intermédiaire
 Tramo intermedio
- 4** Reduzierstück
 Reducer
 Adaptateur / Adaptador
 conico de "LJ a FJ"
- 5** Abspannstück
 Pendant connector section
 Chevalet de haubanage
 Arranque abatible
- 6** Zwischenstück
 Intermediate section
 Section intermédiaire
 Tramo intermedio
- 7** Zwischenstück
 Intermediate section
 Section intermédiaire
 Tramo intermedio
- 8** Auslegerspitze
 Jib top section
 Fléchette
 Punta de plumín

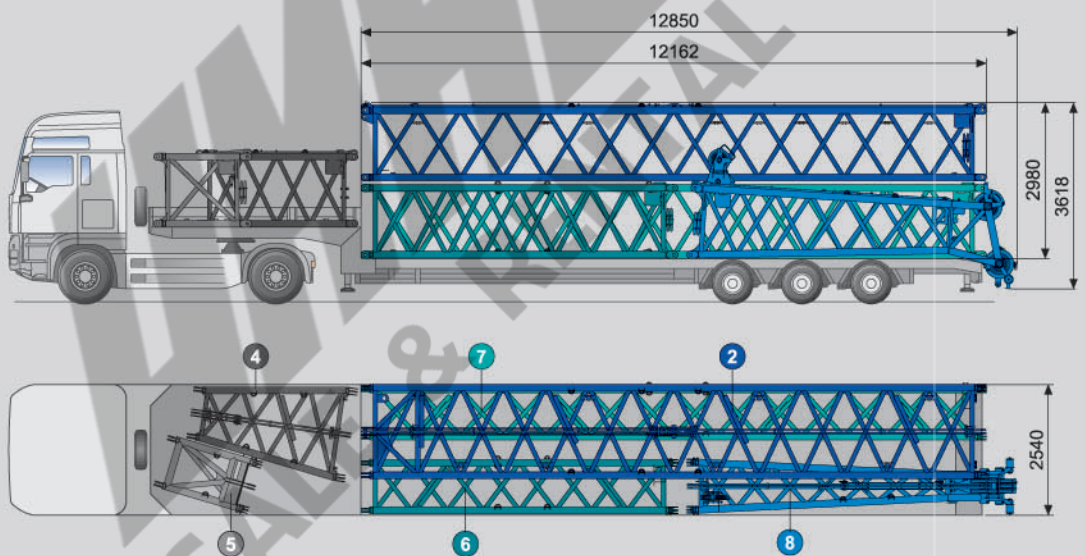

- 3** Zwischenstück
 Intermediate section
 Section intermédiaire
 Tramo intermedio
- 12** Wippenverstelleinheit
 (Hubwerk 2 und eingescherter Rollenträger)
 Luffing assembly (Hoist 2 with reeved sheave set)
 Unité pour réglage de la volée variable (2ième treuil avec support des poulies)
 Sección intermedia, portapoleas 2º cabestrante

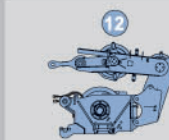

Gewicht / Weight /
 Poids / Peso: 5704 kg

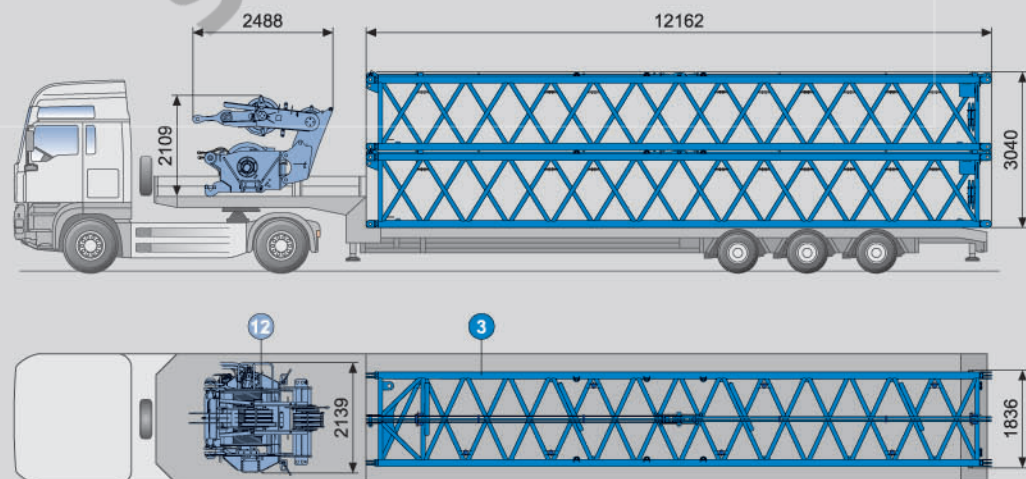

HTLJ / PS Transport-Beispiel + Maße (mm)
 HTLJ / PS Transport example + dimensions (mm)
 HTLJ / PS Exemple de transport + dimensions (mm)
 HTLJ / PS Ejemplo de transportes + dimensiones (mm)

1 HTLJ

Maße (mm)
 Dimensions (mm)
 Dimensiones (mm)
 Transportgewicht
 Transport weight
 Transport de poids
 Transporte de peso
 10150 kg

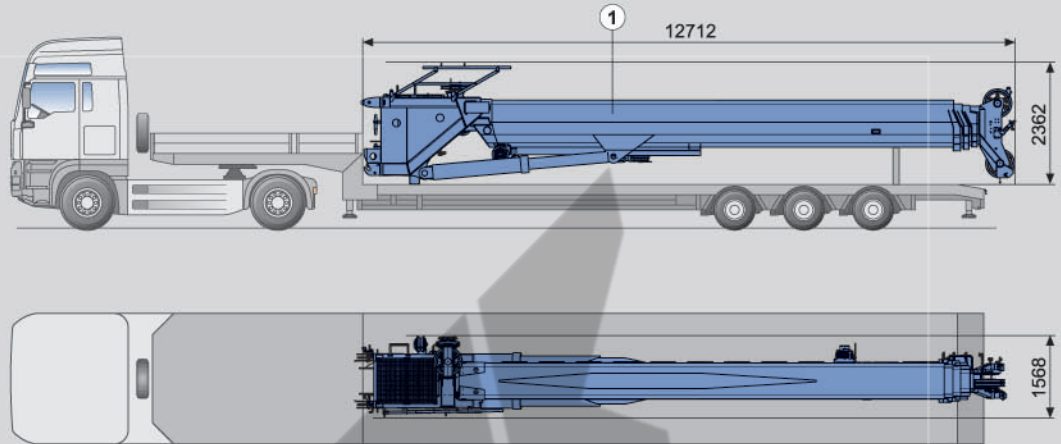
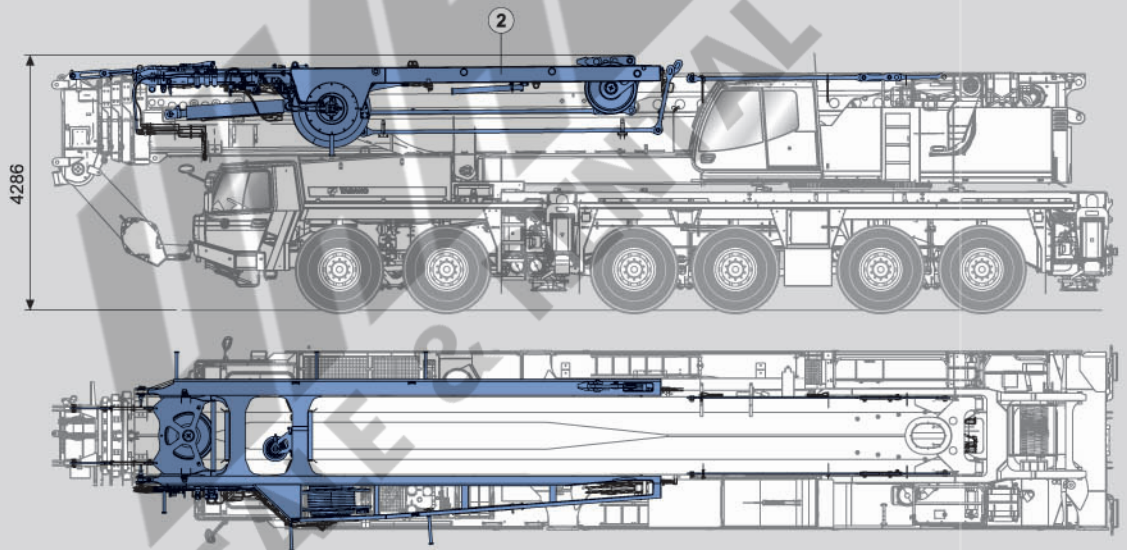

2 Power-System (PS)

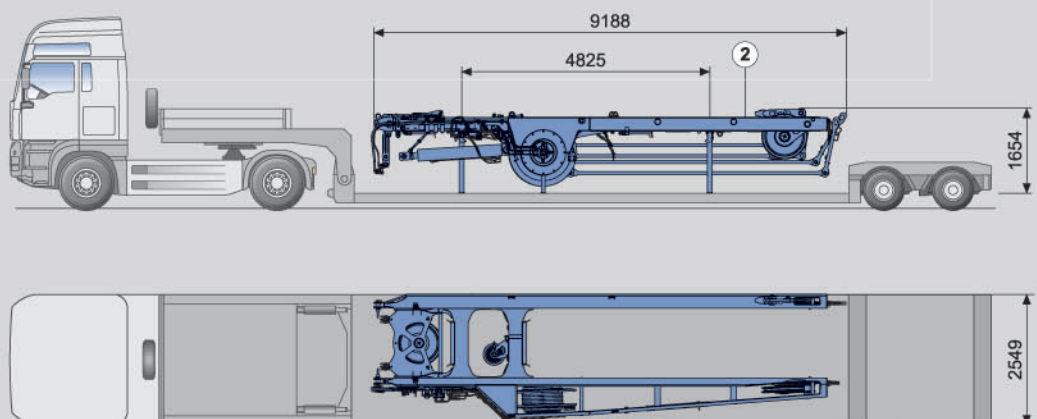
2 Power-System (PS)

Maße (mm)
 Dimensions (mm)
 Dimensiones (mm)
 Transportgewicht
 Transport weight
 Transport de poids
 Transporte de peso
 6790 kg

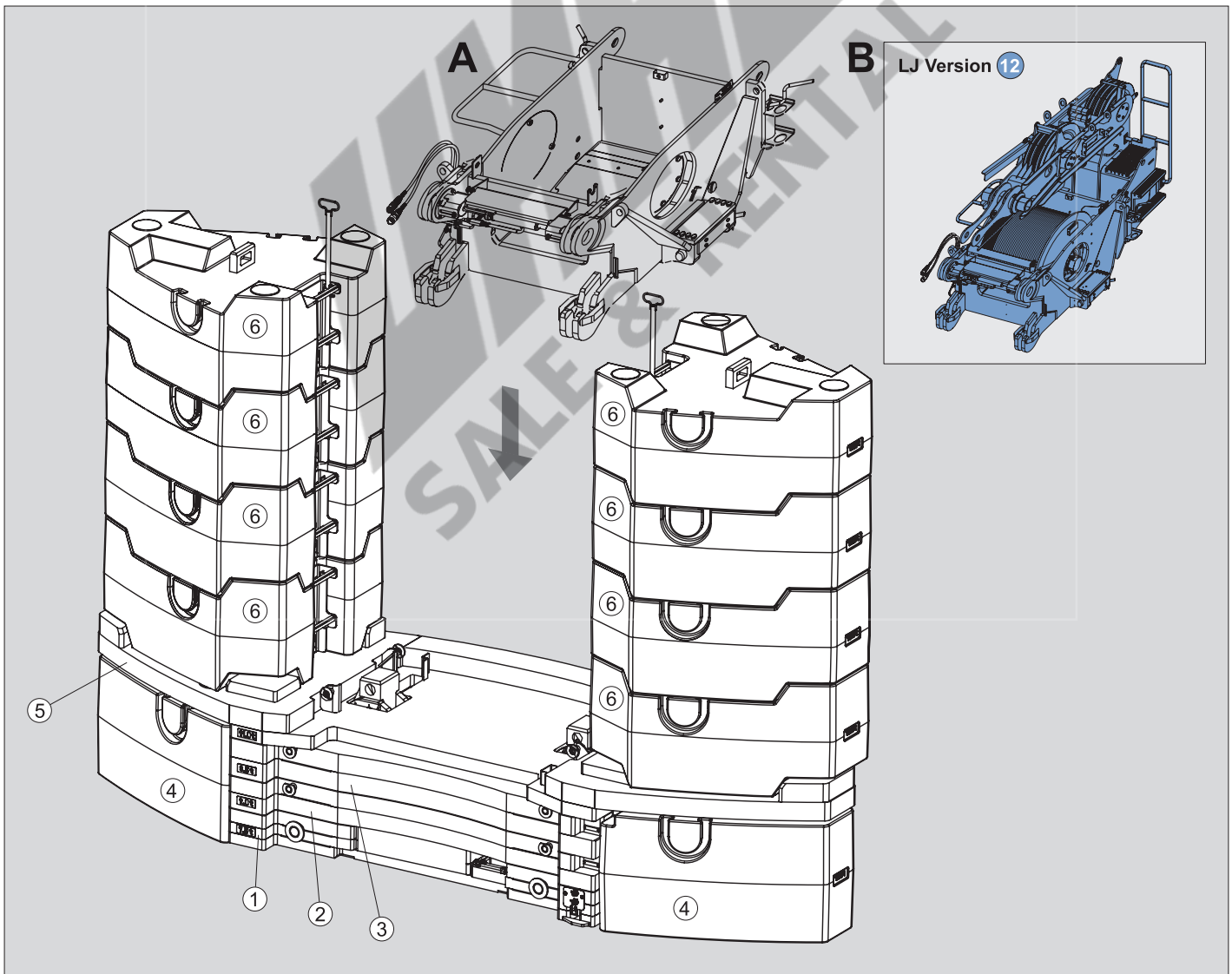
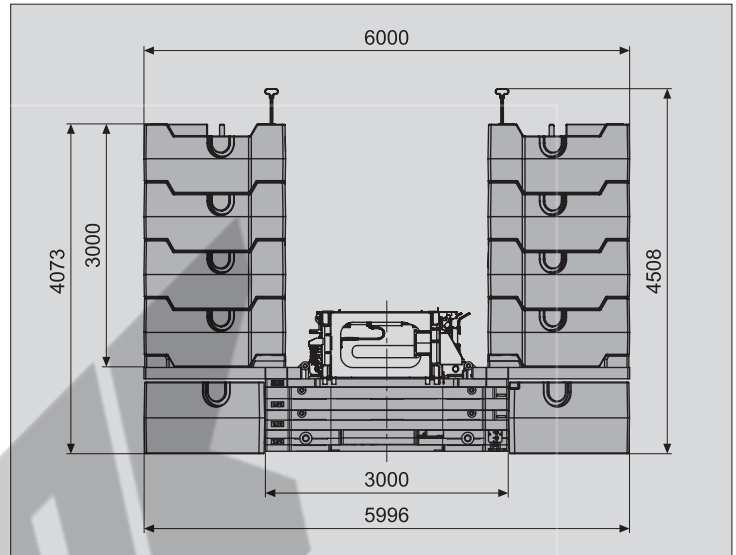

Gegengewichtvarianten
Counterweight versions
Variations des contrepoids
Variaciones de contrapeso

Gesamtgewicht Total weight Poids total Peso total	Gegengewicht / Counterweight / Contrepoids / Contrapeso					
	7.5 t ①	9 t ②	8.5 t ③	11 t ④	11 t ⑤	10 t ⑥
138 t	1	1	1	2	1	8
118 t	1	1	1	2	1	6
98 t	1	1	1	2	1	4
78 t	1	1	1	2	1	2
58 t	1	1	1	2	1	
47 t	1	1	1	2		
36 t	1	1	1		1	
25 t	1	1	1			
16.5 t	1	1				
7.5 t	1					



Gegengewichtvarianten
Counterweight versions
Variations des contrepoids
Variaciones de contrapeso

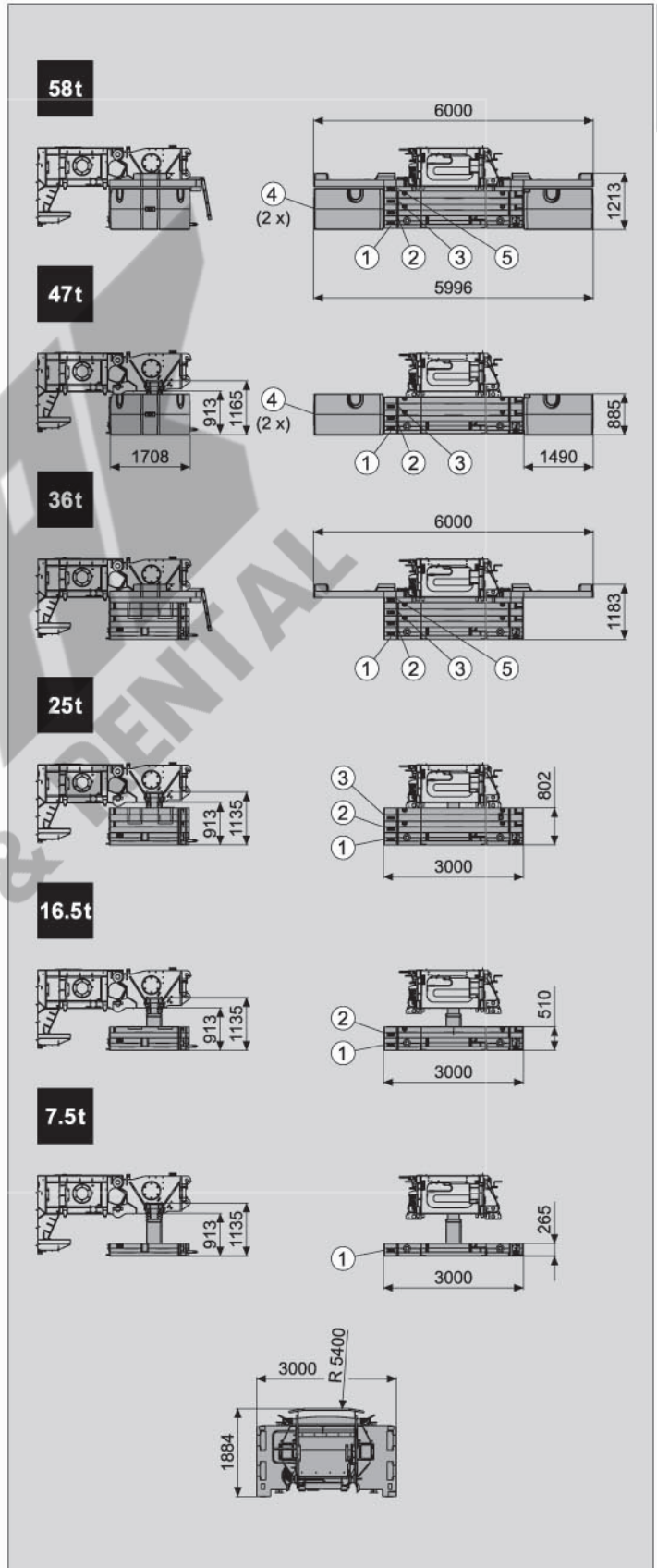
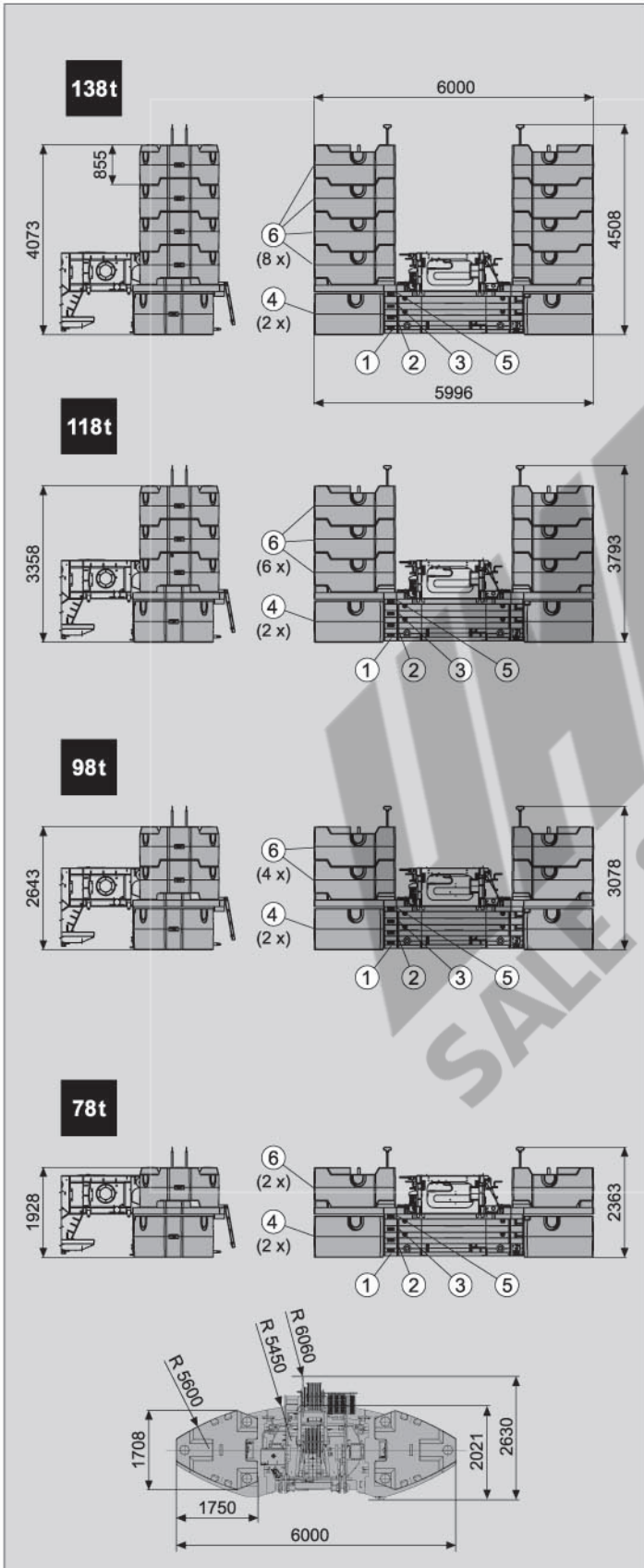

Maße (mm)
 Dimensions (mm)
 Dimensiones (mm)

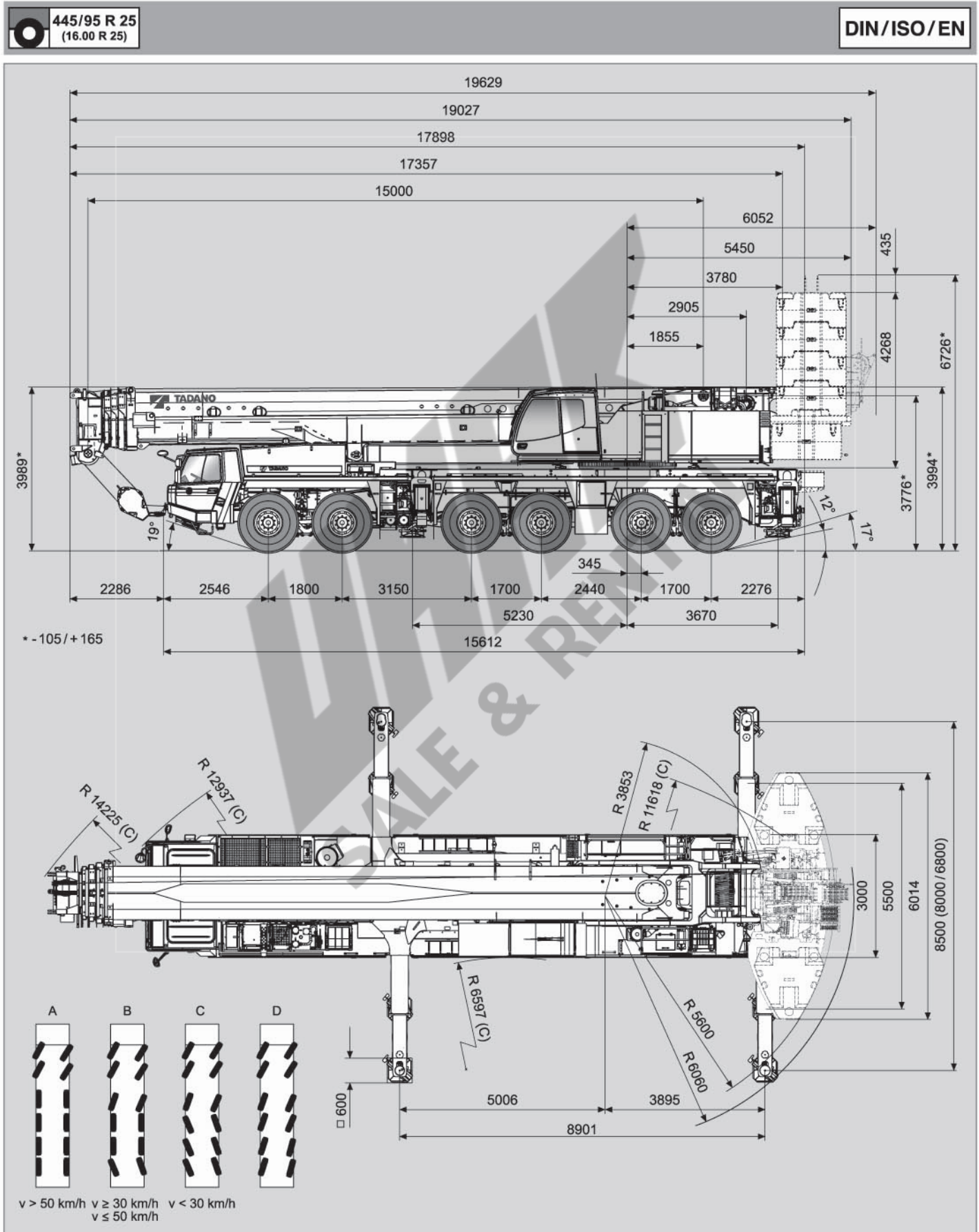

Gewichte / Geschwindigkeiten
Weights / Working speeds
Poids / Vitesses
Pesos / Velocidades de trabajo

	Achse / Axle Essieu / Eje	1	2	3	4	5	6	Gesamtgewicht / Total weight Poids total / Peso total
	(t)	12	12	12	12	12	12	72*

* Incl. 12,5 t Hakengeschrir, Werkzeugkasten, Antrieb 12 x 8 x 12, Bereifung 445/95 R 25 (16.00 R 25).

* Incl. 12.5 t swivel hook, toolbox, drive 12 x 8 x 12, tyres 445/95 R 25 (16.00 R 25).

* Incl. 12,5 t elingues, boîte à outils, entraînement 12 x 8 x 12, pneus 445/95 R 25 (16.00 R 25).

* Incl. 12,5 t gancho de bola, caja de herramientas, tracción 12 x 8 x 12, neumáticos 445/95 R 25 (16.00 R 25).

	Traglast / Lifting capacity / Force de levage / Capacidad de elevación	Rollen / Sheaves Pulies / Poleas	Stränge / Parts of line Brins / Ramales de cable	Gewicht / Weight Poid / Peso
	250 t*	9	19	2700 kg
	200 t*	7	15	2300 kg
	160 t*	5	11	1800 kg
	100 t*	3	7	1550 kg
	40 t	1	3	600 kg/950 kg
	12.5 t	–	1	410 kg

* Doppelhaken

* Rams horn

* Moufle avec crochet marin

* Gancho doble



	1	2	3	4	5	6	7	8	9	10	11	12	R1	R2	
385/95 R 25 (14.00 R 25)	3.6	4.6	5.9	7.6	9.6	12.3	16.3	20.9	27.0	34.6	43.9	56.3	3.9	4.9	60.0%*
km/h	5.5	7.0	9.1	11.7	14.8	19.0	25.1	32.1	41.6	53.3	67.5	85.0	5.9	7.6	54.9%
445/95 R 25 (16.00 R 25)	3.9	5.0	6.4	8.3	10.5	13.4	17.7	22.7	29.4	37.7	47.7	61.2	4.2	5.4	53.5%*
km/h	6.0	7.7	9.9	12.7	16.1	20.6	27.3	35.0	45.2	58.0	73.5	85.0	6.5	8.3	49.2%

* Mit Geländeübersetzung
* Off road range

* Avec mode tout terrain
* Con transmisión todo terreno

	Stufenlos Infinitely variable Progressivement variable Infinitamente variable	Seil Rope Câble Cable	Seilzug Single line pull Effort au brin simple Trio por ramal
	0 - 125 m/min für einfachen Strang single line au brin simple ramal simple	23 mm / 350 m	120 kN
	0 - 125 m/min für einfachen Strang single line au brin simple ramal simple	23 mm / 580 m	120 kN
	0 - 1.1 min ⁻¹		
	- 0.8° - +83.5° ca. 50 s approx. 50 s env. 50 s aproximadamente 50 s		
	15.0 m - 60.0 m ca. 500 s approx. 500 s env. 500 s aproximadamente 500 s		

Hubhöhen
Lifting heights
Hauteurs de levage
Alturas de elevación

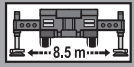
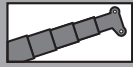

138t

DIN/ISO/EN

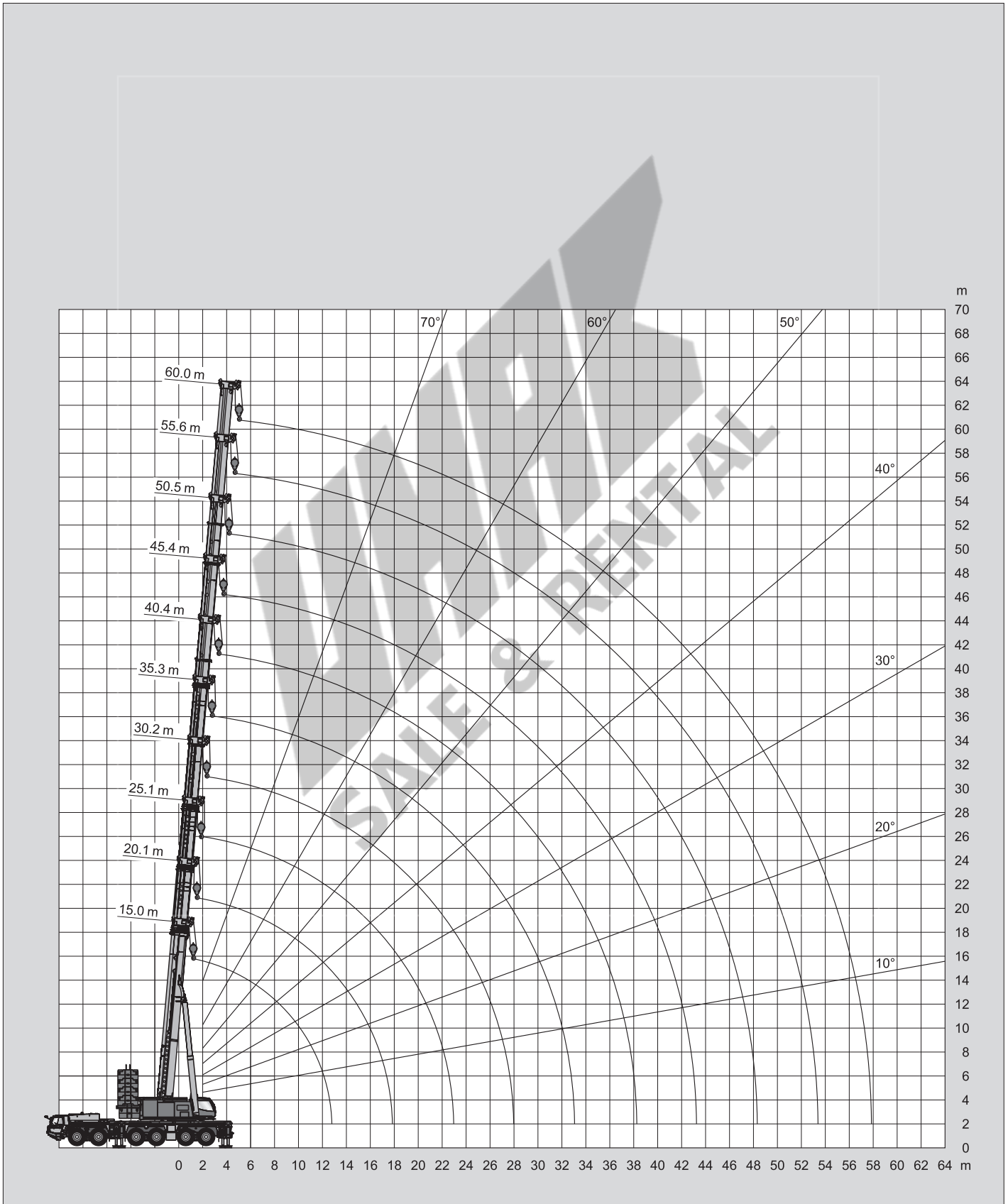

Tragfähigkeiten
Lifting capacities
Capacités de levage
Capacidades de elevación

				138t	118t ¹⁾	DIN / ISO / EN				
--	---	---	---	-------------	---------------------------	-----------------------	--	--	--	--

 1 m	15.0 m*	15.0 m	20.1 m	25.1 m	30.2 m	35.3 m	40.4 m	45.4 m	50.5 m	55.6 m	60.0 m
2.7	400.0										
3.0	360.0	1) 200.0	170.0	162.0							
3.5	307.0	200.0	170.0	162.0							
4.0	264.6	200.0	170.0	162.0	139.0						
4.5	230.0	195.1	170.0	162.0	139.0						
5.0	200.6	182.9	170.0	162.0	139.0	123.4					
6.0		164.2	162.1	158.4	139.0	113.8	84.2				
7.0		147.4	146.0	141.2	127.9	103.1	84.2	71.6			
8.0		133.0	131.9	127.4	118.2	94.2	84.2	71.6	54.3		
9.0		120.4	120.0	116.0	109.8	86.7	79.5	69.5	54.3	45.0	
10.0		109.8	109.4	107.0	102.6	81.2	73.6	65.7	54.3	45.0	38.0
11.0		97.5	100.3	98.9	96.3	76.5	68.5	62.4	54.0	45.0	38.0
12.0		83.4	92.4	91.7	89.8	72.3	64.0	59.3	50.9	44.6	38.0
14.0			78.6	79.5	78.4	65.3	56.5	52.7	45.6	40.4	38.0
16.0			64.1	69.4	69.2	59.5	50.5	47.1	41.3	36.9	35.0
18.0			41.9	60.3	61.4	54.8	45.6	42.6	37.6	33.9	32.3
20.0				52.0	54.6	50.8	41.6	38.8	34.6	31.4	29.6
22.0				40.5	48.3	47.3	38.1	35.5	32.0	29.0	27.2
24.0					42.0	44.4	35.2	32.7	29.7	26.9	25.1
26.0					36.5	40.7	32.6	30.3	27.7	25.1	23.3
28.0					24.4	36.1	30.4	28.3	26.0	23.5	21.7
30.0						31.1	28.3	26.4	24.5	22.1	20.3
32.0						24.5	26.3	24.8	23.1	20.8	19.0
34.0							24.5	23.5	21.9	19.6	17.9
36.0							22.0	22.3	20.8	18.6	16.7
38.0							15.0	20.9	19.6	17.7	15.6
40.0								19.7	18.4	16.8	14.5
42.0								16.0	17.3	16.1	13.6
44.0									16.3	15.4	12.7
46.0									15.4	14.7	12.0
48.0									11.5	14.0	11.2
50.0										13.2	10.6
52.0										11.6	10.0
54.0											9.4
56.0											8.9
58.0											6.2

MB

1) 360° Traglasten < 8 m Arbeitsradius max. 118 t Gegengewicht / 360° Lifting capacities < 8 m working radius max. 118 t counterweight / 360° forces de levage < 8 m portée max. 118 t contrepoids / 360° capacidades de elevación < 8 m radio de giro max. 118 t contrapeso
 *) Arbeitsbereich 0° mit Schwerlasteinrichtung, Zentralabstützung, Zusatzrollen und Hubwerk 2
 *) Working area 0° with heavy duty attachment, center support, additional sheaves and auxiliary winch
 *) Limitation de zone 0° avec équipement du levage lourd, calage central, rouleau supplémentaire et 2^{ème} treuil de levage
 *) Limitación del área 0° con equipo adicional carga pesada, estabilizador central, poleas adicionales y cabestrante 2

Tragfähigkeiten
Lifting capacities
Capacités de levage
Capacidades de elevación

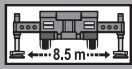
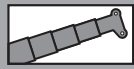
118t
DIN / ISO / EN

 m	15.0 m	20.1 m	25.1 m	30.2 m	35.3 m	40.4 m	45.4 m	50.5 m	55.6 m	60.0 m
3.0	200.0	170.0	162.0							
3.5	200.0	170.0	162.0							
4.0	200.0	170.0	162.0	139.0						
4.5	195.1	170.0	162.0	139.0						
5.0	182.9	170.0	162.0	139.0	123.4					
6.0	162.3	162.1	158.4	139.0	113.8	84.2				
7.0	144.2	143.9	141.2	127.9	103.1	84.2	71.6			
8.0	129.3	128.9	127.4	118.2	94.2	84.2	71.6	54.3		
9.0	116.9	116.5	115.8	109.8	86.7	79.5	69.5	54.3	45.0	
10.0	106.4	106.0	105.9	102.6	81.2	73.6	65.7	54.3	45.0	38.0
11.0	97.5	97.0	97.0	96.3	76.5	68.5	62.4	54.0	45.0	38.0
12.0	83.4	89.3	89.3	89.4	72.3	64.0	59.3	50.9	44.6	38.0
14.0		76.6	76.5	76.7	65.3	56.5	52.7	45.6	40.4	38.0
16.0		64.1	66.2	66.3	59.5	50.5	47.1	41.3	36.9	35.0
18.0		41.9	58.9	58.1	54.8	45.6	42.6	37.6	33.9	32.3
20.0			51.0	50.1	50.8	41.6	38.8	34.6	31.4	29.6
22.0			40.5	43.8	44.9	38.1	35.5	32.0	29.0	27.2
24.0				40.3	39.7	35.2	32.7	29.7	26.9	25.1
26.0				36.5	35.5	32.6	30.3	27.7	25.1	23.3
28.0				24.4	32.0	30.4	28.3	26.0	23.5	21.7
30.0					29.0	28.1	26.4	24.5	22.1	20.3
32.0					24.5	25.5	24.8	23.1	20.8	19.0
34.0						23.1	23.5	21.9	19.6	17.9
36.0						21.1	21.9	20.8	18.6	16.7
38.0						15.0	20.1	19.6	17.7	15.6
40.0							18.5	18.4	16.8	14.5
42.0							16.0	17.0	16.1	13.6
44.0								15.7	15.4	12.7
46.0								14.6	14.7	12.0
48.0								11.5	13.8	11.2
50.0									12.8	10.6
52.0									11.6	10.0
54.0										9.4
56.0										8.9
58.0										6.2

Tragfähigkeiten
Lifting capacities
Capacités de levage
Capacidades de elevación

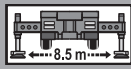
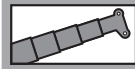

98 t

DIN / ISO / EN

→ 1 m	15.0 m	20.1 m	25.1 m	30.2 m	35.3 m	40.4 m	45.4 m	50.5 m	55.6 m	60.0 m
3.0	200.0	170.0	162.0							
3.5	200.0	170.0	162.0							
4.0	200.0	170.0	162.0	139.0						
4.5	192.9	170.0	162.0	139.0						
5.0	180.6	170.0	162.0	139.0	123.4					
6.0	158.0	157.6	157.0	139.0	113.8	84.2				
7.0	139.9	139.6	138.9	127.9	103.1	84.2	71.6			
8.0	125.2	124.8	124.1	118.2	94.2	84.2	71.6	54.3		
9.0	112.9	112.5	112.5	109.8	86.7	79.5	69.5	54.3	45.0	
10.0	102.6	102.2	102.2	102.4	81.2	73.6	65.7	54.3	45.0	38.0
11.0	93.5	93.1	93.0	93.2	76.5	68.5	62.4	54.0	45.0	38.0
12.0	83.4	85.1	85.0	85.2	72.3	64.0	59.3	50.9	44.6	38.0
14.0		71.9	72.8	72.0	65.3	56.5	52.7	45.6	40.4	38.0
16.0		59.2	60.1	59.2	59.5	50.5	47.1	41.3	36.9	35.0
18.0		41.9	50.8	50.0	51.1	45.6	42.6	37.6	33.9	32.3
20.0			43.8	44.8	43.9	41.6	38.8	34.6	31.4	29.6
22.0			38.3	39.3	38.4	37.7	35.5	32.0	29.0	27.2
24.0				34.8	33.8	33.0	32.7	29.7	26.9	25.1
26.0				31.0	29.9	29.2	29.6	27.7	25.1	23.3
28.0				24.4	26.8	25.9	26.8	26.0	23.5	21.7
30.0					24.1	23.2	24.0	24.0	22.1	20.3
32.0					21.8	20.8	21.7	21.7	20.8	19.0
34.0						18.8	19.6	19.6	19.6	17.9
36.0						17.1	17.9	17.8	18.2	16.7
38.0						15.0	16.3	16.4	16.6	15.6
40.0							14.9	15.6	15.2	14.5
42.0							13.7	14.7	13.9	13.6
44.0								13.5	12.8	12.7
46.0								12.6	11.8	11.8
48.0								11.5	10.9	10.9
50.0									10.0	10.0
52.0									9.3	9.3
54.0										8.6
56.0										7.9
58.0										6.2

MB

Tragfähigkeiten
Lifting capacities
Capacités de levage
Capacidades de elevación

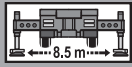
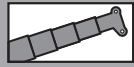
78t
DIN / ISO / EN

 m	15.0 m	20.1 m	25.1 m	30.2 m	35.3 m	40.4 m	45.4 m	50.5 m	55.6 m	60.0 m
3.0	200.0	170.0	162.0							
3.5	200.0	170.0	162.0							
4.0	200.0	170.0	162.0	139.0						
4.5	189.0	170.0	162.0	139.0						
5.0	175.6	170.0	162.0	139.0	123.4					
6.0	153.2	152.8	152.2	139.0	113.8	84.2				
7.0	135.3	134.9	134.3	127.9	103.1	84.2	71.6			
8.0	120.8	120.4	120.3	118.2	94.2	84.2	71.6	54.3		
9.0	107.9	107.5	107.5	107.7	86.7	79.5	69.5	54.3	45.0	
10.0	97.2	96.7	96.7	95.7	81.2	73.6	65.7	54.3	45.0	38.0
11.0	88.2	87.7	87.6	84.7	76.5	68.5	62.4	54.0	45.0	38.0
12.0	77.4	76.8	77.8	75.8	72.3	64.0	59.3	50.9	44.6	38.0
14.0		60.8	61.7	60.9	61.5	56.5	52.7	45.6	40.4	38.0
16.0		51.7	50.7	51.9	51.1	49.4	47.1	41.3	36.9	35.0
18.0		41.9	44.1	43.8	43.0	42.3	41.8	37.6	33.9	32.3
20.0			37.9	37.5	36.6	35.8	36.3	34.6	31.4	29.6
22.0			33.0	32.5	31.5	30.8	31.7	31.8	29.0	27.2
24.0				28.5	27.5	26.7	27.6	27.7	26.9	25.1
26.0				25.3	24.2	23.4	24.3	24.3	24.7	23.3
28.0				22.7	21.5	20.6	21.5	22.0	21.9	21.7
30.0					19.2	18.3	19.2	20.3	19.6	19.7
32.0					17.3	17.3	17.6	18.2	17.5	17.6
34.0						16.4	16.6	16.5	15.7	15.9
36.0						15.6	15.4	14.9	14.2	14.3
38.0						14.7	14.0	13.5	12.8	12.9
40.0							12.8	12.3	11.6	11.7
42.0							11.8	11.2	10.5	10.6
44.0								10.3	9.5	9.6
46.0								9.4	8.6	8.7
48.0								8.7	7.8	7.9
50.0									7.1	7.2
52.0									6.5	6.5
54.0										5.9
56.0										5.4
58.0										4.9

Tragfähigkeiten
Lifting capacities
Capacités de levage
Capacidades de elevación

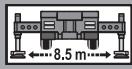
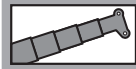

58 t

DIN / ISO / EN

 1 m	15.0 m	20.1 m	25.1 m	30.2 m	35.3 m	40.4 m	45.4 m	50.5 m	55.6 m	60.0 m
3.0	200.0	170.0	162.0							
3.5	200.0	170.0	162.0							
4.0	198.5	170.0	162.0	139.0						
4.5	183.3	170.0	162.0	139.0						
5.0	170.0	169.6	162.0	139.0	123.4					
6.0	147.8	147.4	146.8	139.0	113.8	84.2				
7.0	129.3	128.9	128.9	123.7	103.1	84.2	71.6			
8.0	113.9	113.4	110.3	103.7	94.2	84.2	71.6	54.3		
9.0	101.2	100.0	95.3	88.8	85.9	79.5	69.5	54.3	45.0	
10.0	85.0	84.4	82.8	77.4	75.3	70.8	65.7	54.3	45.0	38.0
11.0	72.9	72.4	72.9	71.1	66.9	63.0	61.0	54.0	45.0	38.0
12.0	63.6	65.1	64.1	63.7	59.9	56.5	55.0	50.9	44.6	38.0
14.0		51.5	52.1	51.9	49.3	46.5	46.0	44.5	40.4	38.0
16.0		41.8	42.4	42.1	41.1	38.9	38.8	37.6	36.9	35.0
18.0		35.0	35.3	35.0	34.0	33.0	33.1	32.5	31.7	31.0
20.0			29.9	29.5	28.5	27.7	28.6	29.2	27.5	27.0
22.0			26.0	25.2	24.2	24.1	25.4	25.6	24.1	23.7
24.0				23.0	20.8	22.3	22.6	22.1	21.3	20.9
26.0				20.4	18.4	20.2	19.7	19.3	18.6	18.6
28.0				18.3	17.2	17.9	17.4	16.9	16.2	16.4
30.0					15.9	15.9	15.4	15.0	14.2	14.4
32.0					14.4	14.2	13.7	13.3	12.5	12.7
34.0						12.8	12.3	11.8	11.1	11.2
36.0						11.6	11.0	10.5	9.8	9.9
38.0						10.6	9.9	9.4	8.7	8.8
40.0							8.9	8.4	7.7	7.8
42.0							8.1	7.5	6.8	6.9
44.0								6.8	6.0	6.1
46.0								6.1	5.3	5.4
48.0								5.5	4.7	4.7
50.0									4.1	4.1
52.0									3.6	3.6
54.0										3.1
56.0										2.7
58.0										2.3

MB

SALE & RENTAL

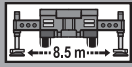
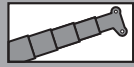

Tragfähigkeiten
Lifting capacities
Capacités de levage
Capacidades de elevación



47t
DIN / ISO / EN

 m	15.0 m	20.1 m	25.1 m	30.2 m	35.3 m	40.4 m	45.4 m	50.5 m	55.6 m	60.0 m
3.0	200.0	170.0	162.0							
3.5	200.0	170.0	162.0							
4.0	195.3	170.0	162.0	139.0						
4.5	180.1	170.0	162.0	139.0						
5.0	166.8	166.4	162.0	139.0	123.4					
6.0	144.2	143.8	143.0	137.2	113.8	84.2				
7.0	125.0	124.6	119.6	111.3	103.1	84.2	71.6			
8.0	109.8	106.5	100.6	93.1	89.4	83.3	71.6	54.3		
9.0	89.9	89.3	85.6	81.5	77.1	72.1	69.3	54.3	45.0	
10.0	75.3	74.8	74.2	72.1	67.5	63.3	61.1	54.3	45.0	38.0
11.0	64.5	66.0	65.0	63.8	59.8	56.2	54.5	52.9	45.0	38.0
12.0	56.2	57.6	58.2	57.0	53.5	50.2	49.4	47.5	44.6	38.0
14.0		45.4	46.0	45.8	43.4	40.7	40.4	39.0	38.2	37.2
16.0		37.0	37.6	37.3	36.1	33.8	33.8	34.1	32.1	31.4
18.0		30.6	31.1	30.6	29.5	28.7	30.6	29.2	27.4	26.8
20.0			26.2	26.9	24.6	26.2	26.5	25.3	23.7	23.2
22.0			22.5	23.0	21.5	23.1	22.6	22.1	20.6	20.2
24.0				20.0	19.8	19.9	19.4	19.0	18.1	17.8
26.0				17.5	17.3	17.4	16.9	16.4	15.7	15.7
28.0				15.7	15.2	15.3	14.8	14.3	13.6	13.8
30.0					13.5	13.5	13.0	12.5	11.8	12.0
32.0					12.1	12.0	11.5	11.0	10.3	10.4
34.0						10.7	10.2	9.7	9.0	9.1
36.0						9.6	9.0	8.6	7.8	8.0
38.0						8.7	8.1	7.6	6.8	6.9
40.0							7.2	6.7	5.9	6.0
42.0							6.5	5.9	5.2	5.2
44.0								5.2	4.5	4.5
46.0								4.6	3.8	3.9
48.0								4.1	3.3	3.3
50.0									2.7	2.8
52.0									2.3	2.3
54.0										1.9
56.0										1.5

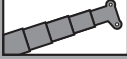
SALE & RENTAL

Tragfähigkeiten
Lifting capacities
Capacités de levage
Capacidades de elevación

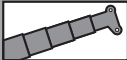
  36t DIN / ISO / EN										
→ m	15.0 m	20.1 m	25.1 m	30.2 m	35.3 m	40.4 m	45.4 m	50.5 m	55.6 m	60.0 m
3.0	200.0	170.0	162.0							
3.5	200.0	170.0	162.0							
4.0	192.1	170.0	162.0	139.0						
4.5	177.0	170.0	162.0	139.0						
5.0	163.7	163.4	162.0	139.0	123.4					
6.0	139.8	139.3	131.2	120.1	109.8	84.2				
7.0	120.9	113.6	106.2	97.2	92.5	84.2	71.6			
8.0	97.9	92.8	87.9	84.2	78.0	72.4	69.2	54.3		
9.0	79.4	78.2	74.6	72.1	67.1	62.5	60.6	54.3	45.0	
10.0	66.4	68.0	66.5	62.8	58.3	54.3	52.9	50.5	45.0	38.0
11.0	56.7	58.2	58.3	55.0	51.1	47.6	46.8	45.9	43.5	38.0
12.0	49.2	50.7	51.3	48.7	45.3	42.2	41.7	41.5	39.0	37.8
14.0		39.2	39.9	39.2	36.4	35.2	35.9	34.1	31.9	31.1
16.0		31.0	31.8	32.5	30.0	31.6	30.0	28.5	26.7	26.0
18.0		25.5	26.0	26.8	25.8	26.9	25.5	24.2	22.6	22.1
20.0			21.7	22.4	22.3	22.6	22.0	20.8	19.3	18.9
22.0			18.5	19.1	18.9	19.1	18.6	18.0	16.7	16.3
24.0				16.4	16.2	16.4	15.9	15.4	14.4	14.2
26.0				14.3	14.1	14.2	13.7	13.2	12.5	12.3
28.0				12.7	12.3	12.3	11.8	11.4	10.7	10.8
30.0					10.8	10.8	10.3	9.8	9.1	9.2
32.0					9.6	9.5	9.0	8.5	7.8	7.9
34.0						8.4	7.8	7.3	6.6	6.7
36.0						7.4	6.8	6.4	5.6	5.7
38.0						6.7	6.0	5.5	4.8	4.9
40.0							5.2	4.7	4.0	4.1
42.0							4.6	4.0	3.3	3.4
44.0								3.4	2.7	2.8
46.0								2.9	2.1	2.2
48.0								2.5	1.6	1.7

  25t DIN / ISO / EN										
→ m	15.0 m	20.1 m	25.1 m	30.2 m	35.3 m	40.4 m	45.4 m	50.5 m	55.6 m	60.0 m
3.0	200.0	170.0	162.0							
3.5	200.0	170.0	162.0							
4.0	188.2	170.0	162.0	139.0						
4.5	173.1	170.0	162.0	139.0						
5.0	158.5	158.1	144.9	131.4	117.8					
6.0	134.4	122.1	112.2	103.7	95.1	84.2				
7.0	105.9	95.4	89.4	84.9	77.7	71.4	68.0			
8.0	83.8	80.6	76.0	70.6	64.6	59.3	57.2	54.0		
9.0	67.8	67.3	63.7	59.4	54.6	50.3	50.6	48.1	44.7	
10.0	56.4	57.0	54.4	51.0	47.0	45.4	44.8	42.1	39.2	37.8
11.0	47.3	49.1	47.2	44.4	40.9	42.1	39.5	37.3	34.7	33.5
12.0	39.8	41.6	41.8	40.8	36.5	37.4	35.2	33.2	30.9	30.0
14.0		31.2	32.2	32.8	31.4	30.3	28.6	27.0	25.0	24.3
16.0		24.4	25.2	26.1	25.9	25.1	23.7	22.3	20.6	20.1
18.0		19.8	20.4	21.2	21.1	21.2	19.9	18.7	17.2	16.8
20.0			16.8	17.5	17.4	17.6	16.9	15.9	14.5	14.2
22.0			14.1	14.7	14.5	14.7	14.2	13.5	12.2	12.0
24.0				12.5	12.3	12.4	11.9	11.5	10.4	10.2
26.0				10.7	10.5	10.6	10.1	9.6	8.8	8.6
28.0				9.4	9.0	9.1	8.5	8.1	7.4	7.3
30.0					7.8	7.8	7.2	6.8	6.1	6.2
32.0					6.8	6.7	6.1	5.7	5.0	5.1
34.0						5.8	5.2	4.7	4.0	4.1
36.0						5.0	4.4	3.9	3.2	3.3
38.0						4.4	3.7	3.2	2.4	2.5
40.0							3.0	2.5	1.8	1.8
42.0							2.5	1.9		

Tragfähigkeiten
Lifting capacities
Capacités de levage
Capacidades de elevación

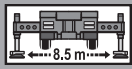
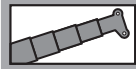

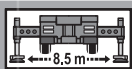
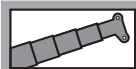

16.5t
DIN / ISO / EN

 m	15.0 m	20.1 m	25.1 m	30.2 m	35.3 m	40.4 m	45.4 m	50.5 m	55.6 m	60.0 m
3.0	200.0	170.0	162.0							
3.5	200.0	170.0	162.0							
4.0	185.2	170.0	162.0	139.0						
4.5	168.8	168.4	148.7	132.5						
5.0	154.1	143.9	128.5	114.2	104.3					
6.0	118.9	105.0	97.5	90.5	81.7	73.4				
7.0	90.9	84.9	78.8	72.0	64.9	58.9	57.4			
8.0	71.8	67.8	63.5	58.7	53.3	52.9	49.6	46.1		
9.0	58.2	55.7	53.2	51.1	45.7	45.6	42.5	39.6	36.6	
10.0	47.0	46.9	45.2	43.8	41.4	39.5	36.9	34.5	31.9	30.7
11.0	38.5	40.2	39.1	38.1	36.2	34.6	32.4	30.4	28.0	27.1
12.0	32.2	34.0	34.2	33.6	31.9	30.7	28.7	26.9	24.8	24.0
14.0		25.1	26.1	26.7	25.5	24.6	23.0	21.6	19.8	19.2
16.0		19.4	20.2	21.1	20.9	20.2	18.8	17.6	16.0	15.6
18.0		15.5	16.1	16.9	16.8	16.8	15.6	14.5	13.0	12.7
20.0			13.0	13.7	13.6	13.9	13.0	12.0	10.6	10.3
22.0			10.8	11.4	11.2	11.4	10.9	9.9	8.6	8.4
24.0				9.4	9.2	9.4	8.9	8.2	7.0	6.8
26.0				7.9	7.6	7.7	7.2	6.7	5.6	5.5
28.0				6.8	6.3	6.4	5.9	5.4	4.5	4.4
30.0					5.3	5.3	4.7	4.3	3.5	3.4
32.0					4.4	4.3	3.8	3.3	2.6	2.5
34.0						3.5	3.0	2.5		
36.0						2.9	2.3	1.8		
38.0						2.4	1.7			



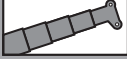
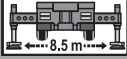

7.5t
DIN / ISO / EN

 m	15.0 m	20.1 m	25.1 m	30.2 m	35.3 m	40.4 m	45.4 m	50.5 m	55.6 m	60.0 m
3.0	200.0	170.0	162.0							
3.5	199.3	170.0	162.0							
4.0	180.9	170.0	162.0	139.0						
4.5	163.8	146.8	128.4	115.3						
5.0	141.1	120.3	108.6	98.5	86.6					
6.0	99.1	90.8	82.0	73.4	65.0	63.3				
7.0	73.1	68.0	63.3	59.5	54.8	51.2	46.9			
8.0	56.4	53.6	50.8	48.4	45.1	42.5	39.2	36.2		
9.0	45.2	43.7	42.0	40.5	38.0	36.0	33.3	30.9	28.1	
10.0	36.4	36.5	35.4	34.5	32.5	31.0	28.7	26.6	24.3	23.3
11.0	29.4	31.1	30.4	29.8	28.2	27.0	25.0	23.2	20.9	20.0
12.0	24.3	26.1	26.4	26.1	24.7	23.7	21.8	20.1	18.0	17.4
14.0		18.9	19.9	20.1	19.0	18.3	16.8	15.4	13.7	13.2
16.0		13.9	14.8	15.7	15.0	14.4	13.2	12.0	10.5	10.2
18.0		10.5	11.2	12.0	11.9	11.6	10.5	9.4	8.1	7.8
20.0			8.6	9.4	9.2	9.3	8.3	7.4	6.1	5.9
22.0			6.7	7.3	7.2	7.4	6.6	5.8	4.6	4.4
24.0				5.8	5.6	5.8	5.3	4.4	3.3	
26.0				4.6	4.4	4.5	3.9	3.3		
28.0				3.8	3.3	3.4	2.9			
30.0					2.5	2.5	2.0			
32.0					1.9	1.8				

Tragfähigkeiten
Lifting capacities
Capacités de levage
Capacidades de elevación

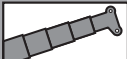
    DIN / ISO / EN										
→ m	15.0 m	20.1 m	25.1 m	30.2 m	35.3 m	40.4 m	45.4 m	50.5 m	55.6 m	60.0 m
3.0	200.0	170.0	162.0							
3.5	195.4	170.0	162.0							
4.0	175.4	170.0	162.0	139.0						
4.5	150.6	124.7	112.7	98.4						
5.0	119.8	106.1	93.8	81.2	69.8					
6.0	80.8	73.4	66.9	61.7	55.9	51.4				
7.0	58.0	54.4	51.0	48.0	44.2	41.1	37.4			
8.0	44.2	42.5	40.5	38.8	36.1	33.9	31.0	28.0		
9.0	35.0	34.4	33.2	32.2	30.0	28.1	25.5	23.1	20.4	
10.0	28.0	28.0	27.3	26.7	24.8	23.5	21.3	19.3	17.0	16.2
11.0	22.1	22.9	22.6	22.4	20.9	19.9	18.0	16.3	14.2	13.6
12.0	17.3	19.0	19.0	19.0	17.8	17.0	15.4	13.8	12.0	11.5
14.0		12.9	13.9	14.1	13.3	12.7	11.4	10.1	8.6	8.2
16.0		8.9	9.8	10.7	10.1	9.6	8.5	7.5	6.1	5.8
18.0		6.3	7.0	7.9	7.7	7.4	6.4	5.4		
20.0			5.0	5.8	5.7	5.6	4.7	3.8		
22.0			3.6	4.2	4.0	4.2	3.4			
24.0				3.0	2.8	2.9				
26.0				2.0	1.8	1.9				

MB

    DIN / ISO / EN										
→ m	15.0 m	20.1 m	25.1 m	30.2 m	35.3 m	40.4 m	45.4 m	50.5 m	55.6 m	60.0 m
3.0	200.0	170.0	162.0							
3.5	190.9	170.0	162.0							
4.0	171.1	170.0	162.0	139.0						
4.5	136.7	114.0	97.8	83.7						
5.0	104.2	91.0	80.1	72.6	64.7					
6.0	69.0	63.4	58.3	54.1	49.2	45.4				
7.0	50.2	47.6	44.8	42.5	39.2	36.5	33.3			
8.0	38.6	37.4	35.9	34.5	32.1	30.2	27.6	25.2		
9.0	30.7	30.3	29.5	28.7	26.9	25.4	23.3	21.3	19.0	
10.0	24.5	25.1	24.7	24.3	22.8	21.7	19.9	18.2	16.2	15.5
11.0	19.4	21.1	21.0	20.8	19.6	18.7	17.1	15.6	13.8	13.3
12.0	15.7	17.6	18.0	18.0	17.0	16.2	14.8	13.5	11.8	11.4
14.0		12.2	13.2	13.8	13.0	12.5	11.3	10.1	8.6	8.2
16.0		8.7	9.6	10.4	10.1	9.6	8.5	7.5	6.1	5.8
18.0		6.3	7.0	7.8	7.7	7.4	6.4	5.4		
20.0			5.0	5.7	5.6	5.6	4.7	3.8		
22.0			3.6	4.2	4.0	4.2	3.4			
24.0				3.0	2.8	2.9				
26.0				2.0	1.8	1.9				

Hubhöhen
 Lifting heights
 Hauteurs de levage
 Alturas de elevación

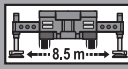
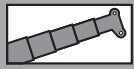

DIN / ISO / EN

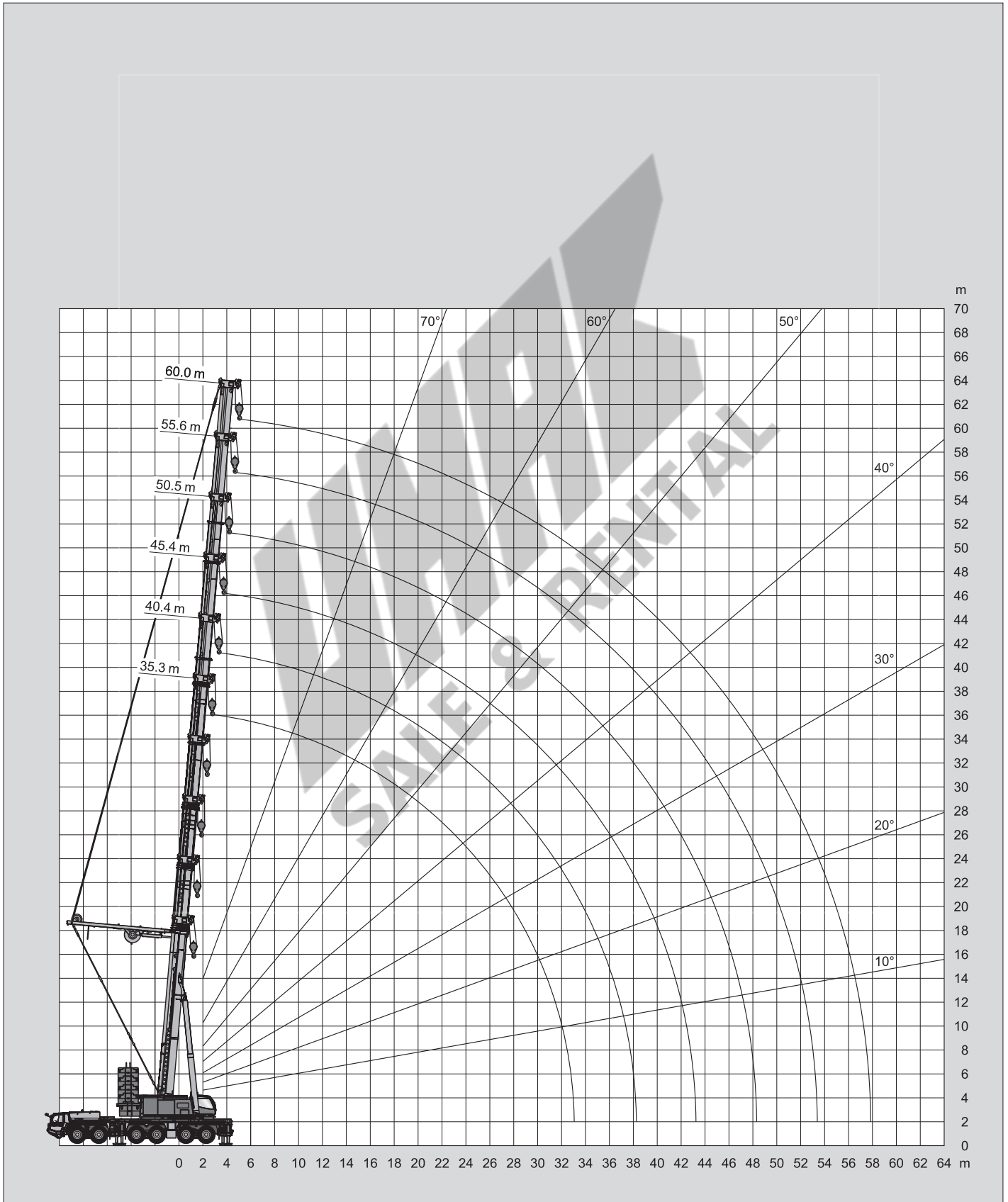

Tragfähigkeiten
Lifting capacities
Capacités de levage
Capacidades de elevación

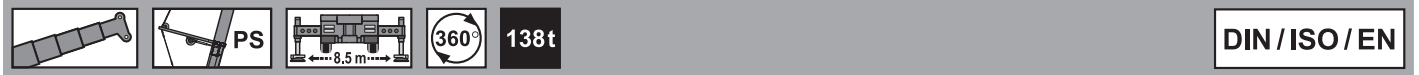

→ m	35.3 m	40.4 m	45.4 m	50.5 m	55.6 m	60.0 m
6.0	118.0	84.2				
7.0	112.6	84.2	68.0			
8.0	101.4	84.2	68.0	58.0		
9.0	93.8	84.2	68.0	58.0	45.0	
10.0	86.3	82.4	68.0	58.0	45.0	34.9
11.0	79.6	76.8	68.0	58.0	45.0	34.8
12.0	74.6	71.2	68.0	58.0	44.8	34.6
14.0	65.3	62.8	59.9	58.0	44.4	34.2
16.0	58.1	55.6	53.7	51.6	44.0	33.8
18.0	52.4	50.3	48.0	46.8	43.7	33.4
20.0	47.6	45.6	43.9	42.5	41.3	33.0
22.0	43.5	41.6	40.0	39.0	37.7	32.7
24.0	39.4	38.4	36.9	35.8	34.8	32.4
26.0	34.9	35.5	34.1	33.2	32.3	31.3
28.0	30.5	33.0	31.6	30.8	30.0	29.1
30.0	25.6	29.8	29.5	28.9	28.1	27.1
32.0	19.2	26.4	27.6	27.1	26.3	25.5
34.0		22.7	25.6	25.4	24.8	23.8
36.0		18.4	22.9	24.0	23.4	22.6
38.0		11.3	20.1	22.6	22.1	21.3
40.0			16.9	20.5	21.0	20.3
42.0			12.6	18.3	19.9	19.2
44.0				15.9	18.5	18.3
46.0				12.9	16.6	17.3
48.0				8.3	14.7	16.0
50.0					12.4	14.5
52.0					9.5	12.8
54.0						10.8
56.0						8.4
58.0						3.7

MB + PS

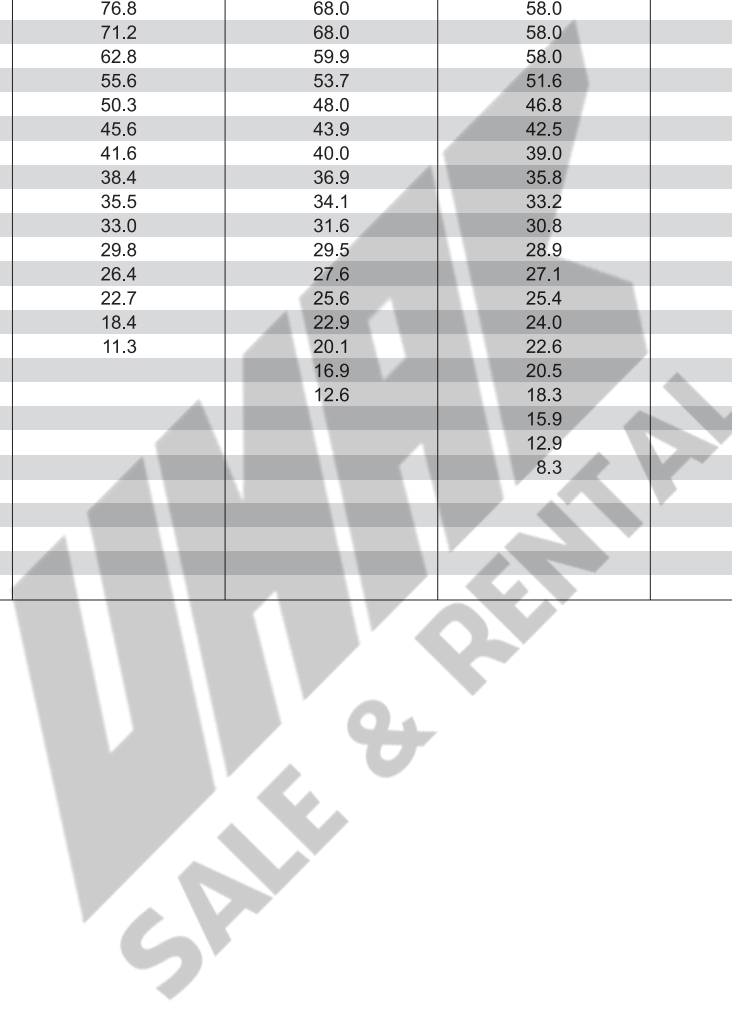



Tragfähigkeiten
Lifting capacities
Capacités de levage
Capacidades de elevación

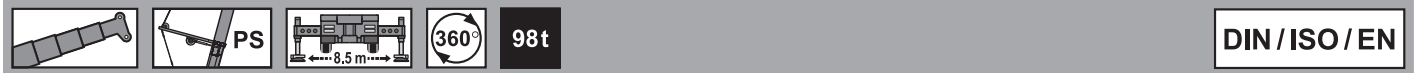

→ m	35.3 m	40.4 m	45.4 m	50.5 m	55.6 m	60.0 m
4.0	118.0					
4.5	118.0					
5.0	118.0					
6.0	118.0	84.2				
7.0	112.6	84.2	68.0			
8.0	101.4	84.2	68.0	58.0		
9.0	93.8	84.2	68.0	58.0	45.0	
10.0	86.3	82.4	68.0	58.0	45.0	34.9
11.0	79.6	76.8	68.0	58.0	45.0	34.8
12.0	74.6	71.2	68.0	58.0	44.8	34.6
14.0	65.3	62.8	59.9	58.0	44.4	34.2
16.0	58.1	55.6	53.7	51.6	44.0	33.8
18.0	52.4	50.3	48.0	46.8	43.7	33.4
20.0	47.6	45.6	43.9	42.5	41.3	33.0
22.0	41.9	41.6	40.0	39.0	37.7	32.7
24.0	36.6	37.9	36.9	35.8	34.8	32.4
26.0	32.2	33.5	34.1	33.2	32.3	31.3
28.0	28.4	29.7	30.5	30.8	30.0	29.1
30.0	25.2	26.4	27.2	28.3	28.1	27.1
32.0	19.2	23.6	24.4	25.4	26.3	25.5
34.0		21.2	22.0	23.0	23.8	23.8
36.0		18.4	19.8	20.8	21.6	21.7
38.0		11.3	17.9	18.9	19.7	19.8
40.0			16.3	17.2	18.0	18.1
42.0			12.6	15.7	16.5	16.6
44.0				14.4	15.1	15.2
46.0				12.9	13.9	14.0
48.0				8.3	12.8	12.9
50.0					11.8	11.8
52.0					9.5	10.9
54.0						10.1
56.0						8.4
58.0						3.7

Tragfähigkeiten
Lifting capacities
Capacités de levage
Capacidades de elevación



 m	35.3 m	40.4 m	45.4 m	50.5 m	55.6 m	60.0 m
4.0	118.0					
4.5	118.0					
5.0	118.0					
6.0	118.0	84.2				
7.0	112.6	84.2	68.0			
8.0	101.4	84.2	68.0	58.0		
9.0	93.8	84.2	68.0	58.0	45.0	
10.0	86.3	82.4	68.0	58.0	45.0	34.9
11.0	79.6	76.8	68.0	58.0	45.0	34.8
12.0	74.6	71.2	68.0	58.0	44.8	34.6
14.0	65.3	62.8	59.9	58.0	44.4	34.2
16.0	58.1	55.6	53.7	51.6	44.0	33.8
18.0	48.6	49.9	48.0	46.8	43.7	33.4
20.0	41.2	42.5	43.3	42.5	41.3	33.0
22.0	35.3	36.7	37.5	38.5	37.7	32.7
24.0	30.4	31.8	32.6	33.7	34.5	32.4
26.0	26.4	27.7	28.6	29.6	30.5	30.6
28.0	23.0	24.3	25.2	26.2	27.1	27.1
30.0	20.2	21.4	22.3	23.3	24.1	24.2
32.0	17.8	19.0	19.8	20.8	21.7	21.7
34.0		16.8	17.7	18.7	19.5	19.6
36.0		15.0	15.8	16.8	17.6	17.7
38.0		11.3	14.1	15.1	15.9	16.0
40.0			12.7	13.6	14.4	14.5
42.0			11.4	12.3	13.1	13.2
44.0				11.1	11.9	12.0
46.0				10.1	10.8	10.9
48.0				8.3	9.8	9.9
50.0					8.9	9.0
52.0					8.1	8.2
54.0						7.5
56.0						6.8
58.0						3.7

MB + PS

Hubhöhen
Lifting heights
Hauteurs de levage
Alturas de elevación

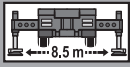
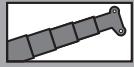

138t

DIN/ISO/EN

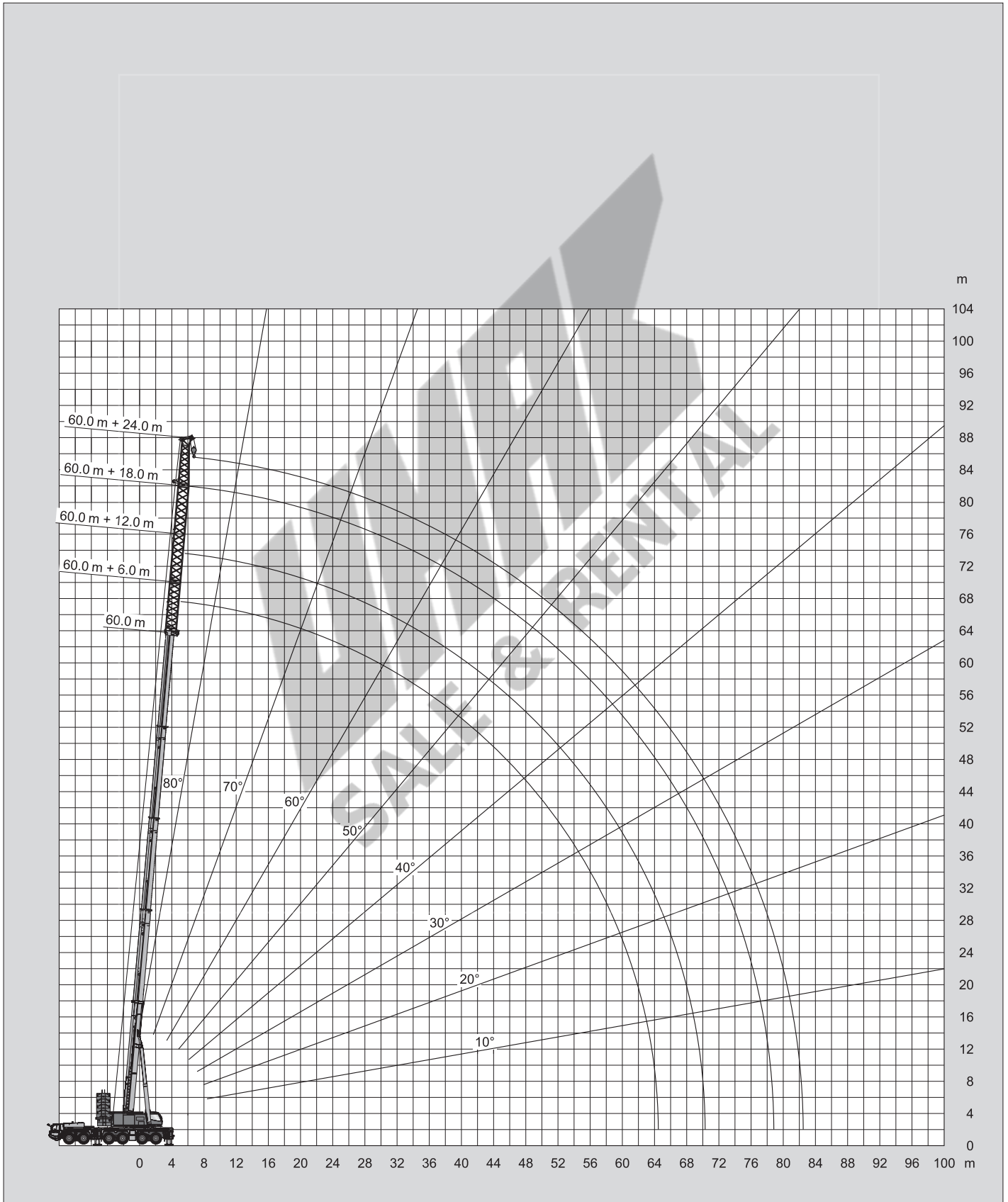

Tragfähigkeiten
Lifting capacities
Capacités de levage
Capacidades de elevación



DIN / ISO / EN

m	LFJ 6.0 m					LFJ 12.0 m					LFJ 18.0 m					LFJ 24.0 m				
	40.4 m	45.4 m	50.5 m	55.6 m	60.0 m	40.4 m	45.4 m	50.5 m	55.6 m	60.0 m	40.4 m	45.4 m	50.5 m	55.6 m	60.0 m	40.4 m	45.4 m	50.5 m	55.6 m	60.0 m
7.0	54.2																			
8.0	50.7	43.2																		
9.0	47.6	40.8	32.2			43.5														
10.0	44.9	38.6	30.5	26.8		41.0	34.9	27.5			34.3									
11.0	42.5	36.8	29.0	25.5	24.2	38.8	33.1	26.1			32.8	30.2				24.6				
12.0	40.4	35.1	27.6	24.2	23.0	36.8	31.5	24.8	22.1		31.4	28.7	22.9			23.8	22.6			
14.0	36.8	32.2	25.2	22.1	21.0	33.4	28.8	22.6	20.3	19.1	29.0	26.2	20.9	18.2	17.3	22.2	21.4	18.8		
16.0	33.8	29.7	23.3	20.4	19.3	30.6	26.5	20.8	18.7	17.6	26.9	24.1	19.2	16.8	16.0	20.8	20.2	17.3	15.2	13.9
18.0	31.3	27.5	21.7	18.9	18.0	28.2	24.6	19.3	17.3	16.3	25.0	22.3	17.8	15.7	14.9	19.5	19.1	16.1	14.1	13.4
20.0	29.2	25.5	20.3	17.7	16.8	26.2	23.0	18.0	16.1	15.2	23.4	20.8	16.5	14.6	13.9	18.2	18.1	15.0	13.1	12.5
22.0	27.4	23.9	19.1	16.6	15.7	24.5	21.6	16.8	15.0	14.2	22.0	19.5	15.4	13.7	13.1	17.1	17.0	14.1	12.3	11.7
24.0	25.8	22.4	18.0	15.6	14.8	23.0	20.4	15.9	14.1	13.3	20.7	18.3	14.5	12.9	12.3	16.1	16.1	13.2	11.6	11.0
26.0	24.4	21.2	17.1	14.8	14.0	21.7	19.3	15.0	13.3	12.6	19.6	17.3	13.6	12.2	11.5	15.2	15.3	12.4	10.9	10.4
28.0	22.9	20.0	16.2	14.0	13.3	20.5	18.2	14.2	12.6	11.9	18.6	16.4	12.9	11.5	10.9	14.4	14.5	11.7	10.3	9.9
30.0	21.5	19.0	15.5	13.4	12.6	19.5	17.3	13.5	12.0	11.3	17.6	15.6	12.2	10.9	10.3	13.6	13.8	11.0	9.8	9.4
32.0	20.3	18.2	14.8	12.8	12.1	18.6	16.4	12.9	11.4	10.7	16.8	14.8	11.6	10.3	9.8	13.0	13.2	10.5	9.3	8.9
34.0	19.2	17.3	14.3	12.2	11.5	17.7	15.6	12.3	10.9	10.2	16.1	14.2	11.1	9.8	9.3	12.3	12.6	9.9	8.9	8.4
36.0	18.2	16.6	13.7	11.7	11.1	17.0	14.9	11.8	10.4	9.8	15.4	13.6	10.6	9.4	8.9	11.8	12.0	9.5	8.4	8.0
38.0	17.3	16.0	13.2	11.3	10.6	16.3	14.3	11.3	9.9	9.4	14.7	13.0	10.1	8.9	8.5	11.3	11.5	9.0	8.0	7.6
40.0	16.5	15.4	12.8	10.9	10.2	15.7	13.7	10.9	9.5	9.0	14.1	12.5	9.7	8.6	8.1	10.8	11.1	8.6	7.7	7.3
42.0	15.8	14.8	12.4	10.5	9.9	15.0	13.2	10.5	9.2	8.6	13.6	12.0	9.3	8.2	7.8	10.4	10.7	8.3	7.3	6.9
44.0	10.9	14.1	12.1	10.2	9.5	14.3	12.7	10.2	8.8	8.3	13.1	11.5	9.0	7.9	7.5	10.0	10.3	7.9	7.0	6.6
46.0		13.6	11.8	9.8	9.2	13.7	12.3	9.8	8.5	8.0	12.6	11.1	8.7	7.6	7.2	9.6	9.9	7.6	6.7	6.4
48.0		11.6	11.5	9.6	9.0	12.9	11.9	9.6	8.3	7.7	12.2	10.7	8.4	7.3	6.9	9.3	9.6	7.3	6.5	6.0
50.0			11.3	9.3	8.7	8.7	11.6	9.3	8.0	7.5	11.9	10.3	8.1	7.1	6.7	9.0	9.3	7.1	6.2	5.7
54.0			7.8	9.0	8.3		9.3	8.9	7.5	7.0	10.5	9.7	7.6	6.6	6.0	8.4	8.7	6.6	5.8	5.0
58.0				8.6	7.4			8.6	7.2	6.3		9.2	7.2	6.2	5.4	8.0	8.2	6.2	5.4	4.4
62.0					6.5				6.9	5.7			7.0	5.9	4.8	5.1	7.8	5.9	5.0	3.9
66.0										5.2			5.0	5.6	4.4		5.8	5.6	4.7	3.5
70.0														5.5	4.0			5.4	4.3	3.1
74.0															3.7				4.1	2.8
78.0																				2.5

MB+LFJ

Tragfähigkeiten
Lifting capacities
Capacités de levage
Capacidades de elevación

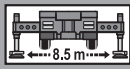
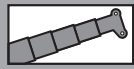
118t
DIN / ISO / EN

m	LFJ 6.0 m					LFJ 12.0 m					LFJ 18.0 m					LFJ 24.0 m				
	40.4 m	45.4 m	50.5 m	55.6 m	60.0 m	40.4 m	45.4 m	50.5 m	55.6 m	60.0 m	40.4 m	45.4 m	50.5 m	55.6 m	60.0 m	40.4 m	45.4 m	50.5 m	55.6 m	60.0 m
7.0	54.2																			
8.0	50.7	43.2																		
9.0	47.6	40.8	32.2			43.5														
10.0	44.9	38.6	30.5	26.8		41.0	34.9	27.5			34.3									
11.0	42.5	36.8	29.0	25.5	24.2	38.8	33.1	26.1			32.8	30.2			24.6					
12.0	40.4	35.1	27.6	24.2	23.0	36.8	31.5	24.8	22.1		31.4	28.7	22.9		23.8	22.6				
14.0	36.8	32.2	25.2	22.1	21.0	33.4	28.8	22.6	20.3	19.1	29.0	26.2	20.9	18.2	17.3	22.2	21.4	18.8		
16.0	33.8	29.7	23.3	20.4	19.3	30.6	26.5	20.8	18.7	17.6	26.9	24.1	19.2	16.8	16.0	20.8	20.2	17.3	15.2	13.9
18.0	31.3	27.5	21.7	18.9	18.0	28.2	24.6	19.3	17.3	16.3	25.0	22.3	17.8	15.7	14.9	19.5	19.1	16.1	14.1	13.4
20.0	29.2	25.5	20.3	17.7	16.8	26.2	23.0	18.0	16.1	15.2	23.4	20.8	16.5	14.6	13.9	18.2	18.1	15.0	13.1	12.5
22.0	27.4	23.9	19.1	16.6	15.7	24.5	21.6	16.8	15.0	14.2	22.0	19.5	15.4	13.7	13.1	17.1	17.0	14.1	12.3	11.7
24.0	25.8	22.4	18.0	15.6	14.8	23.0	20.4	15.9	14.1	13.3	20.7	18.3	14.5	12.9	12.3	16.1	16.1	13.2	11.6	11.0
26.0	24.4	21.2	17.1	14.8	14.0	21.7	19.3	15.0	13.3	12.6	19.6	17.3	13.6	12.2	11.5	15.2	15.3	12.4	10.9	10.4
28.0	22.9	20.0	16.2	14.0	13.3	20.5	18.2	14.2	12.6	11.9	18.6	16.4	12.9	11.5	10.9	14.4	14.5	11.7	10.3	9.9
30.0	21.5	19.0	15.5	13.4	12.6	19.5	17.3	13.5	12.0	11.3	17.6	15.6	12.2	10.9	10.3	13.6	13.8	11.0	9.8	9.4
32.0	20.3	18.2	14.8	12.8	12.1	18.6	16.4	12.9	11.4	10.7	16.8	14.8	11.6	10.3	9.8	13.0	13.2	10.5	9.3	8.9
34.0	19.2	17.3	14.3	12.2	11.5	17.7	15.6	12.3	10.9	10.2	16.1	14.2	11.1	9.8	9.3	12.3	12.6	9.9	8.9	8.4
36.0	18.2	16.6	13.7	11.7	11.1	17.0	14.9	11.8	10.4	9.8	15.4	13.6	10.6	9.4	8.9	11.8	12.0	9.5	8.4	8.0
38.0	17.3	16.0	13.2	11.3	10.6	16.3	14.3	11.3	9.9	9.4	14.7	13.0	10.1	8.9	8.5	11.3	11.5	9.0	8.0	7.6
40.0	16.5	15.4	12.8	10.9	10.2	15.7	13.7	10.9	9.5	9.0	14.1	12.5	9.7	8.6	8.1	10.8	11.1	8.6	7.7	7.3
42.0	15.8	14.8	12.4	10.5	9.9	15.0	13.2	10.5	9.2	8.6	13.6	12.0	9.3	8.2	7.8	10.4	10.7	8.3	7.3	6.9
44.0	10.9	14.1	12.1	10.2	9.5	14.3	12.7	10.2	8.8	8.3	13.1	11.5	9.0	7.9	7.5	10.0	10.3	7.9	7.0	6.6
46.0		13.6	11.8	9.8	9.2	13.7	12.3	9.8	8.5	8.0	12.6	11.1	8.7	7.6	7.2	9.6	9.9	7.6	6.7	6.4
48.0		11.6	11.5	9.6	9.0	12.9	11.9	9.6	8.3	7.7	12.2	10.7	8.4	7.3	6.9	9.3	9.6	7.3	6.5	6.0
50.0			11.3	9.3	8.7	8.7	11.6	9.3	8.0	7.5	11.9	10.3	8.1	7.1	6.7	9.0	9.3	7.1	6.2	5.7
54.0			7.8	9.0	8.3		9.3	8.9	7.5	7.0	10.5	9.7	7.6	6.6	6.0	8.4	8.7	6.6	5.8	5.0
58.0				8.6	7.4			8.6	7.2	6.3		9.2	7.2	6.2	5.4	8.0	8.2	6.2	5.4	4.4
62.0					6.5				6.9	5.7			7.0	5.9	4.8	5.1	7.8	5.9	5.0	3.9
66.0										5.2			5.0	5.6	4.4		5.8	5.6	4.7	3.5
70.0														5.5	4.0			5.4	4.3	3.1
74.0															3.7				4.1	2.8
78.0																				2.5

Tragfähigkeiten
Lifting capacities
Capacités de levage
Capacidades de elevación



DIN / ISO / EN

m	LFJ 6.0 m					LFJ 12.0 m					LFJ 18.0 m					LFJ 24.0 m						
	40.4 m	45.4 m	50.5 m	55.6 m	60.0 m	40.4 m	45.4 m	50.5 m	55.6 m	60.0 m	40.4 m	45.4 m	50.5 m	55.6 m	60.0 m	40.4 m	45.4 m	50.5 m	55.6 m	60.0 m		
7.0	54.2																					
8.0	50.7	43.2																				
9.0	47.6	40.8	32.2			43.5																
10.0	44.9	38.6	30.5	26.8		41.0	34.9	27.5			34.3											
11.0	42.5	36.8	29.0	25.5	24.2	38.8	33.1	26.1			32.8	30.2				24.6						
12.0	40.4	35.1	27.6	24.2	23.0	36.8	31.5	24.8	22.1		31.4	28.7	22.9			23.8	22.6					
14.0	36.8	32.2	25.2	22.1	21.0	33.4	28.8	22.6	20.3	19.1	29.0	26.2	20.9	18.2	17.3	22.2	21.4	18.8				
16.0	33.8	29.7	23.3	20.4	19.3	30.6	26.5	20.8	18.7	17.6	26.9	24.1	19.2	16.8	16.0	20.8	20.2	17.3	15.2	13.9		
18.0	31.3	27.5	21.7	18.9	18.0	28.2	24.6	19.3	17.3	16.3	25.0	22.3	17.8	15.7	14.9	19.5	19.1	16.1	14.1	13.4		
20.0	29.2	25.5	20.3	17.7	16.8	26.2	23.0	18.0	16.1	15.2	23.4	20.8	16.5	14.6	13.9	18.2	18.1	15.0	13.1	12.5		
22.0	27.4	23.9	19.1	16.6	15.7	24.5	21.6	16.8	15.0	14.2	22.0	19.5	15.4	13.7	13.1	17.1	17.0	14.1	12.3	11.7		
24.0	25.8	22.4	18.0	15.6	14.8	23.0	20.4	15.9	14.1	13.3	20.7	18.3	14.5	12.9	12.3	16.1	16.1	13.2	11.6	11.0		
26.0	23.2	21.2	17.1	14.8	14.0	21.7	19.3	15.0	13.3	12.6	19.6	17.3	13.6	12.2	11.5	15.2	15.3	12.4	10.9	10.4		
28.0	20.4	20.0	16.2	14.0	13.3	20.5	18.2	14.2	12.6	11.9	18.6	16.4	12.9	11.5	10.9	14.4	14.5	11.7	10.3	9.9		
30.0	18.1	18.5	15.5	13.4	12.6	18.7	17.3	13.5	12.0	11.3	17.6	15.6	12.2	10.9	10.3	13.6	13.8	11.0	9.8	9.4		
32.0	16.1	16.4	14.8	12.8	12.1	16.6	16.4	12.9	11.4	10.7	16.8	14.8	11.6	10.3	9.8	13.0	13.2	10.5	9.3	8.9		
34.0	14.3	14.7	14.3	12.2	11.5	14.9	15.1	12.3	10.9	10.2	15.5	14.2	11.1	9.8	9.3	12.3	12.6	9.9	8.9	8.4		
36.0	12.7	13.1	13.7	11.7	11.1	13.3	13.6	11.8	10.4	9.8	13.9	13.6	10.6	9.4	8.9	11.8	12.0	9.5	8.4	8.0		
38.0	11.4	11.7	12.4	11.3	10.6	11.9	12.2	11.3	9.9	9.4	12.5	12.6	10.1	8.9	8.5	11.3	11.5	9.0	8.0	7.6		
40.0	10.2	10.5	11.1	10.9	10.2	10.7	10.9	10.9	9.5	9.0	11.3	11.3	9.7	8.6	8.1	10.8	11.1	8.6	7.7	7.3		
42.0	9.2	9.5	10.0	10.5	9.9	9.6	9.8	10.2	9.2	8.6	10.2	10.2	9.3	8.2	7.8	10.4	10.4	8.3	7.3	6.9		
44.0	8.3	8.5	9.1	9.5	9.5	8.7	8.9	9.2	8.8	8.3	9.2	9.2	9.0	7.9	7.5	9.4	9.4	7.9	7.0	6.6		
46.0		7.6	8.2	8.6	8.6	7.8	8.0	8.3	8.5	8.0	8.3	8.3	8.7	7.6	7.2	8.5	8.5	7.6	6.7	6.4		
48.0		6.9	7.4	7.8	7.8	7.0	7.2	7.5	8.0	7.7	7.5	7.5	7.9	7.3	6.9	7.7	7.7	7.3	6.5	6.0		
50.0			6.7	7.1	7.1	6.4	6.5	6.8	7.2	7.1	6.8	6.8	7.2	7.1	6.7	7.0	6.9	7.1	6.2	5.7		
54.0			5.5	5.8	5.8		5.2	5.5	5.9	5.8	5.5	5.5	5.8	6.1	5.9	5.7	5.6	5.8	5.8	5.0		
58.0				4.8	4.7			4.5	4.8	4.7			4.4	4.7	5.0	4.8	4.6	4.5	4.7	4.9	4.4	
62.0					3.8					3.9	3.7			3.8	4.0	3.9	3.7	3.6	3.8	3.9	3.7	
66.0											2.9			3.0	3.2	3.0		2.8	2.9	3.1	2.9	
70.0														2.5	2.3				2.3	2.4	2.2	
74.0															1.7				1.8	1.5		

MB+LFJ

Tragfähigkeiten
Lifting capacities
Capacités de levage
Capacidades de elevación

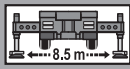
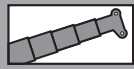
58t
DIN / ISO / EN

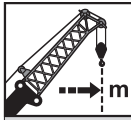
 m	LFJ 6.0 m					LFJ 12.0 m					LFJ 18.0 m					LFJ 24.0 m				
	40.4 m	45.4 m	50.5 m	55.6 m	60.0 m	40.4 m	45.4 m	50.5 m	55.6 m	60.0 m	40.4 m	45.4 m	50.5 m	55.6 m	60.0 m	40.4 m	45.4 m	50.5 m	55.6 m	60.0 m
7.0	54.2																			
8.0	50.7	43.2																		
9.0	47.6	40.8	32.2			43.5														
10.0	44.9	38.6	30.5	26.8		41.0	34.9	27.5			34.3									
11.0	42.5	36.8	29.0	25.5	24.2	38.8	33.1	26.1			32.8	30.2			24.6					
12.0	40.4	35.1	27.6	24.2	23.0	36.8	31.5	24.8	22.1		31.4	28.7	22.9		23.8	22.6				
14.0	36.8	32.2	25.2	22.1	21.0	33.4	28.8	22.6	20.3	19.1	29.0	26.2	20.9	18.2	17.3	22.2	21.4	18.8		
16.0	33.8	29.7	23.3	20.4	19.3	30.6	26.5	20.8	18.7	17.6	26.9	24.1	19.2	16.8	16.0	20.8	20.2	17.3	15.2	13.9
18.0	31.3	27.5	21.7	18.9	18.0	28.2	24.6	19.3	17.3	16.3	25.0	22.3	17.8	15.7	14.9	19.5	19.1	16.1	14.1	13.4
20.0	27.1	25.5	20.3	17.7	16.8	26.2	23.0	18.0	16.1	15.2	23.4	20.8	16.5	14.6	13.9	18.2	18.1	15.0	13.1	12.5
22.0	23.3	23.3	19.1	16.6	15.7	23.5	21.6	16.8	15.0	14.2	22.0	19.5	15.4	13.7	13.1	17.1	17.0	14.1	12.3	11.7
24.0	19.8	20.3	18.0	15.6	14.8	20.5	20.3	15.9	14.1	13.3	20.7	18.3	14.5	12.9	12.3	16.1	16.1	13.2	11.6	11.0
26.0	17.0	17.5	17.1	14.8	14.0	17.7	18.0	15.0	13.3	12.6	18.3	17.3	13.6	12.2	11.5	15.2	15.3	12.4	10.9	10.4
28.0	14.7	15.1	15.8	14.0	13.3	15.4	15.7	14.2	12.6	11.9	16.0	16.0	12.9	11.5	10.9	14.4	14.5	11.7	10.3	9.9
30.0	12.7	13.1	13.8	13.4	12.6	13.4	13.7	13.5	12.0	11.3	14.0	14.1	12.2	10.9	10.3	13.6	13.8	11.0	9.8	9.4
32.0	11.1	11.5	12.1	12.6	12.1	11.7	12.0	12.4	11.4	10.7	12.3	12.4	11.6	10.3	9.8	12.7	12.6	10.5	9.3	8.9
34.0	9.6	10.0	10.7	11.1	11.2	10.2	10.5	10.9	10.9	10.2	10.8	10.9	11.1	9.8	9.3	11.2	11.1	9.9	8.9	8.4
36.0	8.4	8.7	9.4	9.8	9.9	8.9	9.2	9.6	10.1	9.8	9.5	9.6	10.0	9.4	8.9	9.8	9.8	9.5	8.4	8.0
38.0	7.3	7.6	8.3	8.7	8.8	7.8	8.1	8.5	8.9	8.8	8.4	8.5	8.9	8.9	8.5	8.7	8.7	8.9	8.0	7.6
40.0	6.3	6.6	7.3	7.7	7.7	6.8	7.1	7.4	7.9	7.8	7.4	7.4	7.9	8.1	7.9	7.7	7.7	7.9	7.7	7.3
42.0	5.5	5.8	6.4	6.8	6.8	5.9	6.2	6.5	7.0	6.9	6.5	6.5	6.9	7.2	7.0	6.8	6.8	7.0	7.1	6.9
44.0	4.8	5.0	5.6	6.0	6.0	5.2	5.4	5.7	6.2	6.1	5.7	5.7	6.1	6.4	6.2	5.9	5.9	6.1	6.3	6.1
46.0		4.3	4.9	5.3	5.3	4.5	4.7	5.0	5.4	5.3	5.0	5.0	5.4	5.6	5.5	5.2	5.2	5.4	5.6	5.4
48.0		3.7	4.2	4.6	4.6	3.9	4.0	4.4	4.8	4.7	4.3	4.4	4.7	5.0	4.8	4.5	4.5	4.7	4.9	4.7
50.0			3.6	4.0	4.0	3.3	3.4	3.8	4.2	4.1	3.7	3.8	4.1	4.4	4.2	3.9	3.9	4.1	4.3	4.1
54.0			2.7	3.0	3.0		2.4	2.7	3.1	3.0	2.7	2.7	3.1	3.3	3.1	2.9	2.8	3.0	3.2	3.0
58.0				2.2	2.1			1.9	2.2	2.1		1.9	2.2	2.4	2.2	2.0	2.0	2.1	2.3	2.1
62.0									1.5					1.6	1.5					1.5



UNIVERSAL
SALE & RENTAL

Hubhöhen
Lifting heights
Hauteurs de levage
Alturas de elevación



DIN/ISO/EN

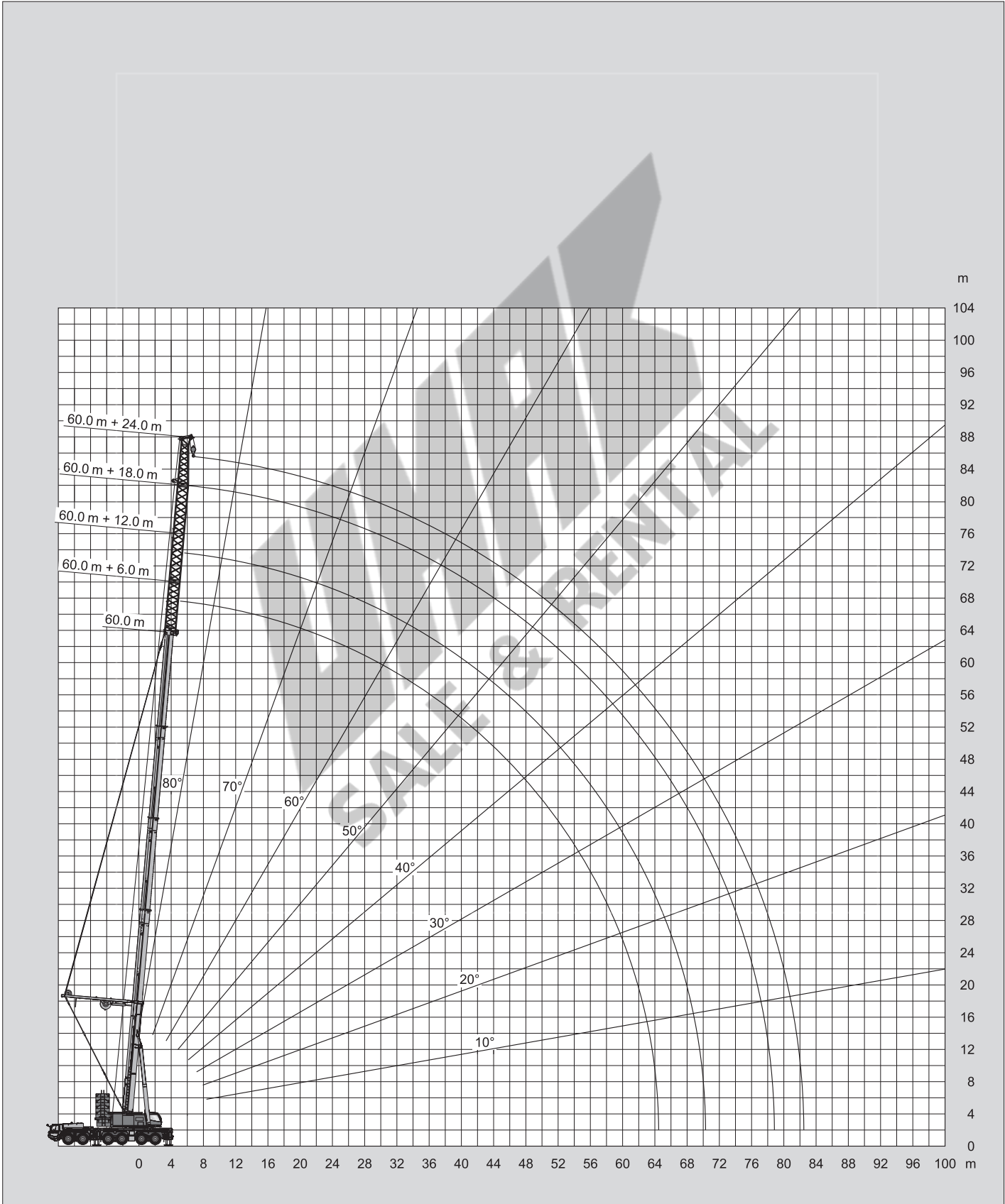

Tragfähigkeiten
Lifting capacities
Capacités de levage
Capacidades de elevación



m	LFJ 6.0 m					LFJ 12.0 m					LFJ 18.0 m					LFJ 24.0 m					
	40.4 m	45.4 m	50.5 m	55.6 m	60.0 m	40.4 m	45.4 m	50.5 m	55.6 m	60.0 m	40.4 m	45.4 m	50.5 m	55.6 m	60.0 m	40.4 m	45.4 m	50.5 m	55.6 m	60.0 m	
7.0	58.6																				
8.0	58.6	51.1																			
9.0	58.6	51.1	39.9			47.4															
10.0	58.6	51.1	38.3	31.8		47.4	38.4	31.2			33.3										
11.0	58.6	51.1	36.8	30.6	28.1	47.4	38.4	31.2			33.3	29.1				23.7					
12.0	58.6	51.1	35.5	29.4	28.0	47.4	38.4	29.9	23.9		33.2	29.1	22.7			23.7	20.9				
14.0	58.5	50.5	33.2	27.3	26.1	45.2	38.4	27.7	23.9	20.9	31.1	29.1	22.7	17.9	15.7	23.0	20.9	16.8			
16.0	51.7	48.3	31.1	25.6	24.4	42.7	38.4	25.8	22.3	20.9	29.1	28.5	22.6	17.9	15.7	21.6	20.9	16.8	13.2	11.5	
18.0	46.1	44.1	29.4	24.0	23.0	40.4	38.3	24.2	20.8	19.9	27.3	27.0	21.0	17.9	15.4	20.4	19.9	16.8	13.2	11.2	
20.0	41.6	39.8	27.9	22.7	21.8	37.1	35.7	22.8	19.5	18.7	25.5	25.7	19.7	17.2	15.0	19.2	19.0	16.8	13.2	10.9	
22.0	37.7	36.1	26.5	21.5	20.6	33.7	32.4	21.5	18.4	17.7	23.9	24.4	18.5	16.1	14.6	18.1	18.0	16.1	13.2	10.6	
24.0	34.5	33.0	25.3	20.4	19.6	30.8	29.6	20.4	17.4	16.7	22.5	23.1	17.5	15.2	14.1	17.2	17.2	15.2	13.2	10.2	
26.0	31.7	30.3	24.2	19.5	18.7	28.3	27.2	19.4	16.5	15.9	21.2	21.9	16.6	14.4	13.7	16.3	16.4	14.3	12.6	9.8	
28.0	29.3	27.9	23.3	18.6	17.9	26.2	25.1	18.5	15.7	15.1	20.0	20.8	15.7	13.6	13.2	15.4	15.7	13.6	11.9	9.4	
30.0	27.1	25.9	22.4	17.8	16.7	24.2	23.2	17.7	15.0	14.4	19.0	19.8	15.0	12.9	12.6	14.6	15.0	12.9	11.3	9.0	
32.0	25.2	24.1	21.6	17.2	15.6	22.5	21.6	17.0	14.3	13.4	18.0	18.8	14.3	12.3	11.9	13.9	14.3	12.3	10.8	8.7	
34.0	23.5	22.5	20.9	16.5	14.6	21.0	20.1	16.3	13.7	12.5	17.2	18.0	13.7	11.8	11.1	13.2	13.7	11.7	10.2	8.3	
36.0	22.0	21.0	20.3	15.9	13.7	19.7	18.8	15.7	13.2	11.7	16.4	17.2	13.1	11.3	10.3	12.6	13.1	11.2	9.8	7.9	
38.0	20.7	19.7	19.3	15.4	12.8	18.5	17.6	15.2	12.7	10.9	15.7	16.1	12.6	10.8	9.6	12.0	12.5	10.7	9.3	7.5	
40.0	17.9	18.5	18.2	14.9	12.1	17.4	16.6	14.7	12.2	10.3	15.0	15.1	12.2	10.4	9.0	11.5	12.0	10.3	8.9	7.1	
42.0	14.4	17.4	17.2	14.5	11.4	16.4	15.6	14.2	11.8	9.7	14.4	14.2	11.7	10.0	8.5	11.0	11.5	9.9	8.6	6.8	
44.0	9.3	16.0	16.2	14.1	10.8	15.4	14.7	13.8	11.4	9.1	13.9	13.4	11.3	9.6	8.0	10.5	11.1	9.5	8.2	6.5	
46.0		13.4	15.3	13.7	10.2	14.3	13.9	13.4	11.0	8.6	13.3	12.6	11.0	9.3	7.5	10.1	10.7	9.2	7.9	6.1	
48.0		10.0	14.5	13.4	9.7	11.4	13.1	12.8	10.7	8.2	12.6	12.0	10.6	9.0	7.1	9.7	10.3	8.9	7.6	5.8	
50.0			12.5	13.1	9.2	7.2	12.4	12.2	10.4	7.7	12.0	11.3	10.3	8.7	6.7	9.4	9.9	8.6	7.4	5.5	
54.0			6.3	11.6	8.3		7.9	11.0	9.9	7.0	9.2	10.2	9.8	8.2	6.0	8.7	9.1	8.0	6.9	5.0	
58.0				7.2	7.4			7.9	9.4	6.3			8.7	9.0	7.7	5.4	8.2	8.2	7.6	6.5	4.4
62.0					6.5				7.8	5.7				8.2	7.4	4.8	3.9	7.4	7.2	6.1	3.9
66.0										5.2					7.1	4.4		4.6	6.5	5.8	3.5
70.0															4.4	4.0			4.9	5.5	3.1
74.0																3.7				4.8	2.8
78.0																					2.5

MB
+ LFJ + PS

Tragfähigkeiten
Lifting capacities
Capacités de levage
Capacidades de elevación



m	LFJ 6.0 m					LFJ 12.0 m					LFJ 18.0 m					LFJ 24.0 m				
	40.4 m	45.4 m	50.5 m	55.6 m	60.0 m	40.4 m	45.4 m	50.5 m	55.6 m	60.0 m	40.4 m	45.4 m	50.5 m	55.6 m	60.0 m	40.4 m	45.4 m	50.5 m	55.6 m	60.0 m
7.0	58.6																			
8.0	58.6	51.1																		
9.0	58.6	51.1	39.9			47.4														
10.0	58.6	51.1	38.3	31.8		47.4	38.4	31.2			33.3									
11.0	58.6	51.1	36.8	30.6	28.1	47.4	38.4	31.2			33.3	29.1				23.7				
12.0	58.6	51.1	35.5	29.4	28.0	47.4	38.4	29.9	23.9		33.2	29.1	22.7			23.7	20.9			
14.0	58.5	50.5	33.2	27.3	26.1	45.2	38.4	27.7	23.9	20.9	31.1	29.1	22.7	17.9	15.7	23.0	20.9	16.8		
16.0	51.7	48.3	31.1	25.6	24.4	42.7	38.4	25.8	22.3	20.9	29.1	28.5	22.6	17.9	15.7	21.6	20.9	16.8	13.2	11.5
18.0	46.1	44.1	29.4	24.0	23.0	40.4	38.3	24.2	20.8	19.9	27.3	27.0	21.0	17.9	15.4	20.4	19.9	16.8	13.2	11.2
20.0	41.6	39.8	27.9	22.7	21.8	37.1	35.7	22.8	19.5	18.7	25.5	25.7	19.7	17.2	15.0	19.2	19.0	16.8	13.2	10.9
22.0	37.7	36.1	26.5	21.5	20.6	33.7	32.4	21.5	18.4	17.7	23.9	24.4	18.5	16.1	14.6	18.1	18.0	16.1	13.2	10.6
24.0	34.5	33.0	25.3	20.4	19.6	30.8	29.6	20.4	17.4	16.7	22.5	23.1	17.5	15.2	14.1	17.2	17.2	15.2	13.2	10.2
26.0	31.7	30.3	24.2	19.5	18.7	28.3	27.2	19.4	16.5	15.9	21.2	21.9	16.6	14.4	13.7	16.3	16.4	14.3	12.6	9.8
28.0	29.3	27.9	23.3	18.6	17.9	26.2	25.1	18.5	15.7	15.1	20.0	20.8	15.7	13.6	13.2	15.4	15.7	13.6	11.9	9.4
30.0	27.1	25.9	22.4	17.8	16.7	24.2	23.2	17.7	15.0	14.4	19.0	19.8	15.0	12.9	12.6	14.6	15.0	12.9	11.3	9.0
32.0	24.6	24.1	21.6	17.2	15.6	22.5	21.6	17.0	14.3	13.4	18.0	18.8	14.3	12.3	11.9	13.9	14.3	12.3	10.8	8.7
34.0	22.2	22.5	20.9	16.5	14.6	21.0	20.1	16.3	13.7	12.5	17.2	18.0	13.7	11.8	11.1	13.2	13.7	11.7	10.2	8.3
36.0	20.0	20.6	20.3	15.9	13.7	19.7	18.8	15.7	13.2	11.7	16.4	17.2	13.1	11.3	10.3	12.6	13.1	11.2	9.8	7.9
38.0	18.1	18.7	19.3	15.4	12.8	18.5	17.6	15.2	12.7	10.9	15.7	16.1	12.6	10.8	9.6	12.0	12.5	10.7	9.3	7.5
40.0	16.5	17.0	17.7	14.9	12.1	17.3	16.6	14.7	12.2	10.3	15.0	15.1	12.2	10.4	9.0	11.5	12.0	10.3	8.9	7.1
42.0	14.4	15.5	16.2	14.5	11.4	15.7	15.6	14.2	11.8	9.7	14.4	14.2	11.7	10.0	8.5	11.0	11.5	9.9	8.6	6.8
44.0	9.3	14.1	14.8	14.1	10.8	14.4	14.7	13.8	11.4	9.1	13.9	13.4	11.3	9.6	8.0	10.5	11.1	9.5	8.2	6.5
46.0		12.9	13.6	13.7	10.2	13.1	13.5	13.4	11.0	8.6	13.3	12.6	11.0	9.3	7.5	10.1	10.7	9.2	7.9	6.1
48.0		10.0	12.5	13.0	9.7	11.4	12.4	12.8	10.7	8.2	12.6	12.0	10.6	9.0	7.1	9.7	10.3	8.9	7.6	5.8
50.0			11.4	12.0	9.2	7.2	11.3	11.8	10.4	7.7	11.7	11.3	10.3	8.7	6.7	9.4	9.9	8.6	7.4	5.5
54.0			6.3	10.2	8.3		7.9	10.0	9.9	7.0	9.2	10.0	9.8	8.2	6.0	8.7	9.1	8.0	6.9	5.0
58.0				7.2	7.4			7.9	8.9	6.3		8.5	8.9	7.7	5.4	8.2	8.2	7.6	6.5	4.4
62.0					6.5				7.6	5.7			7.6	7.4	4.8	3.9	7.4	7.2	6.1	3.9
66.0										5.2				3.7	4.4		4.6	6.5	5.8	3.5
70.0														4.4	4.0			4.9	5.5	3.1
74.0															3.7				4.8	2.8
78.0																				2.5

Tragfähigkeiten
Lifting capacities
Capacités de levage
Capacidades de elevación







78t

DIN/ISO/EN

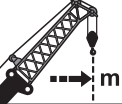
 ---> m	LFJ 6.0 m					LFJ 12.0 m					LFJ 18.0 m					LFJ 24.0 m					
	40.4 m	45.4 m	50.5 m	55.6 m	60.0 m	40.4 m	45.4 m	50.5 m	55.6 m	60.0 m	40.4 m	45.4 m	50.5 m	55.6 m	60.0 m	40.4 m	45.4 m	50.5 m	55.6 m	60.0 m	
7.0	58.6																				
8.0	58.6	51.1																			
9.0	58.6	51.1	39.9			47.4															
10.0	58.6	51.1	38.3	31.8		47.4	38.4	31.2			33.3										
11.0	58.6	51.1	36.8	30.6	28.1	47.4	38.4	31.2			33.3	29.1				23.7					
12.0	58.6	51.1	35.5	29.4	28.0	47.4	38.4	29.9	23.9		33.2	29.1	22.7			23.7	20.9				
14.0	56.8	50.5	33.2	27.3	26.1	45.2	38.4	27.7	23.9	20.9	31.1	29.1	22.7	17.9	15.7	23.0	20.9	16.8			
16.0	48.0	47.2	31.1	25.6	24.4	42.7	38.4	25.8	22.3	20.9	29.1	28.5	22.6	17.9	15.7	21.6	20.9	16.8	13.2	11.5	
18.0	41.2	40.6	29.4	24.0	23.0	40.4	38.3	24.2	20.8	19.9	27.3	27.0	21.0	17.9	15.4	20.4	19.9	16.8	13.2	11.2	
20.0	35.7	35.4	27.9	22.7	21.8	35.6	35.1	22.8	19.5	18.7	25.5	25.7	19.7	17.2	15.0	19.2	19.0	16.8	13.2	10.9	
22.0	30.8	31.0	26.5	21.5	20.6	31.3	30.9	21.5	18.4	17.7	23.9	24.4	18.5	16.1	14.6	18.1	18.0	16.1	13.2	10.6	
24.0	26.5	27.1	25.3	20.4	19.6	27.5	27.4	20.4	17.4	16.7	22.5	23.1	17.5	15.2	14.1	17.2	17.2	15.2	13.2	10.2	
26.0	23.0	23.6	24.2	19.5	18.7	24.0	24.4	19.4	16.5	15.9	21.2	21.9	16.6	14.4	13.7	16.3	16.4	14.3	12.6	9.8	
28.0	20.1	20.7	21.5	18.6	17.9	21.0	21.4	18.5	15.7	15.1	20.0	20.8	15.7	13.6	13.2	15.4	15.7	13.6	11.9	9.4	
30.0	17.6	18.2	19.0	17.8	16.7	18.5	18.9	17.7	15.0	14.4	19.0	19.5	15.0	12.9	12.6	14.6	15.0	12.9	11.3	9.0	
32.0	15.5	16.0	16.8	17.2	15.6	16.3	16.7	17.0	14.3	13.4	17.2	17.3	14.3	12.3	11.9	13.9	14.3	12.3	10.8	8.7	
34.0	13.6	14.2	14.9	15.5	14.6	14.5	14.9	15.3	13.7	12.5	15.3	15.4	13.7	11.8	11.1	13.2	13.7	11.7	10.2	8.3	
36.0	12.0	12.6	13.3	13.8	13.7	12.8	13.2	13.7	13.2	11.7	13.6	13.8	13.1	11.3	10.3	12.6	13.1	11.2	9.8	7.9	
38.0	10.6	11.1	11.9	12.4	12.5	11.4	11.8	12.2	12.7	10.9	12.2	12.3	12.6	10.8	9.6	12.0	12.5	10.7	9.3	7.5	
40.0	9.3	9.8	10.6	11.1	11.2	10.1	10.5	11.0	11.5	10.3	10.9	11.0	11.5	10.4	9.0	11.3	11.4	10.3	8.9	7.1	
42.0	8.2	8.7	9.4	9.9	10.1	9.0	9.3	9.8	10.3	9.7	9.7	9.9	10.4	10.0	8.5	10.2	10.2	9.9	8.6	6.8	
44.0	7.1	7.6	8.4	8.9	9.0	7.9	8.3	8.7	9.3	9.1	8.7	8.8	9.3	9.6	8.0	9.1	9.2	9.4	8.2	6.5	
46.0		6.7	7.4	7.9	8.0	7.0	7.3	7.8	8.3	8.2	7.7	7.9	8.3	8.6	7.5	8.2	8.2	8.5	7.9	6.1	
48.0		5.9	6.6	7.1	7.2	6.1	6.5	6.9	7.4	7.4	6.9	7.0	7.5	7.8	7.1	7.3	7.3	7.6	7.6	5.8	
50.0			5.8	6.3	6.4	5.4	5.7	6.1	6.6	6.6	6.1	6.2	6.7	7.0	6.7	6.5	6.5	6.8	7.0	5.5	
54.0			4.4	4.9	5.0		4.3	4.8	5.2	5.2	4.7	4.8	5.3	5.6	5.4	5.1	5.1	5.4	5.6	5.0	
58.0				3.8	3.8			3.6	4.1	4.0		3.7	4.1	4.4	4.3	3.9	4.0	4.2	4.4	4.2	
62.0					2.8					3.0	3.0			3.1	3.4	3.2	2.9	2.9	3.2	3.4	3.2
66.0										2.1				2.2	2.5	2.4		2.1	2.3	2.5	2.3
70.0														1.7	1.6			1.5	1.7	1.6	

 MB
+ LFJ + PS

Tragfähigkeiten
Lifting capacities
Capacités de levage
Capacidades de elevación



m	LFJ 6.0 m					LFJ 12.0 m					LFJ 18.0 m					LFJ 24.0 m				
	40.4 m	45.4 m	50.5 m	55.6 m	60.0 m	40.4 m	45.4 m	50.5 m	55.6 m	60.0 m	40.4 m	45.4 m	50.5 m	55.6 m	60.0 m	40.4 m	45.4 m	50.5 m	55.6 m	60.0 m
7.0	58.6																			
8.0	58.6	51.1																		
9.0	58.6	51.1	39.9			47.4														
10.0	58.6	51.1	38.3	31.8		47.4	38.4	31.2			33.3									
11.0	58.6	51.1	36.8	30.6	28.1	47.4	38.4	31.2			33.3	29.1				23.7				
12.0	55.3	51.1	35.5	29.4	28.0	47.4	38.4	29.9	23.9		33.2	29.1	22.7			23.7	20.9			
14.0	45.4	44.5	33.2	27.3	26.1	44.8	38.4	27.7	23.9	20.9	31.1	29.1	22.7	17.9	15.7	23.0	20.9	16.8		
16.0	38.0	37.5	31.1	25.6	24.4	37.7	37.0	25.8	22.3	20.9	29.1	28.5	22.6	17.9	15.7	21.6	20.9	16.8	13.2	11.5
18.0	32.1	31.8	29.4	24.0	23.0	32.1	31.6	24.2	20.8	19.9	27.3	27.0	21.0	17.9	15.4	20.4	19.9	16.8	13.2	11.2
20.0	27.4	27.3	27.4	22.7	21.8	27.6	27.2	22.8	19.5	18.7	25.5	25.7	19.7	17.2	15.0	19.2	19.0	16.8	13.2	10.9
22.0	23.6	23.5	23.8	21.5	20.6	23.9	23.6	21.5	18.4	17.7	23.9	23.7	18.5	16.1	14.6	18.1	18.0	16.1	13.2	10.6
24.0	20.0	20.5	20.8	20.4	19.6	20.8	20.6	20.4	17.4	16.7	21.1	20.7	17.5	15.2	14.1	17.2	17.2	15.2	13.2	10.2
26.0	17.0	17.6	18.2	18.4	18.1	17.9	18.1	18.2	16.5	15.9	18.5	18.3	16.6	14.4	13.7	16.3	16.4	14.3	12.6	9.8
28.0	14.5	15.1	15.9	16.3	16.0	15.4	15.8	16.1	15.7	15.1	16.3	16.2	15.7	13.6	13.2	15.4	15.7	13.6	11.9	9.4
30.0	12.4	13.0	13.8	14.3	14.2	13.3	13.7	14.2	14.4	14.1	14.2	14.3	14.4	12.9	12.6	14.5	14.3	12.9	11.3	9.0
32.0	10.6	11.1	11.9	12.5	12.6	11.5	11.9	12.4	12.8	12.5	12.3	12.5	12.9	12.3	11.9	12.8	12.7	12.3	10.8	8.7
34.0	9.0	9.6	10.4	10.9	11.0	9.9	10.3	10.8	11.3	11.1	10.7	10.9	11.4	11.5	11.1	11.2	11.3	11.3	10.2	8.3
36.0	7.7	8.2	9.0	9.5	9.7	8.5	8.9	9.4	9.9	9.9	9.3	9.5	10.0	10.3	10.0	9.8	9.9	10.1	9.8	7.9
38.0	6.5	7.0	7.8	8.3	8.4	7.3	7.7	8.2	8.7	8.6	8.1	8.3	8.8	9.1	8.9	8.6	8.7	8.9	9.0	7.5
40.0	5.4	5.9	6.7	7.2	7.3	6.2	6.6	7.1	7.6	7.5	7.0	7.2	7.7	8.0	7.8	7.5	7.6	7.8	8.0	7.1
42.0	4.5	5.0	5.7	6.3	6.4	5.3	5.6	6.1	6.6	6.6	6.1	6.2	6.7	7.0	6.9	6.5	6.6	6.8	7.0	6.8
44.0	3.7	4.1	4.9	5.4	5.5	4.4	4.8	5.3	5.8	5.7	5.2	5.3	5.8	6.1	6.0	5.6	5.7	5.9	6.2	6.0
46.0		3.4	4.1	4.6	4.7	3.7	4.0	4.5	5.0	4.9	4.4	4.6	5.0	5.3	5.2	4.8	4.9	5.1	5.4	5.2
48.0		2.7	3.4	3.9	4.0	3.0	3.3	3.8	4.3	4.2	3.7	3.8	4.3	4.6	4.5	4.1	4.2	4.4	4.6	4.5
50.0			2.7	3.3	3.4	2.3	2.6	3.1	3.6	3.5	3.1	3.2	3.6	3.9	3.8	3.5	3.5	3.8	4.0	3.8
54.0				1.6	2.2		1.5	2.0	2.5	2.4	1.9	2.1	2.5	2.8	2.7	2.3	2.4	2.6	2.8	2.6
58.0									1.5				1.5	1.8	1.7			1.6	1.8	1.7





UNIVERSAL
SALE & RENTAL

Hubhöhen
Lifting heights
Hauteurs de levage
Alturas de elevación

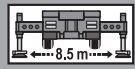
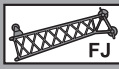
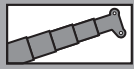

138t Heavy Duty

DIN/ISO/EN

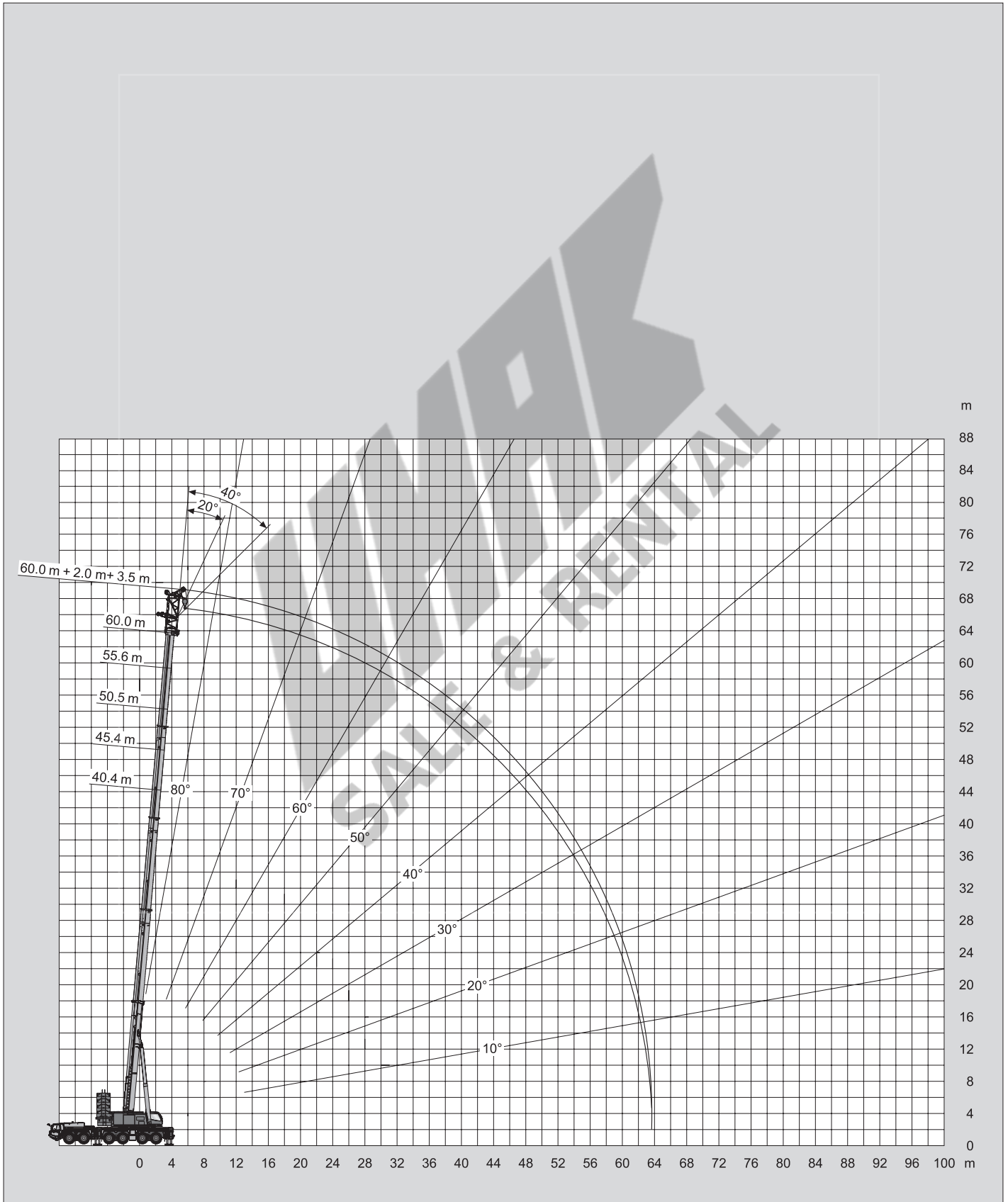

Tragfähigkeiten
Lifting capacities
Capacités de levage
Capacidades de elevación

138t Heavy Duty **DIN / ISO / EN**

m	40.4 m + 2.0 m + 3.5 m			45.4 m + 2.0 m + 3.5 m			50.5 m 2.0 m + 3.5 m			55.6 m + 2.0 m + 3.5 m			60.0 m + 2.0 m + 3.5 m		
	0°	20°	40°	0°	20°	40°	0°	20°	40°	0°	20°	40°	0°	20°	40°
8.0	48.2														
9.0	45.4	42.9		38.4											
10.0	42.9	40.7	39.3	36.5	34.3		28.7								
11.0	40.7	38.8	37.5	34.8	32.8	31.4	27.3	25.7		24.1					
12.0	38.7	37.0	35.8	33.2	31.4	30.2	26.0	24.6	23.7	23.0	21.7			21.8	
14.0	35.3	33.9	33.0	30.6	29.1	28.1	23.8	22.7	21.9	21.0	20.2	19.4	19.9	19.1	18.4
16.0	32.5	31.3	30.6	28.4	27.1	26.3	22.0	21.1	20.5	19.4	18.7	18.2	18.4	17.7	17.3
18.0	30.2	29.2	28.6	26.3	25.4	24.7	20.5	19.7	19.2	18.0	17.4	17.0	17.0	16.5	16.1
20.0	28.1	27.3	26.8	24.5	23.9	23.3	19.2	18.5	18.0	16.8	16.3	15.9	15.9	15.4	15.1
22.0	26.4	25.7	25.3	22.9	22.3	22.0	18.0	17.4	17.1	15.7	15.3	15.0	14.9	14.5	14.2
24.0	24.9	24.2	23.9	21.5	21.0	20.8	17.0	16.5	16.2	14.8	14.4	14.2	14.0	13.6	13.4
26.0	23.5	23.0	22.7	20.3	19.9	19.7	16.2	15.7	15.4	14.0	13.6	13.4	13.2	12.9	12.7
28.0	22.1	21.9	21.7	19.2	18.8	18.7	15.4	14.9	14.7	13.3	13.0	12.8	12.5	12.2	12.1
30.0	20.7	20.7	20.7	18.2	17.9	17.8	14.7	14.3	14.1	12.6	12.3	12.2	11.9	11.7	11.5
32.0	19.5	19.5	19.4	17.3	17.1	17.0	14.0	13.7	13.5	12.0	11.8	11.6	11.3	11.1	11.0
34.0	18.4	18.4	18.4	16.6	16.3	16.2	13.5	13.2	13.0	11.5	11.3	11.2	10.8	10.6	10.5
36.0	17.4	17.4	17.4	15.9	15.7	15.6	13.0	12.7	12.6	11.0	10.8	10.7	10.4	10.2	10.1
38.0	16.5	16.5		15.3	15.1	15.0	12.5	12.3	12.2	10.6	10.4	10.3	9.9	9.8	9.7
40.0	15.8	15.8		14.7	14.5	14.5	12.1	11.9	11.8	10.2	10.0	10.0	9.6	9.4	9.3
42.0	13.8	14.0		14.0	14.0		11.7	11.5	11.5	9.8	9.7	9.6	9.2	9.1	9.0
44.0	5.5			13.2	13.3		11.4	11.2	11.2	9.5	9.4	9.3	8.9	8.7	8.7
46.0				12.5	12.5		11.1	11.0		9.2	9.1	9.1	8.6	8.5	8.4
48.0				8.9			10.9	10.8		8.9	8.8	8.8	8.3	8.2	8.2
50.0							10.7	10.7		8.7	8.6		8.1	8.0	7.9
54.0							4.1			8.4	8.3		7.1	7.2	
58.0										6.3			6.1	6.2	
62.0													5.3	5.3	

118t Heavy Duty **DIN / ISO / EN**

m	40.4 m + 2.0 m + 3.5 m			45.4 m + 2.0 m + 3.5 m			50.5 m + 2.0 m + 3.5 m			55.6 m + 2.0 m + 3.5 m			60.0 m + 2.0 m + 3.5 m		
	0°	20°	40°	0°	20°	40°	0°	20°	40°	0°	20°	40°	0°	20°	40°
8.0	48.2														
9.0	45.4	42.9		38.4											
10.0	42.9	40.7	39.3	36.5	34.3		28.7								
11.0	40.7	38.8	37.5	34.8	32.8	31.4	27.3	25.7		24.1					
12.0	38.7	37.0	35.8	33.2	31.4	30.2	26.0	24.6	23.7	23.0	21.7			21.8	
14.0	35.3	33.9	33.0	30.6	29.1	28.1	23.8	22.7	21.9	21.0	20.2	19.4	19.9	19.1	18.4
16.0	32.5	31.3	30.6	28.4	27.1	26.3	22.0	21.1	20.5	19.4	18.7	18.2	18.4	17.7	17.3
18.0	30.2	29.2	28.6	26.3	25.4	24.7	20.5	19.7	19.2	18.0	17.4	17.0	17.0	16.5	16.1
20.0	28.1	27.3	26.8	24.5	23.9	23.3	19.2	18.5	18.0	16.8	16.3	15.9	15.9	15.4	15.1
22.0	26.4	25.7	25.3	22.9	22.3	22.0	18.0	17.4	17.1	15.7	15.3	15.0	14.9	14.5	14.2
24.0	24.9	24.2	23.9	21.5	21.0	20.8	17.0	16.5	16.2	14.8	14.4	14.2	14.0	13.6	13.4
26.0	23.5	23.0	22.7	20.3	19.9	19.7	16.2	15.7	15.4	14.0	13.6	13.4	13.2	12.9	12.7
28.0	22.1	21.9	21.7	19.2	18.8	18.7	15.4	14.9	14.7	13.3	13.0	12.8	12.5	12.2	12.1
30.0	20.7	20.7	20.7	18.2	17.9	17.8	14.7	14.3	14.1	12.6	12.3	12.2	11.9	11.7	11.5
32.0	19.5	19.5	19.4	17.3	17.1	17.0	14.0	13.7	13.5	12.0	11.8	11.6	11.3	11.1	11.0
34.0	18.4	18.4	18.4	16.6	16.3	16.2	13.5	13.2	13.0	11.5	11.3	11.2	10.8	10.6	10.5
36.0	17.4	17.4	17.4	15.9	15.7	15.6	13.0	12.7	12.6	11.0	10.8	10.7	10.4	10.2	10.1
38.0	16.5	16.5		15.3	15.1	15.0	12.5	12.3	12.2	10.6	10.4	10.3	9.9	9.8	9.7
40.0	15.8	15.8		14.7	14.5	14.5	12.1	11.9	11.8	10.2	10.0	10.0	9.6	9.4	9.3
42.0	13.8	14.0		14.0	14.0		11.7	11.5	11.5	9.8	9.7	9.6	9.2	9.1	9.0
44.0	5.5			13.2	13.3		11.4	11.2	11.2	9.5	9.4	9.3	8.9	8.7	8.7
46.0				12.5	12.5		11.1	11.0		9.2	9.1	9.1	8.6	8.5	8.4
48.0				8.9			10.9	10.8		8.9	8.8	8.8	8.3	8.2	8.2
50.0							10.7	10.7		8.7	8.6		8.1	8.0	7.9
54.0							4.1			8.4	8.3		7.1	7.2	
58.0										6.3			6.1	6.2	
62.0													5.3	5.3	

Tragfähigkeiten
Lifting capacities
Capacités de levage
Capacidades de elevación

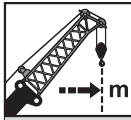

	40.4 m + 2.0 m + 3.5 m			45.4 m + 2.0 m + 3.5 m			50.5 m + 2.0 m + 3.5 m			55.6 m + 2.0 m + 3.5 m			60.0 m + 2.0 m + 3.5 m		
	0°	20°	40°	0°	20°	40°	0°	20°	40°	0°	20°	40°	0°	20°	40°
8.0	48.2														
9.0	45.4	42.9		38.4											
10.0	42.9	40.7	39.3	36.5	34.3		28.7								
11.0	40.7	38.8	37.5	34.8	32.8	31.4	27.3	25.7		24.1					
12.0	38.7	37.0	35.8	33.2	31.4	30.2	26.0	24.6	23.7	23.0	21.7			21.8	
14.0	35.3	33.9	33.0	30.6	29.1	28.1	23.8	22.7	21.9	21.0	20.2	19.4	19.9	19.1	18.4
16.0	32.5	31.3	30.6	28.4	27.1	26.3	22.0	21.1	20.5	19.4	18.7	18.2	18.4	17.7	17.3
18.0	30.2	29.2	28.6	26.3	25.4	24.7	20.5	19.7	19.2	18.0	17.4	17.0	17.0	16.5	16.1
20.0	26.0	26.6	26.8	24.5	23.9	23.3	19.2	18.5	18.0	16.8	16.3	15.9	15.9	15.4	15.1
22.0	22.2	22.7	23.1	22.1	22.3	22.0	18.0	17.4	17.1	15.7	15.3	15.0	14.9	14.5	14.2
24.0	18.7	19.2	19.4	19.1	19.5	19.8	17.0	16.5	16.2	14.8	14.4	14.2	14.0	13.6	13.4
26.0	15.9	16.3	16.5	16.2	16.6	16.9	16.2	15.7	15.4	14.0	13.6	13.4	13.2	12.9	12.7
28.0	13.5	13.8	14.0	13.9	14.2	14.4	14.5	14.9	14.7	13.3	13.0	12.8	12.5	12.2	12.1
30.0	11.5	11.8	11.9	11.9	12.2	12.3	12.5	12.9	13.0	12.6	12.3	12.2	11.9	11.7	11.5
32.0	9.8	10.1	10.2	10.2	10.4	10.6	10.8	11.1	11.3	11.4	11.7	11.6	11.3	11.1	11.0
34.0	8.4	8.6	8.6	8.7	8.9	9.0	9.3	9.6	9.7	9.9	10.2	10.3	10.0	10.3	10.4
36.0	7.1	7.3	7.3	7.4	7.6	7.7	8.1	8.3	8.4	8.6	8.9	9.0	8.7	8.9	9.1
38.0	6.0	6.1		6.3	6.5	6.5	6.9	7.1	7.2	7.5	7.7	7.8	7.5	7.8	7.9
40.0	5.0	5.1		5.3	5.4	5.4	5.9	6.1	6.1	6.5	6.6	6.7	6.5	6.7	6.8
42.0	4.2	4.2		4.4	4.5		5.0	5.2	5.2	5.6	5.7	5.8	5.6	5.8	5.9
44.0	3.5			3.6	3.7		4.2	4.3	4.3	4.7	4.9	4.9	4.8	4.9	5.0
46.0				3.0	3.0		3.5	3.6		4.0	4.1	4.2	4.1	4.2	4.2
48.0				2.3			2.9	2.9		3.4	3.5	3.5	3.4	3.5	3.5
50.0							2.3	2.3		2.8	2.8		2.8	2.9	2.9
54.0										1.7	1.8		1.7	1.8	



UNIVERSAL
SALE & RENTAL

Hubhöhen
Lifting heights
Hauteurs de levage
Alturas de elevación



DIN / ISO / EN

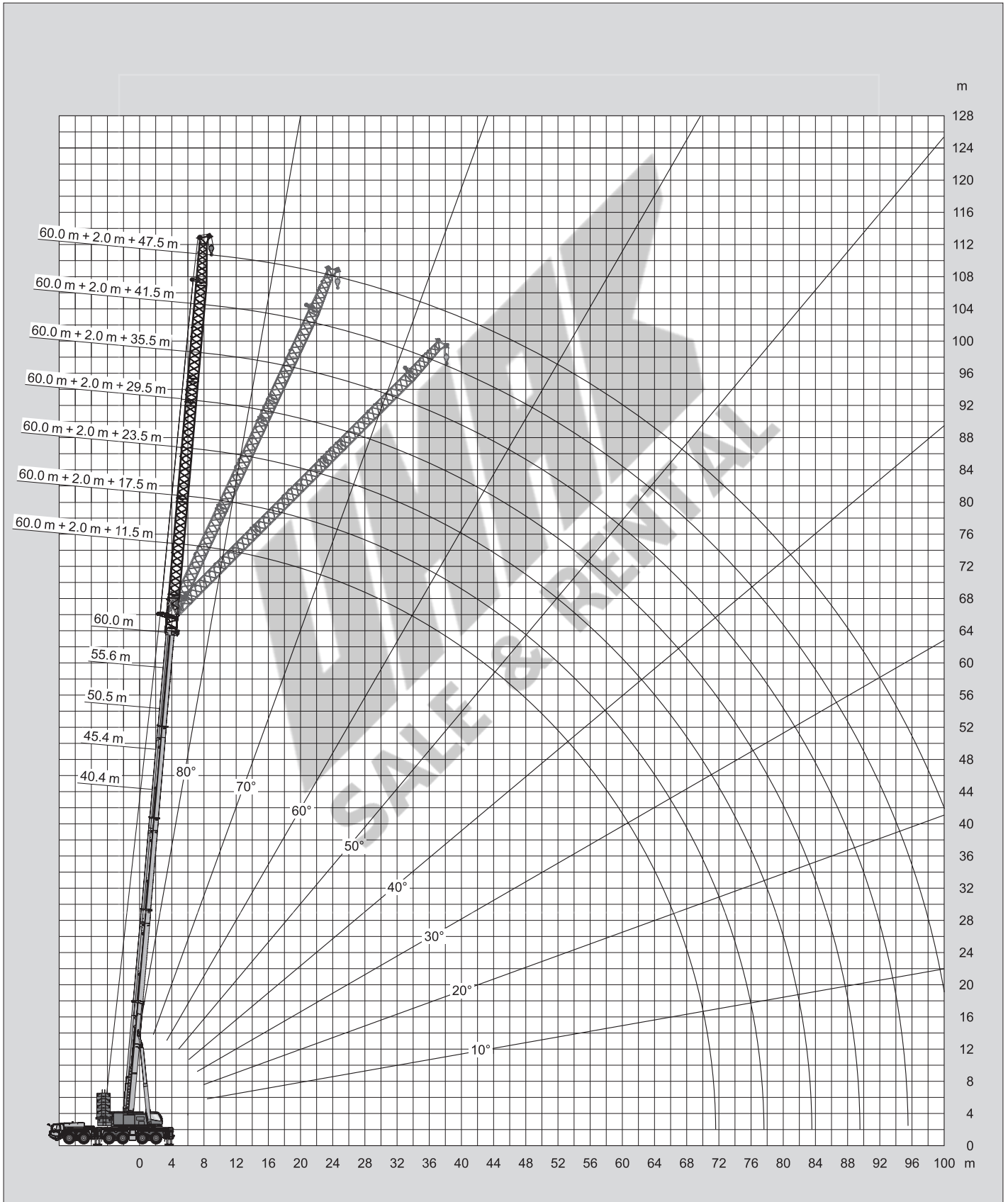

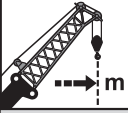

 m	40.4 m + 2.0 m + 11.5 m			45.4 m + 2.0 m + 11.5 m			50.5 m + 2.0 m + 11.5 m			55.6 m + 2.0 m + 11.5 m			60.0 m + 2.0 m + 11.5 m		
	0°	20°	40°	0°	20°	40°	0°	20°	40°	0°	20°	40°	0°	20°	40°
9.0	41.7														
10.0	39.2			33.2											
11.0	37.1			31.5			24.8								
12.0	35.1			29.9			23.5			20.8					
14.0	31.9	27.6		27.3	23.7		21.4			19.0			18.0		
16.0	29.1	26.1	22.7	25.1	22.1		19.6	16.9		17.6	15.0		16.6		
18.0	26.9	24.5	21.8	23.3	20.6	19.0	18.1	16.0	14.1	16.2	14.1		15.3	13.4	
20.0	24.9	22.9	21.0	21.7	19.4	17.9	16.9	15.2	13.5	15.0	13.3	12.1	14.2	12.6	
22.0	23.3	21.5	20.3	20.3	18.3	17.0	15.8	14.3	13.0	14.0	12.6	11.5	13.2	12.0	11.0
24.0	21.8	20.2	19.2	19.1	17.3	16.2	14.8	13.5	12.5	13.1	12.0	11.0	12.4	11.4	10.5
26.0	20.5	19.1	18.3	18.1	16.5	15.5	13.9	12.8	12.0	12.4	11.4	10.6	11.6	10.8	10.0
28.0	19.4	18.1	17.4	17.1	15.7	14.8	13.2	12.1	11.5	11.7	10.9	10.1	11.0	10.3	9.6
30.0	18.4	17.3	16.6	16.2	15.0	14.2	12.5	11.6	11.0	11.0	10.3	9.8	10.4	9.7	9.3
32.0	17.4	16.5	15.9	15.4	14.4	13.7	11.9	11.0	10.5	10.5	9.8	9.4	9.8	9.3	8.9
34.0	16.6	15.8	15.3	14.6	13.8	13.2	11.3	10.6	10.1	9.9	9.4	9.0	9.4	8.8	8.5
36.0	15.9	15.1	14.7	13.9	13.3	12.7	10.8	10.1	9.7	9.5	9.0	8.6	8.9	8.4	8.2
38.0	15.2	14.5	14.1	13.3	12.8	12.3	10.4	9.7	9.4	9.0	8.6	8.3	8.5	8.1	7.8
40.0	14.6	14.0	13.7	12.7	12.3	12.0	10.0	9.4	9.0	8.7	8.2	8.0	8.1	7.7	7.5
42.0	14.1	13.5	13.3	12.2	11.8	11.6	9.6	9.0	8.7	8.3	7.9	7.7	7.8	7.4	7.2
44.0	13.4	13.1	12.9	11.8	11.4	11.2	9.2	8.7	8.5	8.0	7.6	7.4	7.5	7.1	7.0
46.0	12.6	12.7		11.3	11.0	10.8	8.9	8.4	8.2	7.7	7.3	7.1	7.2	6.9	6.7
48.0	11.9	12.0		10.9	10.6	10.5	8.6	8.2	8.0	7.4	7.1	6.9	6.9	6.6	6.5
50.0	9.7	11.1		10.5	10.3		8.4	8.0	7.8	7.1	6.8	6.7	6.5	6.3	6.3
54.0				9.3	9.4		7.9	7.6		6.7	6.4	6.3	5.7	5.6	5.6
58.0							7.6	7.3		6.3	6.1	6.0	5.1	5.0	5.1
62.0							2.0			6.0	5.8		4.5	4.5	4.6
66.0										4.0	5.0		4.0	4.0	
70.0													3.5	3.6	



 m	40.4 m + 2.0 m + 17.5 m			45.4 m + 2.0 m + 17.5 m			50.5 m + 2.0 m + 17.5 m			55.6 m + 2.0 m + 17.5 m			60.0 m + 2.0 m + 17.5 m		
	0°	20°	40°	0°	20°	40°	0°	20°	40°	0°	20°	40°	0°	20°	40°
10.0	32.8														
11.0	31.5			28.7											
12.0	30.3			27.3			21.5								
14.0	28.1			24.8			19.7			17.1					
16.0	26.3	20.6		22.8			18.1			15.8			14.9		
18.0	24.7	19.5		21.1	18.0		16.7	13.5		14.6			13.8		
20.0	23.0	18.6		19.6	17.0		15.5	12.8		13.6	11.4		12.9		
22.0	21.4	17.8	15.4	18.3	16.0		14.4	12.2		12.7	10.8		12.1	10.3	
24.0	20.1	17.1	14.9	17.2	15.1	13.8	13.5	11.6	10.2	12.0	10.2		11.3	9.7	
26.0	18.8	16.4	14.5	16.2	14.3	13.2	12.7	11.1	9.8	11.2	9.7	8.7	10.6	9.3	8.4
28.0	17.8	15.8	14.0	15.3	13.6	12.6	11.9	10.6	9.4	10.6	9.3	8.4	10.0	8.8	8.0
30.0	16.8	15.3	13.6	14.5	13.0	12.1	11.3	10.2	9.1	10.0	8.9	8.1	9.4	8.4	7.7
32.0	15.9	14.8	13.3	13.8	12.4	11.6	10.7	9.7	8.8	9.4	8.5	7.8	8.9	8.1	7.4
34.0	15.1	14.1	13.0	13.1	11.9	11.2	10.2	9.3	8.5	8.9	8.1	7.5	8.4	7.7	7.1
36.0	14.4	13.5	12.7	12.6	11.4	10.8	9.7	8.9	8.3	8.5	7.8	7.2	8.0	7.4	6.9
38.0	13.8	12.9	12.4	12.0	11.0	10.4	9.2	8.5	8.0	8.1	7.5	7.0	7.6	7.1	6.6
40.0	13.2	12.4	12.0	11.5	10.6	10.0	8.8	8.1	7.7	7.7	7.2	6.8	7.3	6.8	6.4
42.0	12.6	11.9	11.5	11.1	10.2	9.7	8.5	7.8	7.5	7.4	6.9	6.5	6.9	6.5	6.2
44.0	12.1	11.5	11.2	10.6	9.9	9.4	8.1	7.5	7.2	7.0	6.6	6.4	6.6	6.2	6.0
46.0	11.7	11.1	10.8	10.2	9.6	9.2	7.8	7.3	7.0	6.7	6.4	6.1	6.3	6.0	5.8
48.0	11.3	10.8	10.5	9.8	9.3	8.9	7.5	7.0	6.8	6.5	6.1	5.9	5.9	5.6	5.6
50.0	10.8	10.4	10.2	9.5	9.0	8.7	7.3	6.8	6.6	6.2	5.9	5.7	5.5	5.3	5.3
54.0	9.6	9.7		8.8	8.5	8.4	6.8	6.4	6.2	5.8	5.5	5.3	4.8	4.7	4.7
58.0				7.8	8.0		6.4	6.0	5.9	5.3	5.1	5.0	4.2	4.1	4.2
62.0				4.4	6.0		6.1	5.8		4.8	4.7	4.6	3.6	3.6	3.7
66.0							5.0	5.6		4.5	4.3		3.2	3.2	3.3
70.0										4.2	4.1		2.8	2.8	
74.0													2.5	2.5	

MB + FJ

Tragfähigkeiten
Lifting capacities
Capacités de levage
Capacidades de elevación

m	40.4 m + 2.0 m + 23.5 m			45.4 m + 2.0 m + 23.5 m			50.5 m + 2.0 m + 23.5 m			55.6 m + 2.0 m + 23.5 m			60.0 m + 2.0 m + 23.5 m		
	0°	20°	40°	0°	20°	40°	0°	20°	40°	0°	20°	40°	0°	20°	40°
11.0	26.7														
12.0	25.7														
14.0	23.9			22.1			17.8								
16.0	22.2			20.7			16.3			14.3			13.6		
18.0	20.8			19.4			15.1			13.2			12.6		
20.0	19.6	15.3		18.1			14.1			12.3			11.7		
22.0	18.5	14.6		16.9	13.8		13.2	10.4		11.5			10.9		
24.0	17.5	13.9		15.8	13.2		12.3	9.9		10.8	8.9		10.2		
26.0	16.6	13.3	10.9	14.8	12.6		11.5	9.5		10.1	8.4		9.6	8.1	
28.0	15.8	12.8	10.6	14.0	12.2	10.5	10.9	9.0		9.5	8.0		9.1	7.7	
30.0	15.1	12.3	10.3	13.2	11.6	10.2	10.2	8.7	7.6	9.0	7.6	6.8	8.6	7.3	
32.0	14.5	11.9	10.0	12.5	11.1	9.9	9.7	8.3	7.3	8.6	7.3	6.5	8.1	7.0	6.3
34.0	13.9	11.4	9.8	11.9	10.6	9.7	9.2	8.0	7.0	8.1	7.0	6.3	7.7	6.7	6.0
36.0	13.3	11.1	9.5	11.3	10.1	9.4	8.7	7.7	6.8	7.7	6.7	6.1	7.3	6.4	5.8
38.0	12.7	10.7	9.3	10.8	9.7	9.0	8.3	7.4	6.6	7.3	6.4	5.8	6.9	6.1	5.6
40.0	12.1	10.4	9.1	10.4	9.3	8.7	7.9	7.1	6.4	6.9	6.2	5.6	6.5	5.9	5.4
42.0	11.6	10.1	8.9	9.9	9.0	8.4	7.5	6.9	6.2	6.6	5.9	5.4	6.2	5.7	5.1
44.0	11.1	9.8	8.8	9.5	8.6	8.1	7.2	6.6	6.1	6.3	5.7	5.3	5.8	5.4	4.9
46.0	10.7	9.6	8.7	9.2	8.3	7.9	6.9	6.3	5.9	6.0	5.5	5.1	5.4	5.1	4.7
48.0	10.2	9.3	8.5	8.8	8.1	7.6	6.6	6.1	5.8	5.7	5.3	4.9	5.0	4.8	4.5
50.0	9.9	9.1	8.4	8.5	7.8	7.4	6.4	5.9	5.6	5.4	5.1	4.8	4.6	4.4	4.3
54.0	9.2	8.7	8.3	7.9	7.3	7.0	5.9	5.5	5.2	4.8	4.6	4.4	4.0	3.9	3.9
58.0	8.2	8.2	8.1	7.4	6.9	6.7	5.4	5.1	4.9	4.3	4.1	4.0	3.4	3.4	3.4
62.0	5.9	7.4		6.6	6.6	6.5	5.0	4.7	4.5	3.8	3.7	3.6	2.9	2.9	3.0
66.0				5.7	6.0		4.6	4.3	4.3	3.5	3.3	3.3	2.5	2.5	2.6
70.0							4.3	4.1		3.1	3.0	3.0	2.1	2.1	2.3
74.0										2.9	2.8		1.8	1.8	1.9
78.0										1.8	2.6		1.5	1.6	

m	40.4 m + 2.0 m + 29.5 m			45.4 m + 2.0 m + 29.5 m			50.5 m + 2.0 m + 29.5 m			55.6 m + 2.0 m + 29.5 m			60.0 m + 2.0 m + 29.5 m		
	0°	20°	40°	0°	20°	40°	0°	20°	40°	0°	20°	40°	0°	20°	40°
12.0	21.9														
14.0	20.4			18.9											
16.0	19.0			17.7			14.8			13.6					
18.0	17.8			16.7			13.7			12.5			11.9		
20.0	16.7			15.7			12.7			11.6			11.0		
22.0	15.8			14.9			11.9			10.7			10.2		
24.0	14.9	10.9		14.1	10.8		11.1			10.0			9.6		
26.0	14.1	10.4		13.4	10.3		10.5	8.2		9.4			9.0		
28.0	13.4	10.0		12.7	9.9		9.9	7.9		8.8	7.2		8.4		
30.0	12.8	9.6		12.1	9.5		9.3	7.5		8.3	6.9		7.9	6.6	
32.0	12.2	9.2	7.5	11.4	9.1	7.5	8.8	7.2		7.9	6.6		7.5	6.3	
34.0	11.6	8.8	7.3	10.8	8.8	7.3	8.3	6.9	6.0	7.5	6.3		7.1	5.9	
36.0	11.1	8.5	7.1	10.3	8.5	7.1	7.9	6.6	5.7	7.1	6.0	5.3	6.7	5.5	
38.0	10.6	8.2	6.9	9.8	8.2	6.9	7.5	6.3	5.5	6.7	5.7	5.1	6.4	5.2	4.4
40.0	10.1	7.9	6.8	9.3	7.9	6.7	7.1	6.1	5.4	6.4	5.5	4.9	5.9	4.9	4.2
42.0	9.7	7.7	6.6	8.9	7.7	6.5	6.8	5.9	5.2	6.1	5.2	4.7	5.4	4.6	4.0
44.0	9.3	7.4	6.4	8.5	7.4	6.4	6.4	5.7	5.0	5.8	5.0	4.6	5.0	4.3	3.8
46.0	8.9	7.2	6.3	8.2	7.2	6.3	6.1	5.5	4.9	5.4	4.8	4.4	4.6	4.1	3.6
48.0	8.6	7.0	6.2	7.8	7.0	6.1	5.9	5.3	4.7	5.1	4.7	4.2	4.2	3.9	3.4
50.0	8.3	6.8	6.1	7.5	6.8	6.0	5.5	5.1	4.6	4.7	4.4	4.1	3.9	3.6	3.3
54.0	7.7	6.5	5.9	7.0	6.3	5.8	4.9	4.5	4.3	4.1	3.9	3.8	3.3	3.2	3.0
58.0	7.3	6.2	5.8	6.5	5.9	5.6	4.4	4.1	3.9	3.6	3.4	3.3	2.8	2.7	2.7
62.0	6.8	6.0	5.7	5.9	5.5	5.2	4.0	3.7	3.5	3.2	3.0	2.9	2.3	2.3	2.4
66.0	6.0	5.9		5.3	5.1	4.9	3.6	3.3	3.2	2.8	2.6	2.6	1.9	1.9	2.0
70.0				4.7	4.7		3.2	3.0	2.9	2.4	2.3	2.3	1.5	1.6	1.7
74.0				2.0	4.1		3.0	2.8		2.1	2.0	2.0			
78.0							2.4	2.6		1.8	1.7	1.7			
82.0										1.6	1.5				

Tragfähigkeiten
Lifting capacities
Capacités de levage
Capacidades de elevación

360°
138t
DIN / ISO / EN

m	40.4 m + 2.0 m + 35.5 m			45.4 m + 2.0 m + 35.5 m			50.5 m + 2.0 m + 35.5 m			55.6 m + 2.0 m + 35.5 m			60.0 m + 2.0 m + 35.5 m		
	0°	20°	40°	0°	20°	40°	0°	20°	40°	0°	20°	40°	0°	20°	40°
14.0	17.2														
16.0	16.2			15.1											
18.0	15.3			14.3			12.9			11.0					
20.0	14.5			13.6			12.1			10.7			9.7		
22.0	13.7			12.9			11.3			9.9			9.5		
24.0	12.8			12.3			10.5			9.2			8.8		
26.0	12.0	8.5		11.7			9.9			8.6			8.2		
28.0	11.3	8.1		11.1	8.1		9.3			8.1			7.7		
30.0	10.7	7.8		10.6	7.7		8.7	6.9		7.6			7.3		
32.0	10.1	7.5		10.1	7.4		8.3	6.6		7.2	5.9		6.9	5.4	
34.0	9.6	7.1		9.7	7.1		7.8	6.3		6.8	5.6		6.5	5.0	
36.0	9.1	6.9	5.6	9.2	6.8		7.4	6.0		6.4	5.3		6.1	4.7	
38.0	8.7	6.6	5.4	8.8	6.6	5.4	7.1	5.7		6.1	5.1		5.8	4.4	
40.0	8.3	6.3	5.3	8.4	6.3	5.2	6.7	5.5	4.8	5.8	4.9		5.3	4.1	
42.0	7.9	6.1	5.1	8.1	6.1	5.1	6.4	5.3	4.6	5.5	4.7	4.1	4.9	3.9	3.3
44.0	7.6	5.9	5.0	7.7	5.9	4.9	6.1	5.1	4.5	5.2	4.5	3.9	4.5	3.6	3.1
46.0	7.3	5.7	4.8	7.4	5.7	4.8	5.8	4.9	4.3	4.8	4.3	3.7	4.1	3.4	2.9
48.0	7.0	5.5	4.7	7.1	5.5	4.7	5.4	4.7	4.2	4.5	4.0	3.5	3.7	3.2	2.7
50.0	6.7	5.3	4.6	6.8	5.4	4.6	5.1	4.6	4.0	4.1	3.8	3.3	3.4	3.0	2.6
54.0	6.2	5.0	4.4	6.2	5.0	4.4	4.5	4.1	3.7	3.6	3.4	3.0	2.8	2.6	2.3
58.0	5.8	4.8	4.3	5.6	4.8	4.2	3.9	3.6	3.4	3.0	2.9	2.7	2.3	2.3	2.0
62.0	5.4	4.5	4.1	5.1	4.5	4.1	3.5	3.2	3.0	2.6	2.5	2.4	1.9	1.9	1.8
66.0	5.1	4.3	4.1	4.6	4.1	3.9	3.1	2.8	2.7	2.2	2.1	2.1	1.5	1.6	1.6
70.0	4.8	4.2	4.1	4.2	3.8	3.6	2.7	2.5	2.4	1.9	1.8	1.8			
74.0	3.2	4.2		3.8	3.5	3.4	2.4	2.2	2.1	1.5	1.5	1.5			
78.0				3.1	3.3		2.1	2.0	1.9						
82.0							1.9	1.8							

360°
138t
DIN / ISO / EN



m	40.4 m + 2.0 m + 41.5 m			45.4 m + 2.0 m + 41.5 m			50.5 m + 2.0 m + 41.5 m			55.6 m + 2.0 m + 41.5 m			60.0 m + 2.0 m + 41.5 m		
	0°	20°	40°	0°	20°	40°	0°	20°	40°	0°	20°	40°	0°	20°	40°
16.0	13.4			12.3											
18.0	12.7			11.7			10.5								
20.0	12.0			11.1			10.0			8.9					
22.0	11.3			10.5			9.6			8.6			7.9		
24.0	10.6			10.0			9.2			8.2			7.7		
26.0	10.0			9.5			8.8			7.8			7.4		
28.0	9.3			9.1			8.3			7.3			6.9		
30.0	8.8	6.2		8.7			7.8			6.8			6.5		
32.0	8.3	5.9		8.3	5.8		7.3			6.4			6.1		
34.0	7.8	5.6		7.9	5.6		6.9	5.4		6.0			5.6		
36.0	7.4	5.4		7.5	5.3		6.5	5.2		5.7	4.6		5.1	3.7	
38.0	7.0	5.1		7.1	5.1		6.2	4.9		5.3	4.3		4.7	3.4	
40.0	6.6	4.9		6.7	4.9		5.9	4.7		5.0	4.0		4.3	3.1	
42.0	6.3	4.7	3.8	6.4	4.7		5.5	4.4		4.6	3.7		3.9	2.9	
44.0	6.0	4.5	3.6	6.1	4.5	3.6	5.1	4.2		4.2	3.4		3.6	2.7	
46.0	5.7	4.3	3.5	5.8	4.3	3.5	4.8	3.9	3.2	3.8	3.2		3.3	2.5	
48.0	5.5	4.1	3.4	5.6	4.2	3.4	4.4	3.7	3.0	3.5	3.0	2.5	2.9	2.3	1.9
50.0	5.2	4.0	3.3	5.3	4.0	3.3	4.1	3.5	2.9	3.2	2.7	2.3	2.6	2.1	1.7
54.0	4.8	3.7	3.0	4.9	3.7	3.1	3.5	3.1	2.5	2.6	2.4	2.0	2.1	1.7	
58.0	4.4	3.4	2.8	4.5	3.5	2.9	3.0	2.7	2.3	2.1	2.0	1.7	1.6		
62.0	4.0	3.2	2.7	4.0	3.2	2.7	2.5	2.3	2.0	1.7	1.6				
66.0	3.7	3.0	2.5	3.5	3.0	2.5	2.1	1.9	1.8						
70.0	3.5	2.8	2.4	3.1	2.7	2.4	1.8	1.6	1.5						
74.0	3.2	2.6	2.4	2.8	2.4	2.3									
78.0	3.0	2.5		2.4	2.1	2.0									
82.0				2.2	1.9	1.8									

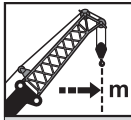

Tragfähigkeiten
Lifting capacities
Capacités de levage
Capacidades de elevación



	40.4 m + 2.0 m + 47.5 m			45.4 m + 2.0 m + 47.5 m			50.5 m + 2.0 m + 47.5 m			55.6 m + 2.0 m + 47.5 m			60.0 m + 2.0 m + 47.5 m		
	0°	20°	40°	0°	20°	40°	0°	20°	40°	0°	20°	40°	0°	20°	40°
16.0	10.7														
18.0	10.1			9.3											
20.0	9.6			8.8			7.8								
22.0	9.0			8.3			7.5			6.5					
24.0	8.5			7.9			7.1			6.3			5.8		
26.0	8.1			7.5			6.8			6.0			5.6		
28.0	7.6			7.1			6.5			5.8			5.4		
30.0	7.2			6.8			6.2			5.6			5.2		
32.0	6.7			6.5			5.9			5.3			4.9		
34.0	6.3	4.4		6.2			5.6			5.1			4.7		
36.0	6.0	4.1		5.9	4.1		5.4			4.9			4.2		
38.0	5.6	3.9		5.6	3.9		5.2	3.8		4.6			3.8		
40.0	5.3	3.7		5.3	3.7		4.9	3.6		4.2	3.1		3.5	2.3	
42.0	5.0	3.5		5.1	3.5		4.7	3.5		3.8	2.8		3.1	2.1	
44.0	4.7	3.4		4.8	3.4		4.4	3.2		3.5	2.6		2.8	1.9	
46.0	4.5	3.2		4.6	3.2		4.0	3.0		3.2	2.4		2.5	1.7	
48.0	4.2	3.0	2.2	4.3	3.0		3.6	2.8		2.8	2.1		2.2	1.5	
50.0	4.0	2.9	2.0	4.1	2.9	2.0	3.3	2.6		2.5	1.9		2.0		
54.0	3.6	2.6	1.8	3.7	2.6	1.8	2.7	2.2	1.6	2.0	1.5		1.5		
58.0	3.3	2.3	1.6	3.4	2.4	1.6	2.2	1.9		1.5					
62.0	2.9	2.0	1.5	3.1	2.1	1.5	1.8	1.6							
66.0	2.6	1.8		2.6	1.9										
70.0	2.3	1.6		2.2	1.7										
74.0	2.0			1.8	1.5										
78.0	1.8			1.5											
82.0	1.6														

SALE & RENTAL

															
DIN / ISO / EN															
 m	40.4 m + 2.0 m + 11.5 m			45.4 m + 2.0 m + 11.5 m			50.5 m + 2.0 m + 11.5 m			55.6 m + 2.0 m + 11.5 m			60.0 m + 2.0 m + 11.5 m		
	0°	20°	40°	0°	20°	40°	0°	20°	40°	0°	20°	40°	0°	20°	40°
9.0	41.7														
10.0	39.2			33.2											
11.0	37.1			31.5			24.8								
12.0	35.1			29.9			23.5				20.8				
14.0	31.9	27.6		27.3	23.7		21.4			19.0			18.0		
16.0	29.1	26.1	22.7	25.1	22.1		19.6	16.9		17.6	15.0		16.6		
18.0	26.9	24.5	21.8	23.3	20.6	19.0	18.1	16.0	14.1	16.2	14.1		15.3	13.4	
20.0	24.9	22.9	21.0	21.7	19.4	17.9	16.9	15.2	13.5	15.0	13.3	12.1	14.2	12.6	
22.0	23.3	21.5	20.3	20.3	18.3	17.0	15.8	14.3	13.0	14.0	12.6	11.5	13.2	12.0	11.0
24.0	21.8	20.2	19.2	19.1	17.3	16.2	14.8	13.5	12.5	13.1	12.0	11.0	12.4	11.4	10.5
26.0	20.5	19.1	18.3	18.1	16.5	15.5	13.9	12.8	12.0	12.4	11.4	10.6	11.6	10.8	10.0
28.0	19.4	18.1	17.4	17.1	15.7	14.8	13.2	12.1	11.5	11.7	10.9	10.1	11.0	10.3	9.6
30.0	18.4	17.3	16.6	16.2	15.0	14.2	12.5	11.6	11.0	11.0	10.3	9.8	10.4	9.7	9.3
32.0	17.4	16.5	15.9	15.4	14.4	13.7	11.9	11.0	10.5	10.5	9.8	9.4	9.8	9.3	8.9
34.0	16.6	15.8	15.3	14.6	13.8	13.2	11.3	10.6	10.1	9.9	9.4	9.0	9.4	8.8	8.5
36.0	15.9	15.1	14.7	13.9	13.3	12.7	10.8	10.1	9.7	9.5	9.0	8.6	8.9	8.4	8.2
38.0	15.2	14.5	14.1	13.3	12.8	12.3	10.4	9.7	9.4	9.0	8.6	8.3	8.5	8.1	7.8
40.0	14.6	14.0	13.7	12.7	12.3	12.0	10.0	9.4	9.0	8.7	8.2	8.0	8.1	7.7	7.5
42.0	14.1	13.5	13.3	12.2	11.8	11.6	9.6	9.0	8.7	8.3	7.9	7.7	7.8	7.4	7.2
44.0	13.4	13.1	12.9	11.8	11.4	11.2	9.2	8.7	8.5	8.0	7.6	7.4	7.5	7.1	7.0
46.0	12.6	12.7		11.3	11.0	10.8	8.9	8.4	8.2	7.7	7.3	7.1	7.2	6.9	6.7
48.0	11.9	12.0		10.9	10.6	10.5	8.6	8.2	8.0	7.4	7.1	6.9	6.9	6.6	6.5
50.0	9.7	11.1		10.5	10.3		8.4	8.0	7.8	7.1	6.8	6.7	6.5	6.3	6.3
54.0				9.3	9.4		7.9	7.6		6.7	6.4	6.3	5.7	5.6	5.6
58.0							7.6	7.3		6.3	6.1	6.0	5.1	5.0	5.1
62.0							2.0			6.0	5.8		4.5	4.5	4.6
66.0										4.0	5.0		4.0	4.0	
70.0													3.5	3.6	

															
DIN / ISO / EN															
 m	40.4 m + 2.0 m + 17.5 m			45.4 m + 2.0 m + 17.5 m			50.5 m + 2.0 m + 17.5 m			55.6 m + 2.0 m + 17.5 m			60.0 m + 2.0 m + 17.5 m		
	0°	20°	40°	0°	20°	40°	0°	20°	40°	0°	20°	40°	0°	20°	40°
10.0	32.8														
11.0	31.5			28.7											
12.0	30.3			27.3			21.5								
14.0	28.1			24.8			19.7				17.1				
16.0	26.3	20.6		22.8			18.1				15.8			14.9	
18.0	24.7	19.5		21.1	18.0		16.7	13.5			14.6			13.8	
20.0	23.0	18.6		19.6	17.0		15.5	12.8			13.6	11.4		12.9	
22.0	21.4	17.8	15.4	18.3	16.0		14.4	12.2			12.7	10.8		12.1	10.3
24.0	20.1	17.1	14.9	17.2	15.1	13.8	13.5	11.6	10.2		12.0	10.2		11.3	9.7
26.0	18.8	16.4	14.5	16.2	14.3	13.2	12.7	11.1	9.8		11.2	9.7	8.7	10.6	9.3
28.0	17.8	15.8	14.0	15.3	13.6	12.6	11.9	10.6	9.4		10.6	9.3	8.4	10.0	8.8
30.0	16.8	15.3	13.6	14.5	13.0	12.1	11.3	10.2	9.1		10.0	8.9	8.1	9.4	8.4
32.0	15.9	14.8	13.3	13.8	12.4	11.6	10.7	9.7	8.8		9.4	8.5	7.8	8.9	8.1
34.0	15.1	14.1	13.0	13.1	11.9	11.2	10.2	9.3	8.5		8.9	8.1	7.5	8.4	7.7
36.0	14.4	13.5	12.7	12.6	11.4	10.8	9.7	8.9	8.3		8.5	7.8	7.2	8.0	7.4
38.0	13.8	12.9	12.4	12.0	11.0	10.4	9.2	8.5	8.0		8.1	7.5	7.0	7.6	7.1
40.0	13.2	12.4	12.0	11.5	10.6	10.0	8.8	8.1	7.7		7.7	7.2	6.8	7.3	6.8
42.0	12.6	11.9	11.5	11.1	10.2	9.7	8.5	7.8	7.5		7.4	6.9	6.5	6.9	6.5
44.0	12.1	11.5	11.2	10.6	9.9	9.4	8.1	7.5	7.2		7.0	6.6	6.4	6.6	6.2
46.0	11.7	11.1	10.8	10.2	9.6	9.2	7.8	7.3	7.0		6.7	6.4	6.1	6.3	6.0
48.0	11.3	10.8	10.5	9.8	9.3	8.9	7.5	7.0	6.8		6.5	6.1	5.9	5.9	5.6
50.0	10.8	10.4	10.2	9.5	9.0	8.7	7.3	6.8	6.6		6.2	5.9	5.7	5.5	5.3
54.0	9.6	9.7		8.8	8.5	8.4	6.8	6.4	6.2		5.8	5.5	5.3	4.8	4.7
58.0				7.8	8.0		6.4	6.0	5.9		5.3	5.1	5.0	4.2	4.1
62.0				4.4	6.0		6.1	5.8			4.8	4.7	4.6	3.6	3.6
66.0							5.0	5.6			4.5	4.3		3.2	3.2
70.0											4.2	4.1		2.8	2.8
74.0														2.5	2.5

Tragfähigkeiten
Lifting capacities
Capacités de levage
Capacidades de elevación



DIN / ISO / EN

m	40.4 m + 2.0 m + 23.5 m			45.4 m + 2.0 m + 23.5 m			50.5 m + 2.0 m + 23.5 m			55.6 m + 2.0 m + 23.5 m			60.0 m + 2.0 m + 23.5 m		
	0°	20°	40°	0°	20°	40°	0°	20°	40°	0°	20°	40°	0°	20°	40°
11.0	26.7														
12.0	25.7														
14.0	23.9						17.8								
16.0	22.2			22.1			16.3			14.3			13.6		
18.0	20.8			19.4			15.1			13.2			12.6		
20.0	19.6	15.3		18.1			14.1			12.3			11.7		
22.0	18.5	14.6		16.9	13.8		13.2	10.4		11.5			10.9		
24.0	17.5	13.9		15.8	13.2		12.3	9.9		10.8	8.9		10.2		
26.0	16.6	13.3	10.9	14.8	12.6		11.5	9.5		10.1	8.4		9.6	8.1	
28.0	15.8	12.8	10.6	14.0	12.2	10.5	10.9	9.0		9.5	8.0		9.1	7.7	
30.0	15.1	12.3	10.3	13.2	11.6	10.2	10.2	8.7	7.6	9.0	7.6	6.8	8.6	7.3	
32.0	14.5	11.9	10.0	12.5	11.1	9.9	9.7	8.3	7.3	8.6	7.3	6.5	8.1	7.0	6.3
34.0	13.9	11.4	9.8	11.9	10.6	9.7	9.2	8.0	7.0	8.1	7.0	6.3	7.7	6.7	6.0
36.0	13.3	11.1	9.5	11.3	10.1	9.4	8.7	7.7	6.8	7.7	6.7	6.1	7.3	6.4	5.8
38.0	12.7	10.7	9.3	10.8	9.7	9.0	8.3	7.4	6.6	7.3	6.4	5.8	6.9	6.1	5.6
40.0	12.1	10.4	9.1	10.4	9.3	8.7	7.9	7.1	6.4	6.9	6.2	5.6	6.5	5.9	5.4
42.0	11.6	10.1	8.9	9.9	9.0	8.4	7.5	6.9	6.2	6.6	5.9	5.4	6.2	5.7	5.1
44.0	11.1	9.8	8.8	9.5	8.6	8.1	7.2	6.6	6.1	6.3	5.7	5.3	5.8	5.4	4.9
46.0	10.7	9.6	8.7	9.2	8.3	7.9	6.9	6.3	5.9	6.0	5.5	5.1	5.4	5.1	4.7
48.0	10.2	9.3	8.5	8.8	8.1	7.6	6.6	6.1	5.8	5.7	5.3	4.9	5.0	4.8	4.5
50.0	9.9	9.1	8.4	8.5	7.8	7.4	6.4	5.9	5.6	5.4	5.1	4.8	4.6	4.4	4.3
54.0	9.2	8.7	8.3	7.9	7.3	7.0	5.9	5.5	5.2	4.8	4.6	4.4	4.0	3.9	3.9
58.0	8.2	8.2	8.1	7.4	6.9	6.7	5.4	5.1	4.9	4.3	4.1	4.0	3.4	3.4	3.4
62.0	5.9	7.4		6.6	6.6	6.5	5.0	4.7	4.5	3.8	3.7	3.6	2.9	2.9	3.0
66.0				5.7	6.0		4.6	4.3	4.3	3.5	3.3	3.3	2.5	2.5	2.6
70.0							4.3	4.1		3.1	3.0	3.0	2.1	2.1	2.3
74.0										2.9	2.8		1.8	1.8	1.9
78.0										1.8	2.6		1.5	1.6	



DIN / ISO / EN

m	40.4 m + 2.0 m + 29.5 m			45.4 m + 2.0 m + 29.5 m			50.5 m + 2.0 m + 29.5 m			55.6 m + 2.0 m + 29.5 m			60.0 m + 2.0 m + 29.5 m		
	0°	20°	40°	0°	20°	40°	0°	20°	40°	0°	20°	40°	0°	20°	40°
12.0	21.9														
14.0	20.4			18.9											
16.0	19.0			17.7			14.8			13.6					
18.0	17.8			16.7			13.7			12.5			11.9		
20.0	16.7			15.7			12.7			11.6			11.0		
22.0	15.8			14.9			11.9			10.7			10.2		
24.0	14.9	10.9		14.1	10.8		11.1			10.0			9.6		
26.0	14.1	10.4		13.4	10.3		10.5	8.2		9.4			9.0		
28.0	13.4	10.0		12.7	9.9		9.9	7.9		8.8	7.2		8.4		
30.0	12.8	9.6		12.1	9.5		9.3	7.5		8.3	6.9		7.9	6.6	
32.0	12.2	9.2	7.5	11.4	9.1	7.5	8.8	7.2		7.9	6.6		7.5	6.3	
34.0	11.6	8.8	7.3	10.8	8.8	7.3	8.3	6.9	6.0	7.5	6.3		7.1	5.9	
36.0	11.1	8.5	7.1	10.3	8.5	7.1	7.9	6.6	5.7	7.1	6.0	5.3	6.7	5.5	
38.0	10.6	8.2	6.9	9.8	8.2	6.9	7.5	6.3	5.5	6.7	5.7	5.1	6.4	5.2	4.4
40.0	10.1	7.9	6.8	9.3	7.9	6.7	7.1	6.1	5.4	6.4	5.5	4.9	5.9	4.9	4.2
42.0	9.7	7.7	6.6	8.9	7.7	6.5	6.8	5.9	5.2	6.1	5.2	4.7	5.4	4.6	4.0
44.0	9.3	7.4	6.4	8.5	7.4	6.4	6.4	5.7	5.0	5.8	5.0	4.6	5.0	4.3	3.8
46.0	8.9	7.2	6.3	8.2	7.2	6.3	6.1	5.5	4.9	5.4	4.8	4.4	4.6	4.1	3.6
48.0	8.6	7.0	6.2	7.8	7.0	6.1	5.9	5.3	4.7	5.1	4.7	4.2	4.2	3.9	3.4
50.0	8.3	6.8	6.1	7.5	6.8	6.0	5.5	5.1	4.6	4.7	4.4	4.1	3.9	3.6	3.3
54.0	7.7	6.5	5.9	7.0	6.3	5.8	4.9	4.5	4.3	4.1	3.9	3.8	3.3	3.2	3.0
58.0	7.3	6.2	5.8	6.5	5.9	5.6	4.4	4.1	3.9	3.6	3.4	3.3	2.8	2.7	2.7
62.0	6.8	6.0	5.7	5.9	5.5	5.2	4.0	3.7	3.5	3.2	3.0	2.9	2.3	2.3	2.4
66.0	6.0	5.9		5.3	5.1	4.9	3.6	3.3	3.2	2.8	2.6	2.6	1.9	1.9	2.0
70.0				4.7	4.7		3.2	3.0	2.9	2.4	2.3	2.3	1.5	1.6	1.7
74.0				2.0	4.1		3.0	2.8		2.1	2.0	2.0			
78.0							2.4	2.6		1.8	1.7	1.7			
82.0										1.6	1.5				

Tragfähigkeiten
Lifting capacities
Capacités de levage
Capacidades de elevación

118t

DIN / ISO / EN

m	40.4 m + 2.0 m + 35.5 m			45.4 m + 2.0 m + 35.5 m			50.5 m + 2.0 m + 35.5 m			55.6 m + 2.0 m + 35.5 m			60.0 m + 2.0 m + 35.5 m		
	0°	20°	40°	0°	20°	40°	0°	20°	40°	0°	20°	40°	0°	20°	40°
14.0	17.2														
16.0	16.2			15.1											
18.0	15.3			14.3			12.9			11.0					
20.0	14.5			13.6			12.1			10.7			9.7		
22.0	13.7			12.9			11.3			9.9			9.5		
24.0	12.8			12.3			10.5			9.2			8.8		
26.0	12.0	8.5		11.7			9.9			8.6			8.2		
28.0	11.3	8.1		11.1	8.1		9.3			8.1			7.7		
30.0	10.7	7.8		10.6	7.7		8.7	6.9		7.6			7.3		
32.0	10.1	7.5		10.1	7.4		8.3	6.6		7.2	5.9		6.9	5.4	
34.0	9.6	7.1		9.7	7.1		7.8	6.3		6.8	5.6		6.5	5.0	
36.0	9.1	6.9	5.6	9.2	6.8		7.4	6.0		6.4	5.3		6.1	4.7	
38.0	8.7	6.6	5.4	8.8	6.6	5.4	7.1	5.7		6.1	5.1		5.8	4.4	
40.0	8.3	6.3	5.3	8.4	6.3	5.2	6.7	5.5	4.8	5.8	4.9		5.3	4.1	
42.0	7.9	6.1	5.1	8.1	6.1	5.1	6.4	5.3	4.6	5.5	4.7	4.1	4.9	3.9	3.3
44.0	7.6	5.9	5.0	7.7	5.9	4.9	6.1	5.1	4.5	5.2	4.5	3.9	4.5	3.6	3.1
46.0	7.3	5.7	4.8	7.4	5.7	4.8	5.8	4.9	4.3	4.8	4.3	3.7	4.1	3.4	2.9
48.0	7.0	5.5	4.7	7.1	5.5	4.7	5.4	4.7	4.2	4.5	4.0	3.5	3.7	3.2	2.7
50.0	6.7	5.3	4.6	6.8	5.4	4.6	5.1	4.6	4.0	4.1	3.8	3.3	3.4	3.0	2.6
54.0	6.2	5.0	4.4	6.2	5.0	4.4	4.5	4.1	3.7	3.6	3.4	3.0	2.8	2.6	2.3
58.0	5.8	4.8	4.3	5.6	4.8	4.2	3.9	3.6	3.4	3.0	2.9	2.7	2.3	2.3	2.0
62.0	5.4	4.5	4.1	5.1	4.5	4.1	3.5	3.2	3.0	2.6	2.5	2.4	1.9	1.9	1.8
66.0	5.1	4.3	4.1	4.6	4.1	3.9	3.1	2.8	2.7	2.2	2.1	2.1	1.5	1.6	1.6
70.0	4.8	4.2	4.1	4.2	3.8	3.6	2.7	2.5	2.4	1.9	1.8	1.8			
74.0	3.2	4.2		3.8	3.5	3.4	2.4	2.2	2.1	1.5	1.5	1.5			
78.0				3.1	3.3		2.1	2.0	1.9						
82.0							1.9	1.8							

118t

DIN / ISO / EN

m	40.4 m + 2.0 m + 41.5 m			45.4 m + 2.0 m + 41.5 m			50.5 m + 2.0 m + 41.5 m			55.6 m + 2.0 m + 41.5 m			60.0 m + 2.0 m + 41.5 m		
	0°	20°	40°	0°	20°	40°	0°	20°	40°	0°	20°	40°	0°	20°	40°
16.0	13.4			12.3											
18.0	12.7			11.7			10.5								
20.0	12.0			11.1			10.0			8.9					
22.0	11.3			10.5			9.6			8.6			7.9		
24.0	10.6			10.0			9.2			8.2			7.7		
26.0	10.0			9.5			8.8			7.8			7.4		
28.0	9.3			9.1			8.3			7.3			6.9		
30.0	8.8	6.2		8.7			7.8			6.8			6.5		
32.0	8.3	5.9		8.3	5.8		7.3			6.4			6.1		
34.0	7.8	5.6		7.9	5.6		6.9	5.4		6.0			5.6		
36.0	7.4	5.4		7.5	5.3		6.5	5.2		5.7	4.6		5.1	3.7	
38.0	7.0	5.1		7.1	5.1		6.2	4.9		5.3	4.3		4.7	3.4	
40.0	6.6	4.9		6.7	4.9		5.9	4.7		5.0	4.0		4.3	3.1	
42.0	6.3	4.7	3.8	6.4	4.7		5.5	4.4		4.6	3.7		3.9	2.9	
44.0	6.0	4.5	3.6	6.1	4.5	3.6	5.1	4.2		4.2	3.4		3.6	2.7	
46.0	5.7	4.3	3.5	5.8	4.3	3.5	4.8	3.9	3.2	3.8	3.2		3.3	2.5	
48.0	5.5	4.1	3.4	5.6	4.2	3.4	4.4	3.7	3.0	3.5	3.0	2.5	2.9	2.3	1.9
50.0	5.2	4.0	3.3	5.3	4.0	3.3	4.1	3.5	2.9	3.2	2.7	2.3	2.6	2.1	1.7
54.0	4.8	3.7	3.0	4.9	3.7	3.1	3.5	3.1	2.5	2.6	2.4	2.0	2.1	1.7	
58.0	4.4	3.4	2.8	4.5	3.5	2.9	3.0	2.7	2.3	2.1	2.0	1.7	1.6		
62.0	4.0	3.2	2.7	4.0	3.2	2.7	2.5	2.3	2.0	1.7	1.6				
66.0	3.7	3.0	2.5	3.5	3.0	2.5	2.1	1.9	1.8						
70.0	3.5	2.8	2.4	3.1	2.7	2.4	1.8	1.6	1.5						
74.0	3.2	2.6	2.4	2.8	2.4	2.3									
78.0	3.0	2.5		2.4	2.1	2.0									
82.0				2.2	1.9	1.8									

Tragfähigkeiten
Lifting capacities
Capacités de levage
Capacidades de elevación

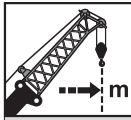

	40.4 m + 2.0 m + 47.5 m			45.4 m + 2.0 m + 47.5 m			50.5 m + 2.0 m + 47.5 m			55.6 m + 2.0 m + 47.5 m			60.0 m + 2.0 m + 47.5 m		
	0°	20°	40°	0°	20°	40°	0°	20°	40°	0°	20°	40°	0°	20°	40°
16.0	10.7														
18.0	10.1			9.3											
20.0	9.6			8.8			7.8								
22.0	9.0			8.3			7.5			6.5					
24.0	8.5			7.9			7.1			6.3			5.8		
26.0	8.1			7.5			6.8			6.0			5.6		
28.0	7.6			7.1			6.5			5.8			5.4		
30.0	7.2			6.8			6.2			5.6			5.2		
32.0	6.7			6.5			5.9			5.3			4.9		
34.0	6.3	4.4		6.2			5.6			5.1			4.7		
36.0	6.0	4.1		5.9	4.1		5.4			4.9			4.2		
38.0	5.6	3.9		5.6	3.9		5.2	3.8		4.6			3.8		
40.0	5.3	3.7		5.3	3.7		4.9	3.6		4.2	3.1		3.5	2.3	
42.0	5.0	3.5		5.1	3.5		4.7	3.5		3.8	2.8		3.1	2.1	
44.0	4.7	3.4		4.8	3.4		4.4	3.2		3.5	2.6		2.8	1.9	
46.0	4.5	3.2		4.6	3.2		4.0	3.0		3.2	2.4		2.5	1.7	
48.0	4.2	3.0	2.2	4.3	3.0		3.6	2.8		2.8	2.1		2.2	1.5	
50.0	4.0	2.9	2.0	4.1	2.9	2.0	3.3	2.6		2.5	1.9		2.0		
54.0	3.6	2.6	1.8	3.7	2.6	1.8	2.7	2.2	1.6	2.0	1.5		1.5		
58.0	3.3	2.3	1.6	3.4	2.4	1.6	2.2	1.9		1.5					
62.0	2.9	2.0	1.5	3.1	2.1	1.5	1.8	1.6							
66.0	2.6	1.8		2.6	1.9										
70.0	2.3	1.6		2.2	1.7										
74.0	2.0			1.8	1.5										
78.0	1.8			1.5											
82.0	1.6														

SALE & RENTAL

Tragfähigkeiten
Lifting capacities
Capacités de levage
Capacidades de elevación

58t

DIN / ISO / EN

m	40.4 m + 2.0 m + 11.5 m			45.4 m + 2.0 m + 11.5 m			50.5 m + 2.0 m + 11.5 m			55.6 m + 2.0 m + 11.5 m			60.0 m + 2.0 m + 11.5 m		
	0°	20°	40°	0°	20°	40°	0°	20°	40°	0°	20°	40°	0°	20°	40°
9.0	41.7														
10.0	39.2			33.2											
11.0	37.1			31.5			24.8								
12.0	35.1			29.9			23.5			20.8					
14.0	31.9	27.6		27.3	23.7		21.4			19.0			18.0		
16.0	29.1	26.1	22.7	25.1	22.1		19.6	16.9		17.6	15.0		16.6		
18.0	26.9	24.5	21.8	23.3	20.6	19.0	18.1	16.0	14.1	16.2	14.1		15.3	13.4	
20.0	24.9	22.9	21.0	21.7	19.4	17.9	16.9	15.2	13.5	15.0	13.3	12.1	14.2	12.6	
22.0	22.2	21.5	20.3	20.3	18.3	17.0	15.8	14.3	13.0	14.0	12.6	11.5	13.2	12.0	11.0
24.0	19.3	20.2	19.2	19.0	17.3	16.2	14.8	13.5	12.5	13.1	12.0	11.0	12.4	11.4	10.5
26.0	16.7	18.2	18.3	16.7	16.5	15.5	13.9	12.8	12.0	12.4	11.4	10.6	11.6	10.8	10.0
28.0	14.3	15.7	16.7	14.6	15.7	14.8	13.2	12.1	11.5	11.7	10.9	10.1	11.0	10.3	9.6
30.0	12.4	13.5	14.4	12.6	13.8	14.2	12.5	11.6	11.0	11.0	10.3	9.8	10.4	9.7	9.3
32.0	10.6	11.7	12.5	10.9	12.0	12.8	11.2	11.0	10.5	10.5	9.8	9.4	9.8	9.3	8.9
34.0	9.2	10.1	10.8	9.4	10.4	11.1	9.7	10.6	10.1	9.9	9.4	9.0	9.4	8.8	8.5
36.0	7.9	8.7	9.3	8.1	9.0	9.6	8.5	9.3	9.7	8.9	9.0	8.6	8.7	8.4	8.2
38.0	6.8	7.5	8.0	7.0	7.8	8.3	7.3	8.1	8.7	7.7	8.6	8.3	7.6	8.1	7.8
40.0	5.8	6.4	6.8	6.0	6.7	7.1	6.3	7.0	7.5	6.7	7.5	8.0	6.6	7.4	7.5
42.0	4.9	5.4	5.7	5.1	5.7	6.1	5.4	6.1	6.5	5.8	6.5	7.0	5.7	6.4	6.9
44.0	4.1	4.6	4.8	4.3	4.8	5.1	4.6	5.2	5.6	5.0	5.6	6.0	4.9	5.5	6.0
46.0	3.4	3.8		3.5	4.0	4.3	3.9	4.4	4.7	4.3	4.8	5.2	4.1	4.7	5.1
48.0	2.8	3.1		2.9	3.3	3.5	3.2	3.7	4.0	3.6	4.1	4.4	3.5	4.0	4.4
50.0	2.2	2.4		2.3	2.7		2.6	3.0	3.2	3.0	3.5	3.7	2.8	3.4	3.7
54.0					1.5		1.6	1.9		1.9	2.3	2.5	1.8	2.2	2.4
58.0															

58t

DIN / ISO / EN

m	40.4 m + 2.0 m + 17.5 m			45.4 m + 2.0 m + 17.5 m			50.5 m + 2.0 m + 17.5 m			55.6 m + 2.0 m + 17.5 m			60.0 m + 2.0 m + 17.5 m		
	0°	20°	40°	0°	20°	40°	0°	20°	40°	0°	20°	40°	0°	20°	40°
10.0	32.8														
11.0	31.5			28.7											
12.0	30.3			27.3			21.5								
14.0	28.1			24.8			19.7			17.1					
16.0	26.3	20.6		22.8			18.1			15.8			14.9		
18.0	24.7	19.5		21.1	18.0		16.7	13.5		14.6			13.8		
20.0	23.0	18.6		19.6	17.0		15.5	12.8		13.6	11.4		12.9		
22.0	21.4	17.8	15.4	18.3	16.0		14.4	12.2		12.7	10.8		12.1	10.3	
24.0	19.4	17.1	14.9	17.2	15.1	13.8	13.5	11.6	10.2	12.0	10.2		11.3	9.7	
26.0	17.0	16.4	14.5	16.2	14.3	13.2	12.7	11.1	9.8	11.2	9.7	8.7	10.6	9.3	8.4
28.0	15.0	15.8	14.0	14.6	13.6	12.6	11.9	10.6	9.4	10.6	9.3	8.4	10.0	8.8	8.0
30.0	12.9	14.7	13.6	12.9	13.0	12.1	11.3	10.2	9.1	10.0	8.9	8.1	9.4	8.4	7.7
32.0	11.2	12.8	13.3	11.2	12.4	11.6	10.7	9.7	8.8	9.4	8.5	7.8	8.9	8.1	7.4
34.0	9.7	11.2	12.3	9.7	11.9	11.2	10.1	9.3	8.5	8.9	8.1	7.5	8.4	7.7	7.1
36.0	8.4	9.7	10.8	8.4	9.8	10.8	8.8	8.9	8.3	8.5	7.8	7.2	8.0	7.4	6.9
38.0	7.3	8.5	9.4	7.3	8.5	9.5	7.7	8.5	8.0	7.9	7.5	7.0	7.6	7.1	6.6
40.0	6.3	7.3	8.1	6.3	7.4	8.3	6.6	7.8	7.7	6.8	7.2	6.8	6.7	6.8	6.4
42.0	5.4	6.3	7.0	5.4	6.4	7.1	5.7	6.8	7.5	5.9	6.9	6.5	5.7	6.5	6.2
44.0	4.6	5.4	6.0	4.6	5.5	6.1	4.9	5.9	6.6	5.1	6.1	6.4	4.9	6.0	6.0
46.0	3.8	4.6	5.0	3.8	4.7	5.2	4.2	5.0	5.7	4.4	5.3	5.9	4.2	5.1	5.8
48.0	3.2	3.8	4.2	3.2	3.9	4.4	3.5	4.3	4.8	3.7	4.5	5.1	3.5	4.4	5.1
50.0	2.6	3.1	3.4	2.6	3.2	3.6	2.9	3.6	4.1	3.1	3.8	4.4	2.9	3.7	4.3
54.0	1.6	1.9		1.5	2.0	2.2	1.8	2.4	2.7	2.0	2.7	3.1	1.8	2.5	3.0
58.0									1.6		1.6	1.9			1.9

MB + FJ

Tragfähigkeiten
Lifting capacities
Capacités de levage
Capacidades de elevación

m	40.4 m + 2.0 m + 23.5 m			45.4 m + 2.0 m + 23.5 m			50.5 m + 2.0 m + 23.5 m			55.6 m + 2.0 m + 23.5 m			60.0 m + 2.0 m + 23.5 m		
	0°	20°	40°	0°	20°	40°	0°	20°	40°	0°	20°	40°	0°	20°	40°
11.0	26.7														
12.0	25.7														
14.0	23.9			22.1			17.8								
16.0	22.2			20.7			16.3			14.3			13.6		
18.0	20.8			19.4			15.1			13.2			12.6		
20.0	19.6	15.3		18.1			14.1			12.3			11.7		
22.0	18.5	14.6		16.9	13.8		13.2	10.4		11.5			10.9		
24.0	17.5	13.9		15.8	13.2		12.3	9.9		10.8	8.9		10.2		
26.0	16.6	13.3	10.9	14.8	12.6		11.5	9.5		10.1	8.4		9.6	8.1	
28.0	15.0	12.8	10.6	14.0	12.2	10.5	10.9	9.0		9.5	8.0		9.1	7.7	
30.0	13.2	12.3	10.3	12.9	11.6	10.2	10.2	8.7	7.6	9.0	7.6	6.8	8.6	7.3	
32.0	11.7	11.9	10.0	11.4	11.1	9.9	9.7	8.3	7.3	8.6	7.3	6.5	8.1	7.0	6.3
34.0	10.2	11.4	9.8	10.1	10.6	9.7	9.2	8.0	7.0	8.1	7.0	6.3	7.7	6.7	6.0
36.0	8.9	10.6	9.5	8.8	10.1	9.4	8.7	7.7	6.8	7.7	6.7	6.1	7.3	6.4	5.8
38.0	7.7	9.3	9.3	7.7	9.3	9.0	7.8	7.4	6.6	7.3	6.4	5.8	6.9	6.1	5.6
40.0	6.7	8.2	9.1	6.6	8.2	8.7	6.8	7.1	6.4	6.9	6.2	5.6	6.5	5.9	5.4
42.0	5.8	7.1	8.2	5.7	7.1	8.3	5.9	6.9	6.2	6.0	5.9	5.4	5.7	5.7	5.1
44.0	5.0	6.2	7.1	4.9	6.2	7.2	5.0	6.4	6.1	5.2	5.7	5.3	4.9	5.4	4.9
46.0	4.2	5.3	6.1	4.1	5.3	6.2	4.3	5.5	5.9	4.4	5.5	5.1	4.2	5.1	4.7
48.0	3.5	4.5	5.3	3.5	4.6	5.4	3.6	4.7	5.6	3.7	4.9	4.9	3.5	4.7	4.5
50.0	2.9	3.8	4.4	2.9	3.8	4.6	3.0	4.0	4.8	3.1	4.2	4.8	2.9	4.0	4.3
54.0	1.9	2.6	2.9	1.8	2.6	3.1	1.9	2.8	3.4	2.0	3.0	3.6		2.8	3.6
58.0		1.5	1.6		1.5	1.9		1.7	2.2		1.9	2.5			2.4

m	40.4 m + 2.0 m + 29.5 m			45.4 m + 2.0 m + 29.5 m			50.5 m + 2.0 m + 29.5 m			55.6 m + 2.0 m + 29.5 m			60.0 m + 2.0 m + 29.5 m		
	0°	20°	40°	0°	20°	40°	0°	20°	40°	0°	20°	40°	0°	20°	40°
12.0	21.9														
14.0	20.4			18.9											
16.0	19.0			17.7			14.8			13.6					
18.0	17.8			16.7			13.7			12.5			11.9		
20.0	16.7			15.7			12.7			11.6			11.0		
22.0	15.8			14.9			11.9			10.7			10.2		
24.0	14.9	10.9		14.1	10.8		11.1			10.0			9.6		
26.0	14.1	10.4		13.4	10.3		10.5	8.2		9.4			9.0		
28.0	13.4	10.0		12.7	9.9		9.9	7.9		8.8	7.2		8.4		
30.0	12.8	9.6		12.1	9.5		9.3	7.5		8.3	6.9		7.9	6.6	
32.0	11.6	9.2	7.5	11.2	9.1	7.5	8.8	7.2		7.9	6.6		7.5	6.3	
34.0	10.3	8.8	7.3	9.9	8.8	7.3	8.3	6.9	6.0	7.5	6.3		7.1	5.9	
36.0	9.1	8.5	7.1	8.8	8.5	7.1	7.9	6.6	5.7	7.1	6.0	5.3	6.7	5.5	
38.0	7.9	8.2	6.9	7.8	8.2	6.9	7.5	6.3	5.5	6.7	5.7	5.1	6.4	5.2	4.4
40.0	6.9	7.9	6.8	6.7	7.9	6.7	6.8	6.1	5.4	6.4	5.5	4.9	5.9	4.9	4.2
42.0	5.9	7.7	6.6	5.8	7.6	6.5	5.9	5.9	5.2	6.0	5.2	4.7	5.4	4.6	4.0
44.0	5.1	6.7	6.4	5.0	6.6	6.4	5.1	5.7	5.0	5.2	5.0	4.6	4.8	4.3	3.8
46.0	4.4	5.8	6.3	4.2	5.8	6.3	4.3	5.5	4.9	4.5	4.8	4.4	4.2	4.1	3.6
48.0	3.7	5.0	6.1	3.6	5.0	6.1	3.6	5.1	4.7	3.9	4.7	4.2	3.5	3.9	3.4
50.0	3.1	4.3	5.3	2.9	4.3	5.3	3.0	4.4	4.6	3.3	4.4	4.1	3.0	3.6	3.3
54.0	2.0	3.0	3.8	1.9	3.0	3.8	1.9	3.1	4.0	2.2	3.4	3.8		3.2	3.0
58.0		1.9	2.4		1.9	2.6		2.0	2.8		2.3	3.1			2.7
62.0											2.0				

Tragfähigkeiten
Lifting capacities
Capacités de levage
Capacidades de elevación

58t

DIN / ISO / EN

	40.4 m + 2.0 m + 35.5 m			45.4 m + 2.0 m + 35.5 m			50.5 m + 2.0 m + 35.5 m			55.6 m + 2.0 m + 35.5 m			60.0 m + 2.0 m + 35.5 m		
	0°	20°	40°	0°	20°	40°	0°	20°	40°	0°	20°	40°	0°	20°	40°
14.0	17.2														
16.0	16.2			15.1											
18.0	15.3			14.3			12.9			11.0					
20.0	14.5			13.6			12.1			10.7			9.7		
22.0	13.7			12.9			11.3			9.9			9.5		
24.0	12.8			12.3			10.5			9.2			8.8		
26.0	12.0	8.5		11.7			9.9			8.6			8.2		
28.0	11.3	8.1		11.1	8.1		9.3			8.1			7.7		
30.0	10.7	7.8		10.6	7.7		8.7	6.9		7.6			7.3		
32.0	10.1	7.5		10.1	7.4		8.3	6.6		7.2	5.9		6.9	5.4	
34.0	9.6	7.1		9.7	7.1		7.8	6.3		6.8	5.6		6.5	5.0	
36.0	9.1	6.9	5.6	8.8	6.8		7.4	6.0		6.4	5.3		6.1	4.7	
38.0	8.2	6.6	5.4	7.8	6.6	5.4	7.1	5.7		6.1	5.1		5.8	4.4	
40.0	7.1	6.3	5.3	6.9	6.3	5.2	6.7	5.5	4.8	5.8	4.9		5.3	4.1	
42.0	6.2	6.1	5.1	6.0	6.1	5.1	6.1	5.3	4.6	5.5	4.7	4.1	4.9	3.9	3.3
44.0	5.4	5.9	5.0	5.2	5.9	4.9	5.3	5.1	4.5	5.2	4.5	3.9	4.5	3.6	3.1
46.0	4.6	5.7	4.8	4.5	5.7	4.8	4.6	4.9	4.3	4.5	4.3	3.7	4.1	3.4	2.9
48.0	3.9	5.5	4.7	3.8	5.5	4.7	4.0	4.7	4.2	3.9	4.0	3.5	3.5	3.2	2.7
50.0	3.3	4.8	4.6	3.1	4.8	4.6	3.4	4.6	4.0	3.3	3.8	3.3	2.9	3.0	2.6
54.0	2.2	3.5	4.4	2.1	3.5	4.4	2.3	3.7	3.7	2.3	3.4	3.0		2.6	2.3
58.0		2.4	3.3		2.3	3.3		2.6	3.4		2.7	2.7			2.0
62.0			2.1			2.2			2.5		2.4	2.4			

58t

DIN / ISO / EN

	40.4 m + 2.0 m + 41.5 m			45.4 m + 2.0 m + 41.5 m			50.5 m + 2.0 m + 41.5 m			55.6 m + 2.0 m + 41.5 m			60.0 m + 2.0 m + 41.5 m		
	0°	20°	40°	0°	20°	40°	0°	20°	40°	0°	20°	40°	0°	20°	40°
16.0	13.4			12.3											
18.0	12.7			11.7			10.5								
20.0	12.0			11.1			10.0			8.9					
22.0	11.3			10.5			9.6			8.6			7.9		
24.0	10.6			10.0			9.2			8.2			7.7		
26.0	10.0			9.5			8.8			7.8			7.4		
28.0	9.3			9.1			8.3			7.3			6.9		
30.0	8.8	6.2		8.7			7.8			6.8			6.5		
32.0	8.3	5.9		8.3	5.8		7.3			6.4			6.1		
34.0	7.8	5.6		7.9	5.6		6.9	5.4		6.0			5.6		
36.0	7.4	5.4		7.5	5.3		6.5	5.2		5.7	4.6		5.1	3.7	
38.0	7.0	5.1		7.1	5.1		6.2	4.9		5.3	4.3		4.7	3.4	
40.0	6.6	4.9		6.6	4.9		5.9	4.7		5.0	4.0		4.3	3.1	
42.0	6.2	4.7	3.8	5.8	4.7		5.5	4.4		4.6	3.7		3.9	2.9	
44.0	5.4	4.5	3.6	5.0	4.5	3.6	4.9	4.2		4.2	3.4		3.6	2.7	
46.0	4.7	4.3	3.5	4.3	4.3	3.5	4.2	3.9	3.2	3.8	3.2		3.3	2.5	
48.0	4.0	4.1	3.4	3.7	4.2	3.4	3.6	3.7	3.0	3.4	3.0	2.5	2.9	2.3	1.9
50.0	3.4	4.0	3.3	3.1	4.0	3.3	3.0	3.5	2.9	2.9	2.7	2.3		2.1	1.7
54.0	2.3	3.7	3.0		3.7	3.1		3.1	2.5		2.4	2.0		1.7	
58.0		2.7	2.8		2.6	2.9		2.6	2.3			1.7			
62.0		1.7	2.7			2.7			2.0						

MB + FJ

Tragfähigkeiten
Lifting capacities
Capacités de levage
Capacidades de elevación

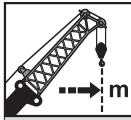

	40.4 m + 2.0 m + 47.5 m			45.4 m + 2.0 m + 47.5 m			50.5 m + 2.0 m + 47.5 m			55.6 m + 2.0 m + 47.5 m			60.0 m + 2.0 m + 47.5 m		
	0°	20°	40°	0°	20°	40°	0°	20°	40°	0°	20°	40°	0°	20°	40°
16.0	10.7														
18.0	10.1			9.3											
20.0	9.6			8.8			7.8								
22.0	9.0			8.3			7.5			6.5					
24.0	8.5			7.9			7.1			6.3				5.8	
26.0	8.1			7.5			6.8			6.0				5.6	
28.0	7.6			7.1			6.5			5.8				5.4	
30.0	7.2			6.8			6.2			5.6				5.2	
32.0	6.7			6.5			5.9			5.3				4.9	
34.0	6.3	4.4		6.2			5.6			5.1				4.7	
36.0	6.0	4.1		5.9	4.1		5.4			4.9				4.2	
38.0	5.6	3.9		5.6	3.9		5.2	3.8		4.6				3.8	
40.0	5.3	3.7		5.3	3.7		4.9	3.6		4.2	3.1			3.5	2.3
42.0	5.0	3.5		5.1	3.5		4.7	3.5		3.8	2.8			3.1	2.1
44.0	4.7	3.4		4.8	3.4		4.4	3.2		3.5	2.6			2.8	1.9
46.0	4.5	3.2		4.2	3.2		4.0	3.0		3.2	2.4			2.5	1.7
48.0	3.9	3.0	2.2	3.5	3.0		3.4	2.8		2.8	2.1				1.5
50.0	3.3	2.9	2.0	2.9	2.9	2.0	2.8	2.6			1.9				
54.0	2.2	2.6	1.8		2.6	1.8		2.2	1.6		1.5				
58.0		2.3	1.6		2.4	1.6									
62.0			1.5			1.5									

WINDY
SALE & RENTAL



UNIVERSAL
SALE & RENTAL

Hubhöhen
Lifting heights
Hauteurs de levage
Alturas de elevación







138t Heavy Duty
DIN/ISO/EN

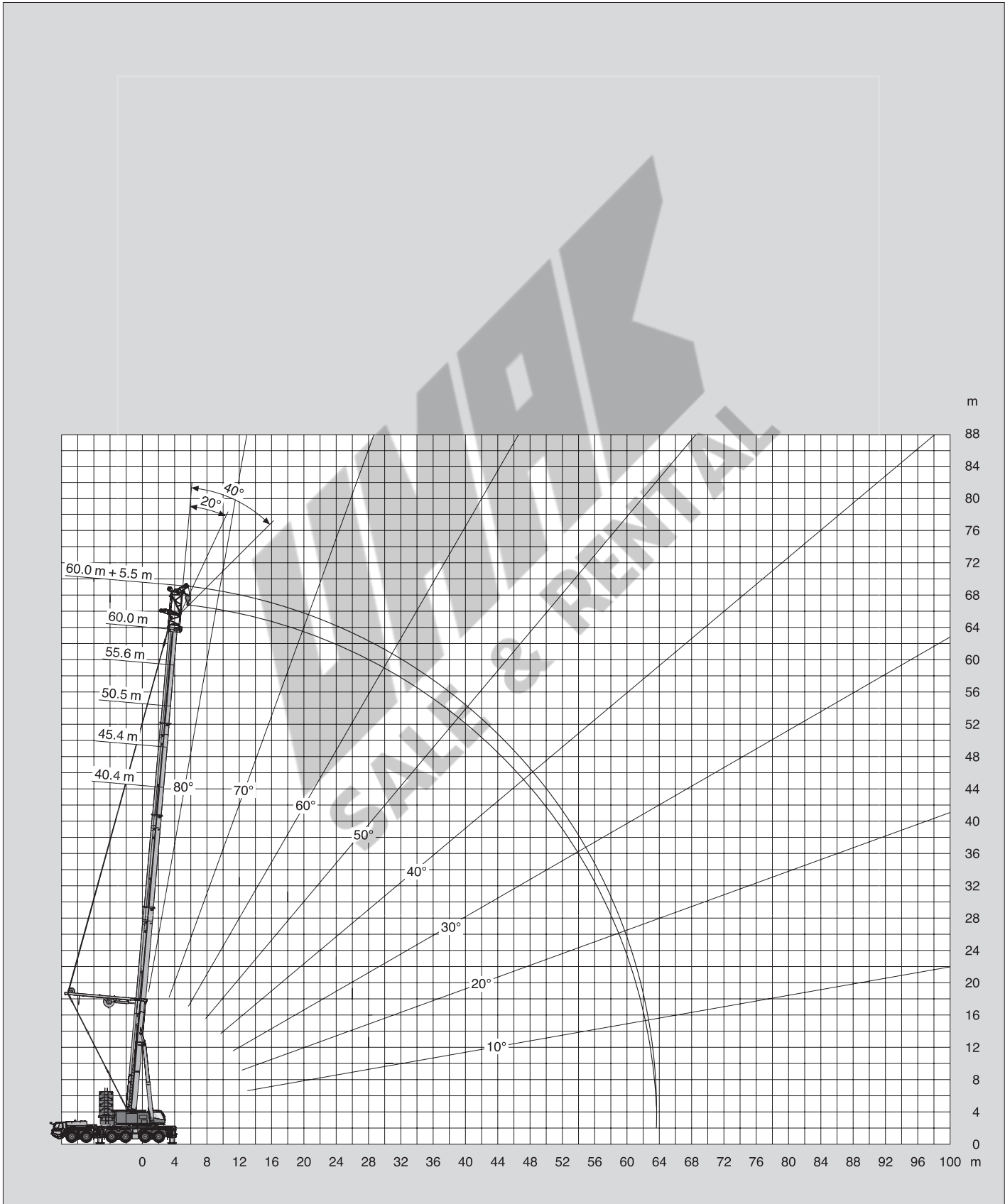

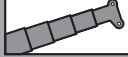
 --- m	40.4 m + 2.0 m + 3.5 m			45.4 m + 2.0 m + 3.5 m			50.5 m + 2.0 m + 3.5 m			55.6 m + 2.0 m + 3.5 m			60.0 m + 2.0 m + 3.5 m		
	0°	20°	40°	0°	20°	40°	0°	20°	40°	0°	20°	40°	0°	20°	40°
8.0	58.6			52.9											
9.0	58.6	58.6													
10.0	58.6	58.6	53.9	52.5	48.8		35.2								
11.0	58.6	57.7	52.9	51.2	47.7	45.5	34.0	30.6			28.6				
12.0	58.6	56.5	51.9	50.0	46.7	44.6	32.9	29.7	27.6	27.6	25.4		26.2		
14.0	56.8	54.2	50.2	47.8	44.8	42.9	30.9	28.1	26.3	25.8	23.8	22.6	24.6	22.8	21.6
16.0	50.2	48.4	47.2	45.9	43.2	41.5	29.2	26.7	25.1	24.2	22.5	21.4	23.1	21.5	20.5
18.0	44.8	43.4	42.5	42.5	41.1	40.3	27.7	25.4	24.1	22.8	21.3	20.3	21.8	20.4	19.5
20.0	40.3	39.2	38.6	38.3	37.2	36.5	26.3	24.3	23.2	21.5	20.2	19.4	20.6	19.4	18.6
22.0	36.5	35.7	35.2	34.7	33.8	33.3	25.1	23.4	22.3	20.4	19.3	18.5	19.6	18.5	17.8
24.0	33.3	32.7	32.3	31.6	30.9	30.6	24.1	22.5	21.6	19.5	18.4	17.8	18.7	17.7	17.1
26.0	30.6	30.1	29.8	29.0	28.4	28.2	23.1	21.7	20.9	18.6	17.6	17.1	17.8	16.9	16.4
28.0	28.2	27.7	27.6	26.7	26.3	26.0	22.3	21.0	20.3	17.8	16.9	16.5	16.8	16.3	15.8
30.0	26.0	25.7	25.6	24.7	24.3	24.2	21.5	20.3	19.7	17.1	16.3	15.9	15.6	15.2	14.9
32.0	24.2	23.9	23.8	22.9	22.6	22.5	20.8	19.7	19.2	16.4	15.7	15.3	14.5	14.1	13.9
34.0	22.5	22.3	22.3	21.3	21.1	21.0	20.2	19.2	18.8	15.8	15.2	14.9	13.5	13.2	13.0
36.0	21.0	20.9	20.9	19.8	19.7	19.6	19.4	18.7	18.4	15.3	14.7	14.4	12.6	12.3	12.2
38.0	19.2	19.5		18.6	18.4	18.4	18.1	18.0	17.9	14.8	14.3	14.0	11.8	11.6	11.5
40.0	16.1	16.4		17.4	17.3	17.3	17.0	16.8	16.8	14.3	13.9	13.7	11.0	10.9	10.8
42.0	12.2	12.4		16.3	16.2		16.0	15.9	15.8	13.9	13.5	13.3	10.4	10.2	10.2
44.0	3.8			14.3	14.6		15.0	14.9	14.9	13.5	13.2	13.1	9.7	9.6	9.6
46.0				11.5	11.7		14.2	14.1		13.2	12.9	12.8	9.2	9.1	9.1
48.0				7.4			13.0	13.2		12.9	12.6	12.6	8.7	8.6	8.6
50.0							10.7	11.0		12.4	12.3		8.2	8.1	8.1
54.0							2.5			10.0	10.2		7.1	7.2	
58.0										4.9			6.1	6.2	
62.0													4.4	4.4	

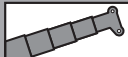
 --- m	40.4 m + 2.0 m + 3.5 m			45.4 m + 2.0 m + 3.5 m			50.5 m + 2.0 m + 3.5 m			55.6 m + 2.0 m + 3.5 m			60.0 m + 2.0 m + 3.5 m		
	0°	20°	40°	0°	20°	40°	0°	20°	40°	0°	20°	40°	0°	20°	40°
8.0	58.6			52.9											
9.0	58.6	58.6													
10.0	58.6	58.6	53.9	52.5	48.8		35.2								
11.0	58.6	57.7	52.9	51.2	47.7	45.5	34.0	30.6			28.6				
12.0	58.6	56.5	51.9	50.0	46.7	44.6	32.9	29.7	27.6	27.6	25.4		26.2		
14.0	56.8	54.2	50.2	47.8	44.8	42.9	30.9	28.1	26.3	25.8	23.8	22.6	24.6	22.8	21.6
16.0	50.2	48.4	47.2	45.9	43.2	41.5	29.2	26.7	25.1	24.2	22.5	21.4	23.1	21.5	20.5
18.0	44.8	43.4	42.5	42.5	41.1	40.3	27.7	25.4	24.1	22.8	21.3	20.3	21.8	20.4	19.5
20.0	40.3	39.2	38.6	38.3	37.2	36.5	26.3	24.3	23.2	21.5	20.2	19.4	20.6	19.4	18.6
22.0	36.5	35.7	35.2	34.7	33.8	33.3	25.1	23.4	22.3	20.4	19.3	18.5	19.6	18.5	17.8
24.0	33.3	32.7	32.3	31.6	30.9	30.6	24.1	22.5	21.6	19.5	18.4	17.8	18.7	17.7	17.1
26.0	30.6	30.1	29.8	29.0	28.4	28.2	23.1	21.7	20.9	18.6	17.6	17.1	17.8	16.9	16.4
28.0	28.2	27.7	27.6	26.7	26.3	26.0	22.3	21.0	20.3	17.8	16.9	16.5	16.8	16.3	15.8
30.0	26.0	25.7	25.6	24.7	24.3	24.2	21.5	20.3	19.7	17.1	16.3	15.9	15.6	15.2	14.9
32.0	23.4	23.7	23.8	22.9	22.6	22.5	20.8	19.7	19.2	16.4	15.7	15.3	14.5	14.1	13.9
34.0	20.9	21.1	21.2	21.3	21.1	21.0	20.2	19.2	18.8	15.8	15.2	14.9	13.5	13.2	13.0
36.0	18.7	18.9	18.9	19.2	19.5	19.5	19.4	18.7	18.4	15.3	14.7	14.4	12.6	12.3	12.2
38.0	16.8	17.0		17.3	17.5	17.6	18.1	18.0	17.9	14.8	14.3	14.0	11.8	11.6	11.5
40.0	15.1	15.2		15.6	15.8	15.8	16.4	16.5	16.6	14.3	13.9	13.7	11.0	10.9	10.8
42.0	12.2	12.4		14.1	14.2		14.8	15.0	15.0	13.9	13.5	13.3	10.4	10.2	10.2
44.0	3.8			12.7	12.8		13.5	13.6	13.6	13.5	13.2	13.1	9.7	9.6	9.6
46.0				11.5	11.5		12.2	12.3		12.8	12.9	12.8	9.2	9.1	9.1
48.0				7.4			11.1	11.2		11.7	11.8	11.8	8.7	8.6	8.6
50.0							10.0	10.1		10.7	10.8		8.2	8.1	8.1
54.0							2.5			8.8	8.9		7.1	7.2	
58.0										4.9			6.1	6.2	
62.0													4.4	4.4	

Tragfähigkeiten
Lifting capacities
Capacités de levage
Capacidades de elevación



	40.4 m + 2.0 m + 3.5 m			45.4 m + 2.0 m + 3.5 m			50.5 m + 2.0 m + 3.5 m			55.6 m + 2.0 m + 3.5 m			60.0 m + 2.0 m + 3.5 m		
	0°	20°	40°	0°	20°	40°	0°	20°	40°	0°	20°	40°	0°	20°	40°
8.0	58.6														
9.0	58.6	58.6		52.9											
10.0	58.6	58.6	53.9	52.5	48.8		35.2								
11.0	58.6	57.7	52.9	51.2	47.7	45.5	34.0	30.6			28.6				
12.0	54.8	56.2	51.9	50.0	46.7	44.6	32.9	29.7	27.6	27.6	25.4		26.2		
14.0	44.7	45.8	46.8	43.7	44.8	42.9	30.9	28.1	26.3	25.8	23.8	22.6	24.6	22.8	21.6
16.0	37.1	38.1	38.8	36.5	37.4	38.2	29.2	26.7	25.1	24.2	22.5	21.4	23.1	21.5	20.5
18.0	31.2	32.0	32.7	30.8	31.6	32.2	27.7	25.4	24.1	22.8	21.3	20.3	21.8	20.4	19.5
20.0	26.3	27.1	27.6	26.1	26.8	27.4	26.2	24.3	23.2	21.5	20.2	19.4	20.6	19.4	18.6
22.0	22.4	23.1	23.5	22.4	23.0	23.4	22.6	23.2	22.3	20.4	19.3	18.5	19.6	18.5	17.8
24.0	18.9	19.4	19.7	19.2	19.8	20.1	19.5	20.1	20.4	19.5	18.4	17.8	18.7	17.7	17.1
26.0	15.8	16.3	16.5	16.3	16.8	17.1	17.0	17.4	17.7	17.2	17.6	17.1	16.9	16.9	16.4
28.0	13.3	13.7	13.9	13.8	14.2	14.5	14.6	15.0	15.3	15.0	15.5	15.7	14.8	15.2	15.5
30.0	11.2	11.5	11.6	11.7	12.0	12.2	12.5	12.8	13.1	13.2	13.5	13.8	12.9	13.3	13.5
32.0	9.3	9.6	9.7	9.8	10.1	10.3	10.6	11.0	11.1	11.3	11.7	11.9	11.3	11.6	11.9
34.0	7.8	8.0	8.0	8.3	8.5	8.6	9.0	9.3	9.5	9.7	10.0	10.2	9.9	10.2	10.4
36.0	6.4	6.6	6.6	6.9	7.1	7.2	7.6	7.9	8.0	8.3	8.6	8.7	8.5	8.7	8.9
38.0	5.2	5.3		5.7	5.9	5.9	6.4	6.6	6.7	7.1	7.3	7.4	7.2	7.5	7.6
40.0	4.1	4.2		4.6	4.7	4.8	5.3	5.5	5.6	6.0	6.2	6.3	6.1	6.4	6.5
42.0	3.1	3.1		3.6	3.7		4.4	4.5	4.6	5.0	5.2	5.3	5.1	5.3	5.4
44.0		2.2		2.8	2.8		3.5	3.6	3.6	4.1	4.3	4.4	4.3	4.4	4.5
46.0				2.0	2.0		2.7	2.8		3.3	3.5	3.5	3.5	3.6	3.7
48.0							2.0	2.1		2.6	2.7	2.8	2.7	2.9	2.9
50.0										2.0	2.1		2.1	2.2	2.2

SALE & RENT



UNIVERSAL
SALE & RENTAL

Hubhöhen
Lifting heights
Hauteurs de levage
Alturas de elevación







DIN/ISO/EN

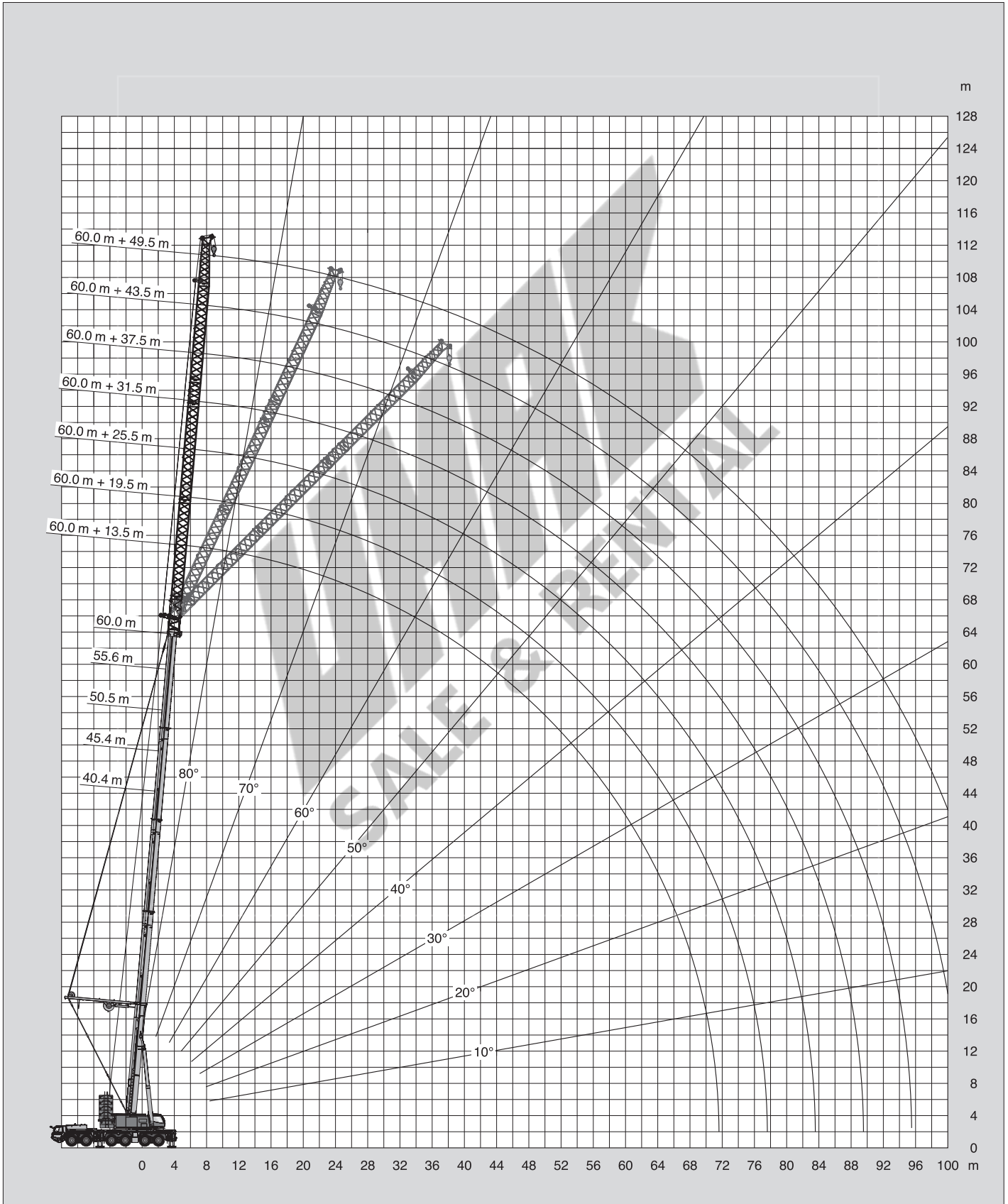

						138t	DIN/ISO/EN
--	--	--	--	--	--	-------------	-------------------

	40.4 m + 2.0 m + 11.5 m			45.4 m + 2.0 m + 11.5 m			50.5 m + 2.0 m + 11.5 m			55.6 m + 2.0 m + 11.5 m			60.0 m + 2.0 m + 11.5 m		
	0°	20°	40°	0°	20°	40°	0°	20°	40°	0°	20°	40°	0°	20°	40°
9.0	45.4														
10.0	45.4			36.6											
11.0	45.4			36.6			29.4								
12.0	44.8			36.6			28.2			22.4					
14.0	42.2	32.1		36.6	30.8		26.1			22.4			19.5		
16.0	39.8	30.6	25.7	36.6	29.6		24.2	19.2		20.9	17.1		19.5		
18.0	37.6	29.3	24.9	36.1	28.4	24.2	22.7	18.2	15.6	19.5	16.2		18.6	15.5	
20.0	35.3	28.1	24.1	33.9	27.4	23.5	21.3	17.3	15.0	18.3	15.3	13.6	17.5	14.7	
22.0	32.0	27.1	23.4	30.6	26.4	22.8	20.1	16.5	14.5	17.2	14.6	13.0	16.5	14.0	12.5
24.0	29.2	26.1	22.8	27.9	25.6	22.3	19.0	15.8	14.0	16.2	13.9	12.5	15.6	13.4	12.0
26.0	26.7	25.3	22.3	25.5	24.1	21.8	18.1	15.2	13.5	15.4	13.3	12.0	14.8	12.8	11.6
28.0	24.6	23.5	21.8	23.5	22.3	21.3	17.2	14.6	13.1	14.6	12.7	11.5	14.0	12.2	11.1
30.0	22.7	21.8	21.3	21.7	20.7	20.2	16.4	14.0	12.7	13.9	12.2	11.1	13.1	11.7	10.7
32.0	21.1	20.3	19.9	20.1	19.3	18.9	15.8	13.6	12.3	13.3	11.7	10.8	12.1	11.2	10.4
34.0	19.6	19.0	18.7	18.6	18.0	17.6	15.1	13.1	12.0	12.7	11.2	10.4	11.2	10.5	10.0
36.0	18.3	17.8	17.5	17.4	16.8	16.5	14.5	12.7	11.7	12.1	10.8	10.1	10.4	9.8	9.5
38.0	17.1	16.7	16.5	16.2	15.8	15.6	14.0	12.3	11.4	11.6	10.5	9.8	9.7	9.2	8.9
40.0	16.0	15.7	15.5	15.1	14.8	14.6	13.5	12.0	11.2	11.2	10.1	9.5	9.0	8.6	8.4
42.0	15.0	14.8	14.7	14.2	13.9	13.8	13.1	11.7	10.9	10.8	9.8	9.2	8.4	8.1	7.9
44.0	14.1	13.9	13.9	13.3	13.1	13.0	12.7	11.4	10.7	10.4	9.5	9.0	7.9	7.6	7.4
46.0	13.3	13.1		12.5	12.3	12.3	12.2	11.1	10.6	10.1	9.2	8.8	7.4	7.1	7.0
48.0	11.4	12.4		11.8	11.6	11.6	11.5	10.9	10.4	9.7	9.0	8.6	6.9	6.7	6.6
50.0	8.3	9.8		11.1	11.0		10.8	10.6	10.3	9.4	8.7	8.4	6.5	6.3	6.3
54.0				8.0	9.2		9.6	9.5		8.9	8.3	8.1	5.7	5.6	5.6
58.0							7.5	8.5		8.4	8.0	7.9	5.1	5.0	5.1
62.0										7.1	7.5		4.5	4.5	4.6
66.0										2.7	3.7		4.0	4.0	
70.0													2.3	3.2	

						138t	DIN/ISO/EN
--	--	--	--	--	--	-------------	-------------------

	40.4 m + 2.0 m + 17.5 m			45.4 m + 2.0 m + 17.5 m			50.5 m + 2.0 m + 17.5 m			55.6 m + 2.0 m + 17.5 m			60.0 m + 2.0 m + 17.5 m		
	0°	20°	40°	0°	20°	40°	0°	20°	40°	0°	20°	40°	0°	20°	40°
10.0	32.6														
11.0	32.6			28.2											
12.0	32.6			28.2			21.6								
14.0	32.6			28.2			21.6			16.8					
16.0	31.2	23.3		28.2			21.3			16.8			14.4		
18.0	29.4	22.2		28.1	21.4		19.8	15.0		16.8			14.0		
20.0	27.9	21.3		26.9	20.6		18.5	14.3		16.0	12.8		13.6		
22.0	26.5	20.4	17.1	25.6	19.8		17.4	13.6		15.0	12.2		13.1	11.8	
24.0	25.2	19.6	16.6	24.5	19.1	16.2	16.4	13.0	11.1	14.1	11.6		12.7	11.2	
26.0	24.0	18.9	16.2	23.2	18.5	15.8	15.5	12.4	10.7	13.4	11.0	9.7	12.1	10.7	9.4
28.0	22.4	18.2	15.8	21.3	17.9	15.4	14.7	11.9	10.3	12.6	10.5	9.3	11.6	10.2	9.0
30.0	20.7	17.7	15.4	19.7	17.4	15.1	14.0	11.4	10.0	12.0	10.1	9.0	11.1	9.8	8.7
32.0	19.2	17.1	15.0	18.2	16.9	14.7	13.3	11.0	9.7	11.4	9.7	8.7	10.6	9.4	8.4
34.0	17.8	16.6	14.7	16.9	16.1	14.4	12.7	10.6	9.4	10.9	9.3	8.4	9.8	9.0	8.0
36.0	16.6	16.0	14.5	15.8	15.1	14.2	12.2	10.2	9.2	10.4	8.9	8.1	9.1	8.4	7.6
38.0	15.5	15.0	14.2	14.7	14.2	13.9	11.7	9.9	8.9	9.9	8.6	7.8	8.4	7.8	7.3
40.0	14.5	14.1	13.9	13.7	13.3	13.1	11.2	9.6	8.7	9.5	8.3	7.6	7.8	7.3	7.0
42.0	13.6	13.3	13.2	12.8	12.5	12.4	10.8	9.3	8.5	9.1	8.0	7.4	7.3	6.9	6.7
44.0	12.8	12.5	12.5	12.0	11.8	11.6	10.4	9.0	8.3	8.8	7.7	7.2	6.7	6.4	6.3
46.0	12.0	11.8	11.8	11.3	11.1	11.0	10.1	8.8	8.1	8.4	7.5	7.0	6.3	6.0	5.9
48.0	11.3	11.2	11.1	10.6	10.4	10.4	9.8	8.6	8.0	8.1	7.3	6.8	5.9	5.6	5.6
50.0	10.7	10.6	10.6	10.0	9.9	9.8	9.5	8.4	7.8	7.9	7.0	6.6	5.5	5.3	5.3
54.0	9.0	9.5		8.9	8.8	8.8	8.6	8.0	7.6	7.4	6.7	6.3	4.8	4.7	4.7
58.0				7.9	7.9		7.7	7.6	7.5	6.9	6.3	6.1	4.2	4.1	4.2
62.0				3.2	4.8		6.8	6.8		6.5	6.1	5.9	3.6	3.6	3.7
66.0							3.8	5.2		5.9	5.8		3.2	3.2	3.3
70.0										3.9	5.1		2.8	2.8	
74.0													2.5	2.5	

MB
+FJ+PS

Tragfähigkeiten
 Lifting capacities
 Capacités de levage
 Capacidades de elevación



 ---> m	40.4 m + 2.0 m + 23.5 m			45.4 m + 2.0 m + 23.5 m			50.5 m + 2.0 m + 23.5 m			55.6 m + 2.0 m + 23.5 m			60.0 m + 2.0 m + 23.5 m		
	0°	20°	40°	0°	20°	40°	0°	20°	40°	0°	20°	40°	0°	20°	40°
11.0	24.7														
12.0	24.7														
14.0	24.7			21.4			16.6								
16.0	24.7			21.4			16.6			12.7			10.8		
18.0	24.3			21.4			16.6			12.7			10.4		
20.0	23.0	16.2		21.4			16.3			12.7			10.0		
22.0	21.7	15.5		21.1	15.5		15.2	11.5		12.7			9.6		
24.0	20.6	14.8		20.1	14.8		14.3	10.9		12.6	9.9		9.2		
26.0	19.6	14.1	11.3	19.2	14.3		13.5	10.4		11.8	9.4		8.8	9.1	
28.0	18.7	13.6	11.0	18.4	13.7	11.0	12.7	10.0		11.1	9.0		8.3	8.7	
30.0	17.7	13.1	10.7	17.7	13.2	10.7	12.1	9.6	8.2	10.5	8.6	7.5	7.9	8.2	
32.0	16.8	12.6	10.4	16.7	12.8	10.5	11.5	9.2	7.9	10.0	8.2	7.2	7.4	7.7	6.5
34.0	15.9	12.1	10.2	15.5	12.3	10.2	10.9	8.8	7.6	9.5	7.9	6.9	7.0	7.3	6.2
36.0	15.2	11.7	9.9	14.4	11.9	10.0	10.4	8.5	7.4	9.0	7.6	6.7	6.6	6.8	5.9
38.0	14.2	11.3	9.7	13.4	11.6	9.8	10.0	8.2	7.2	8.6	7.3	6.5	6.1	6.5	5.7
40.0	13.3	11.0	9.5	12.5	11.2	9.6	9.6	7.9	7.0	8.2	7.0	6.3	5.8	6.1	5.4
42.0	12.5	10.7	9.4	11.7	10.9	9.4	9.2	7.7	6.8	7.9	6.7	6.1	5.4	5.8	5.1
44.0	11.7	10.4	9.2	11.0	10.6	9.3	8.8	7.4	6.6	7.5	6.5	5.9	5.0	5.5	4.9
46.0	11.0	10.1	9.1	10.3	10.0	9.1	8.5	7.2	6.5	7.2	6.2	5.7	4.7	5.1	4.7
48.0	10.3	9.9	9.0	9.6	9.4	9.0	8.2	7.0	6.3	6.9	6.0	5.5	4.4	4.8	4.5
50.0	9.7	9.6	8.9	9.1	8.9	8.9	7.9	6.8	6.2	6.7	5.8	5.4	4.1	4.4	4.3
54.0	8.7	8.5	8.6	8.0	7.9	7.9	7.4	6.4	5.9	6.2	5.5	5.1	3.5	3.9	3.9
58.0	7.7	7.7	7.7	7.1	7.0	7.1	6.8	6.1	5.7	5.8	5.1	4.8	3.0	3.4	3.4
62.0	4.7	6.8		6.3	6.3	6.3	6.0	5.9	5.6	5.3	4.8	4.5	2.5	2.9	3.0
66.0				4.6	5.6		5.3	5.3	5.3	4.9	4.5	4.3	2.1	2.5	2.6
70.0							4.3	4.7		4.5	4.2	4.1	1.8	2.1	2.3
74.0										3.9	3.9		1.5	1.8	1.9
78.0											2.2			1.6	

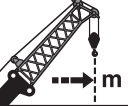

 ---> m	40.4 m + 2.0 m + 29.5 m			45.4 m + 2.0 m + 29.5 m			50.5 m + 2.0 m + 29.5 m			55.6 m + 2.0 m + 29.5 m			60.0 m + 2.0 m + 29.5 m		
	0°	20°	40°	0°	20°	40°	0°	20°	40°	0°	20°	40°	0°	20°	40°
12.0	18.6														
14.0	18.6			16.1											
16.0	18.6			16.1			12.4			8.6					
18.0	18.6			16.1			12.4			8.6			7.0		
20.0	18.6			16.1			12.4			8.6			6.7		
22.0	17.8			16.1			12.4			8.6			6.3		
24.0	16.7	11.5		16.1	11.5		12.4			8.6			6.0		
26.0	15.7	11.0		15.7	11.0		11.9	9.0		8.6			5.6		
28.0	14.8	10.5		15.1	10.6		11.2	8.6		8.4	8.1		5.3		
30.0	14.0	10.1		14.4	10.2		10.6	8.2		8.3	7.7		4.9	6.7	
32.0	13.2	9.7	7.8	13.7	9.8	7.8	10.1	7.9		8.1	7.3		4.6	6.3	
34.0	12.5	9.3	7.6	13.0	9.4	7.6	9.6	7.5	6.4	7.9	7.0		4.2	5.9	
36.0	11.9	9.0	7.4	12.4	9.1	7.4	9.1	7.2	6.2	7.7	6.7	5.8	3.9	5.5	
38.0	11.4	8.7	7.2	11.8	8.8	7.2	8.7	7.0	6.0	7.5	6.4	5.6	3.5	5.2	4.4
40.0	10.9	8.4	7.0	11.3	8.5	7.1	8.3	6.7	5.8	7.3	6.2	5.4	3.2	4.9	4.2
42.0	10.4	8.1	6.9	10.6	8.2	6.9	7.9	6.5	5.6	7.1	5.9	5.2	2.9	4.6	4.0
44.0	9.9	7.8	6.7	9.9	8.0	6.8	7.6	6.2	5.4	6.8	5.7	5.0	2.6	4.3	3.8
46.0	9.5	7.6	6.6	9.3	7.8	6.6	7.3	6.0	5.3	6.5	5.5	4.8	2.3	4.1	3.6
48.0	9.2	7.4	6.5	8.7	7.5	6.5	7.0	5.8	5.1	6.2	5.2	4.6	2.1	3.9	3.4
50.0	8.8	7.2	6.4	8.1	7.4	6.4	6.7	5.6	5.0	5.9	5.0	4.4	1.8	3.6	3.3
54.0	7.8	6.8	6.2	7.1	7.0	6.2	6.2	5.3	4.7	5.3	4.5	4.0	3.2	3.0	
58.0	6.9	6.5	6.1	6.3	6.3	6.1	5.8	5.0	4.5	4.8	4.1	3.7	2.7	2.7	
62.0	6.1	6.1	6.1	5.5	5.5	5.6	5.2	4.7	4.2	4.3	3.8	3.4	2.3	2.4	
66.0	5.3	5.4		4.9	4.9	4.9	4.6	4.4	4.1	3.9	3.4	3.2	1.9	2.0	
70.0				4.3	4.3		4.0	4.0	4.0	3.6	3.2	3.0	1.6	1.7	
74.0							3.5	3.5	3.5	3.1	2.9	2.8			
78.0										2.7	2.8	2.7			
82.0										1.8	2.4				

 m	40.4 m + 2.0 m + 35.5 m			45.4 m + 2.0 m + 35.5 m			50.5 m + 2.0 m + 35.5 m			55.6 m + 2.0 m + 35.5 m			60.0 m + 2.0 m + 35.5 m		
	0°	20°	40°	0°	20°	40°	0°	20°	40°	0°	20°	40°	0°	20°	40°
14.0	14.1														
16.0	14.1			12.2											
18.0	14.1			12.2			8.8			6.1					
20.0	14.1			12.2			8.8			6.1			4.4		
22.0	14.1			12.2			8.8			6.1			4.2		
24.0	13.9			12.2			8.8			6.1			3.8		
26.0	13.0	9.0		12.2			8.8			6.0			3.5		
28.0	12.2	8.6		12.2	8.6		8.8			5.8			3.2		
30.0	11.6	8.2		11.8	8.2		8.8	7.5		5.7			2.9		
32.0	10.9	7.8		11.2	7.9		8.8	7.1		5.5	6.5		2.6	5.4	
34.0	10.3	7.5		10.6	7.6		8.8	6.8		5.3	6.2		2.2	5.0	
36.0	9.8	7.2	5.8	10.1	7.3		8.4	6.5		5.2	5.9		1.9	4.7	
38.0	9.3	6.9	5.6	9.7	7.0	5.6	8.0	6.3		5.0	5.7		1.6	4.4	
40.0	8.9	6.7	5.5	9.2	6.8	5.5	7.6	6.0	5.1	4.8	5.4			4.1	
42.0	8.5	6.4	5.3	8.8	6.5	5.3	7.2	5.8	4.9	4.6	5.1	4.4		3.9	3.3
44.0	8.1	6.2	5.2	8.4	6.3	5.2	6.9	5.6	4.7	4.3	4.9	4.2		3.6	3.1
46.0	7.8	6.0	5.0	8.1	6.1	5.1	6.6	5.4	4.6	4.1	4.6	4.0		3.4	2.9
48.0	7.4	5.8	4.9	7.7	5.9	4.9	6.3	5.2	4.4	3.9	4.3	3.8		3.2	2.7
50.0	7.1	5.6	4.8	7.4	5.7	4.8	6.1	5.0	4.2	3.7	4.1	3.6		3.0	2.6
54.0	6.6	5.3	4.6	6.6	5.4	4.6	5.6	4.5	3.9	3.2	3.7	3.2		2.6	2.3
58.0	6.1	5.0	4.5	5.7	5.1	4.5	5.1	4.2	3.6	2.7	3.3	2.9		2.3	2.0
62.0	5.6	4.8	4.4	5.0	4.9	4.4	4.7	3.8	3.4	2.3	3.0	2.6		1.9	1.8
66.0	5.0	4.6	4.3	4.4	4.4	4.3	4.2	3.6	3.2	1.8	2.7	2.4			1.6
70.0	4.4	4.4	4.3	3.8	3.9	3.9	3.6	3.3	3.0		2.4	2.2			
74.0	2.2	3.9		3.3	3.4	3.4	3.1	3.1	2.9		2.2	2.0			
78.0				2.1	2.9		2.6	2.7	2.7		2.0	1.8			
82.0							2.2	2.3			1.8	1.7			
86.0											1.6				

 m	40.4 m + 2.0 m + 41.5 m			45.4 m + 2.0 m + 41.5 m			50.5 m + 2.0 m + 41.5 m			55.6 m + 2.0 m + 41.5 m			60.0 m + 2.0 m + 41.5 m		
	0°	20°	40°	0°	20°	40°	0°	20°	40°	0°	20°	40°	0°	20°	40°
16.0	10.1			8.6											
18.0	10.1			8.6			6.0								
20.0	10.1			8.6			6.0			3.5					
22.0	10.1			8.6			6.0			3.5			1.9		
24.0	10.1			8.6			6.0			3.5			1.6		
26.0	10.1			8.6			6.0			3.4					
28.0	10.1			8.6			6.0			3.2					
30.0	9.5	6.5		8.6			6.0			3.1					
32.0	9.0	6.2		8.6	6.2		6.0			2.9					
34.0	8.4	5.9		8.6	5.9		6.0	5.9		2.8					
36.0	8.0	5.7		8.2	5.7		6.0	5.6		2.6	4.8			3.1	
38.0	7.6	5.4		7.8	5.5		6.0	5.3		2.4	4.6			3.1	
40.0	7.2	5.2		7.4	5.2		6.0	5.0		2.2	4.3			3.1	
42.0	6.8	5.0	3.9	7.0	5.0		6.0	4.7		2.0	4.0			2.9	
44.0	6.5	4.8	3.7	6.7	4.8	3.7	6.0	4.4		1.8	3.7			2.7	
46.0	6.1	4.6	3.6	6.4	4.6	3.6	5.6	4.2	3.3	1.6	3.5			2.5	
48.0	5.9	4.4	3.5	6.1	4.5	3.5	5.3	4.0	3.2		3.2	2.7		2.3	1.9
50.0	5.6	4.2	3.3	5.8	4.3	3.4	5.0	3.7	3.0		3.0	2.5		2.1	1.7
54.0	5.1	3.9	3.1	5.3	4.0	3.2	4.4	3.3	2.7		2.6	2.2		1.7	
58.0	4.7	3.6	2.9	4.9	3.7	3.0	3.9	3.0	2.4		2.3	1.9			
62.0	4.3	3.3	2.8	4.2	3.5	2.8	3.5	2.7	2.2		1.9	1.6			
66.0	4.0	3.1	2.7	3.6	3.2	2.7	3.1	2.4	2.0		1.6				
70.0	3.6	2.9	2.6	3.1	3.0	2.6	2.7	2.1	1.8						
74.0	3.1	2.8	2.6	2.6	2.7	2.5	2.3	1.9	1.6						
78.0	2.7	2.7		2.1	2.2	2.3	1.8	1.7	1.5						
82.0				1.7	1.8	1.8									
86.0															

MB
+FJ+PS

Tragfähigkeiten
Lifting capacities
Capacités de levage
Capacidades de elevación



	40.4 m + 2.0 m + 47.5 m			45.4 m + 2.0 m + 47.5 m			50.5 m + 2.0 m + 47.5 m								
	0°	20°	40°	0°	20°	40°	0°	20°	40°						
16.0	6.7														
18.0	6.7			5.6											
20.0	6.7			5.6			3.3								
22.0	6.7			5.6			3.3								
24.0	6.7			5.6			3.3								
26.0	6.7			5.6			3.3								
28.0	6.7			5.6			3.3								
30.0	6.7			5.6			3.3								
32.0	6.7			5.6			3.3								
34.0	6.6	4.5		5.6			3.3								
36.0	6.2	4.3		5.6	4.2		3.3								
38.0	5.8	4.1		5.6	4.0		3.3	3.9							
40.0	5.5	3.9		5.6	3.8		3.3	3.7							
42.0	5.2	3.7		5.3	3.7		3.3	3.6							
44.0	4.9	3.5		5.0	3.5		3.3	3.4							
46.0	4.7	3.3		4.8	3.3		3.3	3.2							
48.0	4.4	3.1	2.2	4.6	3.2		3.3	3.0							
50.0	4.2	3.0	2.1	4.3	3.0	2.1	3.3	2.8							
54.0	3.8	2.6	1.9	3.9	2.7	1.9	3.3	2.4	1.8						
58.0	3.4	2.4	1.7	3.6	2.5	1.7	2.9	2.0	1.5						
62.0	3.1	2.1	1.5	3.3	2.2	1.6	2.5	1.7							
66.0	2.7	1.9		2.9	2.0		2.2	1.5							
70.0	2.4	1.7		2.4	1.8		1.8								
74.0	2.1	1.5		2.0	1.6		1.5								
78.0	1.9			1.5	1.5										
82.0	1.6														

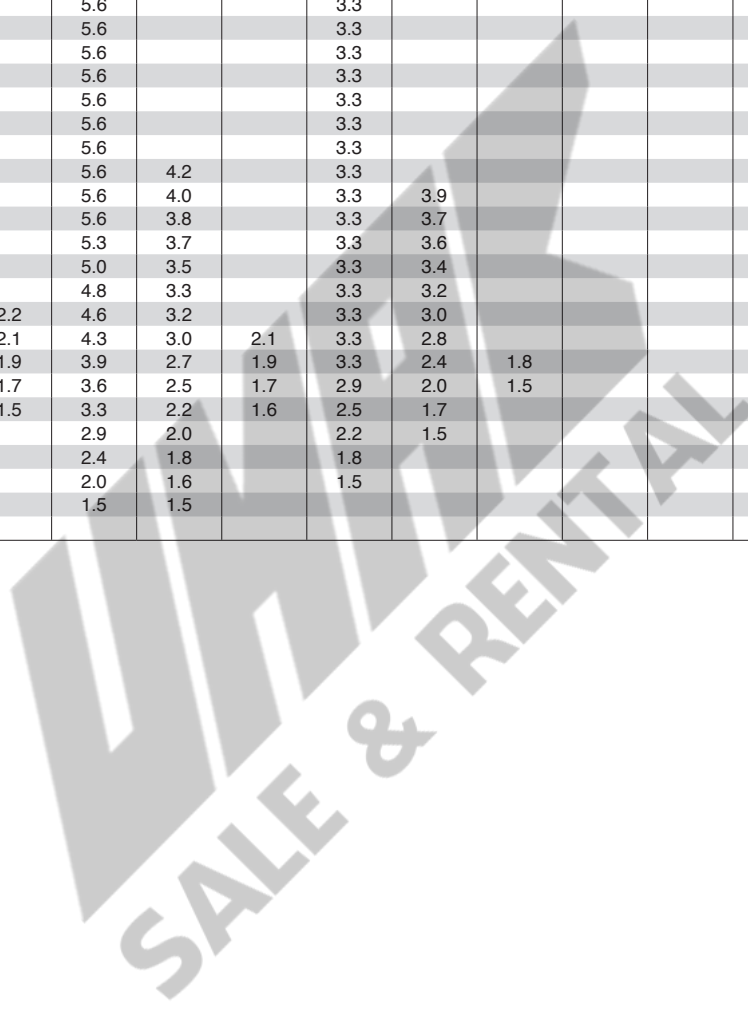

m	40.4 m + 2.0 m + 11.5 m			45.4 m + 2.0 m + 11.5 m			50.5 m + 2.0 m + 11.5 m			55.6 m + 2.0 m + 11.5 m			60.0 m + 2.0 m + 11.5 m		
	0°	20°	40°	0°	20°	40°	0°	20°	40°	0°	20°	40°	0°	20°	40°
9.0	45.4														
10.0	45.4			36.6											
11.0	45.4			36.6			29.4								
12.0	44.8			36.6			28.2			22.4					
14.0	42.2	32.1		36.6	30.8		26.1			22.4			19.5		
16.0	39.8	30.6	25.7	36.6	29.6		24.2	19.2		20.9	17.1		19.5		
18.0	37.6	29.3	24.9	36.1	28.4	24.2	22.7	18.2	15.6	19.5	16.2		18.6	15.5	
20.0	35.3	28.1	24.1	33.9	27.4	23.5	21.3	17.3	15.0	18.3	15.3	13.6	17.5	14.7	
22.0	32.0	27.1	23.4	30.6	26.4	22.8	20.1	16.5	14.5	17.2	14.6	13.0	16.5	14.0	12.5
24.0	29.2	26.1	22.8	27.9	25.6	22.3	19.0	15.8	14.0	16.2	13.9	12.5	15.6	13.4	12.0
26.0	26.7	25.3	22.3	25.5	24.1	21.8	18.1	15.2	13.5	15.4	13.3	12.0	14.8	12.8	11.6
28.0	24.6	23.5	21.8	23.5	22.3	21.3	17.2	14.6	13.1	14.6	12.7	11.5	14.0	12.2	11.1
30.0	22.7	21.8	21.3	21.7	20.7	20.2	16.4	14.0	12.7	13.9	12.2	11.1	13.1	11.7	10.7
32.0	21.1	20.3	19.9	20.1	19.3	18.9	15.8	13.6	12.3	13.3	11.7	10.8	12.1	11.2	10.4
34.0	19.6	19.0	18.7	18.6	18.0	17.6	15.1	13.1	12.0	12.7	11.2	10.4	11.2	10.5	10.0
36.0	18.3	17.8	17.5	17.4	16.8	16.5	14.5	12.7	11.7	12.1	10.8	10.1	10.4	9.8	9.5
38.0	17.1	16.7	16.5	16.2	15.8	15.6	14.0	12.3	11.4	11.6	10.5	9.8	9.7	9.2	8.9
40.0	16.0	15.7	15.5	15.1	14.8	14.6	13.5	12.0	11.2	11.2	10.1	9.5	9.0	8.6	8.4
42.0	14.7	14.8	14.7	14.2	13.9	13.8	13.1	11.7	10.9	10.8	9.8	9.2	8.4	8.1	7.9
44.0	13.4	13.9	13.9	13.3	13.1	13.0	12.7	11.4	10.7	10.4	9.5	9.0	7.9	7.6	7.4
46.0	12.1	12.6		12.4	12.3	12.3	12.2	11.1	10.6	10.1	9.2	8.8	7.4	7.1	7.0
48.0	11.0	11.4		11.3	11.6	11.6	11.5	10.9	10.4	9.7	9.0	8.6	6.9	6.7	6.6
50.0	8.3	9.8		10.3	10.7		10.7	10.6	10.3	9.4	8.7	8.4	6.5	6.3	6.3
54.0				8.0	8.7		8.9	9.2		8.9	8.3	8.1	5.7	5.6	5.6
58.0							7.3	7.5		7.7	8.0	7.9	5.1	5.0	5.1
62.0										6.4	6.6		4.5	4.5	4.6
66.0										2.7	3.7		4.0	4.0	
70.0													2.3	3.2	

m	40.4 m + 2.0 m + 17.5 m			45.4 m + 2.0 m + 17.5 m			50.5 m + 2.0 m + 17.5 m			55.6 m + 2.0 m + 17.5 m			60.0 m + 2.0 m + 17.5 m		
	0°	20°	40°	0°	20°	40°	0°	20°	40°	0°	20°	40°	0°	20°	40°
10.0	32.6														
11.0	32.6			28.2											
12.0	32.6			28.2			21.6								
14.0	32.6			28.2			21.6			16.8					
16.0	31.2	23.3		28.2			21.3			16.8			14.4		
18.0	29.4	22.2		28.1	21.4		19.8	15.0		16.8			14.0		
20.0	27.9	21.3		26.9	20.6		18.5	14.3		16.0	12.8		13.6		
22.0	26.5	20.4	17.1	25.6	19.8		17.4	13.6		15.0	12.2		13.1	11.8	
24.0	25.2	19.6	16.6	24.5	19.1	16.2	16.4	13.0	11.1	14.1	11.6		12.7	11.2	
26.0	24.0	18.9	16.2	23.2	18.5	15.8	15.5	12.4	10.7	13.4	11.0	9.7	12.1	10.7	9.4
28.0	22.4	18.2	15.8	21.3	17.9	15.4	14.7	11.9	10.3	12.6	10.5	9.3	11.6	10.2	9.0
30.0	20.7	17.7	15.4	19.7	17.4	15.1	14.0	11.4	10.0	12.0	10.1	9.0	11.1	9.8	8.7
32.0	19.2	17.1	15.0	18.2	16.9	14.7	13.3	11.0	9.7	11.4	9.7	8.7	10.6	9.4	8.4
34.0	17.8	16.6	14.7	16.9	16.1	14.4	12.7	10.6	9.4	10.9	9.3	8.4	9.8	9.0	8.0
36.0	16.6	16.0	14.5	15.8	15.1	14.2	12.2	10.2	9.2	10.4	8.9	8.1	9.1	8.4	7.6
38.0	15.5	15.0	14.2	14.7	14.2	13.9	11.7	9.9	8.9	9.9	8.6	7.8	8.4	7.8	7.3
40.0	14.5	14.1	13.9	13.7	13.3	13.1	11.2	9.6	8.7	9.5	8.3	7.6	7.8	7.3	7.0
42.0	13.6	13.3	13.2	12.8	12.5	12.4	10.8	9.3	8.5	9.1	8.0	7.4	7.3	6.9	6.7
44.0	12.8	12.5	12.5	12.0	11.8	11.6	10.4	9.0	8.3	8.8	7.7	7.2	6.7	6.4	6.3
46.0	12.0	11.8	11.8	11.3	11.1	11.0	10.1	8.8	8.1	8.4	7.5	7.0	6.3	6.0	5.9
48.0	11.3	11.2	11.1	10.6	10.4	10.4	9.8	8.6	8.0	8.1	7.3	6.8	5.9	5.6	5.6
50.0	10.6	10.6	10.6	10.0	9.9	9.8	9.5	8.4	7.8	7.9	7.0	6.6	5.5	5.3	5.3
54.0	8.8	9.2		8.9	8.8	8.8	8.6	8.0	7.6	7.4	6.7	6.3	4.8	4.7	4.7
58.0				7.3	7.7		7.7	7.6	7.5	6.9	6.3	6.1	4.2	4.1	4.2
62.0				3.2	4.8		6.4	6.7		6.5	6.1	5.9	3.6	3.6	3.7
66.0							3.8	5.2		5.4	5.8		3.2	3.2	3.3
70.0										3.9	4.6		2.8	2.8	
74.0													2.5	2.5	

MB
+FJ+PS

Tragfähigkeiten
Lifting capacities
Capacités de levage
Capacidades de elevación

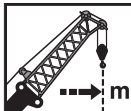

 m	40.4 m + 2.0 m + 23.5 m			45.4 m + 2.0 m + 23.5 m			50.5 m + 2.0 m + 23.5 m			55.6 m + 2.0 m + 23.5 m			60.0 m + 2.0 m + 23.5 m		
	0°	20°	40°	0°	20°	40°	0°	20°	40°	0°	20°	40°	0°	20°	40°
11.0	24.7														
12.0	24.7														
14.0	24.7			21.4			16.6								
16.0	24.7			21.4			16.6			12.7			10.8		
18.0	24.3			21.4			16.6			12.7			10.4		
20.0	23.0	16.2		21.4			16.3			12.7			10.0		
22.0	21.7	15.5		21.1	15.5		15.2	11.5		12.7			9.6		
24.0	20.6	14.8		20.1	14.8		14.3	10.9		12.6	9.9		9.2		
26.0	19.6	14.1	11.3	19.2	14.3		13.5	10.4		11.8	9.4		8.8	9.1	
28.0	18.7	13.6	11.0	18.4	13.7	11.0	12.7	10.0		11.1	9.0		8.3	8.7	
30.0	17.7	13.1	10.7	17.7	13.2	10.7	12.1	9.6	8.2	10.5	8.6	7.5	7.9	8.2	
32.0	16.8	12.6	10.4	16.7	12.8	10.5	11.5	9.2	7.9	10.0	8.2	7.2	7.4	7.7	6.5
34.0	15.9	12.1	10.2	15.5	12.3	10.2	10.9	8.8	7.6	9.5	7.9	6.9	7.0	7.3	6.2
36.0	15.2	11.7	9.9	14.4	11.9	10.0	10.4	8.5	7.4	9.0	7.6	6.7	6.6	6.8	5.9
38.0	14.2	11.3	9.7	13.4	11.6	9.8	10.0	8.2	7.2	8.6	7.3	6.5	6.1	6.5	5.7
40.0	13.3	11.0	9.5	12.5	11.2	9.6	9.6	7.9	7.0	8.2	7.0	6.3	5.8	6.1	5.4
42.0	12.5	10.7	9.4	11.7	10.9	9.4	9.2	7.7	6.8	7.9	6.7	6.1	5.4	5.8	5.1
44.0	11.7	10.4	9.2	11.0	10.6	9.3	8.8	7.4	6.6	7.5	6.5	5.9	5.0	5.5	4.9
46.0	11.0	10.1	9.1	10.3	10.0	9.1	8.5	7.2	6.5	7.2	6.2	5.7	4.7	5.1	4.7
48.0	10.3	9.9	9.0	9.6	9.4	9.0	8.2	7.0	6.3	6.9	6.0	5.5	4.4	4.8	4.5
50.0	9.7	9.6	8.9	9.1	8.9	8.9	7.9	6.8	6.2	6.7	5.8	5.4	4.1	4.4	4.3
54.0	8.7	8.5	8.6	8.0	7.9	7.9	7.4	6.4	5.9	6.2	5.5	5.1	3.5	3.9	3.9
58.0	7.7	7.7	7.7	7.1	7.0	7.1	6.8	6.1	5.7	5.8	5.1	4.8	3.0	3.4	3.4
62.0	4.7	6.7		6.3	6.3	6.3	6.0	5.9	5.6	5.3	4.8	4.5	2.5	2.9	3.0
66.0				4.6	5.5		5.3	5.3	5.3	4.9	4.5	4.3	2.1	2.5	2.6
70.0							4.3	4.7		4.5	4.2	4.1	1.8	2.1	2.3
74.0										3.6	3.9		1.5	1.8	1.9
78.0											2.2				1.6

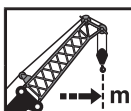

 m	40.4 m + 2.0 m + 29.5 m			45.4 m + 2.0 m + 29.5 m			50.5 m + 2.0 m + 29.5 m			55.6 m + 2.0 m + 29.5 m			60.0 m + 2.0 m + 29.5 m		
	0°	20°	40°	0°	20°	40°	0°	20°	40°	0°	20°	40°	0°	20°	40°
12.0	18.6														
14.0	18.6			16.1											
16.0	18.6			16.1			12.4			8.6					
18.0	18.6			16.1			12.4			8.6			7.0		
20.0	18.6			16.1			12.4			8.6			6.7		
22.0	17.8			16.1			12.4			8.6			6.3		
24.0	16.7	11.5		16.1	11.5		12.4			8.6			6.0		
26.0	15.7	11.0		15.7	11.0		11.9	9.0		8.6			5.6		
28.0	14.8	10.5		15.1	10.6		11.2	8.6		8.4	8.1		5.3		
30.0	14.0	10.1		14.4	10.2		10.6	8.2		8.3	7.7		4.9	6.7	
32.0	13.2	9.7	7.8	13.7	9.8	7.8	10.1	7.9		8.1	7.3		4.6	6.3	
34.0	12.5	9.3	7.6	13.0	9.4	7.6	9.6	7.5	6.4	7.9	7.0		4.2	5.9	
36.0	11.9	9.0	7.4	12.4	9.1	7.4	9.1	7.2	6.2	7.7	6.7	5.8	3.9	5.5	
38.0	11.4	8.7	7.2	11.8	8.8	7.2	8.7	7.0	6.0	7.5	6.4	5.6	3.5	5.2	4.4
40.0	10.9	8.4	7.0	11.3	8.5	7.1	8.3	6.7	5.8	7.3	6.2	5.4	3.2	4.9	4.2
42.0	10.4	8.1	6.9	10.6	8.2	6.9	7.9	6.5	5.6	7.1	5.9	5.2	2.9	4.6	4.0
44.0	9.9	7.8	6.7	9.9	8.0	6.8	7.6	6.2	5.4	6.8	5.7	5.0	2.6	4.3	3.8
46.0	9.5	7.6	6.6	9.3	7.8	6.6	7.3	6.0	5.3	6.5	5.5	4.8	2.3	4.1	3.6
48.0	9.2	7.4	6.5	8.7	7.5	6.5	7.0	5.8	5.1	6.2	5.2	4.6	2.1	3.9	3.4
50.0	8.8	7.2	6.4	8.1	7.4	6.4	6.7	5.6	5.0	5.9	5.0	4.4	1.8	3.6	3.3
54.0	7.8	6.8	6.2	7.1	7.0	6.2	6.2	5.3	4.7	5.3	4.5	4.0		3.2	3.0
58.0	6.9	6.5	6.1	6.3	6.3	6.1	5.8	5.0	4.5	4.8	4.1	3.7		2.7	2.7
62.0	6.1	6.1	6.1	5.5	5.5	5.6	5.2	4.7	4.2	4.3	3.8	3.4		2.3	2.4
66.0	5.3	5.4		4.9	4.9	4.9	4.6	4.4	4.1	3.9	3.4	3.2		1.9	2.0
70.0				4.3	4.3		4.0	4.0	4.0	3.6	3.2	3.0		1.6	1.7
74.0							3.5	3.5		3.1	2.9	2.8			
78.0										2.7	2.8				
82.0										1.8	2.4				



Lift Height (m)	40.4 m + 2.0 m + 35.5 m			45.4 m + 2.0 m + 35.5 m			50.5 m + 2.0 m + 35.5 m			55.6 m + 2.0 m + 35.5 m			60.0 m + 2.0 m + 35.5 m		
	0°	20°	40°	0°	20°	40°	0°	20°	40°	0°	20°	40°	0°	20°	40°
14.0	14.1														
16.0	14.1			12.2											
18.0	14.1			12.2			8.8			6.1					
20.0	14.1			12.2			8.8			6.1			4.4		
22.0	14.1			12.2			8.8			6.1			4.2		
24.0	13.9			12.2			8.8			6.1			3.8		
26.0	13.0	9.0		12.2			8.8			6.0			3.5		
28.0	12.2	8.6		12.2	8.6		8.8			5.8			3.2		
30.0	11.6	8.2		11.8	8.2		8.8	7.5		5.7			2.9		
32.0	10.9	7.8		11.2	7.9		8.8	7.1		5.5	6.5		2.6	5.4	
34.0	10.3	7.5		10.6	7.6		8.8	6.8		5.3	6.2		2.2	5.0	
36.0	9.8	7.2	5.8	10.1	7.3		8.4	6.5		5.2	5.9		1.9	4.7	
38.0	9.3	6.9	5.6	9.7	7.0	5.6	8.0	6.3		5.0	5.7		1.6	4.4	
40.0	8.9	6.7	5.5	9.2	6.8	5.5	7.6	6.0	5.1	4.8	5.4			4.1	
42.0	8.5	6.4	5.3	8.8	6.5	5.3	7.2	5.8	4.9	4.6	5.1	4.4		3.9	3.3
44.0	8.1	6.2	5.2	8.4	6.3	5.2	6.9	5.6	4.7	4.3	4.9	4.2		3.6	3.1
46.0	7.8	6.0	5.0	8.1	6.1	5.1	6.6	5.4	4.6	4.1	4.6	4.0		3.4	2.9
48.0	7.4	5.8	4.9	7.7	5.9	4.9	6.3	5.2	4.4	3.9	4.3	3.8		3.2	2.7
50.0	7.1	5.6	4.8	7.4	5.7	4.8	6.1	5.0	4.2	3.7	4.1	3.6		3.0	2.6
54.0	6.6	5.3	4.6	6.6	5.4	4.6	5.6	4.5	3.9	3.2	3.7	3.2		2.6	2.3
58.0	6.1	5.0	4.5	5.7	5.1	4.5	5.1	4.2	3.6	2.7	3.3	2.9		2.3	2.0
62.0	5.6	4.8	4.4	5.0	4.9	4.4	4.7	3.8	3.4	2.3	3.0	2.6		1.9	1.8
66.0	5.0	4.6	4.3	4.4	4.4	4.3	4.2	3.6	3.2	1.8	2.7	2.4			1.6
70.0	4.4	4.4	4.3	3.8	3.9	3.9	3.6	3.3	3.0		2.4	2.2			
74.0	2.2	3.9		3.3	3.4	3.4	3.1	3.1	2.9		2.2	2.0			
78.0				2.1	2.9		2.6	2.7	2.7		2.0	1.8			
82.0							2.2	2.3			1.8	1.7			
86.0											1.6				



Lift Height (m)	40.4 m + 2.0 m + 41.5 m			45.4 m + 2.0 m + 41.5 m			50.5 m + 2.0 m + 41.5 m			55.6 m + 2.0 m + 41.5 m			60.0 m + 2.0 m + 41.5 m		
	0°	20°	40°	0°	20°	40°	0°	20°	40°	0°	20°	40°	0°	20°	40°
16.0	10.1			8.6											
18.0	10.1			8.6			6.0								
20.0	10.1			8.6			6.0			3.5					
22.0	10.1			8.6			6.0			3.5			1.9		
24.0	10.1			8.6			6.0			3.5			1.6		
26.0	10.1			8.6			6.0			3.4					
28.0	10.1			8.6			6.0			3.2					
30.0	9.5	6.5		8.6			6.0			3.1					
32.0	9.0	6.2		8.6	6.2		6.0			2.9					
34.0	8.4	5.9		8.6	5.9		6.0	5.9		2.8					
36.0	8.0	5.7		8.2	5.7		6.0	5.6		2.6	4.8			3.1	
38.0	7.6	5.4		7.8	5.5		6.0	5.3		2.4	4.6			3.1	
40.0	7.2	5.2		7.4	5.2		6.0	5.0		2.2	4.3			3.1	
42.0	6.8	5.0	3.9	7.0	5.0		6.0	4.7		2.0	4.0			2.9	
44.0	6.5	4.8	3.7	6.7	4.8	3.7	6.0	4.4		1.8	3.7			2.7	
46.0	6.1	4.6	3.6	6.4	4.6	3.6	5.6	4.2	3.3	1.6	3.5			2.5	
48.0	5.9	4.4	3.5	6.1	4.5	3.5	5.3	4.0	3.2		3.2	2.7		2.3	1.9
50.0	5.6	4.2	3.3	5.8	4.3	3.4	5.0	3.7	3.0		3.0	2.5		2.1	1.7
54.0	5.1	3.9	3.1	5.3	4.0	3.2	4.4	3.3	2.7		2.6	2.2		1.7	
58.0	4.7	3.6	2.9	4.9	3.7	3.0	3.9	3.0	2.4		2.3	1.9			
62.0	4.3	3.3	2.8	4.2	3.5	2.8	3.5	2.7	2.2		1.9	1.6			
66.0	4.0	3.1	2.7	3.6	3.2	2.7	3.1	2.4	2.0		1.6				
70.0	3.6	2.9	2.6	3.1	3.0	2.6	2.7	2.1	1.8						
74.0	3.1	2.8	2.6	2.6	2.7	2.5	2.3	1.9	1.6						
78.0	2.7	2.7		2.1	2.2	2.3	1.8	1.7	1.5						
82.0				1.7	1.8	1.8		1.5							

MB
+ FJ + PS

Tragfähigkeiten
Lifting capacities
Capacités de levage
Capacidades de elevación



	40.4 m + 2.0 m + 47.5 m			45.4 m + 2.0 m + 47.5 m			50.5 m + 2.0 m + 47.5 m								
	0°	20°	40°	0°	20°	40°	0°	20°	40°						
16.0	6.7														
18.0	6.7			5.6											
20.0	6.7			5.6			3.3								
22.0	6.7			5.6			3.3								
24.0	6.7			5.6			3.3								
26.0	6.7			5.6			3.3								
28.0	6.7			5.6			3.3								
30.0	6.7			5.6			3.3								
32.0	6.7			5.6			3.3								
34.0	6.6	4.5		5.6			3.3								
36.0	6.2	4.3		5.6	4.2		3.3								
38.0	5.8	4.1		5.6	4.0		3.3	3.9							
40.0	5.5	3.9		5.6	3.8		3.3	3.7							
42.0	5.2	3.7		5.3	3.7		3.3	3.6							
44.0	4.9	3.5		5.0	3.5		3.3	3.4							
46.0	4.7	3.3		4.8	3.3		3.3	3.2							
48.0	4.4	3.1	2.2	4.6	3.2		3.3	3.0							
50.0	4.2	3.0	2.1	4.3	3.0	2.1	3.3	2.8							
54.0	3.8	2.6	1.9	3.9	2.7	1.9	3.3	2.4	1.8						
58.0	3.4	2.4	1.7	3.6	2.5	1.7	2.9	2.0	1.5						
62.0	3.1	2.1	1.5	3.3	2.2	1.6	2.5	1.7							
66.0	2.7	1.9		2.9	2.0		2.2	1.5							
70.0	2.4	1.7		2.4	1.8		1.8								
74.0	2.1	1.5		2.0	1.6		1.5								
78.0	1.9			1.5	1.5										
82.0	1.6														

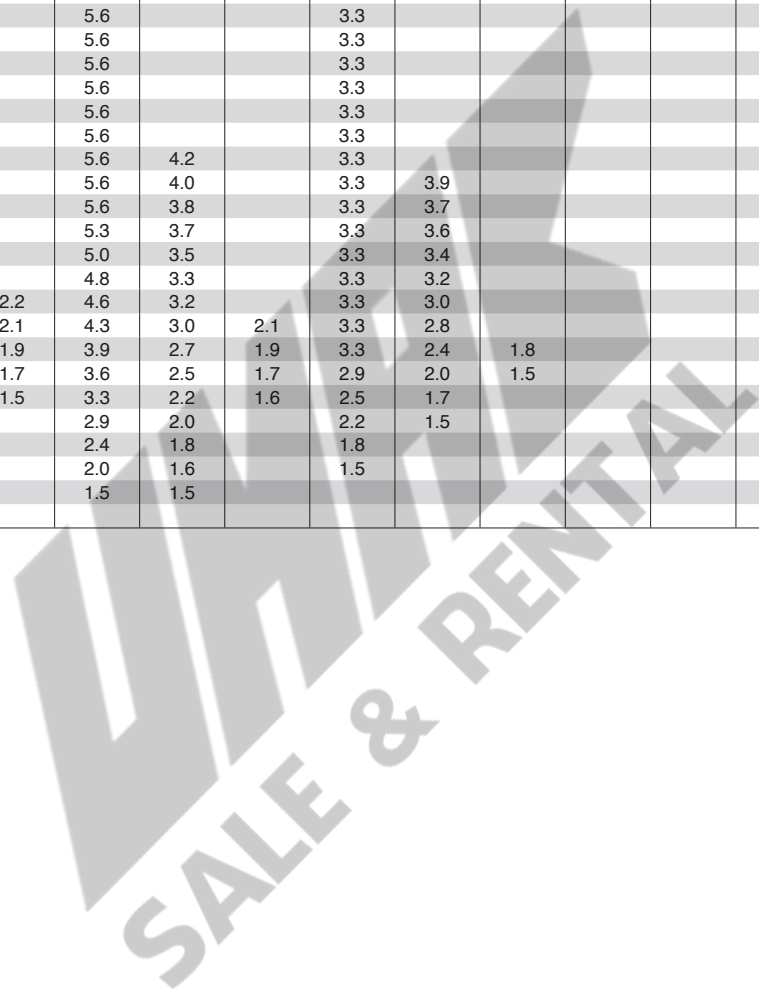

m	40.4 m + 2.0 m + 11.5 m			45.4 m + 2.0 m + 11.5 m			50.5 m + 2.0 m + 11.5 m			55.6 m + 2.0 m + 11.5 m			60.0 m + 2.0 m + 11.5 m		
	0°	20°	40°	0°	20°	40°	0°	20°	40°	0°	20°	40°	0°	20°	40°
9.0	45.4														
10.0	45.4			36.6											
11.0	45.4			36.6			29.4								
12.0	44.8			36.6			28.2				22.4				
14.0	42.2	32.1		36.6	30.8		26.1			22.4				19.5	
16.0	36.4	30.6	25.7	35.6	29.6		24.2	19.2		20.9	17.1			19.5	
18.0	30.9	29.3	24.9	30.3	28.4	24.2	22.7	18.2	15.6	19.5	16.2			18.6	15.5
20.0	26.3	28.1	24.1	25.9	27.4	23.5	21.3	17.3	15.0	18.3	15.3	13.6		17.5	14.7
22.0	22.6	24.8	23.4	22.3	24.4	22.8	20.1	16.5	14.5	17.2	14.6	13.0		16.5	14.0
24.0	19.6	21.5	22.8	19.4	21.2	22.3	19.0	15.8	14.0	16.2	13.9	12.5		15.6	13.4
26.0	17.0	18.7	20.1	16.8	18.5	19.9	16.9	15.2	13.5	15.4	13.3	12.0		14.8	12.8
28.0	14.5	16.0	17.2	14.7	16.2	17.4	14.8	14.6	13.1	14.6	12.7	11.5		14.0	12.2
30.0	12.3	13.7	14.7	12.7	14.1	15.1	12.9	14.0	12.7	13.1	12.2	11.1		12.7	11.7
32.0	10.5	11.7	12.6	10.8	12.1	13.0	11.3	12.5	12.3	11.5	11.7	10.8		11.1	11.2
34.0	8.9	10.0	10.8	9.2	10.4	11.2	9.7	10.8	11.7	10.1	11.2	10.4		9.7	10.5
36.0	7.5	8.5	9.2	7.9	8.9	9.6	8.3	9.3	10.1	8.8	9.8	10.1		8.5	9.6
38.0	6.3	7.2	7.7	6.6	7.6	8.2	7.1	8.0	8.7	7.6	8.5	9.2		7.4	8.4
40.0	5.2	6.0	6.4	5.6	6.4	6.9	6.0	6.8	7.4	6.5	7.3	8.0		6.4	7.3
42.0	4.3	4.9	5.3	4.6	5.3	5.8	5.0	5.8	6.3	5.5	6.3	6.8		5.4	6.2
44.0	3.4	4.0	4.2	3.7	4.4	4.7	4.1	4.8	5.3	4.6	5.3	5.8		4.5	5.3
46.0	2.7	3.1		2.9	3.5	3.8	3.4	4.0	4.4	3.8	4.5	4.9		3.7	4.4
48.0	2.0	2.3		2.2	2.7	2.9	2.6	3.2	3.5	3.1	3.7	4.1		3.0	3.7
50.0		1.5		1.6	2.0		2.0	2.5	2.7	2.4	3.0	3.3		2.3	2.9
54.0											1.7	1.9			2.0

m	40.4 m + 2.0 m + 17.5 m			45.4 m + 2.0 m + 17.5 m			50.5 m + 2.0 m + 17.5 m			55.6 m + 2.0 m + 17.5 m			60.0 m + 2.0 m + 17.5 m		
	0°	20°	40°	0°	20°	40°	0°	20°	40°	0°	20°	40°	0°	20°	40°
10.0	32.6														
11.0	32.6			28.2											
12.0	32.6			28.2			21.6								
14.0	32.6			28.2			21.6			16.8					
16.0	31.2	23.3		28.2			21.3			16.8				14.4	
18.0	29.4	22.2		28.1	21.4		19.8	15.0		16.8				14.0	
20.0	26.4	21.3		25.8	20.6		18.5	14.3		16.0	12.8			13.6	
22.0	22.8	20.4	17.1	22.3	19.8		17.4	13.6		15.0	12.2			13.1	11.8
24.0	19.8	19.6	16.6	19.4	19.1	16.2	16.4	13.0	11.1	14.1	11.6			12.7	11.2
26.0	17.3	18.9	16.2	16.9	18.5	15.8	15.5	12.4	10.7	13.4	11.0	9.7		12.1	10.7
28.0	15.1	17.3	15.8	14.8	17.0	15.4	14.7	11.9	10.3	12.6	10.5	9.3		11.6	10.2
30.0	13.1	15.2	15.4	13.0	15.0	15.1	13.0	11.4	10.0	12.0	10.1	9.0		11.1	9.8
32.0	11.3	13.1	14.6	11.4	13.2	14.7	11.4	11.0	9.7	11.4	9.7	8.7		10.6	9.4
34.0	9.7	11.4	12.7	9.8	11.5	12.9	10.0	10.6	9.4	10.1	9.3	8.4		9.7	9.0
36.0	8.3	9.8	11.0	8.4	9.9	11.2	8.8	10.2	9.2	8.9	8.9	8.1		8.5	8.4
38.0	7.0	8.4	9.5	7.1	8.6	9.7	7.6	9.0	8.9	7.8	8.6	7.8		7.4	7.8
40.0	6.0	7.2	8.1	6.0	7.4	8.3	6.5	7.8	8.7	6.7	8.1	7.6		6.4	7.3
42.0	5.0	6.1	6.9	5.1	6.3	7.1	5.5	6.7	7.6	5.7	7.0	7.4		5.5	6.8
44.0	4.1	5.1	5.8	4.2	5.3	6.0	4.6	5.7	6.5	4.9	6.0	6.9		4.7	5.9
46.0	3.3	4.2	4.7	3.4	4.4	5.0	3.8	4.8	5.6	4.1	5.1	5.9		3.9	5.0
48.0	2.6	3.4	3.8	2.7	3.6	4.1	3.1	4.0	4.7	3.3	4.3	5.0		3.2	4.2
50.0	2.0	2.6	2.9	2.0	2.8	3.3	2.4	3.3	3.8	2.7	3.6	4.2		2.5	3.5
54.0					1.5	1.7		2.0	2.4		2.3	2.7			2.2

MB
+FJ+PS

Tragfähigkeiten
Lifting capacities
Capacités de levage
Capacidades de elevación



	40.4 m + 2.0 m + 23.5 m			45.4 m + 2.0 m + 23.5 m			50.5 m + 2.0 m + 23.5 m			55.6 m + 2.0 m + 23.5 m			60.0 m + 2.0 m + 23.5 m		
	0°	20°	40°	0°	20°	40°	0°	20°	40°	0°	20°	40°	0°	20°	40°
11.0	24.7														
12.0	24.7														
14.0	24.7			21.4			16.6								
16.0	24.7			21.4			16.6			12.7			10.8		
18.0	24.3			21.4			16.6			12.7			10.4		
20.0	23.0	16.2		21.4			16.3			12.7			10.0		
22.0	21.7	15.5		21.1	15.5		15.2	11.5		12.7			9.6		
24.0	19.9	14.8		19.4	14.8		14.3	10.9		12.6	9.9		9.2		
26.0	17.4	14.1	11.3	17.0	14.3		13.5	10.4		11.8	9.4		8.8	9.1	
28.0	15.3	13.6	11.0	14.9	13.7	11.0	12.7	10.0		11.1	9.0		8.3	8.7	
30.0	13.4	13.1	10.7	13.1	13.2	10.7	12.1	9.6	8.2	10.5	8.6	7.5	7.9	8.2	
32.0	11.8	12.6	10.4	11.5	12.8	10.5	11.4	9.2	7.9	10.0	8.2	7.2	7.4	7.7	6.5
34.0	10.3	12.1	10.2	10.1	12.3	10.2	10.1	8.8	7.6	9.5	7.9	6.9	7.0	7.3	6.2
36.0	8.9	10.9	9.9	8.8	10.9	10.0	8.8	8.5	7.4	8.8	7.6	6.7	6.6	6.8	5.9
38.0	7.6	9.5	9.7	7.6	9.6	9.8	7.7	8.2	7.2	7.7	7.3	6.5	6.1	6.5	5.7
40.0	6.5	8.2	9.5	6.5	8.3	9.6	6.7	7.9	7.0	6.8	7.0	6.3	5.8	6.1	5.4
42.0	5.6	7.1	8.3	5.6	7.2	8.5	5.8	7.4	6.8	5.9	6.7	6.1	5.4	5.8	5.1
44.0	4.7	6.1	7.2	4.7	6.2	7.3	4.9	6.4	6.6	5.0	6.5	5.9	4.7	5.5	4.9
46.0	3.9	5.2	6.1	3.9	5.2	6.3	4.1	5.5	6.5	4.2	5.7	5.7	4.0	5.1	4.7
48.0	3.1	4.3	5.1	3.1	4.4	5.4	3.3	4.6	5.7	3.5	4.8	5.5	3.3	4.7	4.5
50.0	2.5	3.5	4.2	2.5	3.6	4.5	2.7	3.9	4.8	2.8	4.1	5.0	2.6	4.0	4.3
54.0		2.1	2.6		2.3	2.9		2.5	3.3		2.7	3.5		2.6	3.5
58.0						1.5			1.9			2.2			



	40.4 m + 2.0 m + 29.5 m			45.4 m + 2.0 m + 29.5 m			50.5 m + 2.0 m + 29.5 m			55.6 m + 2.0 m + 29.5 m			60.0 m + 2.0 m + 29.5 m		
	0°	20°	40°	0°	20°	40°	0°	20°	40°	0°	20°	40°	0°	20°	40°
12.0	18.6														
14.0	18.6			16.1											
16.0	18.6			16.1			12.4			8.6					
18.0	18.6			16.1			12.4			8.6			7.0		
20.0	18.6			16.1			12.4			8.6			6.7		
22.0	17.8			16.1			12.4			8.6			6.3		
24.0	16.7	11.5		16.1	11.5		12.4			8.6			6.0		
26.0	15.7	11.0		15.7	11.0		11.9	9.0		8.6			5.6		
28.0	14.8	10.5		14.8	10.6		11.2	8.6		8.4	8.1		5.3		
30.0	13.4	10.1		13.0	10.2		10.6	8.2		8.3	7.7		4.9	6.7	
32.0	11.8	9.7	7.8	11.4	9.8	7.8	10.1	7.9		8.1	7.3		4.6	6.3	
34.0	10.4	9.3	7.6	10.1	9.4	7.6	9.6	7.5	6.4	7.9	7.0		4.2	5.9	
36.0	9.2	9.0	7.4	8.8	9.1	7.4	8.8	7.2	6.2	7.7	6.7	5.8	3.9	5.5	
38.0	8.0	8.7	7.2	7.7	8.8	7.2	7.7	7.0	6.0	7.5	6.4	5.6	3.5	5.2	4.4
40.0	6.9	8.4	7.0	6.7	8.5	7.1	6.7	6.7	5.8	6.8	6.2	5.4	3.2	4.9	4.2
42.0	5.9	7.8	6.9	5.8	7.8	6.9	5.8	6.5	5.6	5.9	5.9	5.2	2.9	4.6	4.0
44.0	5.0	6.8	6.7	4.9	6.8	6.8	5.0	6.2	5.4	5.1	5.7	5.0	2.6	4.3	3.8
46.0	4.2	5.8	6.6	4.1	5.8	6.6	4.2	6.0	5.3	4.3	5.5	4.8	2.3	4.1	3.6
48.0	3.4	5.0	6.3	3.4	5.0	6.3	3.5	5.1	5.1	3.6	5.2	4.6	2.1	3.9	3.4
50.0	2.8	4.2	5.3	2.7	4.2	5.4	2.8	4.4	5.0	3.0	4.6	4.4	1.8	3.6	3.3
54.0	1.6	2.8	3.7		2.8	3.8		3.0	4.1		3.3	4.0		3.0	3.0
58.0		1.6	2.2			2.4			2.7			3.1			2.7

	40.4 m + 2.0 m + 35.5 m			45.4 m + 2.0 m + 35.5 m			50.5 m + 2.0 m + 35.5 m			55.6 m + 2.0 m + 35.5 m			60.0 m + 2.0 m + 35.5 m		
	0°	20°	40°	0°	20°	40°	0°	20°	40°	0°	20°	40°	0°	20°	40°
14.0	14.1														
16.0	14.1			12.2											
18.0	14.1			12.2			8.8			6.1					
20.0	14.1			12.2			8.8			6.1			4.4		
22.0	14.1			12.2			8.8			6.1			4.2		
24.0	13.9			12.2			8.8			6.1			3.8		
26.0	13.0	9.0		12.2			8.8			6.0			3.5		
28.0	12.2	8.6		12.2	8.6		8.8			5.8			3.2		
30.0	11.6	8.2		11.8	8.2		8.8	7.5		5.7			2.9		
32.0	10.9	7.8		11.2	7.9		8.8	7.1		5.5	6.5		2.6	5.4	
34.0	10.3	7.5		10.2	7.6		8.8	6.8		5.3	6.2		2.2	5.0	
36.0	9.3	7.2	5.8	9.0	7.3		8.4	6.5		5.2	5.9		1.9	4.7	
38.0	8.2	6.9	5.6	7.9	7.0	5.6	7.9	6.3		5.0	5.7		1.6	4.4	
40.0	7.2	6.7	5.5	6.9	6.8	5.5	6.9	6.0	5.1	4.8	5.4			4.1	
42.0	6.2	6.4	5.3	6.0	6.5	5.3	6.0	5.8	4.9	4.6	5.1	4.4		3.9	3.3
44.0	5.3	6.2	5.2	5.2	6.3	5.2	5.2	5.6	4.7	4.3	4.9	4.2		3.6	3.1
46.0	4.5	6.0	5.0	4.4	6.1	5.1	4.5	5.4	4.6	4.1	4.6	4.0		3.4	2.9
48.0	3.8	5.7	4.9	3.7	5.6	4.9	3.8	5.2	4.4	3.7	4.3	3.8		3.2	2.7
50.0	3.1	4.9	4.8	3.0	4.8	4.8	3.2	5.0	4.2	3.1	4.1	3.6		3.0	2.6
54.0	2.0	3.5	4.6		3.4	4.6		3.7	3.9		3.7	3.2		2.6	2.3
58.0		2.2	3.3		2.2	3.4		2.5	3.6		2.5	2.9			2.0
62.0			2.0			2.1			2.5			2.6			

	40.4 m + 2.0 m + 41.5 m			45.4 m + 2.0 m + 41.5 m			50.5 m + 2.0 m + 41.5 m			55.6 m + 2.0 m + 41.5 m			60.0 m + 2.0 m + 41.5 m		
	0°	20°	40°	0°	20°	40°	0°	20°	40°	0°	20°	40°	0°	20°	40°
16.0	10.1			8.6											
18.0	10.1			8.6			6.0								
20.0	10.1			8.6			6.0			3.5					
22.0	10.1			8.6			6.0			3.5			1.9		
24.0	10.1			8.6			6.0			3.5			1.6		
26.0	10.1			8.6			6.0			3.4					
28.0	10.1			8.6			6.0			3.2					
30.0	9.5	6.5		8.6			6.0			3.1					
32.0	9.0	6.2		8.6	6.2		6.0			2.9					
34.0	8.4	5.9		8.6	5.9		6.0	5.9		2.8					
36.0	8.0	5.7		8.2	5.7		6.0	5.6		2.6	4.8			3.1	
38.0	7.6	5.4		7.7	5.5		6.0	5.3		2.4	4.6			3.1	
40.0	7.1	5.2		6.7	5.2		6.0	5.0		2.2	4.3			3.1	
42.0	6.2	5.0	3.9	5.8	5.0		5.7	4.7		2.0	4.0			2.9	
44.0	5.4	4.8	3.7	5.0	4.8	3.7	4.9	4.4		1.8	3.7			2.7	
46.0	4.6	4.6	3.6	4.3	4.6	3.6	4.2	4.2	3.3	1.6	3.5			2.5	
48.0	3.9	4.4	3.5	3.6	4.5	3.5	3.5	4.0	3.2		3.2	2.7		2.3	1.9
50.0	3.3	4.2	3.3	3.0	4.3	3.4	2.9	3.7	3.0		3.0	2.5		2.1	1.7
54.0	2.1	3.9	3.1		3.8	3.2		3.3	2.7		2.6	2.2		1.7	
58.0		2.7	2.9		2.6	3.0			2.4			1.9			
62.0			2.7			2.8			2.2						

MB
+ FJ + PS

Hubhöhen
Lifting heights
Hauteurs de levage
Alturas de elevación

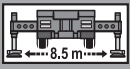
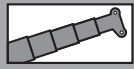

138t

DIN/ISO/EN

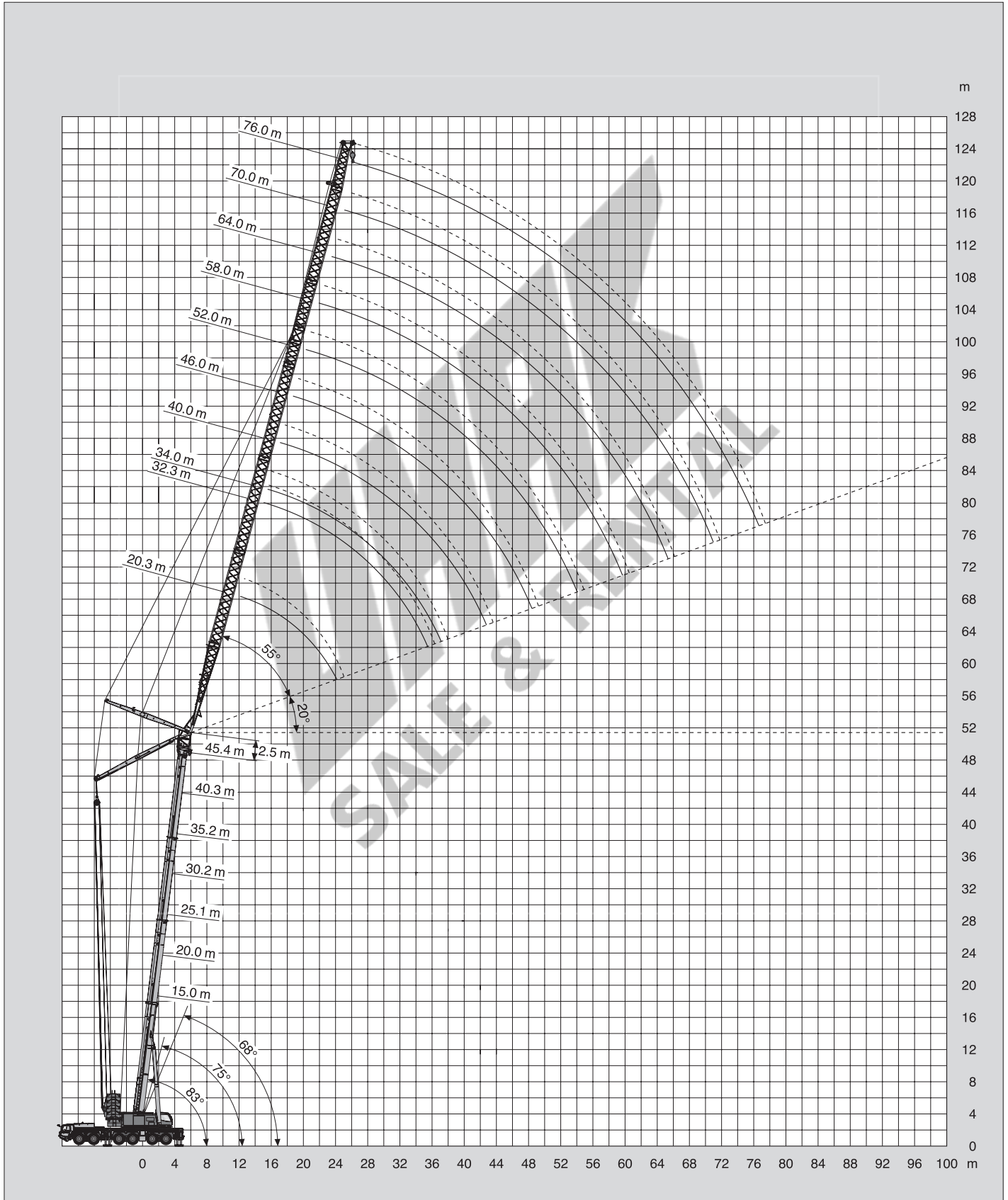

Tragfähigkeiten
Lifting capacities
Capacités de levage
Capacidades de elevación

				138 t	DIN/ISO/EN
--	---	---	---	--------------	-------------------

	15.0 m + 2.5 m + 20.3 m			20.1 m + 2.5 m + 20.3 m			25.1 m + 2.5 m + 20.3 m			30.2 m + 2.5 m + 20.3 m			35.3 m + 2.5 m + 20.3 m		
	83°	75°	68°	83°	75°	68°	83°	75°	68°	83°	75°	68°	83°	75°	68°
14.0							65.6								
16.0		67.4					59.2			55.8					
18.0		61.0			57.3		54.0			51.0			45.7		
20.0		55.8	56.5		52.4		47.1	47.6		46.4			41.6		
22.0		51.3	52.0		47.6		38.1	43.5		43.2	38.6		38.4		
24.0			48.1		44.8	41.8		40.3			35.5			31.9	
26.0						39.0		38.2	35.3		33.1			29.4	
28.0									32.9			28.4		27.4	
30.0												23.8			21.4
32.0															19.6

				138 t	DIN/ISO/EN
--	---	---	---	--------------	-------------------

	40.4 m + 2.5 m + 20.3 m			45.4 m + 2.5 m + 20.3 m									
	83°	75°	68°	83°	75°	68°							
14.0													
16.0													
18.0	39.0												
20.0	36.6			30.7									
22.0	33.6			28.1									
24.0	31.3			24.1									
26.0		25.8											
28.0		22.1											
30.0		20.3			17.7								
32.0													
34.0			16.3										
36.0						13.8							

MB+LJ

Tragfähigkeiten
Lifting capacities
Capacités de levage
Capacidades de elevación





 m	15.0 m + 2.5 m + 32.3 m			20.1 m + 2.5 m + 32.3 m			25.1 m + 2.5 m + 32.3 m			30.2 m + 2.5 m + 32.3 m			35.3 m + 2.5 m + 32.3 m		
	83°	75°	68°	83°	75°	68°	83°	75°	68°	83°	75°	68°	83°	75°	68°
12.0	61.2														
14.0	59.6			49.5			43.5								
16.0	57.2			47.9			42.6			38.1					
18.0	52.2			46.8			41.8			37.5			32.4		
20.0	48.0	48.8		45.1	45.2		41.1			36.8			31.9		
22.0	44.4	45.1		41.8	41.8		39.5	38.8		36.3			31.5		
24.0	41.3	41.9	42.3	39.0	38.9		36.9	36.1		35.0	33.6		31.0		
26.0	38.6	39.2	39.4	36.5	36.4	36.0	34.6	33.8		32.8	31.5		30.4		
28.0	34.4	36.8	37.0	34.3	34.2	33.8	32.6	31.8		30.9	29.2		28.7	26.1	
30.0	28.6	34.6	34.8	32.4	32.2	31.8	30.8	29.9	29.1	29.2	27.3		27.1	22.4	
32.0	20.4	32.7	32.9	24.9	30.5	30.1	29.2	28.3	27.5	27.7	23.4	21.6	22.7	20.3	
34.0		24.9	31.1		28.9	28.5	21.9	26.9	23.8	25.7	21.3	20.0	21.2	19.0	17.8
36.0			29.4		27.3	26.0		23.0	21.7		20.0	18.7		17.7	16.5
38.0					23.0			22.2	20.4		19.0	17.5		16.7	15.4
40.0									19.3			16.4		15.8	14.4
42.0												15.5			13.5
44.0															12.7

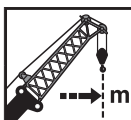

 m	40.4 m + 2.5 m + 32.3 m			45.4 m + 2.5 m + 32.3 m			50.5 m + 2.5 m + 32.3 m								
	83°	75°	68°	83°	75°	68°	83°	75°	68°						
20.0	22.5														
22.0	22.1			17.8			13.7								
24.0	21.7			17.7			13.7								
26.0	21.3			17.4			13.7								
28.0	21.0			17.1			13.5								
30.0	20.7	19.6		16.9			13.3								
32.0	19.6	18.1		16.1	15.3		13.2								
34.0	18.5	16.9		15.1	14.2		12.9	11.7							
36.0	17.6	15.7		14.2	13.2		11.8	10.9							
38.0		14.7	13.5		12.3			10.1							
40.0		13.8	12.6		11.5	11.0		9.4							
42.0		13.0	11.8		10.8	10.3		8.8							
44.0			11.0			9.6		8.2	7.6						
46.0			10.4			9.0			7.1						
48.0						8.4			6.6						
50.0									6.2						

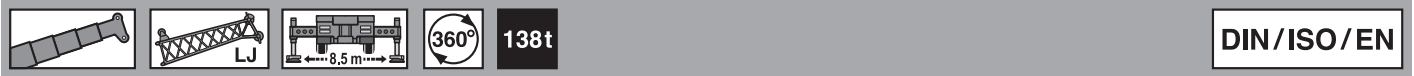
Tragfähigkeiten
Lifting capacities
Capacités de levage
Capacidades de elevación



 m	15.0 m + 2.5 m + 34.0 m			20.1 m + 2.5 m + 34.0 m			25.1 m + 2.5 m + 34.0 m			30.2 m + 2.5 m + 34.0 m			35.3 m + 2.5 m + 34.0 m		
	83°	75°	68°	83°	75°	68°	83°	75°	68°	83°	75°	68°	83°	75°	68°
14.0	53.2			46.1											
16.0	48.3			45.0			40.1			35.7					
18.0	44.1			43.6			39.4			35.1			29.5		
20.0	40.6	44.5		40.7			38.6			34.6			29.1		
22.0	37.6	41.1		37.9	40.8		37.9			34.0			28.7		
24.0	35.0	38.0		35.4	38.0		35.6	35.1		33.5			28.4		
26.0	32.7	35.4	37.9	33.1	35.6		33.5	32.9		31.9	29.7		27.7		
28.0	30.7	33.0	35.3	31.1	33.4	33.0	31.6	30.9		30.1	27.6		25.3	22.1	
30.0	29.0	31.0	33.0	29.4	31.5	31.1	29.8	29.1	28.0	28.4	24.9		21.6	20.4	
32.0	24.2	29.2	31.0	27.8	29.8	29.1	28.2	27.5	25.4	27.0	21.5	19.8	20.4	19.0	
34.0		27.6	29.2	21.2	28.3	26.1	22.5	23.3	21.9	23.1	20.1	18.4	19.4	17.7	
36.0		21.2	27.5		25.3	22.9		22.0	20.5	20.6	18.9	17.1	18.7	16.5	15.7
38.0			22.9		21.4	21.7		20.9	19.2		17.9	16.0		15.5	14.6
40.0						20.8		20.1	18.1		17.0	15.0		14.6	13.6
42.0									17.3			14.2		13.9	12.7
44.0												13.4			11.9
46.0															11.2

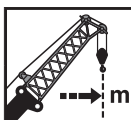

 m	40.4 m + 2.5 m + 34.0 m			45.4 m + 2.5 m + 34.0 m			50.5 m + 2.5 m + 34.0 m			55.6 m + 2.5 m + 34.0 m					
	83°	75°	68°	83°	75°	68°	83°	75°	68°	83°	75°	68°			
20.0	21.3														
22.0	20.9			17.0											
24.0	20.5			16.5			13.0			9.2					
26.0	20.2			16.2			12.8			9.0					
28.0	19.9			16.1			12.7			8.7					
30.0	19.6	19.5		15.9			12.6			8.6					
32.0	19.2	18.0		15.8	15.1		12.6			8.5					
34.0	18.4	16.8		15.2	14.0		12.5	11.6		8.5					
36.0	17.4	15.7		14.1	13.1		11.9	10.7		8.5					
38.0	16.6	14.7	13.4	13.3	12.2		11.0	10.0		8.5	8.0				
40.0		13.8	12.5		11.4			9.3		8.1	7.4				
42.0		13.0	11.7		10.7	10.1		8.7			6.9				
44.0		12.3	11.0		10.1	9.5		8.1	7.5		6.4				
46.0			10.3			8.9		7.6	7.0		6.0				
48.0			9.7			8.3			6.5		5.6	5.0			
50.0						7.8			6.1			4.7			
54.0												4.0			

Tragfähigkeiten
Lifting capacities
Capacités de levage
Capacidades de elevación



	15.0 m + 2.5 m + 40.0 m			20.1 m + 2.5 m + 40.0 m			25.1 m + 2.5 m + 40.0 m			30.2 m + 2.5 m + 40.0 m			35.3 m + 2.5 m + 40.0 m			
	83°	75°	68°	83°	75°	68°	83°	75°	68°	83°	75°	68°	83°	75°	68°	
14.0	36.7															
16.0	33.2			33.2												
18.0	30.3			30.4			30.3									
20.0	27.5			28.0			28.2				20.6			21.8		
22.0	24.4	27.5		25.1			26.0				20.3			21.4		
24.0	22.1	24.3		22.3	26.0		23.1				19.8			21.0		
26.0	20.3	22.3		20.7	23.2		21.0	24.9			19.0			20.4		
28.0	18.8	20.6	22.2	19.2	21.4		19.5	22.2			18.0	19.7		19.6		
30.0	17.5	19.0	20.5	17.8	19.9		18.1	20.7			17.0	19.2		18.5	20.4	
32.0	16.3	17.7	19.0	16.6	18.4	20.2	16.9	19.2			16.0	18.2		17.4	19.9	
34.0	15.2	16.5	17.6	15.5	17.2	18.8	15.8	17.9	19.9		15.1	17.2		16.4	19.0	
36.0	14.3	15.4	16.4	14.5	16.0	17.5	14.8	16.7	18.6		14.2	16.2	17.9	15.4	17.9	
38.0	13.4	14.4	15.4	13.6	15.0	16.3	13.9	15.7	17.3		13.5	15.3	16.9	14.5	16.8	
40.0		13.5	14.4	12.8	14.1	15.3	13.1	14.7	16.2		12.7	14.4	16.0	13.7	15.8	14.5
42.0		12.8	13.5		13.2	14.3		13.8	15.2		12.1	13.7	15.1	12.9	14.9	13.6
44.0					12.5	13.5		13.0	14.3			12.9	14.3		14.1	12.8
46.0						12.7			13.4			12.3	13.6		13.4	12.1
48.0									12.7				12.9		12.7	11.4
50.0												12.2				10.8

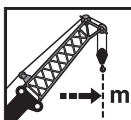

	40.4 m + 2.5 m + 40.0 m			45.4 m + 2.5 m + 40.0 m			50.5 m + 2.5 m + 40.0 m			55.6 m + 2.5 m + 40.0 m					
	83°	75°	68°	83°	75°	68°	83°	75°	68°	83°	75°	68°			
24.0	17.5			14.5											
26.0	17.0			14.3			11.7			9.4					
28.0	16.7			14.1			11.2			9.3					
30.0	16.4			14.1			10.9			9.2					
32.0	16.2			14.0			10.9			9.1					
34.0	15.8	16.4		13.9			10.9			8.9					
36.0	15.2	15.8		13.8	13.2		10.9			8.7					
38.0	14.5	14.8		13.5	12.3		10.7	9.9		8.4					
40.0	13.7	13.9		12.6	11.5		10.3	9.2		7.9	7.2				
42.0	13.0	13.1	11.8	11.9	10.8		9.7	8.6		7.4	6.7				
44.0	12.4	12.4	11.1	11.4	10.2		9.2	8.1		7.0	6.2				
46.0		11.7	10.4		9.6	8.9		7.6			5.8				
48.0		11.1	9.8		9.1	8.4		7.1	6.4		5.5				
50.0		10.6	9.2		8.6	7.9		6.7	6.0		5.1	4.5			
54.0			8.3			7.0			5.3		4.5	3.9			
58.0									4.6			3.4			

138t Light

DIN/ISO/EN

m	15.0 m + 2.5 m + 46.0 m			20.1 m + 2.5 m + 46.0 m			25.1 m + 2.5 m + 46.0 m			30.2 m + 2.5 m + 46.0 m			35.3 m + 2.5 m + 46.0 m		
	83°	75°	68°	83°	75°	68°	83°	75°	68°	83°	75°	68°	83°	75°	68°
16.0	25.8														
18.0	22.8			23.1											
20.0	20.6			20.6			20.5								
22.0	18.9			19.0			19.1				18.9			18.2	
24.0	17.4	19.1		17.5			17.7				17.7			17.8	
26.0	16.0	17.6		16.2	18.1		16.4				16.5			16.9	
28.0	14.8	16.2		15.0	16.8		15.2				15.4			15.9	
30.0	13.8	15.0		13.9	15.6		14.2	16.1			14.4			15.0	
32.0	12.8	13.9	14.9	13.0	14.4		13.2	15.0			13.5	15.5		14.0	
34.0	12.0	12.9	13.8	12.1	13.5	14.7	12.4	14.0			12.6	14.5		13.2	15.4
36.0	11.2	12.1	12.9	11.4	12.5	13.6	11.6	13.1			11.8	13.6		12.4	14.5
38.0	10.5	11.3	12.0	10.7	11.7	12.8	10.9	12.2	13.5		11.1	12.7		11.6	13.7
40.0	9.8	10.6	11.3	10.0	11.0	11.9	10.2	11.4	12.7	13.5	10.4	11.9	13.4	10.9	12.8
42.0	9.3	9.9	10.6	9.4	10.3	11.2	9.6	10.8	11.8		9.8	11.2	12.6	10.3	12.1
44.0	8.7	9.4	9.9	8.9	9.7	10.5	9.1	10.1	11.1		9.2	10.5	11.8	9.7	11.4
46.0		8.8	9.3	8.4	9.2	9.9	8.6	9.5	10.5		8.7	9.9	11.1	9.1	10.7
48.0		8.3	8.8		8.6	9.3		9.0	9.8			9.4	10.4	8.6	10.1
50.0						8.8		8.5	9.3			8.8	9.8		9.5
54.0									8.3				8.8		8.5
58.0															8.6

138t Light

DIN/ISO/EN

m	40.4 m + 2.5 m + 46.0 m			45.4 m + 2.5 m + 46.0 m			50.5 m + 2.5 m + 46.0 m			55.6 m + 2.5 m + 46.0 m					
	83°	75°	68°	83°	75°	68°	83°	75°	68°	83°	75°	68°			
26.0	15.1			12.7			10.2								
28.0	14.8			12.6			10.1			7.8					
30.0	14.4			12.5			10.0			7.7					
32.0	13.8			12.4			9.8			7.6					
34.0	13.2			12.2			9.8			7.5					
36.0	12.6	14.4		11.9			9.7			7.4					
38.0	11.9	13.9		11.5	12.2		9.6			7.4					
40.0	11.3	13.2		11.1	11.4		9.5	9.0		7.3					
42.0	10.6	12.6		10.6	10.7		9.3	8.4		7.2					
44.0	10.1	12.0		10.1	10.1		9.0	7.9		6.8	6.0				
46.0	9.5	11.3	10.5	9.6	9.5		8.5	7.4		6.4	5.6				
48.0	9.0	10.7	9.9	9.2	9.0	8.2	8.1	7.0		6.1	5.2				
50.0		10.1	9.3	8.7	8.5	7.7	7.7	6.6		5.7	4.9				
54.0		9.1	8.3		7.6	6.9		5.9	5.1		4.3	3.7			
58.0			7.5			6.1		5.3	4.5		3.8	3.2			
62.0						5.5			3.9			2.7			
66.0												2.3			

MB+LJ

Tragfähigkeiten
Lifting capacities
Capacités de levage
Capacidades de elevación



 ---> m	15.0 m + 2.5 m + 46.0 m			20.1 m + 2.5 m + 46.0 m			25.1 m + 2.5 m + 40.0 m			30.2 m + 2.5 m + 46.0 m			35.3 m + 2.5 m + 46.0 m		
	83°	75°	68°	83°	75°	68°	83°	75°	68°	83°	75°	68°	83°	75°	68°
16.0	36.7														
18.0	35.8			30.8											
20.0	35.1			30.2			23.7								
22.0	34.3			29.7			23.2			18.5			17.9		
24.0	33.6			29.2			22.8			18.2			17.6		
26.0	32.5	32.7		28.7			22.4			17.9			17.4		
28.0	30.6	30.8		28.3	28.2		22.0			17.7			17.1		
30.0	29.0	29.2		27.1	26.5		21.7	21.8		17.4			16.9		
32.0	27.5	27.6	27.5	25.6	24.0		21.4	21.5		17.2	17.3		16.6		
34.0	26.2	26.3	26.1	23.4	23.5	23.5	21.1	21.1		17.0	17.1		16.4	16.6	
36.0	25.0	25.0	24.9	23.1	22.9	22.4	20.8	20.8		16.8	16.9		16.2	16.2	
38.0	22.1	23.9	23.7	22.4	21.9	21.4	20.5	20.1	19.3	16.6	16.6		16.1	15.2	
40.0	19.7	22.5	22.7	21.2	20.9	20.4	20.2	19.2	18.3	16.4	16.2	14.8	15.9	14.3	
42.0	17.0	20.8	21.7	19.3	20.0	19.5	19.4	18.3	17.2	16.3	15.3	13.8	15.5	13.5	11.8
44.0	14.4	19.1	20.8	16.7	19.3	18.4	18.3	17.3	16.2	16.2	14.4	13.0	15.0	12.7	11.1
46.0		16.8	19.2	13.7	18.5	17.5	16.0	16.5	15.3	16.0	13.7	12.2	14.3	12.0	10.4
48.0		13.9	17.8		17.2	16.6		15.8	14.5	15.3	13.0	11.5	13.8	11.3	9.8
50.0						16.0		15.2	13.7		12.4	10.9	10.8	9.2	
54.0									12.6			9.8		9.8	8.2
58.0														9.8	7.4

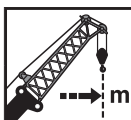

 ---> m	40.4 m + 2.5 m + 46.0 m			45.4 m + 2.5 m + 46.0 m			50.5 m + 2.5 m + 46.0 m			55.6 m + 2.5 m + 46.0 m					
	83°	75°	68°	83°	75°	68°	83°	75°	68°	83°	75°	68°			
26.0	14.9			12.9			10.1								
28.0	14.8			12.8			10.0			7.7					
30.0	14.6			12.7			9.9			7.5					
32.0	14.4			12.5			9.8			7.5					
34.0	14.3			12.3			9.7			7.4					
36.0	14.2	14.5		12.2			9.6			7.3					
38.0	14.1	14.4		12.2	11.8		9.6			7.2					
40.0	14.0	13.6		11.9	11.1		9.5	8.7		7.1					
42.0	13.9	12.9		11.4	10.4		9.1	8.1		6.9	6.1				
44.0	13.5	12.1		10.8	9.7		8.7	7.6		6.5	5.6				
46.0	12.9	11.4	10.2	10.3	9.2		8.2	7.1		6.1	5.3				
48.0	12.4	10.8	9.5	9.8	8.6	7.9	7.7	6.7		5.7	4.9				
50.0		10.2	9.0	9.3	8.1	7.4	7.3	6.3	5.4	5.4	4.6				
54.0		9.2	7.9		7.3	6.5		5.5	4.7		4.0	3.3			
58.0			7.1			5.8		4.9	4.1		3.5	2.8			
62.0						5.2			3.6			2.4			
66.0												2.0			

Tragfähigkeiten
Lifting capacities
Capacités de levage
Capacidades de elevación

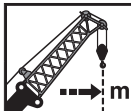

 ---> m	15.0 m + 2.5 m + 52.0 m			20.1 m + 2.5 m + 52.0 m			25.1 m + 2.5 m + 52.0 m			30.2 m + 2.5 m + 52.0 m			35.3 m + 2.5 m + 52.0 m		
	83°	75°	68°	83°	75°	68°	83°	75°	68°	83°	75°	68°	83°	75°	68°
18.0	18.8														
20.0	17.2			17.1											
22.0	15.8			15.8			15.8								
24.0	14.6			14.6			14.7				14.6				
26.0	13.5			13.5			13.7				13.7			13.9	
28.0	12.5	13.6		12.6			12.7				12.8			13.2	
30.0	11.6	12.6		11.7	13.0		11.9				12.0			12.5	
32.0	10.8	11.7		10.9	12.1		11.1	12.5			11.2			11.9	
34.0	10.1	10.8		10.2	11.3		10.3	11.6			10.5	12.0		11.2	
36.0	9.4	10.2	10.8	9.5	10.5		9.7	10.9			9.8	11.3		10.5	
38.0	8.8	9.5	10.1	8.9	9.8	10.7	9.1	10.2			9.2	10.6		9.9	11.6
40.0	8.3	8.9	9.5	8.4	9.2	10.0	8.5	9.6	10.5		8.7	9.9		9.3	11.0
42.0	7.8	8.3	8.9	7.9	8.6	9.3	8.0	9.0	9.9		8.2	9.3		8.7	10.3
44.0	7.3	7.8	8.3	7.4	8.1	8.8	7.6	8.4	9.3		7.7	8.8	9.8	8.2	9.7
46.0	6.9	7.4	7.8	7.0	7.6	8.2	7.1	7.9	8.7		7.3	8.2	9.2	7.8	9.1
48.0	6.5	7.0	7.4	6.6	7.2	7.8	6.7	7.5	8.2		6.9	7.8	8.7	7.3	8.6
50.0	6.2	6.6	6.9	6.3	6.8	7.3	6.4	7.1	7.7		6.5	7.3	8.2	6.9	8.1
54.0		5.9	6.2		6.1	6.5		6.3	6.9			6.6	7.3	6.2	7.2
58.0									6.2			5.9	6.5	6.4	7.3
62.0												5.9			6.5



 ---> m	40.4 m + 2.5 m + 52.0 m			45.4 m + 2.5 m + 52.0 m			50.5 m + 2.5 m + 52.0 m			55.6 m + 2.5 m + 52.0 m					
	83°	75°	68°	83°	75°	68°	83°	75°	68°	83°	75°	68°			
26.0	12.8														
28.0	12.5			10.8			8.5								
30.0	12.0			10.7			8.4				6.2				
32.0	11.5			10.4			8.3				6.1				
34.0	11.0			10.2			8.2				6.1				
36.0	10.4			9.8			8.1				6.0				
38.0	9.9			9.5			8.1				6.0				
40.0	9.4	10.9		9.1	10.2		8.0				5.9				
42.0	8.8	10.4		8.7	9.9		7.9				5.9				
44.0	8.4	9.9		8.3	9.6		7.7	7.8			5.9				
46.0	7.9	9.4		7.9	9.2		7.5	7.3			5.9	5.4			
48.0	7.5	8.9		7.6	8.9		7.2	6.9			5.8	5.1			
50.0	7.1	8.4	9.4	7.2	8.4		7.0	6.5			5.6	4.7			
54.0	6.3	7.5	8.4	6.5	7.6	6.8	6.5	5.8	4.9		5.0	4.2			
58.0		6.7	7.5		6.8	6.1		5.2	4.3			3.6	3.0		
62.0		6.1	6.7		6.2	5.4		4.6	3.8			3.2	2.5		
66.0			6.1			4.9			3.4			2.8	2.2		
70.0									3.0				1.8		

Tragfähigkeiten
Lifting capacities
Capacités de levage
Capacidades de elevación



 m	15.0 m + 2.5 m + 52.0 m			20.1 m + 2.5 m + 52.0 m			25.1 m + 2.5 m + 52.0 m			30.2 m + 2.5 m + 52.0 m			35.3 m + 2.5 m + 52.0 m		
	83°	75°	68°	83°	75°	68°	83°	75°	68°	83°	75°	68°	83°	75°	68°
18.0	29.8														
20.0	29.2			22.3											
22.0	27.8			21.9			19.6								
24.0	25.4			21.5			19.3			14.8			16.0		
26.0	23.5			21.1			18.9			14.7			15.9		
28.0	22.2	24.5		20.7			18.6			14.6			15.7		
30.0	21.0	22.3		20.4	20.4		18.4			14.5			15.6		
32.0	19.8	21.1		19.5	20.1		18.1	18.1		14.5			15.5		
34.0	18.8	19.9		18.6	19.5		17.9	17.9		14.4	14.4		15.3		
36.0	17.8	18.9	19.8	17.7	19.0		17.5	17.6		14.3	14.3		15.2	15.4	
38.0	16.9	17.9	18.8	16.9	18.1	18.8	16.8	17.4		14.3	14.2		15.1	15.1	
40.0	16.1	17.0	17.9	16.1	17.2	18.2	16.1	17.0	16.8	14.2	14.2		15.0	14.4	
42.0	15.3	16.2	17.0	15.3	16.4	17.4	15.3	16.6	16.0	14.2	14.1		14.9	13.8	
44.0	14.6	15.4	16.1	14.6	15.7	16.6	14.7	15.9	15.4	14.1	14.1	13.6	14.8	13.2	
46.0	13.9	14.7	15.4	14.0	15.0	15.8	14.1	15.2	14.8	13.6	14.0	13.1	14.2	12.7	11.5
48.0	13.2	14.0	14.7	13.4	14.3	15.1	13.5	14.6	14.2	13.2	13.6	12.6	13.8	12.2	11.0
50.0	11.8	13.4	14.0	12.8	13.7	14.5	12.9	14.0	13.7	12.7	13.1	12.1	13.3	11.8	10.6
54.0		11.6	12.8		12.6	13.3		12.9	12.7	11.9	12.2	11.2	12.5	10.8	9.6
58.0									11.7		11.5	10.1		9.8	8.6
62.0											9.3				7.8

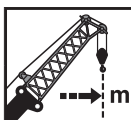

 m	40.4 m + 2.5 m + 52.0 m			45.4 m + 2.5 m + 52.0 m			50.5 m + 2.5 m + 52.0 m			55.6 m + 2.5 m + 52.0 m					
	83°	75°	68°	83°	75°	68°	83°	75°	68°	83°	75°	68°			
26.0	13.8														
28.0	13.7			11.2			8.6								
30.0	13.6			11.1			8.5			6.1					
32.0	13.5			11.0			8.4			6.0					
34.0	13.4			10.9			8.3			6.0					
36.0	13.3			10.8			8.2			6.0					
38.0	13.2			10.8			8.2			6.0					
40.0	13.0	12.6		10.7	10.8		8.1			5.9					
42.0	12.9	12.1		10.6	10.2		8.0			5.8					
44.0	12.8	11.6		10.4	9.7		8.0	7.5		5.8					
46.0	12.6	11.1		10.2	9.1		7.9	7.0		5.8	5.1				
48.0	12.3	10.7		9.7	8.6		7.7	6.6		5.6	4.7				
50.0	11.8	10.3	9.0	9.2	8.1		7.3	6.2		5.3	4.4				
54.0	10.9	9.3	8.0	8.4	7.3	6.5	6.6	5.5	4.6	4.7	3.8				
58.0		8.4	7.2		6.5	5.7		4.8	4.0		3.3	2.6			
62.0		7.7	6.4		5.9	5.1		4.3	3.5		2.9	2.2			
66.0			5.8			4.5			3.0		2.5	1.8			
70.0									2.6			1.5			

360° **138t** Light DIN/ISO/EN

	15.0 m + 2.5 m + 58.0 m			20.1 m + 2.5 m + 58.0 m			25.1 m + 2.5 m + 58.0 m			30.2 m + 2.5 m + 58.0 m			35.3 m + 2.5 m + 58.0 m		
	83°	75°	68°	83°	75°	68°	83°	75°	68°	83°	75°	68°	83°	75°	68°
22.0	20.9			19.1											
24.0	19.9			18.8			16.8								
26.0	18.8			18.1			16.6			16.4			14.5		
28.0	17.6			17.3			16.3			16.1			14.4		
30.0	16.7			16.4			16.1			15.7			14.2		
32.0	15.7	16.8		15.6			15.4			15.3			14.1		
34.0	14.8	15.8		14.8	16.0		14.7			14.7			13.8		
36.0	14.0	15.0		14.0	15.2		14.0	15.1		14.1			13.5		
38.0	13.3	14.1		13.3	14.4		13.3	14.5		13.5	14.8		13.1	13.9	
40.0	12.6	13.4	14.1	12.7	13.7		12.7	13.9		12.9	14.2		12.6	13.5	
42.0	12.0	12.7	13.4	12.0	13.0	13.8	12.1	13.2		12.4	13.6		12.2	13.2	
44.0	11.4	12.1	12.7	11.5	12.3	13.1	11.5	12.6	13.5	11.8	13.0		11.7	12.7	
46.0	10.8	11.5	12.0	10.9	11.7	12.5	11.0	12.0	12.9	11.3	12.5		11.3	12.2	
48.0	10.3	10.9	11.4	10.4	11.2	11.9	10.5	11.5	12.3	10.8	11.9	11.4	10.8	11.6	
50.0	9.8	10.4	10.9	9.9	10.7	11.3	10.0	10.9	11.7	10.3	11.4	11.0	10.4	10.9	9.4
54.0	9.0	9.5	9.9	9.1	9.7	10.3	9.2	10.0	10.7	9.4	10.4	10.2	9.6	9.8	8.3
58.0		8.7	9.1		8.9	9.4	8.4	9.1	9.8	8.7	9.6	9.2	8.8	8.9	7.4
62.0						8.6		8.4	9.0		8.8	8.3		8.1	6.6
66.0												7.6		7.5	6.0
70.0															5.4

360° **138t** Light DIN/ISO/EN

	40.4 m + 2.5 m + 58.0 m			45.4 m + 2.5 m + 58.0 m			50.5 m + 2.5 m + 58.0 m			55.6 m + 2.5 m + 58.0 m					
	83°	75°	68°	83°	75°	68°	83°	75°	68°	83°	75°	68°			
28.0	11.8														
30.0	11.7			9.4			7.0								
32.0	11.7			9.3			6.9			4.9					
34.0	11.6			9.3			6.9			4.9					
36.0	11.5			9.2			6.8			4.8					
38.0	11.4			9.1			6.7			4.8					
40.0	11.3	11.4		9.1			6.7			4.7					
42.0	11.1	11.4		9.0			6.7			4.6					
44.0	10.9	11.3		9.0	8.9		6.6			4.6					
46.0	10.6	11.1		8.9	8.8		6.6	6.7		4.6					
48.0	10.4	10.8		8.9	8.5		6.6	6.4		4.6	4.5				
50.0	10.1	10.3		8.9	8.0		6.6	6.0		4.6	4.2				
54.0	9.4	9.3	8.0	8.2	7.1		6.3	5.3		4.5	3.6				
58.0	8.8	8.3	7.1	7.5	6.4	5.6	5.8	4.7	3.8	4.0	3.1				
62.0		7.5	6.4		5.7	5.0	5.2	4.1	3.3	3.6	2.7	1.9			
66.0		6.9	5.7		5.2	4.4		3.7	2.8		2.3	1.6			
70.0			5.1			3.9		3.2	2.4		2.0				
74.0						3.5			2.1						

MB + LJ

Tragfähigkeiten
Lifting capacities
Capacités de levage
Capacidades de elevación

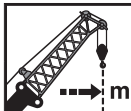

 m	15.0 m + 2.5 m + 58.0 m			20.1 m + 2.5 m + 58.0 m			25.1 m + 2.5 m + 58.0 m			30.2 m + 2.5 m + 58.0 m			35.3 m + 2.5 m + 58.0 m		
	83°	75°	68°	83°	75°	68°	83°	75°	68°	83°	75°	68°	83°	75°	68°
20.0	25.6														
22.0	23.9			19.9											
24.0	23.0			19.7			17.5								
26.0	22.6			19.4			17.3				16.7			14.6	
28.0	22.3			19.2			17.1				16.5			14.4	
30.0	22.0	22.1		19.0			16.9				16.3			14.3	
32.0	21.6	21.7		18.7	18.8		16.7				16.2			14.2	
34.0	21.3	21.5		18.5	18.6		16.6				16.0			14.0	
36.0	20.8	20.6		18.3	18.4		16.4	16.5			15.8			13.9	
38.0	19.9	19.7		18.1	18.0		16.2	16.4			15.7	15.1		13.8	13.9
40.0	19.1	18.9	18.6	17.9	17.3		16.1	15.7			15.6	14.4		13.7	13.7
42.0	18.4	18.1	17.8	17.2	16.6	16.0	16.0	15.0			15.1	13.8		13.6	13.1
44.0	17.7	17.4	17.1	16.6	15.9	15.3	15.5	14.4	13.5		14.6	13.2		13.5	12.6
46.0	17.1	16.8	16.5	16.0	15.3	14.7	14.9	13.8	13.0		14.0	12.7	11.6	13.4	11.9
48.0	16.0	16.2	15.9	15.4	14.7	14.2	14.4	13.3	12.4		13.5	12.2	11.1	13.0	11.2
50.0	14.7	15.7	15.3	14.9	14.2	13.6	13.9	12.8	12.0		13.0	11.7	10.7	12.6	10.6
54.0	11.3	14.3	14.4	13.0	13.3	12.7	13.0	11.9	11.1		12.2	10.9	9.8	11.5	9.5
58.0		11.5	13.4		12.5	11.9	10.9	11.2	10.3		11.5	10.2	9.1	10.6	8.5
62.0						10.8		10.5	9.4			9.5	8.3		7.7
66.0												7.4			7.1
70.0															5.1



 m	40.4 m + 2.5 m + 58.0 m			45.4 m + 2.5 m + 58.0 m			50.5 m + 2.5 m + 58.0 m			55.6 m + 2.5 m + 58.0 m					
	83°	75°	68°	83°	75°	68°	83°	75°	68°	83°	75°	68°			
28.0	11.8														
30.0	11.7			9.3			6.7								
32.0	11.6			9.2			6.7			4.7					
34.0	11.5			9.1			6.6			4.6					
36.0	11.4			9.0			6.6			4.6					
38.0	11.3			9.0			6.6			4.6					
40.0	11.2			8.9			6.5			4.5					
42.0	11.1	11.2		8.8			6.5			4.4					
44.0	11.0	11.2		8.8	8.7		6.4			4.3					
46.0	11.0	10.7		8.7	8.5		6.4	6.4		4.3					
48.0	10.9	10.3		8.7	8.1		6.4	6.0		4.3	4.1				
50.0	10.8	9.9		8.6	7.6		6.4	5.7		4.3	3.8				
54.0	10.2	8.9	7.7	7.9	6.8		6.0	4.9		4.2	3.2				
58.0	9.4	8.0	6.8	7.1	6.0	5.2	5.4	4.3	3.4	3.6	2.7				
62.0		7.2	6.0		5.4	4.6	4.9	3.8	2.9	3.2	2.3	1.6			
66.0		6.5	5.3		4.8	4.0		3.3	2.5		1.9				
70.0			4.8			3.6		2.9	2.1		1.6				
74.0						3.1			1.7						





138t Light

DIN/ISO/EN

 m	15.0 m + 2.5 m + 64.0 m			20.1 m + 2.5 m + 64.0 m			25.1 m + 2.5 m + 64.0 m			30.2 m + 2.5 m + 64.0 m			35.3 m + 2.5 m + 64.0 m		
	83°	75°	68°	83°	75°	68°	83°	75°	68°	83°	75°	68°	83°	75°	68°
24.0	16.5														
26.0	15.6			15.0			14.6								
28.0	14.8			14.4			14.1			13.4					
30.0	13.9			13.7			13.5			13.0			12.0		
32.0	13.1			13.0			12.9			12.5			11.7		
34.0	12.4	13.2		12.4			12.3			12.0			11.4		
36.0	11.7	12.5		11.7	12.7		11.7			11.6			11.0		
38.0	11.1	11.8		11.1	12.0		11.1	12.2		11.1			10.7		
40.0	10.5	11.2		10.5	11.4		10.6	11.6		10.6	11.6		10.3		
42.0	9.9	10.6	11.1	10.0	10.8		10.1	11.0		10.1	11.1		9.9	10.8	
44.0	9.4	10.0	10.5	9.5	10.3		9.6	10.5		9.6	10.7		9.5	10.5	
46.0	9.0	9.5	10.0	9.0	9.8	10.4	9.1	10.0		9.2	10.2		9.1	10.1	
48.0	8.5	9.0	9.5	8.6	9.3	9.9	8.7	9.5	10.3	8.8	9.7		8.8	9.7	
50.0	8.1	8.6	9.0	8.2	8.8	9.4	8.3	9.1	9.8	8.4	9.3	10.1	8.4	9.4	
54.0	7.4	7.8	8.2	7.5	8.0	8.5	7.6	8.3	8.9	7.7	8.5	9.2	7.7	8.6	7.8
58.0	6.7	7.1	7.4	6.8	7.3	7.8	6.9	7.5	8.1	7.0	7.8	8.4	7.1	7.9	7.2
62.0	6.2	6.5	6.8	6.3	6.7	7.1	6.4	6.9	7.4	6.4	7.1	7.7	6.5	7.3	6.6
66.0			6.2		6.1	6.5		6.3		6.8		7.1	6.5	6.7	5.9
70.0										6.2		6.0	6.5	6.2	5.3
74.0												6.0			4.8





138t Light

DIN/ISO/EN

 m	40.4 m + 2.5 m + 64.0 m			45.4 m + 2.5 m + 64.0 m			50.5 m + 2.5 m + 64.0 m			55.6 m + 2.5 m + 64.0 m					
	83°	75°	68°	83°	75°	68°	83°	75°	68°	83°	75°	68°			
30.0	9.9														
32.0	9.8			7.9			5.7								
34.0	9.8			7.8			5.7			4.0					
36.0	9.7			7.8			5.6			4.0					
38.0	9.6			7.7			5.5			3.9					
40.0	9.4			7.7			5.4			3.9					
42.0	9.2			7.6			5.4			3.9					
44.0	8.9	9.4		7.6			5.4			3.8					
46.0	8.7	9.3		7.5	7.6		5.4			3.8					
48.0	8.4	9.1		7.5	7.5		5.4	5.5		3.7					
50.0	8.2	8.9		7.5	7.5		5.4	5.4		3.7					
54.0	7.6	8.4		7.1	7.0		5.4	5.1		3.7	3.4				
58.0	7.1	7.8	6.5	6.8	6.3		5.3	4.5		3.6	2.9				
62.0	6.6	7.2	6.0	6.4	5.6	4.8	5.1	4.0	3.1	3.4	2.4				
66.0	6.1	6.8	5.5	6.0	5.0	4.2	4.6	3.5	2.6	3.0	2.1				
70.0		6.2	4.8		4.5	3.7		3.1	2.2		1.7				
74.0		5.7	4.2		4.1	3.3		2.7	1.9		1.5				
78.0			3.6			2.8			1.6						

MB + LJ

Tragfähigkeiten
Lifting capacities
Capacités de levage
Capacidades de elevación



 --- m	15.0 m + 2.5 m + 64.0 m			20.1 m + 2.5 m + 64.0 m			25.1 m + 2.5 m + 64.0 m			30.2 m + 2.5 m + 64.0 m			35.3 m + 2.5 m + 64.0 m		
	83°	75°	68°	83°	75°	68°	83°	75°	68°	83°	75°	68°	83°	75°	68°
24.0	19.3			16.6											
26.0	19.1			16.4			15.8			14.7					
28.0	18.8			16.2			15.7			14.6			12.6		
30.0	18.6			16.0			15.5			14.4			12.5		
32.0	18.3			15.8			15.3			14.3			12.4		
34.0	18.1	18.2		15.7			15.2			14.2			12.3		
36.0	17.9	17.9		15.5	15.6		15.0			14.1			12.2		
38.0	17.7	17.6		15.4	15.4		14.9	14.7		13.9			12.1		
40.0	17.2	16.9		15.2	15.3		14.8	14.1		13.8	13.8		12.0		
42.0	16.6	16.2	15.9	15.1	14.9		14.6	13.5		13.7	13.2		11.9	11.7	
44.0	16.0	15.7	15.3	14.9	14.3		14.1	13.0		13.6	12.7		11.8	11.2	
46.0	15.5	15.1	14.8	14.5	13.8	13.2	13.6	12.5		13.5	12.1		11.7	10.7	
48.0	15.0	14.6	14.2	14.0	13.3	12.7	13.1	12.0	11.2	13.0	11.7		11.7	10.3	
50.0	14.5	14.1	13.8	13.6	12.8	12.2	12.6	11.6	10.7	12.5	11.2	10.1	11.5	9.9	
54.0	13.4	13.2	12.9	12.7	12.0	11.4	11.8	10.8	9.9	11.7	10.4	9.3	10.7	9.1	7.9
58.0	10.8	12.5	12.1	12.0	11.3	10.7	11.1	10.1	9.2	10.9	9.6	8.6	10.0	8.5	7.3
62.0	8.1	11.1	11.5	9.4	10.6	10.0	10.5	9.5	8.6	10.3	9.0	8.0	9.4	7.9	6.7
66.0			10.3		10.1	9.2		8.9	7.9		8.4	7.1	8.9	7.3	6.0
70.0									7.0		7.7	6.3		6.8	5.2
74.0											5.5				4.5



 --- m	40.4 m + 2.5 m + 64.0 m			45.4 m + 2.5 m + 64.0 m			50.5 m + 2.5 m + 64.0 m			55.6 m + 2.5 m + 64.0 m					
	83°	75°	68°	83°	75°	68°	83°	75°	68°	83°	75°	68°			
30.0	10.0														
32.0	9.9			7.8			5.4								
34.0	9.9			7.8			5.3			3.8					
36.0	9.8			7.7			5.3			3.7					
38.0	9.7			7.7			5.2			3.7					
40.0	9.7			7.6			5.2			3.7					
42.0	9.6			7.6			5.2			3.6					
44.0	9.5	9.6		7.5			5.2			3.6					
46.0	9.5	9.3		7.5	7.5		5.2			3.6					
48.0	9.4	8.9		7.4	7.5		5.2	5.3		3.6					
50.0	9.4	8.5		7.4	7.4		5.2	5.2		3.5					
54.0	9.3	7.9		7.3	6.7		5.2	4.8		3.5	3.0				
58.0	9.0	7.3	5.9	7.0	5.9		5.1	4.2		3.4	2.5				
62.0	8.4	6.8	5.4	6.4	5.3	4.4	4.7	3.6	2.7	3.0	2.1				
66.0	7.9	6.3	4.8	5.8	4.7	3.9	4.2	3.1	2.3	2.7	1.7				
70.0		5.8	4.1		4.2	3.2		2.7	1.9						
74.0		5.2	3.5		3.8	2.6		2.4	1.6						
78.0			3.0			2.1									

Tragfähigkeiten
Lifting capacities
Capacités de levage
Capacidades de elevación

138t

DIN/ISO/EN

--> m	15.0 m + 2.5 m + 70.0 m			20.1 m + 2.5 m + 70.0 m			25.1 m + 2.5 m + 70.0 m			30.2 m + 2.5 m + 70.0 m			35.3 m + 2.5 m + 70.0 m		
	83°	75°	68°	83°	75°	68°	83°	75°	68°	83°	75°	68°	83°	75°	68°
26.0	15.9														
28.0	15.7			14.8			13.8								
30.0	15.5			14.6			13.6			12.3					
32.0	15.4			14.5			13.5			12.2			10.6		
34.0	15.2			14.3			13.4			12.1			10.5		
36.0	14.9			14.1			13.3			12.0			10.4		
38.0	14.6	14.9		13.9			13.1			11.9			10.4		
40.0	14.2	14.6		13.6	13.7		12.9	13.1		11.8			10.3		
42.0	13.6	14.1		13.3	13.1		12.7	12.8		11.7	11.6		10.2		
44.0	13.1	13.7		12.8	12.7		12.4	12.2		11.6	11.1		10.1		
46.0	12.5	13.1	13.1	12.4	12.2		12.1	11.8		11.5	10.7		10.1	9.3	
48.0	12.0	12.6	12.7	12.0	11.8		11.7	11.3		11.3	10.3		10.0	8.9	
50.0	11.6	12.1	12.3	11.6	11.4	10.8	11.4	10.9		11.1	9.9		9.9	8.6	
54.0	10.7	11.2	11.5	10.7	10.7	10.1	10.7	10.1	9.3	10.5	9.2	8.1	9.5	7.9	
58.0	9.9	10.4	10.8	10.0	10.0	9.4	10.0	9.5	8.6	9.8	8.5	7.5	8.8	7.3	6.1
62.0	9.3	9.7	10.0	9.3	9.5	8.9	9.4	8.9	8.0	9.2	7.9	6.9	8.3	6.8	5.7
66.0	7.9	9.0	9.3	8.7	9.0	8.4	8.8	8.3	7.5	8.7	7.4	6.4	7.8	6.4	5.2
70.0		8.2	8.7		8.6	7.7	7.7	7.9	6.7	8.2	7.0	5.7	7.4	5.9	4.5
74.0						6.9		7.0	5.9		6.3	5.0		5.4	3.9
78.0												4.3		4.7	3.3
82.0															2.8

138t

DIN/ISO/EN

--> m	40.4 m + 2.5 m + 70.0 m			45.4 m + 2.5 m + 70.0 m			50.5 m + 2.5 m + 70.0 m								
	83°	75°	68°	83°	75°	68°	83°	75°	68°						
32.0	8.4														
34.0	8.4			6.3											
36.0	8.3			6.3			4.5								
38.0	8.3			6.2			4.5								
40.0	8.2			6.2			4.4								
42.0	8.1			6.1			4.3								
44.0	8.1			6.1			4.3								
46.0	8.0			6.1			4.3								
48.0	8.0	7.7		6.1			4.2								
50.0	8.0	7.4		6.1	6.1		4.2								
54.0	7.9	6.8		6.0	6.1		4.1	4.2							
58.0	7.9	6.3		6.0	5.7		4.0	3.9							
62.0	7.4	5.8	4.5	6.0	5.1	4.0	4.0	3.4							
66.0	7.0	5.4	4.1	5.6	4.5	3.5	4.0	2.9	2.0						
70.0	6.6	5.0	3.5	5.1	4.0	2.9	3.6	2.5	1.6						
74.0		4.6	2.9		3.6	2.4	3.2	2.1							
78.0		4.0	2.4		3.2	1.8		1.8							
82.0			1.9					1.6							

MB + LJ

Tragfähigkeiten
Lifting capacities
Capacités de levage
Capacidades de elevación



 ---> m	15.0 m + 2.5 m + 76.0 m			20.1 m + 2.5 m + 76.0 m			25.1 m + 2.5 m + 76.0 m			30.2 m + 2.5 m + 76.0 m			35.3 m + 2.5 m + 76.0 m		
	83°	75°	68°	83°	75°	68°	83°	75°	68°	83°	75°	68°	83°	75°	68°
28.0	12.8														
30.0	12.7			12.1			11.5								
32.0	12.5			12.0			11.4			10.3					
34.0	12.2			11.7			11.2			10.2			8.9		
36.0	11.9			11.4			10.9			10.1			8.8		
38.0	11.5			11.1			10.7			10.0			8.8		
40.0	11.1	11.6		10.8			10.4			9.9			8.7		
42.0	10.6	11.1		10.4	10.9		10.1			9.7			8.6		
44.0	10.2	10.7		10.1	10.5		9.8	10.3		9.5			8.6		
46.0	9.8	10.3		9.7	10.2		9.5	10.0		9.2	9.0		8.5		
48.0	9.4	9.9		9.4	9.8		9.2	9.6		9.0	8.6		8.4	7.3	
50.0	9.1	9.5	9.9	9.0	9.5		8.9	9.3		8.7	8.3		8.2	7.0	
54.0	8.4	8.8	9.1	8.4	8.8	8.5	8.3	8.6		8.2	7.7		7.9	6.5	
58.0	7.8	8.1	8.4	7.8	8.2	8.0	7.8	8.1	7.2	7.7	7.1	6.1	7.5	6.0	
62.0	7.2	7.5	7.8	7.3	7.7	7.5	7.3	7.5	6.7	7.3	6.6	5.6	7.0	5.5	4.4
66.0	6.7	7.0	7.3	6.8	7.1	7.1	6.8	7.1	6.2	6.8	6.2	5.2	6.6	5.1	4.0
70.0	6.3	6.6	6.8	6.3	6.7	6.7	6.4	6.7	5.8	6.4	5.8	4.8	6.2	4.8	3.5
74.0	5.5	6.1	6.3	5.9	6.2	6.1	6.0	6.2	5.1	6.0	5.4	4.1	5.9	4.5	2.9
78.0			5.9		5.9	5.4		5.5	4.4		4.7	3.5		3.8	2.4
82.0								3.8			4.1	2.9		3.3	1.9



 ---> m	40.4 m + 2.5 m + 76.0 m			45.4 m + 2.5 m + 76.0 m										
	83°	75°	68°	83°	75°	68°								
36.0	6.9			5.1										
38.0	6.9			5.0										
40.0	6.8			5.0										
42.0	6.8			5.0										
44.0	6.7			5.0										
46.0	6.7			5.0										
48.0	6.7			4.9										
50.0	6.6	6.2		4.9										
54.0	6.5	5.6		4.8	4.9									
58.0	6.5	5.2		4.7	4.7									
62.0	6.4	4.8		4.7	4.5									
66.0	6.0	4.4	3.1	4.7	4.1	2.6								
70.0	5.6	4.0	2.6	4.7	3.7	2.0								
74.0	5.3	3.7	2.0	4.3	3.2	1.5								
78.0	5.0	3.2	1.5	4.0	2.8									
82.0		2.6			2.3									
86.0		2.1			1.8									

Tragfähigkeiten
Lifting capacities
Capacités de levage
Capacidades de elevación

				78t	DIN/ISO/EN
--	---	---	---	------------	-------------------

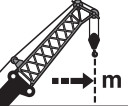
	15.0 m + 2.5 m + 20.3 m			20.1 m + 2.5 m + 20.3 m			25.1 m + 2.5 m + 20.3 m			30.2 m + 2.5 m + 20.3 m			35.3 m + 2.5 m + 20.3 m		
	83°	75°	68°	83°	75°	68°	83°	75°	68°	83°	75°	68°	83°	75°	68°
12.0	74.4														
14.0	70.1			65.6			61.2								
16.0	59.5	57.5		57.1			53.4			50.2					
18.0	51.2	49.4		50.0	47.1		47.3			44.5			41.7		
20.0	42.2	43.2	41.7	43.7	41.2		42.4	38.5		40.0			37.4		
22.0		38.3	37.0		36.5		37.7	34.6		36.3	32.2		34.0		
24.0			33.5		32.7	30.9		31.0			29.4			26.7	
26.0						27.8		27.9	25.4		26.4			24.5	
28.0									22.9			21.1		22.4	
30.0												19.2			17.4
32.0															15.9

				78t	DIN/ISO/EN
--	---	---	---	------------	-------------------

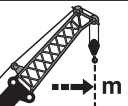
	40.4 m + 2.5 m + 20.3 m			45.4 m + 2.5 m + 20.3 m									
	83°	75°	68°	83°	75°	68°							
18.0	39.0												
20.0	35.1			30.7									
22.0	31.8			28.1									
24.0	29.1			24.1									
26.0		22.2											
28.0		20.5											
30.0		19.0			17.2								
32.0													
34.0			13.1										
36.0						10.8							

Tragfähigkeiten
Lifting capacities
Capacités de levage
Capacidades de elevación



	15.0 m + 2.5 m + 32.3 m			20.1 m + 2.5 m + 32.3 m			25.1 m + 2.5 m + 32.3 m			30.2 m + 2.5 m + 32.3 m			35.3 m + 2.5 m + 32.3 m		
	83°	75°	68°	83°	75°	68°	83°	75°	68°	83°	75°	68°	83°	75°	68°
12.0	61.2														
14.0	59.6			49.5			43.5								
16.0	55.0			47.9			42.6			38.1					
18.0	48.5			45.4			41.8			37.5			32.4		
20.0	43.1	41.4		40.6	37.8		37.8			35.5			31.9		
22.0	38.1	36.6		36.7	34.1		34.2	30.8		32.1			29.7		
24.0	34.1	32.7	31.4	33.0	30.6		31.2	28.0		29.2	25.4		27.1		
26.0	30.9	29.4	28.2	29.7	27.4	25.6	28.5	25.7		26.8	23.2		24.8		
28.0	28.0	26.6	25.5	26.9	24.8	23.1	25.8	23.3		24.7	21.4		22.9	18.9	
30.0	25.6	24.3	23.2	24.5	22.6	21.0	23.5	21.2	18.7	22.8	19.7		21.2	17.5	
32.0	20.4	22.3	21.5	22.5	20.7	19.2	21.6	19.3	17.1	20.8	18.1	15.3	19.7	16.2	
34.0		20.5	19.8		19.1	17.7	19.9	17.8	15.6	19.2	16.6	14.0	18.3	15.0	12.2
36.0			18.2			17.8	16.3	16.4	14.4		15.3	12.9		13.9	11.2
38.0						15.1		15.2	13.3		14.1	11.9		12.9	10.3
40.0									12.3			11.0		11.9	9.5
42.0												10.2			8.8
44.0															8.1

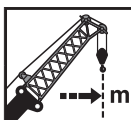

	40.4 m + 2.5 m + 32.3 m			45.4 m + 2.5 m + 32.3 m			50.5 m + 2.5 m + 32.3 m								
	83°	75°	68°	83°	75°	68°	83°	75°	68°						
20.0	22.5														
22.0	22.1			17.8			13.7								
24.0	21.7			17.7			13.7								
26.0	21.3			17.4			13.7								
28.0	21.0			17.1			13.5								
30.0	19.6	15.3		16.9			13.3								
32.0	18.2	14.2		16.1	12.4		13.2								
34.0	16.9	13.2		15.1	11.5		12.9	10.6							
36.0	15.8	12.2		14.2	10.7		11.8	9.8							
38.0		11.4	8.6		9.9			9.1							
40.0		10.6	8.0		9.2	6.3		8.5							
42.0		9.8	7.3		8.6	5.8		7.9							
44.0			6.7			5.4		7.4	4.5						
46.0			6.2			5.0			4.2						
48.0						4.6			3.8						
50.0									3.5						





78t

DIN/ISO/EN

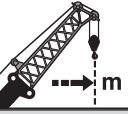
 m	15.0 m + 2.5 m + 34.0 m			20.1 m + 2.5 m + 34.0 m			25.1 m + 2.5 m + 34.0 m			30.2 m + 2.5 m + 34.0 m			35.3 m + 2.5 m + 34.0 m		
	83°	75°	68°	83°	75°	68°	83°	75°	68°	83°	75°	68°	83°	75°	68°
14.0	53.2			46.1											
16.0	48.3			45.0			40.1			35.7					
18.0	44.1			43.6			39.4			35.1			29.5		
20.0	40.6	40.8		39.9			37.1			34.6			29.1		
22.0	37.6	36.4		36.0	33.4		33.5			31.4			28.7		
24.0	33.9	32.5		32.7	30.3		30.5	27.4		28.6			26.4		
26.0	30.6	29.1	28.1	29.4	27.2		28.0	25.1		26.2	22.6		24.2		
28.0	27.8	26.4	25.3	26.6	24.6	22.8	25.5	22.8		24.1	20.8		22.2	18.3	
30.0	25.4	24.0	23.2	24.3	22.4	20.7	23.2	20.8	18.3	22.3	19.2		20.6	16.9	
32.0	23.3	22.0	21.2	22.3	20.5	18.9	21.2	19.0	16.6	20.5	17.6	14.9	19.1	15.6	
34.0		20.3	19.5	20.5	18.8	17.4	19.5	17.4	15.2	18.8	16.2	13.6	17.8	14.5	
36.0		18.8	18.0		17.4	16.0		16.0	14.0	17.4	14.9	12.5	16.5	13.5	10.8
38.0			16.7		16.3	14.8		14.8	12.9		13.7	11.5	12.4	9.9	
40.0					13.7			13.7	11.9		12.7	10.6	11.5	9.1	
42.0									11.1			9.8	10.6	8.3	
44.0												9.1		7.7	
46.0														7.1	





78t

DIN/ISO/EN

 m	40.4 m + 2.5 m + 34.0 m			45.4 m + 2.5 m + 34.0 m			50.5 m + 2.5 m + 34.0 m			55.6 m + 2.5 m + 34.0 m					
	83°	75°	68°	83°	75°	68°	83°	75°	68°	83°	75°	68°			
20.0	21.3														
22.0	20.9			17.0											
24.0	20.5			16.5			13.0			9.2					
26.0	20.2			16.2			12.8			9.0					
28.0	19.9			16.1			12.7			8.7					
30.0	19.0	14.8		15.9			12.6			8.6					
32.0	17.6	13.6		15.8	11.8		12.6			8.5					
34.0	16.4	12.6		15.0	10.9		12.5	9.7		8.5					
36.0	15.3	11.7		14.0	10.1		11.9	8.9		8.5					
38.0	14.3	10.9	8.1	13.1	9.4		11.0	8.3		8.5	7.7				
40.0		10.2	7.5		8.7			7.7		8.1	7.1				
42.0		9.4	6.9		8.1	5.3		7.1			6.6				
44.0		8.7	6.3		7.5	4.9		6.6	3.8		6.1				
46.0			5.8			4.5		6.1	3.4		5.6				
48.0			5.3			4.1			3.1		5.2	2.4			
50.0						3.7			2.7			2.1			
54.0												1.6			

MB + LJ

Tragfähigkeiten
Lifting capacities
Capacités de levage
Capacidades de elevación



 --- m	15.0 m + 2.5 m + 40.0 m			20.1 m + 2.5 m + 40.0 m			25.1 m + 2.5 m + 40.0 m			30.2 m + 2.5 m + 40.0 m			35.3 m + 2.5 m + 40.0 m			
	83°	75°	68°	83°	75°	68°	83°	75°	68°	83°	75°	68°	83°	75°	68°	
14.0	36.7															
16.0	33.2			33.2												
18.0	30.3			30.4			30.3									
20.0	27.5			28.0			28.2			20.6				21.8		
22.0	24.4	27.5		25.1			26.0			20.3				21.4		
24.0	22.1	24.3		22.3	26.0		23.1			19.8				21.0		
26.0	20.3	22.3		20.7	23.2		21.0	23.6		19.0				20.4		
28.0	18.8	20.6	22.2	19.2	21.4		19.5	21.7		18.0	19.3			19.6		
30.0	17.5	19.0	20.5	17.8	19.9		18.1	20.0		17.0	17.8			18.5	15.6	
32.0	16.3	17.7	19.0	16.6	18.4	18.5	16.9	18.3		16.0	16.5			17.4	14.4	
34.0	15.2	16.5	17.6	15.5	17.2	16.9	15.8	16.8	14.5	15.1	15.3			16.4	13.3	
36.0	14.3	15.4	16.4	14.5	16.0	15.6	14.8	15.4	13.3	14.2	14.1	11.7		15.4	12.4	
38.0	13.4	14.4	15.4	13.6	15.0	14.4	13.9	14.2	12.3	13.5	13.0	10.7		14.5	11.5	
40.0		13.5	14.4	12.8	14.1	13.4	13.1	13.2	11.3	12.7	12.0	9.9		13.7	10.8	8.2
42.0		12.8	13.5		13.2	12.4		12.2	10.5	12.1	11.1	9.1		12.7	9.9	7.6
44.0					12.5	11.5		11.4	9.7		10.3	8.4			9.2	6.9
46.0						10.8			9.0		9.6	7.8			8.5	6.4
48.0									8.4			7.2			7.9	5.9
50.0												6.7				5.4

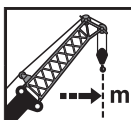

 --- m	40.4 m + 2.5 m + 40.0 m			45.4 m + 2.5 m + 40.0 m			50.5 m + 2.5 m + 40.0 m			55.6 m + 2.5 m + 40.0 m					
	83°	75°	68°	83°	75°	68°	83°	75°	68°	83°	75°	68°			
24.0	17.5			14.5											
26.0	17.0			14.3			11.7			9.4					
28.0	16.7			14.1			11.2			9.3					
30.0	16.4			14.1			10.9			9.2					
32.0	16.1			14.0			10.9			9.1					
34.0	15.0	11.1		13.9			10.9			8.9					
36.0	13.9	10.3		13.1	9.2		10.9			8.7					
38.0	13.0	9.5		12.2	8.5		10.7	7.4		8.4					
40.0	12.2	8.9		11.4	7.8		10.3	6.9		7.9	6.3				
42.0	11.4	8.2	5.7	10.7	7.3		9.7	6.3		7.4	5.8				
44.0	10.7	7.7	5.2	10.0	6.7		9.2	5.9		7.0	5.4				
46.0		7.1	4.8		6.3	3.7		5.4			5.0				
48.0		6.6	4.4		5.8	3.3		5.0	2.3		4.6				
50.0		6.2	4.0		5.4	3.0		4.6	2.0		4.2	1.5			
54.0			3.3			2.4			1.5		3.5				

78t

DIN/ISO/EN

--> m	15.0 m + 2.5 m + 46.0 m			20.1 m + 2.5 m + 46.0 m			25.1 m + 2.5 m + 46.0 m			30.2 m + 2.5 m + 46.0 m			35.3 m + 2.5 m + 46.0 m		
	83°	75°	68°	83°	75°	68°	83°	75°	68°	83°	75°	68°	83°	75°	68°
16.0	25.8														
18.0	22.8			23.1											
20.0	20.6			20.6			20.5								
22.0	18.9			19.0			19.1			18.9			18.2		
24.0	17.4	19.1		17.5			17.7			17.7			17.8		
26.0	16.0	17.6		16.2	18.1		16.4			16.5			16.9		
28.0	14.8	16.2		15.0	16.8		15.2			15.4			15.9		
30.0	13.8	15.0		13.9	15.6		14.2	16.1		14.4			15.0		
32.0	12.8	13.9	14.9	13.0	14.4		13.2	15.0		13.5	15.5		14.0		
34.0	12.0	12.9	13.8	12.1	13.5	14.7	12.4	14.0		12.6	14.3		13.2	12.3	
36.0	11.2	12.1	12.9	11.4	12.5	13.6	11.6	13.1		11.8	13.3		12.4	11.4	
38.0	10.5	11.3	12.0	10.7	11.7	12.8	10.9	12.2	11.8	11.1	12.4		11.6	10.6	
40.0	9.8	10.6	11.3	10.0	11.0	11.9	10.2	11.4	10.9	10.4	11.4	9.2	10.9	9.9	
42.0	9.3	9.9	10.6	9.4	10.3	11.2	9.6	10.8	10.1	9.8	10.6	8.5	10.3	9.2	
44.0	8.7	9.4	9.9	8.9	9.7	10.5	9.1	10.1	9.4	9.2	9.8	7.8	9.7	8.6	6.3
46.0		8.8	9.3	8.4	9.2	9.9	8.6	9.5	8.7	8.7	9.1	7.2	9.1	8.0	5.8
48.0		8.3	8.8		8.6	9.3		9.0	8.1		8.5	6.7	8.6	7.5	5.4
50.0						8.8		8.5	7.5		7.9	6.2		6.9	4.9
54.0									6.5			5.3		6.0	4.1
58.0															3.5

78t

DIN/ISO/EN

--> m	40.4 m + 2.5 m + 46.0 m			45.4 m + 2.5 m + 46.0 m			50.5 m + 2.5 m + 46.0 m			55.6 m + 2.5 m + 46.0 m					
	83°	75°	68°	83°	75°	68°	83°	75°	68°	83°	75°	68°			
26.0	15.1			12.7			10.2								
28.0	14.8			12.6			10.1			7.8					
30.0	14.4			12.5			10.0			7.7					
32.0	13.8			12.4			9.8			7.6					
34.0	13.2			12.2			9.8			7.5					
36.0	12.6	9.4		11.9			9.7			7.4					
38.0	11.9	8.7		11.5	7.7		9.6			7.4					
40.0	11.3	8.0		10.7	7.1		9.5	6.6		7.3					
42.0	10.6	7.4		10.0	6.6		9.3	6.1		7.2					
44.0	10.0	6.9		9.4	6.1		9.0	5.6		6.8	4.5				
46.0	9.3	6.4	4.0	8.8	5.6		8.5	5.2		6.4	4.1				
48.0	8.8	6.0	3.7	8.3	5.2	2.7	8.1	4.8		6.1	3.8				
50.0		5.5	3.3	7.8	4.8	2.4	7.6	4.4		5.7	3.4				
54.0		4.8	2.7		4.1	1.8		3.7			2.8				
58.0			2.2					3.1			2.3				

MB + LJ

Tragfähigkeiten
Lifting capacities
Capacités de levage
Capacidades de elevación



 --- m	15.0 m + 2.5 m + 46.0 m			20.1 m + 2.5 m + 46.0 m			25.1 m + 2.5 m + 46.0 m			30.2 m + 2.5 m + 46.0 m			35.3 m + 2.5 m + 46.0 m		
	83°	75°	68°	83°	75°	68°	83°	75°	68°	83°	75°	68°	83°	75°	68°
16.0	36.7														
18.0	35.8			30.8											
20.0	35.1			30.2			23.7								
22.0	34.3			29.7			23.2			18.5			17.9		
24.0	32.0			29.2			22.8			18.2			17.6		
26.0	29.2	27.6		27.0			22.4			17.9			17.4		
28.0	26.3	24.9		24.9	22.8		22.0			17.7			17.1		
30.0	23.9	22.6		22.7	20.9		21.0	18.4		17.4			16.9		
32.0	21.9	20.6	19.6	20.7	19.0		19.5	17.0		17.2	14.4		16.4		
34.0	20.1	18.9	18.0	19.0	17.4	15.6	18.0	15.7		16.3	13.3		15.2	11.6	
36.0	18.5	17.4	16.5	17.5	16.0	14.3	16.6	14.4		15.1	12.3		14.1	10.8	
38.0	17.2	16.1	15.2	16.2	14.7	13.2	15.3	13.3	11.2	14.1	11.4		13.1	9.9	
40.0	15.9	14.9	14.1	15.0	13.6	12.2	14.2	12.2	10.3	13.0	10.5	8.3	12.3	9.2	
42.0	14.8	13.8	13.1	13.9	12.6	11.2	13.2	11.3	9.5	12.1	9.7	7.6	11.5	8.5	6.1
44.0	13.8	12.9	12.2	13.0	11.7	10.4	12.2	10.5	8.8	11.2	9.0	6.9	10.7	7.9	5.6
46.0		12.1	11.3	12.1	10.9	9.7	11.4	9.7	8.1	10.5	8.3	6.4	10.1	7.4	5.2
48.0		11.3	10.6		10.2	9.0		9.0	7.5	9.8	7.6	5.8	9.4	6.9	4.7
50.0						8.4		8.4	6.9	9.8	7.1	5.3	9.4	6.4	4.3
54.0									5.9			4.5		5.4	3.6
58.0															2.9

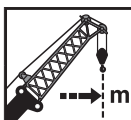

 --- m	40.4 m + 2.5 m + 46.0 m			45.4 m + 2.5 m + 46.0 m			50.5 m + 2.5 m + 46.0 m			55.6 m + 2.5 m + 46.0 m					
	83°	75°	68°	83°	75°	68°	83°	75°	68°	83°	75°	68°			
26.0	14.9			12.9			10.1								
28.0	14.8			12.8			10.0			7.7					
30.0	14.6			12.7			9.9			7.5					
32.0	14.4			12.5			9.8			7.5					
34.0	13.4			12.3			9.7			7.4					
36.0	12.4	8.7		11.6			9.6			7.3					
38.0	11.5	8.0		10.8	6.9		9.6			7.2					
40.0	10.7	7.4		10.0	6.3		9.5	6.0		7.1					
42.0	10.0	6.8		9.3	5.8		9.1	5.5		6.9	4.2				
44.0	9.3	6.3		8.7	5.3		8.7	5.0		6.5	3.7				
46.0	8.7	5.8	3.4	8.1	4.9		8.1	4.6		6.1	3.4				
48.0	8.1	5.3	3.0	7.6	4.4	1.9	7.5	4.2		5.7	3.0				
50.0		4.9	2.7	7.0	4.1	1.6	7.0	3.8		5.4	2.7				
54.0		4.1	2.0		3.4			3.1			2.1				
58.0			1.5					2.5			1.5				

Tragfähigkeiten
Lifting capacities
Capacités de levage
Capacidades de elevación

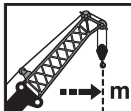

 m	15.0 m + 2.5 m + 52.0 m			20.1 m + 2.5 m + 52.0 m			25.1 m + 2.5 m + 52.0 m			30.2 m + 2.5 m + 52.0 m			35.3 m + 2.5 m + 52.0 m		
	83°	75°	68°	83°	75°	68°	83°	75°	68°	83°	75°	68°	83°	75°	68°
18.0	18.8														
20.0	17.2			17.1											
22.0	15.8			15.8			15.8								
24.0	14.6			14.6			14.7			14.6					
26.0	13.5			13.5			13.7			13.7			13.9		
28.0	12.5	13.6		12.6			12.7			12.8			13.2		
30.0	11.6	12.6		11.7	13.0		11.9			12.0			12.5		
32.0	10.8	11.7		10.9	12.1		11.1	12.5		11.2			11.9		
34.0	10.1	10.8		10.2	11.3		10.3	11.6		10.5	12.0		11.2		
36.0	9.4	10.2	10.8	9.5	10.5		9.7	10.9		9.8	11.3		10.5		
38.0	8.8	9.5	10.1	8.9	9.8	10.7	9.1	10.2		9.2	10.6		9.9	9.3	
40.0	8.3	8.9	9.5	8.4	9.2	10.0	8.5	9.6	10.4	8.7	9.9		9.3	8.7	
42.0	7.8	8.3	8.9	7.9	8.6	9.3	8.0	9.0	9.6	8.2	9.3		8.7	8.0	
44.0	7.3	7.8	8.3	7.4	8.1	8.8	7.6	8.4	8.8	7.7	8.8	7.2	8.2	7.5	
46.0	6.9	7.4	7.8	7.0	7.6	8.2	7.1	7.9	8.2	7.3	8.2	6.6	7.8	6.9	4.7
48.0	6.5	7.0	7.4	6.6	7.2	7.8	6.7	7.5	7.6	6.9	7.8	6.1	7.3	6.4	4.3
50.0	6.2	6.6	6.9	6.3	6.8	7.3	6.4	7.1	7.0	6.5	7.3	5.6	6.9	6.0	4.0
54.0		5.9	6.2		6.1	6.5		6.3		6.1		6.4	4.8	6.2	5.2
58.0									5.2			5.5	4.0		4.4
62.0												3.4			2.1

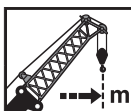

 m	40.4 m + 2.5 m + 52.0 m			45.4 m + 2.5 m + 52.0 m			50.5 m + 2.5 m + 52.0 m			55.6 m + 2.5 m + 52.0 m					
	83°	75°	68°	83°	75°	68°	83°	75°	68°	83°	75°	68°			
26.0	12.8														
28.0	12.5			10.8			8.5								
30.0	12.0			10.7			8.4			6.2					
32.0	11.5			10.4			8.3			6.1					
34.0	11.0			10.2			8.2			6.1					
36.0	10.4			9.8			8.1			6.0					
38.0	9.9			9.5			8.1			6.0					
40.0	9.4	7.2		9.1	6.6		8.0			5.9					
42.0	8.8	6.6		8.7	6.1		7.9			5.9					
44.0	8.4	6.1		8.3	5.6		7.7	4.5		5.9					
46.0	7.9	5.6		7.9	5.1		7.5	4.1		5.9	3.2				
48.0	7.5	5.2		7.6	4.7		7.0	3.7		5.8	2.9				
50.0	7.1	4.8	2.6	7.2	4.3		6.6	3.4		5.6	2.6				
54.0	6.3	4.1	2.0	6.5	3.7		5.7	2.7		5.0	2.0				
58.0		3.4	1.5		3.1			2.2			1.5				
62.0		2.9			2.5			1.7							

MB + LJ

Tragfähigkeiten
Lifting capacities
Capacités de levage
Capacidades de elevación



 m	15.0 m + 2.5 m + 52.0 m			20.1 m + 2.5 m + 52.0 m			25.1 m + 2.5 m + 52.0 m			30.2 m + 2.5 m + 52.0 m			35.3 m + 2.5 m + 52.0 m		
	83°	75°	68°	83°	75°	68°	83°	75°	68°	83°	75°	68°	83°	75°	68°
18.0	29.8														
20.0	29.2			22.3											
22.0	27.8			21.9			19.6								
24.0	25.4			21.5			19.3			14.8			16.0		
26.0	23.5			21.1			18.9			14.7			15.9		
28.0	22.2	24.2		20.7			18.6			14.6			15.7		
30.0	21.0	22.0		20.4	19.8		18.4			14.5			15.6		
32.0	19.8	20.0		19.5	18.3		18.1	15.7		14.5			15.2		
34.0	18.8	18.3		18.4	16.7		17.0	14.5		14.4	12.5		14.0		
36.0	17.8	16.9	15.9	16.9	15.3		15.8	13.5		14.3	11.5		13.0	9.6	
38.0	16.7	15.5	14.6	15.6	14.1	12.5	14.7	12.5		13.4	10.7		12.1	8.9	
40.0	15.4	14.4	13.5	14.4	13.0	11.5	13.6	11.6	9.6	12.5	9.9		11.3	8.2	
42.0	14.4	13.3	12.5	13.4	12.0	10.6	12.6	10.7	8.8	11.7	9.2		10.5	7.5	
44.0	13.4	12.4	11.6	12.5	11.2	9.8	11.7	9.9	8.1	10.9	8.5	6.5	9.8	7.0	
46.0	12.5	11.6	10.8	11.6	10.4	9.1	10.9	9.1	7.5	10.1	7.9	6.0	9.2	6.4	4.2
48.0	11.7	10.8	10.1	10.8	9.7	8.4	10.2	8.5	6.9	9.4	7.3	5.5	8.6	5.9	3.8
50.0	10.9	10.1	9.4	10.1	9.0	7.8	9.5	7.9	6.3	8.9	6.8	5.0	8.0	5.5	3.4
54.0		9.0	8.2		7.8	6.7		6.8	5.4	7.7	5.8	4.1	7.0	4.7	2.8
58.0									4.6		4.9	3.4		4.0	2.2
62.0											2.8				1.6

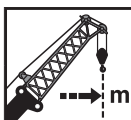

 m	40.4 m + 2.5 m + 52.0 m			45.4 m + 2.5 m + 52.0 m			50.5 m + 2.5 m + 52.0 m			55.6 m + 2.5 m + 52.0 m					
	83°	75°	68°	83°	75°	68°	83°	75°	68°	83°	75°	68°			
26.0	13.8														
28.0	13.7			11.2			8.6								
30.0	13.6			11.1			8.5			6.1					
32.0	13.4			11.0			8.4			6.0					
34.0	12.4			10.9			8.3			6.0					
36.0	11.4			10.8			8.2			6.0					
38.0	10.6			10.3			8.2			6.0					
40.0	9.8	6.4		9.6	5.9		8.1			5.9					
42.0	9.1	5.9		8.9	5.3		8.0			5.8					
44.0	8.5	5.4		8.3	4.9		7.4	3.7		5.8					
46.0	7.9	4.9		7.7	4.4		6.8	3.3		5.8	2.6				
48.0	7.4	4.5		7.2	4.0		6.4	3.0		5.6	2.2				
50.0	6.9	4.1	1.8	6.7	3.6		5.9	2.6		5.3	1.9				
54.0	6.0	3.4		5.8	3.0		5.1	2.0		4.6					
58.0		2.7			2.4			1.5							
62.0		2.2			1.8										



UNIVERSAL
SALE & RENTAL

Hubhöhen
Lifting heights
Hauteurs de levage
Alturas de elevación



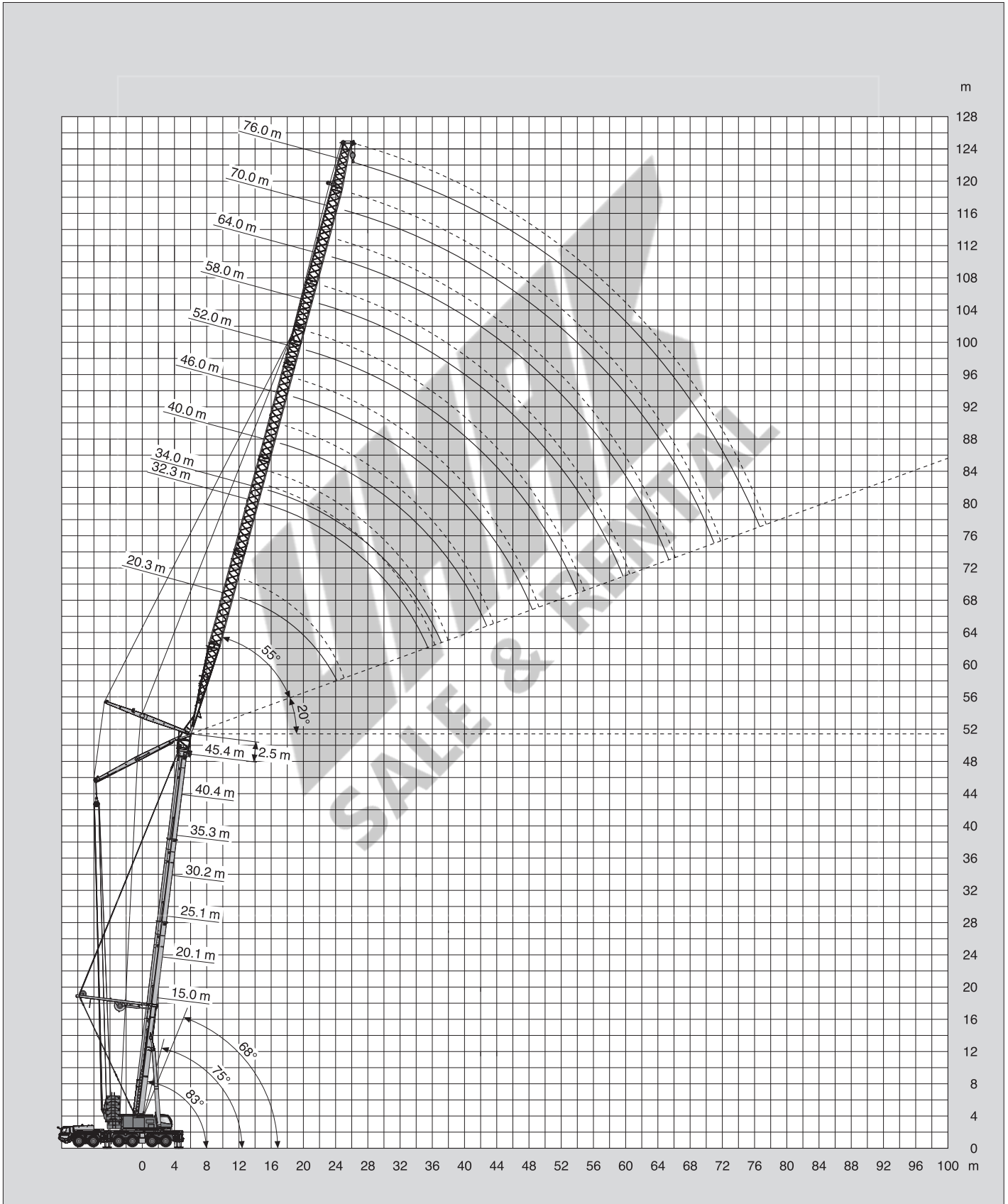

DIN/ISO/EN

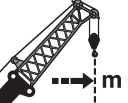

					138t	DIN/ISO/EN
--	---	---	---	---	-------------	-------------------

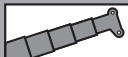
	35.3 m + 2.5 m + 20.3 m			40.4 m + 2.5 m + 20.3 m			45.4 m + 2.5 m + 20.3 m								
	83°	75°	68°	83°	75°	68°	83°	75°	68°						
16.0	39.8														
18.0	35.5			31.1											
20.0	31.7			27.6			26.7								
22.0	28.0			22.0			21.5								
24.0		30.1		18.7			18.5								
26.0		27.2			21.4										
28.0		21.3			19.0										
30.0			22.8		16.5			16.4							
32.0			20.3												
34.0						15.9									
36.0													14.0		

					138t	DIN/ISO/EN
--	---	---	---	---	-------------	-------------------

	35.3 m + 2.5 m + 32.3 m			40.4 m + 2.5 m + 32.3 m			45.4 m + 2.5 m + 32.3 m			50.5 m + 2.5 m + 32.3 m					
	83°	75°	68°	83°	75°	68°	83°	75°	68°	83°	75°	68°			
18.0	30.8														
20.0	30.3			20.8											
22.0	29.4			20.3			16.5					12.5			
24.0	26.9			19.9			16.1					12.1			
26.0	22.4			19.0			15.8					11.9			
28.0	20.4	22.8		17.5			15.6					11.7			
30.0	18.6	20.9		16.0	17.7		15.3					11.6			
32.0	16.9	19.3		14.5	16.2		13.9	15.1				11.3			
34.0	15.2	17.8	19.2	13.1	15.0		12.5	14.2				11.0	11.5		
36.0		16.3	17.8		13.8		11.1	13.0				11.0	11.2		
38.0		14.9	16.5		12.6	13.7		12.0					10.9		
40.0		13.4	15.3		11.5	12.7		11.0	11.9				10.7		
42.0			14.1		10.3	11.7		9.9	11.0				10.2		
44.0			12.9			10.8			10.2				9.1	10.6	
46.0						9.9			9.4					9.4	
48.0									8.6					8.6	
50.0														7.9	

MB
+ LJ+PS

Tragfähigkeiten
Lifting capacities
Capacités de levage
Capacidades de elevación



	35.3 m + 2.5 m + 34.0 m			40.4 m + 2.5 m + 34.0 m			45.4 m + 2.5 m + 34.0 m			50.5 m + 2.5 m + 34.0 m			55.6 m + 2.5 m + 34.0 m		
	83°	75°	68°	83°	75°	68°	83°	75°	68°	83°	75°	68°	83°	75°	68°
18.0	27.8														
20.0	24.4			19.8											
22.0	22.8			19.3			15.6								
24.0	21.2			18.9			15.2			11.5			7.9		
26.0	19.4			18.4			15.0			11.4			7.7		
28.0	17.7	21.2		17.6			14.7			11.4			7.7		
30.0	16.1	19.5		16.1	17.5		14.4			11.1			7.7		
32.0	14.6	18.0		14.6	16.3		13.8	14.4		11.0			7.7		
34.0	12.9	16.6		13.3	15.0		12.7	14.1		10.7	11.1		7.7		
36.0		15.3	17.5	12.0	13.8		11.4	13.2		10.6	10.8		7.5	7.2	
38.0		14.0	16.2		12.7	13.6	10.1	12.0		10.4	10.5		7.2	7.2	
40.0		12.8	15.0		11.7	12.6		11.0			10.5			7.0	
42.0		11.4	13.9		10.6	11.7		10.1	11.0		10.1			7.0	
44.0			12.9			10.8		9.1	10.1		9.3	10.3		7.0	
46.0			11.8			10.0			9.4		8.3	9.3		6.6	6.9
48.0						9.1			8.6			8.6		6.4	6.7
50.0									7.8			7.9		6.4	6.4
54.0														6.4	6.4

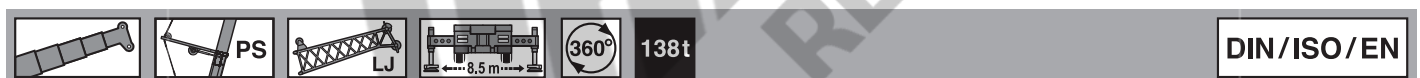

	35.3 m + 2.5 m + 40.0 m			40.4 m + 2.5 m + 40.0 m			45.4 m + 2.5 m + 40.0 m			50.5 m + 2.5 m + 40.0 m			55.6 m + 2.5 m + 40.0 m		
	83°	75°	68°	83°	75°	68°	83°	75°	68°	83°	75°	68°	83°	75°	68°
20.0	20.8														
22.0	20.4			17.2											
24.0	20.0			16.8			13.4								
26.0	19.6			16.5			13.2			10.3			8.2		
28.0	18.7			16.2			13.1			10.3			8.0		
30.0	17.7	19.1		15.9			13.0			10.2			7.8		
32.0	16.7	18.8		15.6			12.8			10.0			7.7		
34.0	15.7	18.1		15.0	15.4		12.7			9.8			7.5		
36.0	14.8	17.0		14.1	15.0		12.4	12.6		9.7			7.3		
38.0	14.0	15.8		13.0	14.2		11.3	12.1		9.6	9.7		7.2	7.3	
40.0	12.9	14.7	15.7	11.9	13.2		10.3	11.4		9.4	9.5		7.0	7.1	
42.0	11.5	13.6	14.7	10.8	12.3	13.0	9.3	10.5		9.2	9.4		6.9	6.9	
44.0		12.6	13.7		11.5	12.2		9.7	10.2	8.5	9.2		6.7	6.8	
46.0		11.5	12.8		10.6	11.4		9.0	9.5		8.8			6.6	
48.0		10.4	11.9		9.8	10.7		8.3	8.9		8.3	8.8		6.5	
50.0			11.0			10.0		7.5	8.3		7.6	8.1		6.3	6.3
54.0									7.1			7.0		6.0	6.0
58.0												5.9		6.0	5.8

Tragfähigkeiten
Lifting capacities
Capacités de levage
Capacidades de elevación

138t Light

DIN/ISO/EN

	35.3 m + 2.5 m + 46.0 m			40.4 m + 2.5 m + 46.0 m			45.4 m + 2.5 m + 46.0 m			50.5 m + 2.5 m + 46.0 m			55.6 m + 2.5 m + 46.0 m		
	83°	75°	68°	83°	75°	68°	83°	75°	68°	83°	75°	68°	83°	75°	68°
22.0	17.7														
24.0	17.1														
26.0	16.4			14.2			12.6			9.3					
28.0	15.5			13.9			12.5			9.1			6.8		
30.0	14.5			13.7			12.3			9.0			6.7		
32.0	13.7			13.2			12.1			8.8			6.5		
34.0	12.8	14.9		12.6			11.9			8.7			6.4		
36.0	12.0	14.1		12.0	13.3		11.5			8.6			6.3		
38.0	11.3	13.2		11.3	13.0		11.1	11.9		8.4			6.2		
40.0	10.7	12.4		10.7	12.3		10.6	11.7		8.3	8.4		6.1		
42.0	10.1	11.7	13.3	10.1	11.6		10.2	11.4		8.2	8.2		6.0	5.9	
44.0	9.5	11.0	12.5	9.6	10.8		9.7	10.8		8.1	8.1		5.9	5.8	
46.0	9.0	10.4	11.8	9.1	10.1	10.5	9.1	10.1		7.9	8.0		5.7	5.7	
48.0	8.5	9.8	11.1	8.3	9.4	9.8	8.4	9.4	9.8	7.7	7.8		5.6	5.6	
50.0		9.3	10.5		8.7	9.2		8.8	9.2	7.0	7.7	7.7	5.5	5.5	
54.0			9.3		7.4	8.1		7.6	8.2		6.8	7.1		5.3	5.2
58.0						7.0			7.2		5.6	6.2		5.0	5.0
62.0												5.3			4.8
66.0															4.4

138t

DIN/ISO/EN

	35.3 m + 2.5 m + 46.0 m			40.4 m + 2.5 m + 46.0 m			45.4 m + 2.5 m + 46.0 m			50.5 m + 2.5 m + 46.0 m			55.6 m + 2.5 m + 46.0 m		
	83°	75°	68°	83°	75°	68°	83°	75°	68°	83°	75°	68°	83°	75°	68°
22.0	17.1														
24.0	16.8			14.0											
26.0	16.5			13.8			12.0			9.2					
28.0	16.2			13.7			11.8			9.0			6.6		
30.0	16.0			13.5			11.6			8.9			6.5		
32.0	15.7			13.3			11.5			8.7			6.3		
34.0	15.4	15.4		13.2			11.4			8.6			6.2		
36.0	14.8	15.2		13.0	13.1		11.2			8.5			6.1		
38.0	13.7	14.4		12.2	12.9		11.0	11.2		8.3			6.0		
40.0	12.7	13.5		11.3	12.0		10.6	10.9		8.2	8.2		5.9		
42.0	11.8	12.6	13.0	10.5	11.2		9.7	10.2		8.1	8.1		5.8	5.7	
44.0	10.9	11.8	12.2	9.6	10.4		8.9	9.5		7.9	7.9		5.7	5.6	
46.0	9.9	11.0	11.5	8.8	9.7	10.0	8.2	8.9		7.8	7.8		5.6	5.5	
48.0		10.2	10.7	8.0	9.0	9.4	7.5	8.3	8.5	7.5	7.7		5.5	5.4	
50.0		9.5	10.1		8.4	8.8		7.7	7.9	6.8	7.5	7.5	5.3	5.3	
54.0			8.8		7.1	7.7		6.6	6.9		6.5	6.7		5.0	5.0
58.0						6.6			6.0		5.4	5.8		4.8	4.8
62.0												5.0			4.6
66.0															4.2

**MB
+ LJ + PS**

Tragfähigkeiten
Lifting capacities
Capacités de levage
Capacidades de elevación

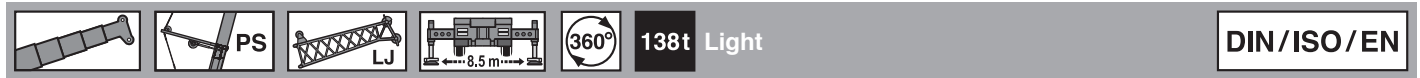

 m	35.3 m + 2.5 m + 52.0 m			40.4 m + 2.5 m + 52.0 m			45.4 m + 2.5 m + 52.0 m			50.5 m + 2.5 m + 52.0 m			55.6 m + 2.5 m + 52.0 m		
	83°	75°	68°	83°	75°	68°	83°	75°	68°	83°	75°	68°	83°	75°	68°
26.0	14.0														
28.0	13.3			12.0			10.2			7.8					
30.0	12.7			11.6			10.1			7.6			5.6		
32.0	12.0			11.1			9.8			7.5			5.5		
34.0	11.4			10.5			9.6			7.4			5.4		
36.0	10.7			10.0			9.2			7.3			5.3		
38.0	10.1	11.7		9.5			8.9			7.2			5.2		
40.0	9.5	11.0		9.0	10.4		8.5	9.4		7.1			5.1		
42.0	9.0	10.4		8.5	9.9		8.2	9.2		7.1	7.0		5.1		
44.0	8.5	9.8		8.0	9.4		7.8	8.8		6.9	7.0		5.0	4.9	
46.0	8.0	9.3	10.5	7.6	8.9		7.4	8.5		6.7	6.9		4.9	4.8	
48.0	7.6	8.7	9.9	7.2	8.4		7.1	8.2		6.5	6.8		4.9	4.8	
50.0	7.2	8.3	9.3	6.8	8.0	8.9	6.8	7.8		6.3	6.7		4.8	4.7	
54.0		7.4	8.3	6.1	7.2	8.1	6.1	7.1	7.3	5.8	6.5	6.5	4.6	4.5	
58.0		6.7	7.5		6.4	7.2		6.2	6.4		6.0	6.2		4.4	4.3
62.0			6.7			6.3		5.2	5.6		5.2	5.5		4.2	4.1
66.0									4.9			4.7		4.0	4.0
70.0														3.8	3.8

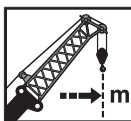

 m	35.3 m + 2.5 m + 52.0 m			40.4 m + 2.5 m + 52.0 m			45.4 m + 2.5 m + 52.0 m			50.5 m + 2.5 m + 52.0 m			55.6 m + 2.5 m + 52.0 m		
	83°	75°	68°	83°	75°	68°	83°	75°	68°	83°	75°	68°	83°	75°	68°
24.0	15.5														
26.0	15.3														
28.0	15.1			12.9			10.5			7.8					
30.0	14.9			12.7			10.3			7.7			5.4		
32.0	14.8			12.6			10.2			7.5			5.4		
34.0	14.6			12.4			10.1			7.4			5.3		
36.0	14.5	14.5		12.3			10.0			7.3			5.2		
38.0	14.4	14.4		12.0			9.9			7.2			5.1		
40.0	14.1	14.2		11.7	11.8		9.7	9.8		7.1			5.0		
42.0	13.2	13.6		10.9	11.3		9.6	9.7		7.0	7.0		4.9		
44.0	12.3	13.1		10.1	10.6		9.4	9.4		7.0	6.9		4.9	4.8	
46.0	11.5	12.3	11.1	9.4	9.9		8.7	9.0		6.9	6.8		4.8	4.7	
48.0	10.6	11.6	10.6	8.7	9.3		8.1	8.4		6.8	6.7		4.7	4.6	
50.0	9.8	10.8	10.2	8.1	8.7	8.5	7.4	7.9		6.7	6.6		4.7	4.5	
54.0		9.5	9.4	6.7	7.6	7.8	6.2	6.8	7.0	6.3	6.4	6.4	4.5	4.4	
58.0		8.1	8.8		6.5	6.9		5.9	6.1		5.8	5.9		4.2	4.1
62.0			7.7			6.0		5.0	5.3		4.9	5.1		4.0	3.9
66.0									4.6			4.4			3.8
70.0															3.6

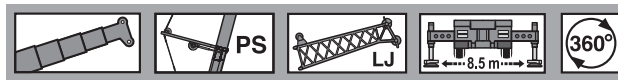

138t Light **DIN/ISO/EN**

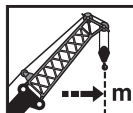
 m	35.3 m + 2.5 m + 58.0 m			40.4 m + 2.5 m + 58.0 m			45.4 m + 2.5 m + 58.0 m			50.5 m + 2.5 m + 58.0 m			55.6 m + 2.5 m + 58.0 m		
	83°	75°	68°	83°	75°	68°	83°	75°	68°	83°	75°	68°	83°	75°	68°
26.0	14.1														
28.0	13.9			11.3											
30.0	13.8			11.2			8.8								
32.0	13.6			11.1			8.7			6.4			4.4		
34.0	13.4			11.0			8.6			6.3			4.3		
36.0	13.1			10.8			8.5			6.2			4.2		
38.0	12.7	13.3		10.7			8.5			6.1			4.1		
40.0	12.2	13.0		10.6			8.4			6.1			4.1		
42.0	11.8	12.6		10.5	10.5		8.3			6.0			4.0		
44.0	11.4	12.1		10.3	10.4		8.2	8.2		5.9			4.0		
46.0	10.9	11.4		9.7	10.0		8.1	8.1		5.8	5.8		3.9		
48.0	10.3	10.7		9.0	9.3		8.1	8.0		5.8	5.7		3.9	3.7	
50.0	9.6	10.1	9.9	8.4	8.7		7.7	7.9		5.7	5.7		3.8	3.7	
54.0	8.4	8.9	9.1	7.3	7.7	7.7	6.7	6.9		5.6	5.5		3.7	3.6	
58.0	7.1	7.8	8.1	6.2	6.7	6.8	5.7	6.0	6.0	5.5	5.4	5.3	3.7	3.5	
62.0		6.8	7.1		5.8	6.0		5.2	5.3		5.1	4.8	3.5	3.4	3.2
66.0			6.3		4.9	5.3		4.5	4.6		4.4	4.3		3.3	3.2
70.0						4.6			4.0			3.7		3.2	3.0
74.0												3.1			2.5

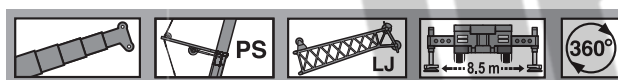



138t **DIN/ISO/EN**

 m	35.3 m + 2.5 m + 58.0 m			40.4 m + 2.5 m + 58.0 m			45.4 m + 2.5 m + 58.0 m			50.5 m + 2.5 m + 58.0 m			55.6 m + 2.5 m + 58.0 m		
	83°	75°	68°	83°	75°	68°	83°	75°	68°	83°	75°	68°	83°	75°	68°
26.0	14.1														
28.0	13.9			11.2											
30.0	13.8			11.1			8.7								
32.0	13.6			11.0			8.6			6.1			4.1		
34.0	13.4			10.8			8.5			6.0			4.0		
36.0	13.3			10.7			8.3			6.0			3.9		
38.0	13.2	13.2		10.6			8.3			5.9			3.8		
40.0	12.8	12.8		10.5			8.2			5.8			3.8		
42.0	12.1	12.3		10.2	10.3		8.1			5.7			3.7		
44.0	11.4	11.7		10.0	10.1		8.0	8.0		5.7			3.7		
46.0	10.7	11.0		9.3	9.5		7.9	7.9		5.6	5.5		3.6		
48.0	10.0	10.3	9.9	8.7	8.9		7.8	7.7		5.5	5.5		3.6	3.5	
50.0	9.3	9.7	9.4	8.1	8.3		7.4	7.6		5.5	5.4		3.6	3.4	
54.0	8.0	8.5	8.6	7.0	7.3	7.3	6.3	6.5		5.4	5.2		3.4	3.3	
58.0	6.8	7.5	7.7	5.9	6.4	6.5	5.4	5.7	5.6	5.2	5.1	4.8	3.4	3.2	
62.0		6.4	6.8		5.5	5.7		4.9	4.9		4.8	4.3	3.3	3.1	3.0
66.0			5.9		4.6	5.0		4.1	4.3		4.0	3.6		3.0	2.9
70.0						4.2			3.7			3.0		2.9	2.3
74.0												2.4			1.8

MB
+ LJ+PS

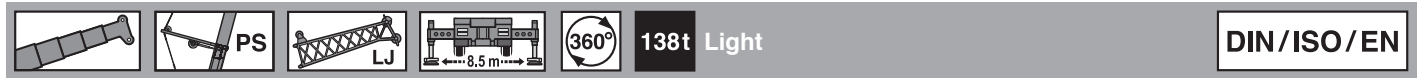
Tragfähigkeiten
Lifting capacities
Capacités de levage
Capacidades de elevación





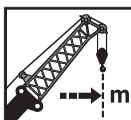

	35.3 m + 2.5 m + 64.0 m			40.4 m + 2.5 m + 64.0 m			45.4 m + 2.5 m + 64.0 m			50.5 m + 2.5 m + 64.0 m			55.6 m + 2.5 m + 64.0 m		
	83°	75°	68°	83°	75°	68°	83°	75°	68°	83°	75°	68°	83°	75°	68°
28.0	12.3														
30.0	12.1			9.5											
32.0	11.7			9.5			7.4								
34.0	11.4			9.4			7.3			5.1			3.4		
36.0	11.0			9.3			7.3			5.0			3.3		
38.0	10.6			9.2			7.2			5.0			3.3		
40.0	10.2			9.0			7.1			5.0			3.2		
42.0	9.8	10.8		8.8			7.1			5.0			3.2		
44.0	9.4	10.4		8.6	9.0		7.0			4.9			3.2		
46.0	9.0	10.0		8.3	8.8		6.9	6.9		4.8			3.1		
48.0	8.6	9.6		8.1	8.7		6.9	6.8		4.8	4.7		3.1		
50.0	8.3	9.2		7.8	8.4		6.8	6.8		4.7	4.7		3.1	2.9	
54.0	7.6	8.5	7.9	7.3	7.7		6.6	6.7		4.7	4.6		2.9	2.8	
58.0	7.0	7.8	7.3	6.6	6.8	6.1	6.0	6.1		4.6	4.5		2.9	2.7	
62.0	6.4	7.1	6.7	5.6	6.0	5.6	5.1	5.3	4.6	4.6	4.4	3.9	2.9	2.7	
66.0		6.6	6.2	4.7	5.2	5.1	4.2	4.6	4.1	4.3	4.3	3.4	2.8	2.6	2.4
70.0		6.1	5.4		4.5	4.4		4.0	3.5		3.8	2.9		2.6	2.3
74.0			4.8			3.8		3.3	2.9		3.2	2.3		2.5	1.8
78.0									2.4			1.9			

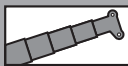

	35.3 m + 2.5 m + 64.0 m			40.4 m + 2.5 m + 64.0 m			45.4 m + 2.5 m + 64.0 m			50.5 m + 2.5 m + 64.0 m			55.6 m + 2.5 m + 64.0 m		
	83°	75°	68°	83°	75°	68°	83°	75°	68°	83°	75°	68°	83°	75°	68°
28.0	12.3														
30.0	12.1			9.6											
32.0	12.0			9.5			7.4			5.1					
34.0	11.9			9.4			7.3			5.0			3.1		
36.0	11.7			9.3			7.2			5.0			3.1		
38.0	11.6			9.2			7.1			4.9			3.0		
40.0	11.5			9.1			7.0			4.8			3.0		
42.0	11.4	11.5		9.0			7.0			4.8			2.9		
44.0	11.3	11.0		8.9	8.9		6.9			4.7			2.9		
46.0	11.2	10.5		8.8	8.9		6.8	6.8		4.7			2.9		
48.0	11.0	10.1		8.7	8.6		6.8	6.7		4.6	4.5		2.8		
50.0	10.3	9.7		8.3	8.2		6.7	6.7		4.6	4.5		2.8	2.6	
54.0	9.1	8.9	7.5	7.2	7.4		6.4	6.5		4.5	4.4		2.7	2.5	
58.0	7.9	8.3	6.9	6.3	6.5	5.5	5.7	5.7		4.4	4.3		2.6	2.5	
62.0	6.8	7.5	6.3	5.3	5.7	5.0	4.8	5.0	4.0	4.4	4.2	3.5	2.6	2.4	
66.0		6.5	5.6		4.9	4.4	4.0	4.3	3.4	4.0	4.1	2.9	2.6	2.3	2.1
70.0		5.6	4.9		4.2	3.8		3.6	2.8		3.5	2.3		2.3	1.6
74.0			4.2			3.2		3.0	2.3		2.9	1.8		2.3	
78.0									1.8						

					138t	DIN/ISO/EN
--	---	---	---	---	-------------	-------------------

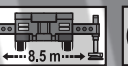
	35.3 m + 2.5 m + 70.0 m			40.4 m + 2.5 m + 70.0 m			45.4 m + 2.5 m + 70.0 m			50.5 m + 2.5 m + 70.0 m					
	83°	75°	68°	83°	75°	68°	83°	75°	68°	83°	75°	68°			
32.0	10.3														
34.0	10.2			8.0			6.1								
36.0	10.1			8.0			6.0			3.9					
38.0	10.0			7.9			5.9			3.8					
40.0	9.9			7.8			5.8			3.8					
42.0	9.8			7.8			5.8			3.8					
44.0	9.7			7.7			5.8			3.8					
46.0	9.7	9.1		7.6			5.7			3.8					
48.0	9.6	8.7		7.6	7.4		5.6			3.7					
50.0	9.5	8.4		7.5	7.1		5.6	5.6		3.7					
54.0	9.1	7.7		7.1	6.5		5.5	5.5		3.6	3.5				
58.0	8.2	7.1	5.8	6.4	6.0		5.4	5.4		3.6	3.4				
62.0	7.1	6.6	5.3	5.5	5.5	4.1	5.0	4.9	3.5	3.5	3.3				
66.0	6.2	6.2	4.9	4.7	4.9	3.7	4.2	4.2	3.0	3.5	3.3	2.1			
70.0	5.2	5.7	4.2	4.0	4.3	3.1	3.5	3.6	2.4	3.4	3.3	1.6			
74.0		5.1	3.6		3.6	2.5		3.1	1.9		3.0				
78.0			3.0		3.0	2.0		2.6			2.4				
82.0						1.5									

					138t	DIN/ISO/EN
--	---	---	---	---	-------------	-------------------

	35.3 m + 2.5 m + 76.0 m			40.4 m + 2.5 m + 76.0 m			45.4 m + 2.5 m + 76.0 m								
	83°	75°	68°	83°	75°	68°	83°	75°	68°						
34.0	8.6														
36.0	8.6			6.6			4.8								
38.0	8.5			6.5			4.8								
40.0	8.4			6.5			4.8								
42.0	8.3			6.4			4.7								
44.0	8.3			6.4			4.7								
46.0	8.2			6.3			4.6								
48.0	8.1	7.1		6.3			4.6								
50.0	8.0	6.8		6.3	5.9		4.6								
54.0	7.7	6.3		6.2	5.4		4.5	4.4							
58.0	7.3	5.8		6.0	4.9		4.4	4.4							
62.0	6.9	5.3	4.0	5.4	4.5		4.3	4.1							
66.0	6.2	4.9	3.7	4.7	4.1	2.7	4.1	3.7	2.1						
70.0	5.4	4.6	3.2	4.0	3.8	2.2	3.5	3.4	1.5						
74.0	4.6	4.2	2.6	3.4	3.5	1.7	3.0	3.0							
78.0		3.7	2.0		3.0		2.4	2.5							
82.0		3.1	1.6		2.4			2.0							

MB
+ LJ + PS

HTLJ / Hubhöhen
 HTLJ / Lifting heights
 HTLJ / Hauteurs de levage
 HTLJ / Alturas de elevación

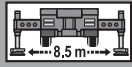
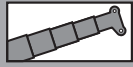

118t

DIN/ISO/EN

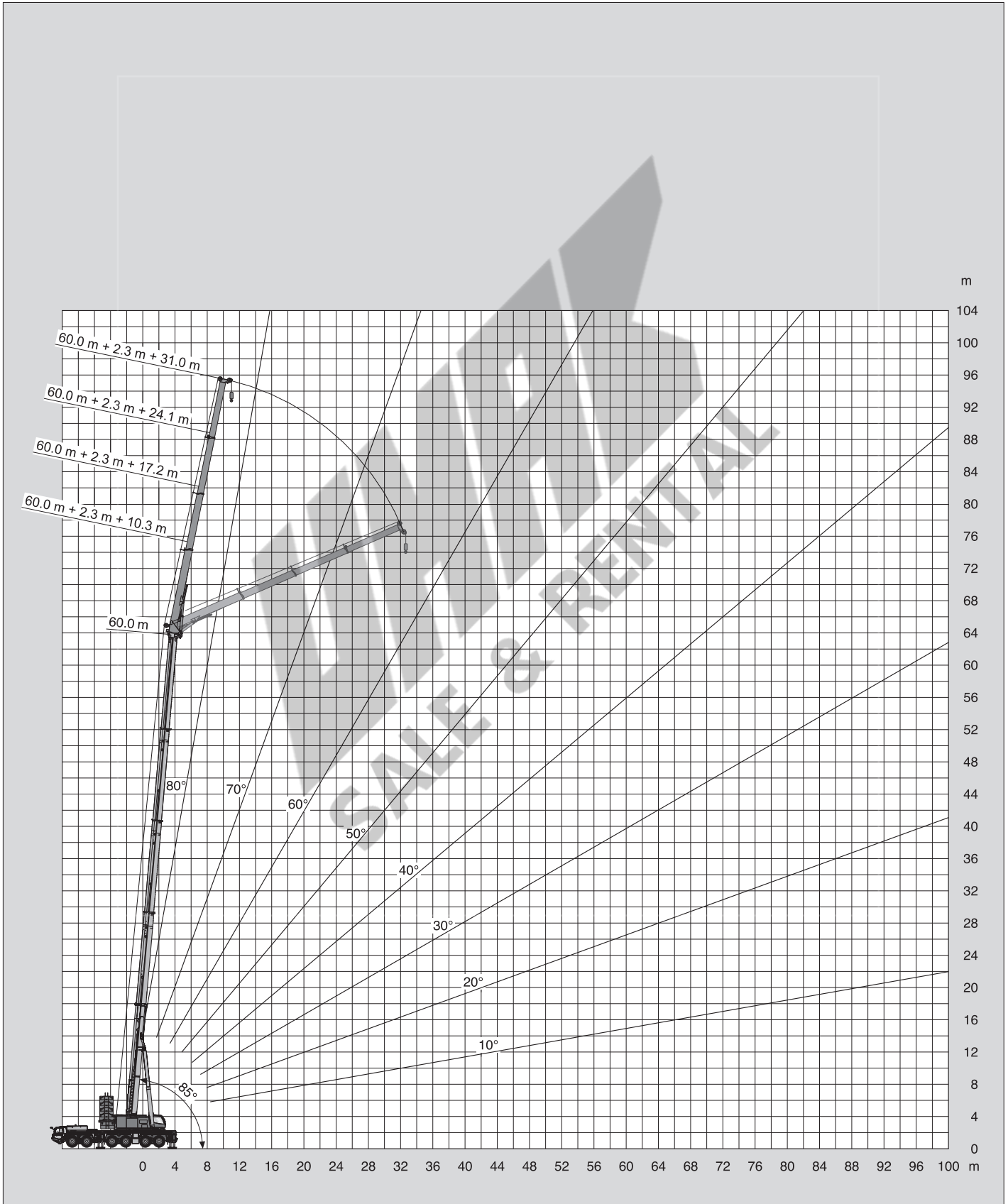

HTLJ / Tragfähigkeiten
HTLJ / Lifting capacities
HTLJ / Capacités de levage
HTLJ / Capacidades de elevación

360° **118t** **DIN/ISO/EN**

m	40.4 m + 2.3 m + 10.3 m					40.4 m + 2.3 m + 17.2 m					40.4 m + 2.3 m + 24.1 m					40.4 m + 2.3 m + 31.0 m				
	5°	15°	30°	45°	60°	5°	15°	30°	45°	60°	5°	15°	30°	45°	60°	5°	15°	30°	45°	60°
9.0	38.4																			
10.0	36.0					16.7														
11.0	33.8	31.6				16.7														
12.0	31.9	30.2				16.7														
14.0	28.6	27.3	25.2			16.7	16.7				16.0									
16.0	25.8	24.8	23.5	22.1	21.1	16.7	16.7				15.5					10.9				
18.0	23.5	22.6	21.6	20.9	20.3	16.7	16.7	16.7			15.0	13.5				10.8				
20.0	21.5	20.8	19.9	19.4	19.0	16.7	16.7	15.9			14.5	13.0				10.5				
22.0	19.8	19.2	18.5	18.0	17.7	16.7	16.7	15.2	14.0		13.9	12.5				10.3	9.2			
24.0	18.3	17.8	17.2	16.8	16.5	16.7	16.2	14.5	13.4	12.9	13.4	12.1	10.8			10.0	8.8			
26.0	17.0	16.5	16.0	15.7	15.5	15.9	15.4	13.9	13.0	12.5	12.9	11.7	10.5			9.7	8.4			
28.0	15.8	15.4	15.0	14.7	14.6	14.8	14.4	13.3	12.5	12.1	12.5	11.4	10.1	9.3		9.2	8.1			
30.0	13.9	14.2	14.0	13.8		13.9	13.5	12.8	12.1	11.8	12.1	11.1	9.8	9.0	8.5	8.8	7.8	6.7		
32.0	12.1	12.4	12.7	12.9		13.0	12.6	12.2	11.8	11.6	11.7	10.8	9.5	8.8	8.4	8.5	7.5	6.4		
34.0	10.5	10.8	11.1	11.2		11.9	11.9	11.5	11.3	11.2	11.3	10.4	9.3	8.6	8.3	8.1	7.2	6.2		
36.0	9.1	9.4	9.6	9.7		10.5	10.9	10.9	10.7	10.6	10.9	10.0	9.0	8.5	8.2	7.8	6.9	6.1	5.5	
38.0	7.9	8.1	8.3	8.3		9.3	9.7	10.1	10.1		10.2	9.6	8.8	8.3	8.1	7.5	6.7	5.9	5.3	
40.0	6.7	6.9	7.1			8.2	8.5	9.0	9.2		9.1	9.3	8.5	8.1	8.0	7.2	6.5	5.7	5.2	5.0
42.0	5.7	5.9	6.0			7.1	7.5	7.9	8.1		8.1	8.5	8.2	7.9		7.0	6.3	5.5	5.1	5.0
44.0	4.8	4.9	5.0			6.2	6.5	6.9	7.0		7.2	7.6	8.0	7.7		6.7	6.1	5.4	5.0	4.9
46.0	3.9	4.0				5.3	5.6	5.9			6.3	6.8	7.3	7.4		6.5	5.9	5.3	4.9	4.8
48.0	3.1	3.2				4.6	4.8	5.0			5.6	6.0	6.5	6.7		6.3	5.7	5.1	4.8	
50.0						3.8	4.0	4.2			4.9	5.2	5.7	5.9		5.9	5.5	5.0	4.7	
54.0						2.5	2.7				3.6	3.9	4.2			4.6	5.0	4.8	4.6	
58.0											2.5	2.7	2.9			3.5	3.9	4.3		
62.0											1.5	1.6				2.5	2.8	3.1		
66.0																1.7	1.9			

360° **118t** **DIN/ISO/EN**

m	45.4 m + 2.3 m + 10.3 m					45.4 m + 2.3 m + 17.2 m					45.4 m + 2.3 m + 24.1 m					45.4 m + 2.3 m + 31.0 m				
	5°	15°	30°	45°	60°	5°	15°	30°	45°	60°	5°	15°	30°	45°	60°	5°	15°	30°	45°	60°
10.0	29.3																			
11.0	27.6																			
12.0	26.1	24.4				16.7														
14.0	23.5	22.1	20.5			16.7					14.5									
16.0	21.3	20.2	18.8	17.9		16.7	16.7				14.5					10.2				
18.0	19.5	18.5	17.4	16.6	15.4	16.7	16.7				14.1					10.0				
20.0	17.9	17.1	16.1	15.5	15.1	16.4	15.4	14.3			13.7	12.5				9.8				
22.0	16.5	15.8	15.0	14.4	14.1	15.2	14.3	13.3			13.4	12.1				9.6	8.8			
24.0	15.3	14.7	14.0	13.5	13.2	14.1	13.3	12.5	11.9		13.0	11.7				9.4	8.4			
26.0	14.2	13.7	13.1	12.7	12.5	13.1	12.4	11.7	11.2	10.1	12.1	11.4	10.1			9.2	8.1			
28.0	13.3	12.8	12.3	12.0	11.8	12.2	11.6	11.0	10.5	9.9	11.3	10.7	9.8			8.9	7.8			
30.0	12.1	12.0	11.6	11.3	11.2	11.4	10.9	10.3	9.9	9.7	10.6	10.0	9.4	8.8		8.6	7.5	6.5		
32.0	10.8	10.8	10.7	10.6		10.7	10.2	9.7	9.4	9.2	9.9	9.4	8.9	8.5	7.3	8.2	7.3	6.3		
34.0	9.7	9.7	9.6	9.6		10.0	9.6	9.2	8.9	8.7	9.3	8.9	8.4	8.1	7.2	7.9	7.0	6.1		
36.0	8.3	8.6	8.7	8.6		9.1	9.1	8.7	8.4	8.3	8.8	8.4	7.9	7.7	7.1	7.6	6.8	5.9	5.4	
38.0	7.1	7.3	7.6	7.7		8.2	8.2	8.0	7.8	7.7	8.2	7.9	7.5	7.2	7.0	7.4	6.6	5.7	5.3	
40.0	5.9	6.2	6.4	6.5		7.4	7.4	7.4	7.3		7.5	7.2	6.9	6.7	6.5	7.1	6.4	5.6	5.1	4.9
42.0	4.9	5.2	5.4			6.4	6.7	6.8	6.7		6.9	6.7	6.4	6.2	6.1	6.9	6.2	5.4	5.0	4.9
44.0	4.0	4.2	4.4			5.5	5.8	6.1	6.1		6.2	6.2	5.9	5.8		6.3	6.0	5.3	4.9	4.8
46.0	3.2	3.3	3.5			4.6	5.0	5.4	5.5		5.6	5.7	5.5	5.3		5.8	5.7	5.2	4.8	4.7
48.0	2.4	2.5	2.6			3.8	4.2	4.5	4.6		4.9	5.2	5.1	4.9		5.4	5.2	5.0	4.7	4.7
50.0	1.7	1.8				3.1	3.4	3.7			4.2	4.6	4.7	4.6		5.0	4.8	4.7	4.5	
54.0						1.9	2.1	2.2			2.9	3.3	3.7			3.9	4.1	4.0	3.9	
58.0											1.8	2.1	2.4			2.8	3.3	3.3	3.3	

MB+HTLJ

HTLJ / Tragfähigkeiten
 HTLJ / Lifting capacities
 HTLJ / Capacités de levage
 HTLJ / Capacidades de elevación



m	50.5 m + 2.3 m + 10.3 m					50.4 m + 2.3 m + 17.2 m					50.4 m + 2.3 m + 24.1 m					50.4 m + 2.3 m + 31.0 m				
	5°	15°	30°	45°	60°	5°	15°	30°	45°	60°	5°	15°	30°	45°	60°	5°	15°	30°	45°	60°
11.0	21.2																			
12.0	20.0																			
14.0	17.8	16.8				16.5														
16.0	16.0	15.2	14.2			15.0					13.0									
18.0	14.5	13.9	13.1	12.4	11.0	13.6	12.5				12.4					9.3				
20.0	13.2	12.7	12.1	11.6	10.7	12.4	11.7				11.5					9.3				
22.0	12.1	11.6	11.1	10.7	10.5	11.4	10.8	9.8			10.7	9.6				9.2				
24.0	11.1	10.7	10.3	9.9	9.7	10.5	10.0	9.2	8.5		9.9	9.0				9.0	8.3			
26.0	10.2	9.9	9.5	9.2	9.1	9.7	9.3	8.7	8.1	7.7	9.1	8.5	7.5			8.7	7.8			
28.0	9.3	9.0	8.7	8.5	8.3	8.9	8.6	8.2	7.7	7.4	8.4	8.0	7.1			8.2	7.4			
30.0	8.3	8.1	7.8	7.6	7.5	8.2	7.9	7.6	7.4	7.1	7.8	7.5	6.8			7.7	7.0			
32.0	7.4	7.2	7.0	6.9	6.7	7.3	7.1	6.9	6.7	6.6	7.1	6.9	6.4	6.0		7.2	6.6	5.9		
34.0	6.6	6.4	6.3	6.1		6.5	6.4	6.2	6.1	6.0	6.4	6.2	6.1	5.7	5.4	6.6	6.3	5.6		
36.0	5.8	5.7	5.6	5.5		5.9	5.7	5.6	5.5	5.4	5.7	5.6	5.5	5.4	5.2	5.9	5.8	5.3		
38.0	5.1	5.1	4.9	4.9		5.2	5.1	5.0	4.9	4.9	5.1	5.0	5.0	4.9	4.8	5.3	5.3	5.1	4.7	
40.0	4.5	4.5	4.4	4.3		4.6	4.6	4.5	4.4	4.4	4.6	4.5	4.5	4.4	4.4	4.8	4.8	4.7	4.5	
42.0	4.0	3.9	3.8	3.8		4.1	4.1	4.0	4.0		4.1	4.0	4.0	4.0	3.9	4.3	4.3	4.3	4.2	4.0
44.0	3.5	3.4	3.4	3.3		3.6	3.6	3.6	3.5		3.6	3.6	3.6	3.6	3.5	3.9	3.9	3.9	3.9	3.7
46.0	2.8	2.9	2.9			3.2	3.1	3.1	3.1		3.2	3.2	3.2	3.2		3.4	3.5	3.5	3.5	3.5
48.0	2.0	2.2	2.4			2.7	2.7	2.7	2.7		2.8	2.8	2.8	2.8		3.0	3.1	3.1	3.1	3.1
50.0		1.5	1.6			2.4	2.4	2.4	2.3		2.4	2.4	2.5	2.5		2.7	2.7	2.8	2.8	2.8
54.0						1.5	1.7	1.7			1.7	1.8	1.8	1.8		2.0	2.1	2.2	2.2	
58.0																1.5	1.6	1.6		



m	55.6 m + 2.3 m + 10.3 m					55.6 m + 2.3 m + 17.2 m					55.6 m + 2.3 m + 24.1 m					55.6 m + 2.3 m + 31.0 m				
	5°	15°	30°	45°	60°	5°	15°	30°	45°	60°	5°	15°	30°	45°	60°	5°	15°	30°	45°	60°
12.0	16.1																			
14.0	15.6	14.5																		
16.0	13.9	13.2				12.7														
18.0	12.5	12.1	11.2			11.6	10.7				10.3									
20.0	11.3	11.0	10.4	9.9	8.5	10.7	9.8				10.1					6.9				
22.0	10.3	10.0	9.6	9.2	8.2	9.8	9.1	8.3			9.3	8.5				6.9				
24.0	9.3	9.1	8.8	8.6	8.0	8.9	8.5	7.8			8.6	7.9				6.9				
26.0	8.1	8.0	7.8	7.7	7.5	8.0	7.9	7.3	6.9		8.0	7.4				6.9	6.9			
28.0	7.0	6.9	6.8	6.7	6.6	7.0	6.9	6.8	6.5	6.2	7.3	6.9	6.3			6.9	6.4			
30.0	6.1	6.0	6.0	5.9	5.8	6.1	6.1	6.1	6.0	5.9	6.5	6.5	5.9			6.5	6.0			
32.0	5.2	5.2	5.2	5.1	5.0	5.3	5.3	5.3	5.3	5.3	5.7	5.7	5.6			5.8	5.6			
34.0	4.5	4.5	4.4	4.4	4.3	4.6	4.6	4.7	4.7	4.6	5.0	5.1	5.1	4.9		5.1	5.2	4.9		
36.0	3.8	3.8	3.8	3.7	3.7	3.9	4.0	4.1	4.1	4.0	4.4	4.5	4.6	4.5	4.3	4.5	4.6	4.5		
38.0	3.1	3.1	3.2	3.1		3.3	3.4	3.5	3.5	3.5	3.8	3.9	4.0	4.1	4.0	3.9	4.1	4.1		
40.0	2.5	2.6	2.6	2.6		2.8	2.9	3.0	3.0	3.0	3.2	3.4	3.5	3.6	3.6	3.4	3.6	3.7	3.5	
42.0	2.0	2.0	2.1	2.0		2.3	2.4	2.5	2.5	2.5	2.7	2.9	3.0	3.1	3.1	3.0	3.1	3.3	3.2	
44.0	1.5	1.5	1.6	1.6		1.8	1.9	2.0	2.1		2.3	2.4	2.6	2.7	2.7	2.5	2.7	2.9	2.9	2.8
46.0							1.5	1.6	1.6		1.9	2.0	2.2	2.3	2.3	2.1	2.3	2.5	2.6	2.6
48.0											1.5	1.6	1.8	1.9		1.7	1.9	2.1	2.3	2.3
50.0														1.5				1.9	2.0	2.0

HTLJ / Tragfähigkeiten
 HTLJ / Lifting capacities
 HTLJ / Capacités de levage
 HTLJ / Capacidades de elevación

118t

DIN/ISO/EN

	60.0 m + 2.3 m + 10.3 m					60.0 m + 2.3 m + 17.2 m					60.0 m + 2.3 m + 24.1 m					60.0 m + 2.3 m + 31.0 m				
	5°	15°	30°	45°	60°	5°	15°	30°	45°	60°	5°	15°	30°	45°	60°	5°	15°	30°	45°	60°
14.0	13.2																			
16.0	12.8	12.3				8.8														
18.0	11.5	11.2	10.5			8.8					7.8									
20.0	10.4	10.1	9.7	9.2		8.8	8.8				7.8					6.2				
22.0	9.4	9.2	8.9	8.6	8.3	8.8	8.8				7.8					6.2				
24.0	8.2	8.1	8.0	7.9	7.7	8.5	8.2	7.5			7.8	7.4				6.2				
26.0	7.1	7.0	7.0	6.9	6.7	7.5	7.5	7.0			7.5	6.9				6.2				
28.0	6.1	6.1	6.0	6.0	5.9	6.5	6.5	6.5	6.2		6.6	6.5				6.2				
30.0	5.2	5.2	5.2	5.1	5.1	5.6	5.7	5.7	5.7	5.7	5.8	5.9	5.3			5.8	5.4			
32.0	4.4	4.4	4.4	4.4	4.3	4.9	4.9	5.0	5.0	5.0	5.0	5.1	4.9			5.1	4.9			
34.0	3.6	3.7	3.7	3.7	3.6	4.1	4.2	4.3	4.4	4.3	4.4	4.5	4.5	4.2		4.4	4.4			
36.0	3.0	3.0	3.1	3.1	3.0	3.5	3.6	3.7	3.8	3.7	3.7	3.9	4.1	3.9		3.8	4.0	3.6		
38.0	2.3	2.4	2.5	2.5		2.9	3.0	3.2	3.2	3.2	3.2	3.3	3.5	3.5	3.5	3.3	3.5	3.3		
40.0	1.8	1.8	1.9	1.9		2.3	2.5	2.6	2.7	2.7	2.6	2.8	3.0	3.2	3.2	2.8	3.0	3.0		
42.0						1.8	2.0	2.1	2.2	2.2	2.1	2.3	2.6	2.7	2.7	2.3	2.6	2.7	2.6	
44.0							1.5	1.7	1.8		1.7	1.9	2.1	2.3	2.3	1.9	2.2	2.5	2.4	
46.0												1.5	1.7	1.9	1.9	1.5	1.8	2.1	2.2	2.2
48.0													1.5	1.5			1.7	1.9	2.0	2.0
50.0																		1.6	1.6	1.6

58t

DIN/ISO/EN

	40.4 m + 2.3 m + 10.3 m					40.4 m + 2.3 m + 17.2 m					40.4 m + 2.3 m + 24.1 m					40.4 m + 2.3 m + 31.0 m				
	5°	15°	30°	45°	60°	5°	15°	30°	45°	60°	5°	15°	30°	45°	60°	5°	15°	30°	45°	60°
9.0	38.4																			
10.0	36.0					16.7														
11.0	33.8	31.6				16.7														
12.0	31.9	30.2				16.7														
14.0	28.6	27.3	25.2			16.7	16.7				16.0									
16.0	25.8	24.8	23.5	22.1	21.1	16.7	16.7				15.5					10.9				
18.0	23.5	22.6	21.6	20.9	20.3	16.7	16.7	16.7			15.0	13.5				10.8				
20.0	20.5	20.8	19.9	19.4	19.0	16.7	16.7	15.9			14.5	13.0				10.5				
22.0	16.8	17.9	18.5	18.0	17.7	16.7	16.7	15.2	14.0		13.9	12.5				10.3	9.2			
24.0	13.8	14.7	15.9	16.8	16.5	15.7	16.2	14.5	13.4	12.9	13.4	12.1	10.8			10.0	8.8			
26.0	11.3	12.1	13.1	13.8	14.2	13.2	14.5	13.9	13.0	12.5	12.9	11.7	10.5			9.7	8.4			
28.0	9.1	9.8	10.7	11.3	11.5	11.0	12.2	13.3	12.5	12.1	12.4	11.4	10.1	9.3		9.2	8.1			
30.0	7.2	7.9	8.6	9.1		9.2	10.2	11.7	12.1	11.8	10.6	11.1	9.8	9.0	8.5	8.8	7.8	6.7		
32.0	5.5	6.1	6.7	7.0		7.5	8.5	9.8	10.8	11.4	9.0	10.3	9.5	8.8	8.4	8.5	7.5	6.4		
34.0	4.0	4.5	5.0	5.2		6.1	7.0	8.1	9.0	9.4	7.5	8.8	9.3	8.6	8.3	8.1	7.2	6.2		
36.0	2.6	3.1	3.5	3.7		4.8	5.6	6.6	7.3	7.5	6.3	7.4	8.9	8.5	8.2	7.6	6.9	6.1	5.5	
38.0			2.2	2.3		3.6	4.3	5.2	5.8		5.1	6.2	7.5	8.3	8.1	6.4	6.7	5.9	5.3	
40.0						2.6	3.2	3.9	4.4		4.1	5.0	6.3	7.2	7.7	5.4	6.5	5.7	5.2	5.0
42.0							2.2	2.8	3.1		3.1	4.0	5.1	5.9		4.5	5.6	5.5	5.1	5.0
44.0											2.3	3.0	4.0	4.7		3.6	4.7	5.4	5.0	4.9
46.0												2.2	3.0	3.6		2.9	3.8	5.1	4.9	4.8
48.0													2.1	2.6			3.0	4.2	4.8	
50.0																	2.3	3.3	4.1	
54.0																			2.4	

MB+HTLJ

HTLJ / Tragfähigkeiten
 HTLJ / Lifting capacities
 HTLJ / Capacités de levage
 HTLJ / Capacidades de elevación







m	45.4 m + 2.3 m + 10.3 m					45.4 m + 2.3 m + 17.2 m					45.4 m + 2.3 m + 24.1 m					45.4 m + 2.3 m + 31.0 m				
	5°	15°	30°	45°	60°	5°	15°	30°	45°	60°	5°	15°	30°	45°	60°	5°	15°	30°	45°	60°
10.0	29.3																			
11.0	27.6																			
12.0	26.1	24.4				16.7														
14.0	23.5	22.1	20.5			16.7					14.5									
16.0	21.3	20.2	18.8	17.9		16.7	16.7				14.5					10.2				
18.0	19.5	18.5	17.4	16.6	15.4	16.7	16.7				14.1					10.0				
20.0	17.9	17.1	16.1	15.5	15.1	16.4	15.4	14.3			13.7	12.5				9.8				
22.0	16.3	15.8	15.0	14.4	14.1	15.2	14.3	13.3			13.4	12.1				9.6	8.8			
24.0	13.4	14.3	14.0	13.5	13.2	14.1	13.3	12.5	11.9		13.0	11.7				9.4	8.4			
26.0	10.9	11.7	12.8	12.7	12.5	12.7	12.4	11.7	11.2	10.1	12.1	11.4	10.1			9.2	8.1			
28.0	8.8	9.5	10.5	11.1	11.4	10.6	11.6	11.0	10.5	9.9	11.3	10.7	9.8			8.9	7.8			
30.0	7.0	7.6	8.4	9.0	9.2	8.8	9.9	10.3	9.9	9.7	10.1	10.0	9.4	8.8		8.6	7.5	6.5		
32.0	5.4	6.0	6.7	7.1		7.2	8.2	9.5	9.4	9.2	8.5	9.4	8.9	8.5	7.3	8.2	7.3	6.3		
34.0	4.0	4.5	5.1	5.5		5.8	6.7	7.9	8.8	8.7	7.1	8.4	8.4	8.1	7.2	7.9	7.0	6.1		
36.0		3.2	3.7	3.9		4.5	5.3	6.4	7.2	7.6	5.9	7.0	7.9	7.7	7.1	7.1	6.8	5.9	5.4	
38.0						3.4	4.1	5.1	5.8	6.0	4.8	5.8	7.3	7.2	7.0	6.0	6.6	5.7	5.3	
40.0							3.1	3.9	4.5		3.8	4.7	6.0	6.7	6.5	5.0	6.2	5.6	5.1	4.9
42.0								2.8	3.3		2.8	3.7	4.9	5.9	6.1	4.1	5.2	5.4	5.0	4.9
44.0												2.8	3.9	4.7		3.2	4.3	5.3	4.9	4.8
46.0													3.0	3.7			3.5	4.8	4.8	4.7
48.0														2.7			2.7	4.0	4.7	4.7
50.0																		3.2	4.1	

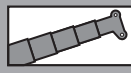

m	50.5 m + 2.3 m + 10.3 m					50.4 m + 2.3 m + 17.2 m					50.4 m + 2.3 m + 24.1 m					50.4 m + 2.3 m + 31.0 m				
	5°	15°	30°	45°	60°	5°	15°	30°	45°	60°	5°	15°	30°	45°	60°	5°	15°	30°	45°	60°
11.0	21.2																			
12.0	20.0																			
14.0	17.8	16.8				16.5														
16.0	16.0	15.2	14.2			15.0					13.0									
18.0	14.5	13.9	13.1	12.4	11.0	13.6	12.5				12.4					9.3				
20.0	13.2	12.7	12.1	11.6	10.7	12.4	11.7				11.5					9.3				
22.0	12.1	11.6	11.1	10.7	10.5	11.4	10.8	9.8			10.7	9.6				9.2				
24.0	11.1	10.7	10.3	9.9	9.7	10.5	10.0	9.2	8.5		9.9	9.0				9.0	8.3			
26.0	10.2	9.9	9.5	9.2	9.1	9.7	9.3	8.7	8.1	7.7	9.1	8.5	7.5			8.7	7.8			
28.0	8.8	9.0	8.7	8.5	8.3	8.9	8.6	8.2	7.7	7.4	8.4	8.0	7.1			8.2	7.4			
30.0	7.0	7.7	7.8	7.6	7.5	8.2	7.9	7.6	7.4	7.1	7.8	7.5	6.8			7.7	7.0			
32.0	5.4	6.0	6.8	6.9	6.7	7.1	7.1	6.9	6.7	6.6	7.1	6.9	6.4	6.0		7.2	6.6	5.9		
34.0	4.1	4.6	5.2	5.7		5.7	6.4	6.2	6.1	6.0	6.4	6.2	6.1	5.7	5.4	6.6	6.3	5.6		
36.0			3.9	4.2		4.5	5.3	5.6	5.5	5.4	5.7	5.6	5.5	5.4	5.2	5.9	5.8	5.3		
38.0						3.4	4.1	5.0	4.9	4.9	4.6	5.0	5.0	4.9	4.8	5.3	5.3	5.1	4.7	
40.0							3.1	4.0	4.4	4.4	3.6	4.5	4.5	4.4	4.4	4.8	4.8	4.7	4.5	
42.0									3.5				3.7	4.0	3.9	3.9	4.3	4.3	4.2	4.0
44.0														3.6	3.6	3.5	3.1	3.9	3.9	3.7
46.0															3.2			3.4	3.5	3.5
48.0																		3.1	3.1	3.1
50.0																		2.8	2.8	2.8

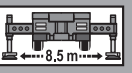
HTLJ / Tragfähigkeiten
 HTLJ / Lifting capacities
 HTLJ / Capacités de levage
 HTLJ / Capacidades de elevación

58t

DIN/ISO/EN

m	55.6 m + 2.3 m + 10.3 m					55.6 m + 2.3 m + 17.2 m					55.6 m + 2.3 m + 24.1 m					55.6 m + 2.3 m + 31.0 m				
	5°	15°	30°	45°	60°	5°	15°	30°	45°	60°	5°	15°	30°	45°	60°	5°	15°	30°	45°	60°
12.0	16.1																			
14.0	15.6	14.5																		
16.0	13.9	13.2				12.7														
18.0	12.5	12.1	11.2			11.6	10.7				10.3									
20.0	11.3	11.0	10.4	9.9	8.5	10.7	9.8				10.1					6.9				
22.0	10.3	10.0	9.6	9.2	8.2	9.8	9.1	8.3			9.3	8.5				6.9				
24.0	9.3	9.1	8.8	8.6	8.0	8.9	8.5	7.8			8.6	7.9				6.9				
26.0	8.1	8.0	7.8	7.7	7.5	8.0	7.9	7.3	6.9		8.0	7.4				6.9	6.9			
28.0	7.0	6.9	6.8	6.7	6.6	7.0	6.9	6.8	6.5	6.2	7.3	6.9	6.3			6.9	6.4			
30.0	6.1	6.0	6.0	5.9	5.8	6.1	6.1	6.1	6.0	5.9	6.5	6.5	5.9			6.5	6.0			
32.0	5.2	5.2	5.2	5.1	5.0	5.3	5.3	5.3	5.3	5.3	5.7	5.7	5.6			5.8	5.6			
34.0	4.2	4.5	4.4	4.4	4.3	4.6	4.6	4.7	4.7	4.6	5.0	5.1	5.1	4.9		5.1	5.2	4.9		
36.0		3.5	3.8	3.7	3.7	3.9	4.0	4.1	4.1	4.0	4.4	4.5	4.6	4.5	4.3	4.5	4.6	4.5		
38.0							3.4	3.5	3.5	3.5	3.8	3.9	4.0	4.1	4.0	3.9	4.1	4.1		
40.0								3.0	3.0	3.0	3.2	3.4	3.5	3.6	3.6	3.4	3.6	3.7	3.5	
42.0												2.9	3.0	3.1	3.1	3.0	3.1	3.3	3.2	
44.0									2.5	2.5			2.9	3.0	3.1	3.0	3.1	3.3	3.2	
46.0													2.6	2.7	2.7		2.7	2.9	2.9	2.8
48.0														2.3	2.3		2.3	2.5	2.6	2.6
50.0																		2.1	2.3	2.3
																			1.9	2.0





58t

DIN/ISO/EN

m	60.0 m + 2.3 m + 10.3 m					60.0 m + 2.3 m + 17.2 m					60.0 m + 2.3 m + 24.1 m					60.0 m + 2.3 m + 31.0 m				
	5°	15°	30°	45°	60°	5°	15°	30°	45°	60°	5°	15°	30°	45°	60°	5°	15°	30°	45°	60°
14.0	13.2																			
16.0	12.8	12.3				8.8														
18.0	11.5	11.2	10.5			8.8					7.8									
20.0	10.4	10.1	9.7	9.2		8.8	8.8				7.8					6.2				
22.0	9.4	9.2	8.9	8.6	8.3	8.8	8.8				7.8					6.2				
24.0	8.2	8.1	8.0	7.9	7.7	8.5	8.2	7.5			7.8	7.4				6.2				
26.0	7.1	7.0	7.0	6.9	6.7	7.5	7.5	7.0			7.5	6.9				6.2				
28.0	5.6	6.1	6.0	6.0	5.9	6.5	6.5	6.5	6.2		6.6	6.5				6.2				
30.0			5.2	5.1	5.1	5.6	5.7	5.7	5.7	5.7	5.8	5.9	5.3			5.8	5.4			
32.0							4.9	5.0	5.0	5.0	5.0	5.1	4.9			5.1	4.9			
34.0								4.3	4.4	4.3		4.5	4.5	4.2		4.4	4.4			
36.0									3.8	3.7			4.1	3.9			4.0	3.6		
38.0													3.5	3.5	3.5		3.5	3.3		
40.0														3.2	3.2			3.0		
42.0															2.7			2.7	2.6	
44.0																		2.4		
46.0																				2.2

MB+HTLJ

HTLJ + PS / Hubhöhen
 HTLJ + PS / Lifting heights
 HTLJ + PS / Hauteurs de levage
 HTLJ + PS / Alturas de elevación



DIN/ISO/EN

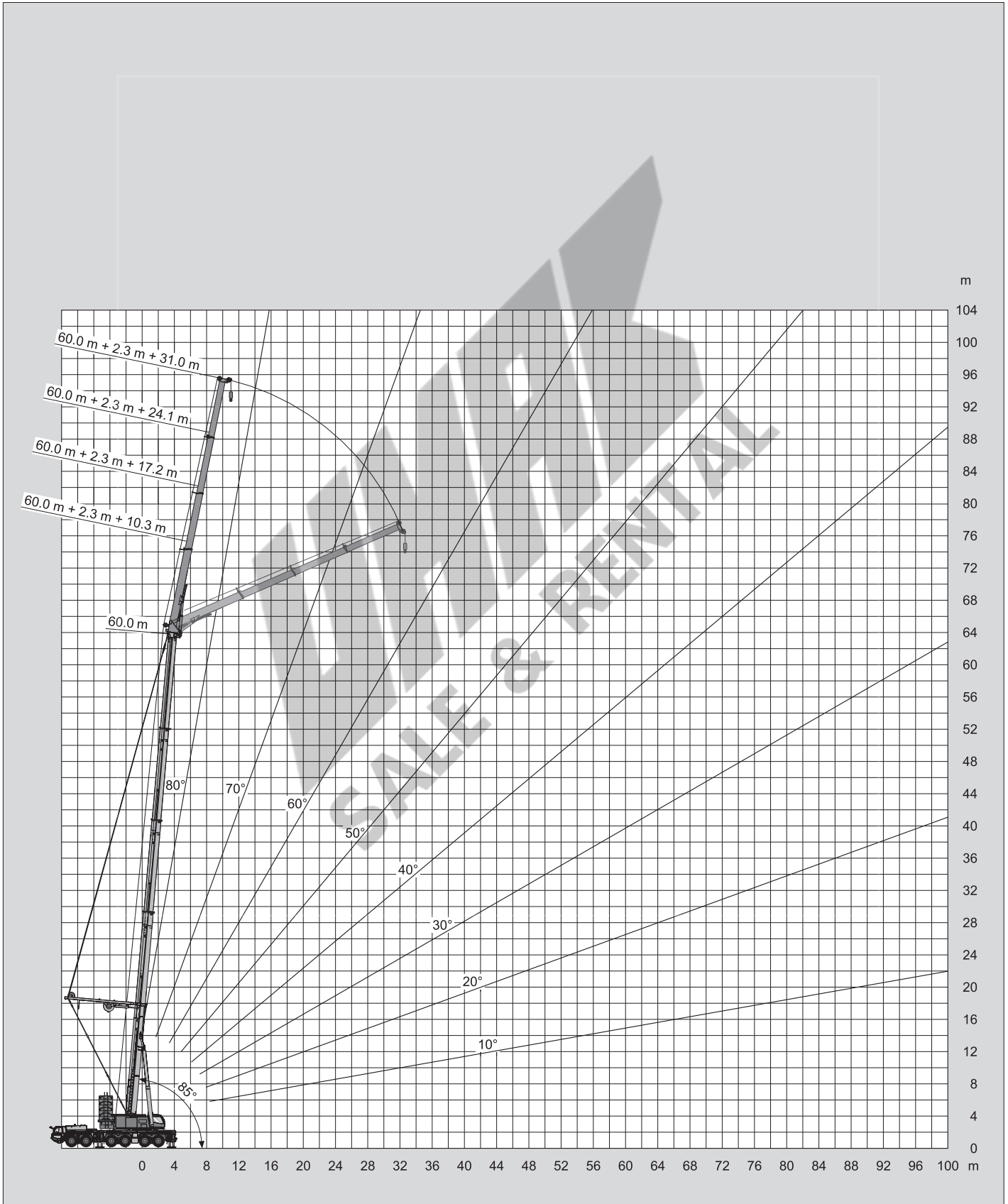

HTLJ + PS / Tragfähigkeiten
 HTLJ + PS / Lifting capacities
 HTLJ + PS / Capacités de levage
 HTLJ + PS / Capacidades de elevación

118t

DIN/ISO/EN

m	40.4 m + 2.3 m + 10.3 m					40.4 m + 2.3 m + 17.2 m					40.4 m + 2.3 m + 24.1 m					40.4 m + 2.3 m + 31.0 m					
	5°	15°	30°	45°	60°	5°	15°	30°	45°	60°	5°	15°	30°	45°	60°	5°	15°	30°	45°	60°	
9.0	38.6																				
10.0	38.6					16.7															
11.0	38.6	38.6				16.7															
12.0	38.6	38.6				16.7															
14.0	38.6	38.6	30.3	25.6		16.7	16.7				16.3										
16.0	36.3	35.0	29.0	24.8	22.8	16.7	16.7				16.0					10.9					
18.0	31.7	30.8	27.8	24.2	22.4	16.7	16.7	16.7			15.6	14.0				10.9					
20.0	27.9	27.2	26.6	23.5	22.1	16.7	16.7	16.7	14.9		15.2	13.6				10.7					
22.0	24.6	24.2	23.7	23.0	21.9	16.7	16.7	16.7	14.5	13.1	14.7	13.1	11.6			10.5	9.7				
24.0	21.8	21.5	21.2	21.1	21.2	16.7	16.7	16.3	14.1	12.9	14.2	12.7	11.3			10.3	9.3				
26.0	19.4	19.2	19.0	18.9	19.0	16.7	16.7	15.7	13.7	12.7	13.7	12.3	11.0	9.8		10.0	8.9				
28.0	17.2	17.1	17.0	17.0	17.1	16.6	16.4	15.2	13.4	12.5	13.2	12.0	10.6	9.6		9.8	8.5	7.2			
30.0	15.3	15.3	15.2	15.2		15.0	14.9	14.7	13.1	12.4	12.8	11.7	10.3	9.3	8.5	9.4	8.2	7.0			
32.0	13.6	13.6	13.6	13.7		13.5	13.4	13.5	12.8	12.3	12.4	11.4	10.0	9.1	8.4	9.1	7.9	6.7			
34.0	12.1	12.1	12.2	12.2		12.1	12.1	12.2	12.3	12.2	11.8	11.1	9.8	8.9	8.3	8.7	7.6	6.5	5.7		
36.0	10.8	10.8	10.8	10.9		10.9	11.0	11.1	11.2	11.3	10.7	10.7	9.5	8.8	8.2	8.4	7.4	6.3	5.5	5.3	
38.0	9.5	9.6	9.6	9.6		9.8	9.9	10.0	10.1		9.7	9.8	9.3	8.6	8.1	8.0	7.1	6.1	5.4	5.2	
40.0	8.4	8.5	8.5			8.8	8.9	9.0	9.1		8.8	8.9	9.1	8.4	8.1	7.7	6.9	5.9	5.3	5.1	
42.0	7.4	7.4	7.5			7.8	7.9	8.1	8.2		8.0	8.1	8.3	8.3	8.0	7.5	6.7	5.8	5.2	5.1	
44.0	6.4	6.5	6.5			7.0	7.1	7.2	7.3		7.2	7.3	7.6	7.8		7.2	6.4	5.6	5.2	5.0	
46.0	5.4	5.6				6.2	6.3	6.4			6.5	6.6	6.9	7.1		6.7	6.3	5.5	5.1	5.0	
48.0	2.7	3.1				5.4	5.6	5.7			5.8	6.0	6.2	6.4		6.1	6.1	5.3	5.1	5.0	
50.0						4.8	4.9	4.9			5.2	5.4	5.6	5.7		5.5	5.7	5.2	5.0	4.9	
54.0						3.5	3.6				4.1	4.2	4.4			4.5	4.7	5.0	4.9		
58.0											3.1	3.2	3.3			3.6	3.7	4.0	4.1		
62.0											2.2	2.3				2.7	2.9	3.1			
66.0																2.0	2.1	2.2			

118t

DIN/ISO/EN

m	45.4 m + 2.3 m + 10.3 m					45.4 m + 2.3 m + 17.2 m					45.4 m + 2.3 m + 24.1 m					45.4 m + 2.3 m + 31.0 m					
	5°	15°	30°	45°	60°	5°	15°	30°	45°	60°	5°	15°	30°	45°	60°	5°	15°	30°	45°	60°	
10.0	31.2																				
11.0	31.2																				
12.0	31.2	31.2				16.7															
14.0	31.2	30.3	23.8			16.7					14.3										
16.0	31.2	28.2	22.6	18.9	15.7	16.7	16.7				14.3										
18.0	29.7	26.4	21.6	18.3	15.4	16.7	16.7				14.3	13.7				10.2					
20.0	26.1	24.8	20.7	17.8	15.1	16.7	16.7	15.9			14.3	13.3				10.0					
22.0	22.9	22.5	19.9	17.3	14.9	16.7	16.7	15.2	12.7		14.1	12.9				9.8	9.4				
24.0	20.3	19.9	19.1	16.8	14.7	16.7	16.7	14.6	12.4	10.3	13.9	12.5	11.1			9.7	9.1				
26.0	17.9	17.7	17.5	16.4	14.5	16.7	16.7	14.0	12.0	10.1	13.6	12.2	10.8			9.5	8.7				
28.0	15.9	15.7	15.6	15.7	14.4	15.4	15.2	13.5	11.7	9.9	13.2	11.9	10.5	9.4		9.3	8.4				
30.0	14.0	14.0	13.9	14.0	14.0	13.7	13.7	13.0	11.4	9.8	12.8	11.6	10.2	9.1	7.5	9.2	8.1	6.9			
32.0	12.4	12.4	12.4	12.5		12.3	12.3	12.4	11.1	9.6	11.9	11.3	10.0	8.9	7.3	9.0	7.9	6.7			
34.0	10.9	11.0	11.0	11.1		11.0	11.0	11.2	10.9	9.5	10.7	10.8	9.7	8.7	7.2	8.7	7.6	6.5	5.7		
36.0	9.6	9.7	9.7	9.8		9.8	9.9	10.0	10.2	9.4	9.7	9.8	9.5	8.5	7.1	8.4	7.3	6.3	5.5		
38.0	8.5	8.5	8.6	8.6		8.7	8.9	9.0	9.2	9.3	8.8	8.9	9.1	8.3	7.0	8.1	7.1	6.1	5.4	5.2	
40.0	7.4	7.4	7.5	7.6		7.8	7.9	8.1	8.2		7.9	8.0	8.3	8.1	6.9	7.8	6.9	6.0	5.3	5.1	
42.0	6.4	6.4	6.5			6.9	7.0	7.2	7.3		7.1	7.2	7.5	7.7	6.8	7.2	6.7	5.8	5.1	5.1	
44.0	5.5	5.5	5.6			6.0	6.2	6.4	6.5		6.3	6.5	6.8	7.0	6.8	6.5	6.5	5.6	5.1	5.0	
46.0	4.6	4.7	4.8			5.3	5.4	5.6	5.7		5.6	5.8	6.1	6.3		5.9	6.1	5.5	5.1	5.0	
48.0	3.9	3.9	3.9			4.6	4.7	4.9	4.9		5.0	5.2	5.4	5.6		5.3	5.5	5.4	5.0	4.9	
50.0	3.1	3.2				3.9	4.0	4.2			4.4	4.6	4.8	5.0		4.8	5.0	5.2	5.0	4.9	
54.0	1.8	1.8				2.7	2.8	2.9			3.3	3.5	3.7	3.8		3.7	4.0	4.3	4.5		
58.0						1.7	1.7				2.3	2.5	2.7			1.9	2.2	2.4	2.2		
62.0											1.5	1.6	1.7								

MB
+HTLJ+PS

HTLJ + PS / Tragfähigkeiten
 HTLJ + PS / Lifting capacities
 HTLJ + PS / Capacités de levage
 HTLJ + PS / Capacidades de elevación



DIN/ISO/EN

m	50.5 m + 2.3 m + 10.3 m					50.4 m + 2.3 m + 17.2 m					50.4 m + 2.3 m + 24.1 m					50.4 m + 2.3 m + 31.0 m				
	5°	15°	30°	45°	60°	5°	15°	30°	45°	60°	5°	15°	30°	45°	60°	5°	15°	30°	45°	60°
11.0	25.2																			
12.0	25.1																			
14.0	23.0	20.4				16.7														
16.0	21.2	19.0	16.7	14.1		16.7	15.5				12.3									
18.0	19.7	17.8	15.7	13.6	11.0	16.6	14.5				12.3					8.9				
20.0	18.4	16.6	14.8	13.1	10.7	15.5	13.6	11.7			12.3	11.5				8.9				
22.0	17.2	15.6	14.0	12.6	10.5	14.5	12.8	11.1	10.0		12.3	10.9				8.9				
24.0	16.1	14.8	13.3	12.3	10.3	13.5	12.1	10.6	9.6	8.0	11.7	10.2				8.9	8.8			
26.0	15.1	13.9	12.7	11.9	10.1	12.7	11.4	10.0	9.2	7.8	10.9	9.7	8.4			8.9	8.7			
28.0	14.3	13.2	12.1	11.4	9.9	12.0	10.8	9.6	8.8	7.6	10.3	9.1	8.0			8.9	8.3			
30.0	13.2	12.6	11.6	11.0	9.7	11.3	10.2	9.1	8.4	7.5	9.7	8.7	7.6	6.9		8.8	7.8	6.8		
32.0	11.7	11.7	11.1	10.5	9.6	10.7	9.7	8.7	8.1	7.3	9.2	8.2	7.2	6.6	6.2	8.4	7.4	6.5		
34.0	10.3	10.3	10.3	10.2	9.5	10.1	9.3	8.3	7.8	7.2	8.7	7.8	6.9	6.4	5.9	7.9	7.1	6.2		
36.0	9.0	9.1	9.2	9.2		9.2	8.8	8.0	7.5	7.1	8.2	7.4	6.6	6.0	5.7	7.5	6.7	5.9	5.4	
38.0	7.9	8.0	8.0	8.1		8.2	8.2	7.7	7.1	6.9	7.8	7.1	6.3	5.7	5.4	7.1	6.4	5.6	5.1	4.7
40.0	6.8	6.9	7.0	7.1		7.2	7.3	7.3	6.8	6.6	7.3	6.7	5.9	5.4	5.1	6.7	6.1	5.3	4.8	4.4
42.0	5.9	6.0	6.1	6.1		6.3	6.5	6.7	6.5		6.5	6.3	5.6	5.2	4.9	6.4	5.7	5.0	4.5	4.2
44.0	5.0	5.1	5.2	5.2		5.5	5.7	5.9	6.0		5.8	5.9	5.3	4.9	4.7	6.0	5.4	4.7	4.3	4.0
46.0	4.2	4.3	4.4			4.8	5.0	5.1	5.3		5.1	5.3	5.0	4.7	4.5	5.4	5.1	4.5	4.1	3.8
48.0	3.4	3.5	3.6			4.1	4.3	4.5	4.6		4.5	4.7	4.7	4.4	4.3	4.8	4.7	4.2	3.8	3.6
50.0	2.7	2.8	2.9			3.5	3.6	3.8	3.9		3.9	4.1	4.4	4.2		4.3	4.5	4.0	3.6	3.5
54.0	1.5	1.5				2.3	2.5	2.6			2.8	3.1	3.3	3.5		3.3	3.5	3.5	3.3	3.1
58.0								1.5				1.5	1.6			2.4	2.6	2.9	2.9	
62.0																1.6	1.9	2.1	2.3	



DIN/ISO/EN

m	55.6 m + 2.3 m + 10.3 m					55.6 m + 2.3 m + 17.2 m					55.6 m + 2.3 m + 24.1 m					55.6 m + 2.3 m + 31.0 m					
	5°	15°	30°	45°	60°	5°	15°	30°	45°	60°	5°	15°	30°	45°	60°	5°	15°	30°	45°	60°	
12.0	15.3																				
14.0	15.3	15.3				12.5															
16.0	15.3	15.3	14.5			12.5															
18.0	15.3	15.0	13.5	11.1	8.8	12.5	12.5				9.7										
20.0	15.1	13.9	12.6	10.7	8.5	12.5	11.7				9.7					6.6					
22.0	14.0	13.0	11.8	10.3	8.2	12.1	10.9	9.7			9.7	9.7				6.6					
24.0	13.0	12.1	11.1	9.9	8.0	11.2	10.2	9.1	8.4		9.7	9.3				6.6					
26.0	12.1	11.3	10.5	9.6	7.8	10.5	9.6	8.6	8.0	7.6	9.6	8.7	7.7			6.6	6.6				
28.0	11.3	10.5	9.7	9.2	7.6	9.8	9.0	8.1	7.5	7.1	9.0	8.1	7.2			6.6	6.6				
30.0	10.3	9.7	9.0	8.5	7.5	9.0	8.2	7.5	6.9	6.6	8.4	7.7	6.8	6.3		6.6	6.6				
32.0	9.4	8.9	8.3	7.9	7.3	8.2	7.6	6.9	6.4	6.1	7.7	7.0	6.3	5.8	5.5	6.6	6.5	5.7			
34.0	8.7	8.2	7.6	7.3	7.1	7.5	7.0	6.4	6.0	5.7	7.1	6.5	5.8	5.4	5.1	6.5	5.9	5.3			
36.0	7.9	7.5	7.0	6.8	6.6	6.9	6.4	5.9	5.5	5.3	6.5	6.0	5.4	5.0	4.7	6.0	5.5	4.9	4.5		
38.0	7.3	6.9	6.5	6.3		6.3	5.9	5.4	5.1	4.9	5.9	5.5	5.0	4.6	4.4	5.5	5.0	4.5	4.2		
40.0	6.4	6.3	6.0	5.8		5.7	5.4	5.0	4.7	4.6	5.4	5.0	4.6	4.3	4.1	5.0	4.6	4.2	3.9	3.7	
42.0	5.4	5.5	5.5	5.3		5.2	4.9	4.6	4.3	4.2	5.0	4.6	4.2	4.0	3.8	4.6	4.2	3.8	3.6	3.4	
44.0	4.6	4.7	4.8	4.8		4.8	4.5	4.2	4.0		4.5	4.2	3.9	3.7	3.5	4.2	3.9	3.5	3.3	3.1	
46.0	3.8	3.9	4.0	4.0		4.3	4.1	3.8	3.7		4.1	3.9	3.6	3.4	3.2	3.8	3.5	3.2	3.0	2.9	
48.0	3.0	3.1	3.2	3.3		3.7	3.7	3.5	3.4		3.7	3.5	3.3	3.1	3.0	3.5	3.2	3.0	2.8	2.7	
50.0	2.4	2.5	2.5			3.0	3.2	3.2	3.1		3.4	3.2	3.0	2.8	2.7	3.1	2.9	2.7	2.5	2.4	
54.0						1.9	2.1	2.3	2.2		2.5	2.6	2.4	2.3		2.5	2.4	2.2	2.1	2.0	
58.0											1.6	1.8	2.0	1.9		2.0	1.9	1.8	1.7		
62.0																	1.5				

HTLJ + PS / Tragfähigkeiten
 HTLJ + PS / Lifting capacities
 HTLJ + PS / Capacités de levage
 HTLJ + PS / Capacidades de elevación



m	60.0 m + 2.3 m + 10.3 m					60.0 m + 2.3 m + 17.2 m					60.0 m + 2.3 m + 24.1 m					60.0 m + 2.3 m + 31.0 m					
	5°	15°	30°	45°	60°	5°	15°	30°	45°	60°	5°	15°	30°	45°	60°	5°	15°	30°	45°	60°	
14.0	12.6																				
16.0	12.6	12.6				8.4															
18.0	12.6	12.6	12.6	11.9		8.4	8.4				7.4										
20.0	12.6	12.6	12.0	11.2	10.7	8.4	8.4				7.4					5.9					
22.0	12.6	12.2	11.2	10.4	10.0	8.4	8.4	8.4			7.4	7.4				5.9					
24.0	12.3	11.4	10.3	9.5	9.2	8.4	8.4	8.4			7.4	7.4				5.9					
26.0	11.4	10.5	9.4	8.7	8.5	8.4	8.4	7.7	7.0	6.6	7.4	7.4				5.9	5.9				
28.0	10.3	9.4	8.5	8.0	7.8	8.4	8.1	7.1	6.4	6.1	7.4	6.9	5.9			5.9	5.9				
30.0	9.3	8.5	7.7	7.3	7.1	8.2	7.3	6.4	5.9	5.7	7.1	6.3	5.4			5.9	5.5				
32.0	8.3	7.7	7.0	6.6	6.5	7.3	6.6	5.9	5.4	5.2	6.4	5.7	5.0	4.5		5.7	5.0				
34.0	7.5	6.9	6.4	6.0	6.0	6.6	6.0	5.4	5.0	4.8	5.8	5.2	4.5	4.2	4.0	5.2	4.6	4.0			
36.0	6.7	6.2	5.7	5.5	5.5	5.9	5.4	4.9	4.5	4.4	5.2	4.7	4.1	3.8	3.6	4.7	4.2	3.7			
38.0	6.0	5.6	5.2	5.0	5.0	5.3	4.9	4.4	4.1	4.0	4.7	4.2	3.8	3.5	3.3	4.2	3.8	3.3	3.1		
40.0	5.3	5.0	4.6	4.5		4.7	4.4	4.0	3.8	3.7	4.2	3.8	3.4	3.2	3.1	3.8	3.4	3.0	2.8		
42.0	4.6	4.4	4.2	4.0		4.2	3.9	3.6	3.4	3.3	3.7	3.4	3.1	2.9	2.8	3.4	3.1	2.7	2.5	2.4	
44.0	3.8	3.9	3.7	3.6		3.8	3.5	3.2	3.1	3.0	3.3	3.0	2.8	2.6	2.5	3.0	2.7	2.5	2.3	2.2	
46.0	3.0	3.1	3.3	3.2		3.3	3.1	2.9	2.7		2.9	2.7	2.5	2.3	2.3	2.7	2.4	2.2	2.1	2.0	
48.0	2.3	2.4	2.6	2.6		2.9	2.7	2.5	2.4		2.6	2.4	2.2	2.1	2.0	2.3	2.2	2.0	1.8	1.8	
50.0	1.6	1.8	1.9	1.9		2.4	2.4	2.2	2.1		2.2	2.1	1.9	1.8	1.8	2.0	1.9	1.7	1.6	1.6	
54.0							1.5	1.6	1.6		1.6	1.5				1.5					

WORLDWIDE
SALE & RENTAL

Anmerkungen zu den Traglasttabellen Remarks relating to the rating charts Remarques relatives aux tableaux des charges Notas relativas a los graficos de carga

Anmerkungen zu den Traglasttabellen

Die Tragfähigkeiten im Festigkeitsbereich basieren auf DIN 15018 Blatt 2 und Blatt 3 und F.E.M.

Die Tragfähigkeiten im Standsicherheitsbereich entsprechen DIN 15019 Teil 2 / ISO 4305 / EN 13000.

In Abhängigkeit der Auslegerlänge sind bei den Traglasttabellen Windgeschwindigkeiten von max. 10 m/s am Teleskopausleger und max. 7 m/s mit der Auslegerverlängerung zulässig.

Die Tragfähigkeiten sind in metrischen Tonnen angegeben.



Das Gewicht des Lasthakens bzw. der Hakenflasche und weiterer Anschlagmittel ist von der Tragfähigkeit abzuziehen.

Die Tragfähigkeiten für den Teleskopausleger gelten nur bei demontierter Spitze.

Die Ausladung ist der horizontale Abstand von Mitte Drehkranz bis Mitte freihängender, nicht schwingender Last.

Für Lasten über 157 t Zusatzrollen im Rollenkopf erforderlich.

Für bestimmte Lastfälle ist der Einsatz der 2. Hubwinde erforderlich.

	MB	25,1 m	30,2 m	35,3 m
	max. t	> 154,4	> 131,4	> 108,1

Tragfähigkeitsänderungen vorbehalten.

Obige Angaben dienen nur zur Information. Die Bedienungsanleitungen müssen zu Rate gezogen werden, bevor die Maschine in Betrieb genommen wird. Alle hier gemachten Angaben beziehen sich auf die Standard-Ausführung. Jegliche Ausrüstungsveränderungen können die angegebenen Werte beeinflussen.

Remarks relating to the rating charts

The lifting capacities in the structural area are based on DIN 15018 parts 2 and 3 and F.E.M.

The lifting capacities in the stability area are based on DIN 15019 part 2 / ISO 4305 / EN 13000.

Maximum admissible wind velocity for working with telescopic boom is 10 m/sec to 7 m/sec depending at boom length and for working with fly jib 7 m/sec.

The lifting capacities are shown in metric tons.



The weight of load handling devices such as hook blocks, slings, etc., must be considered as part of the load and must be deducted from the lifting capacities.

The lifting capacities for the telescopic boom apply to a crane with no boom extensions being stowed or mounted on the crane.

The working radius is the horizontal distance from the centre of rotation to the centre of the freely suspended non-oscillating load.

Additional sheaves for boom head essential for loads bigger than 157 t.

2. Winch is essential for particular loads.

	MB	25.1 m	30.2 m	35.3 m
	max. t	> 154.4	> 131.4	> 108.1

The lifting capacities are subject to change without prior notice.

The above remarks are for basic information only and the operator's manual must be consulted before operating this crane. All data and performances refer to the standard crane. The addition of optional and other equipment may affect the performance of the crane.

Remarques relatives aux tableaux des charges

Les forces de levage sont conformes aux normes DIN 15018, p. 2 et 3, et F.E.M.

Les forces de levage dans la partie de stabilité au renversement sont conformes aux normes DIN 15019, chap. 2 / ISO 4305 / EN 13000.

Des vitesses de vent sont admissibles entre 7 m/s jusqu'à max 10 m/s en fonction de la longueur de flèche.

Les forces de levage sont données en tonnes métriques.



Le poids du crochet-moufle et de tous les accessoires d'élingage font partie de la charge et sont à déduire des charges indiquées.

Les forces de levage indiquées pour la flèche télescopique s'entendent flèche déposée.

Comme portée, on entend la distance horizontale du centre de la couronne de rotation au centre de la charge librement suspendue et non oscillante.

Pour des charges supérieures à 157 t, des poulies supplémentaires sont nécessaires sur la tête de flèche.

Un 2^{ème} treuil est nécessaire pour les levages spéciaux.

	MB	25,1 m	30,2 m	35,3 m
	max. t	> 154,4	> 131,4	> 108,1

Sauf modification de forces de levage.

Les données ci-dessus servent à titre d'information. Avant la mise en marche de la grue il est conseillé d'étudier les instructions de service. Toutes les données indiquées ci-dessus se réfèrent à la machine de base. Tout changement de l'équipement de la grue peut influencer ces valeurs.

Notas relativas a los graficos de carga

En cuanto a los datos referentes a resistencia, las capacidades de carga están basados sobre las normas DIN 15018, pág. 2 y 3, y F.E.M.

En cuanto a los datos referentes a estabilidad anti-vuelco, las capacidades de carga están basados sobre las normas DIN 15019, Cap. 2 / ISO 4305 / EN 13000.

En independencia a la longitud de la pluma, están toleradas velocidades de viento de entre 7 m/s y 10 m/s.

Las capacidades de carga indicadas en las tablas corresponden a toneladas métricas.



Hay que deducir los pesos del gancho, eslingas y de otros dispositivos para fijación de cargas de los valores indicados en las tablas.

Las capacidades de carga referentes a la pluma telescópica valen solamente si el plumín está desmontada.

Como alcance se entiende la distancia horizontal desde el centro de la corona de giro hasta el centro de la carga suspendida libremente y no oscilante.

Para cargar superiores a 157 t / es necesario poleas adicionales en cabeza de pluma.

Para posibles trabajos es necesario el montaje del 2º cabestrante.

	MB	25,1 m	30,2 m	35,3 m
	max. t	> 154,4	> 131,4	> 108,1

Salvo modificación de capacidades de carga, sin previo aviso.

Los datos arriba indicados sirven solamente para su información. Hay que leer las instrucciones para el uso antes de la puesta en servicio de la máquina. Todos los datos mencionados en las presentes tablas rigen para los modelos standard. Cualquier modificación del equipo montado puede dar lugar a modificaciones de aquellos valores.



Rahmen Verwindungs- und biegesteife Schweißkonstruktion aus hochfestem Feinkornstahl. Zentralschmieranlage.

Abstützung 4-Punkt-Abstützung, hydraulisch, Bedienungsmöglichkeiten an beiden Seiten des Fahrgestelles und in der Oberwagenkabine.
Abstützbasis 8,5 m (und 8,0 m, 6,8 m, 5,5 m) x 8,9 m.

Motor Mercedes-Benz 8-Zylinder-Dieselmotor OM 502 LA (Euromot III B), wassergekühlt, Leistung 480 kW (653 PS) bei 1800 min⁻¹.
Drehmoment 3000 Nm (306 kpm) bei 1300 min⁻¹.
Motorleistung nach 80 / 1269 / EWG. Kraftstoffbehälter 450 l. AdBlue-Behälter 40 l.

Getriebe ZF-TC-Tronic "Heavy Duty", mechanisches Schaltgetriebe mit Wandlerschaltkupplung und integriertem Intarder, elektronisch-pneumatisch betätigter Trockenkupplung und vollautomatischer Schaltung mit 12 Vorwärts- und 2 Rückwärtsgängen. Power and Economy Modus wählbar.

Antrieb 12 x 8 x 12

Achsen

1. Achse: gelenkt, angetrieben, Differentialsperre quer.
2. Achse: gelenkt, nicht angetrieben.
3. Achse: gelenkt, angetrieben, Differentialsperre längs und quer.
4. Achse: gelenkt, angetrieben, Differentialsperre quer.
5. Achse: gelenkt, angetrieben, Differentialsperre quer.
6. Achse: gelenkt, nicht angetrieben.

Achsaufhängung Hydropneumatische Federung mit Niveauregulierung.

Bremsen Druckluft-Zweikreis-Scheibenbremsanlage. Feststellbremse als Federspeicherbremse an der 3., 4., 5. und 6. Achse wirkend. Intarder mit Bremsomat-Funktion und Konstantdrosselanlage mit Auspuffklappenbremse als Dauerbremse.

Räder 12-fach 445/95 R 25 (16.00 R 25).

Lenkung ZF-Servocom-Zweikreis-Hydraulenlenkung mit Notlenkpumpe. Mechanische Lenkung der 1. und 2. Achse.
Im Betriebsmodus "Straße" werden die Achsen 3-6 bis zu einer Geschwindigkeit von 30 km/h elektronisch mitgelenkt.
Ab einer Geschwindigkeit von 30 km/h werden die Achsen 4 und 5 in in Geradeausposition verriegelt und ab einer Geschwindigkeit von 50 km/h zusätzlich die Achsen 3 und 6.

Unterbaukabine Zwei-Mann-Frontfahrerhaus in Stahl-Kunststoff-Verbund-Konstruktion, Sicherheitsverglasung, luftgedeckelte Sitze (Fahrersitz mit Heizung) und motorabhängige Warmwasserheizung, Klimaanlage, Radio-CD-Player, Kontroll- und Bedienungselemente für den Fahrbetrieb, Tempomat- / Bremsomat-Funktion.

Elektrische Anlage 24 Volt-Gleichstrom, 2 Batterien, Verdrahtung mit CAN-Bus-Komponenten, integrierte Eigendiagnose Faun-CSS-System, Abstützbeleuchtung.
Die elektrische Anlage entspricht der EG-Norm.

Zusatzrüstung (gegen Mehrpreis)
Anhängerkupplung, motorunabhängige Zusatzheizung mit Motorvorwärmung, ABS, 525/80 R 25 (20.5 R 25) Bereifung, Reserverad, Sonderlackierung und Beschriftung.
Weitere Zusatzrüstung auf Anfrage.

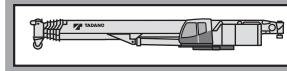

Rahmen Verwindungssteife Schweißkonstruktion mit einer außenverzahnten, dreireihigen Rollendrehverbindung, um 360° unbegrenzt drehbar. Zentralschmieranlage.

Motor Mercedes-Benz 6-Zylinder-Dieselmotor OM 926 LA (Euromot III B), wassergekühlt. Drehzahl ist über Fußpedal stufenlos regelbar, Leistung 195 kW (265 PS) bei 2200 min⁻¹.
Drehmoment 1100 Nm (112 kpm) bei 1200 - 1600 min⁻¹, Motorleistung nach DIN 6270B / DIN 6271.
Kraftstoffbehälter 230 l. AdBlue-Behälter: 8 l.

Hydraulik System Diesel-hydraulisch mit 3-Kreis-Hydraulik, 1 leistungsgeregelte Axialkolben-Doppelpumpe (hydraulisch verstellbar), 1 Axialkolbenpumpe und 1 Zahnradpumpe, Ölkühler.

Steuerung Zwei 4-fach Kreuzsteuerhebel mit elektrischer Vorsteuerung.

Teleskopausleger Fünfteiliger Teleskopausleger aus hochfestem Feinkornstahl, bestehend aus einem Grundaussleger und 4 Teleskopteilen, 1 Teleskopzylinder, hydraulisch unter Teillast teleskopierbar. 15,0 m - 60,0 m lang.

Wippwerk Ein Differentialzylinder mit angebautem Senkbremssperrventil.

Hubwerk Axialkolben-Verstell-Motor, Hubwerkstrommel mit eingebautem Planetengetriebe und federbelasteter Hydro-Lamellenbremse mit integriertem Freilauf beim Heben. Hubseil mit 'Super-Stop' Einrichtung.

Drehwerk Axialkolben-Motor, dreistufiges Planetengetriebe mit automatischer Betriebs- und Feststellbremse. Offener Hydraulikkreislauf mit Drehwerk-Freischaltung.
Drehgeschwindigkeit stufenlos von 0 - 1,1 min⁻¹.

Gegengewicht Gesamtgewicht 138 t teilbar.
Die Bedienung erfolgt mittels einer Fernbedieneinheit.

Oberwagenkabine Großräumige Krankabine in Stahl-Kunststoffausführung mit Sicherheitsverglasung und getönten Scheiben, kippbarem Arbeitsplatz mit verstellbarem, hydraulisch gedämpftem Fahrersitz mit Heizung, motorabhängige und motorunabhängige Warmwasserheizung (mit Motorvorwärmung), Klimaanlage, Radio-CD-Player, Kontroll- und Bedienungselemente sowie graphische LCD-Anzeige für Kranbetrieb.

Elektrische Anlage 24 Volt-Gleichstrom, 2 Batterien.

Sicherheitseinrichtungen 'Lift- und 'Release Adjuster' (automatische Überwachung des Arbeitsradius in Folge Auslegerverformung durch Lasteinwirkung), Lastmomentbegrenzung (LMB), Windmesser, Arbeitsbereichsbegrenzung, Hubendschalter, Windenendschalter, Seilwindendrehmelder, Sicherheitsventile gegen Rohr- und Schlauchbrüche. Sperrventile an Hydraulik-Zylindern.

Zusatzrüstung (gegen Mehrpreis)
Power-System PS, Auslegerverlängerungen: Light fixed jib 6,0 m - 24,0 m, Fixed jib 13,5 m - 49,5 m, Luffing jib 20,3 m - 76,0 m und HTLJ 10,3 m - 31,0 m, Unterflaschen von 12,5 t bis 250 t, 2. Hubwerk, Zusatzölkühler, Sonderlackierung und Beschriftung.
Weitere Zusatzrüstung auf Anfrage.

Equipment

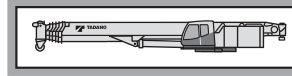

Frame Torsion resistant, welded construction made from high strength, fine-grained steel. Central lubricating system.

Outriggers 4 point, double telescopic hydraulic outriggers with controls on both sides of carrier and in superstructure cab. Outrigger base 8,5 m (8.0 m, 6.8 m, 5.5 m mid extension) x 8.9 m.

Carrier engine Mercedes-Benz 8 cylinder model OM 502 LA (Euromot III B), water-cooled diesel engine. Rated at 480 kW (653 HP) at 1800 min⁻¹. Torque 3000 Nm (306 kpm) at 1300 min⁻¹. Engine rating according to 80/1269/EWG. Fuel tank 450 l. AdBlue-tank 40 l.

Transmission ZF-TC-Tronic HD transmission in "heavy duty" version with torque converter and integrated interarder, electro-pneumatically operated dry-type clutch and automatic gear shifting with 12 forward gears and 2 reverse gears. Power/Economy mode.

Drive 12 x 8 x 12

Axles

1st axle: steered, driven.
 2nd axle: steered, not driven.
 3rd axle: steered, driven, with longitudinal differential lock.
 4th axle: steered, driven.
 5th axle: steered, driven.
 6th axle: steered, not driven.
 All driven axles with transverse differential locks.

Suspension Hydro-pneumatic with levelling adjustment.

Brake system Service disc brakes: dual circuit compressed air system. Parking brake: spring loaded type acting on 3rd, 4th, 5th and 6th axles. Auxiliary brakes: interarder with 'Bremsomat' function, engine exhaust brake and constant throttle engine brake system.

Tyres (12) 445/95 R 25 (16.00 R 25).

Steering system ZF-Servocom, dual circuit hydraulic steering with emergency steering pump, mechanical hydraulically-assisted steering of front two axles. On road mode the 1st and 2nd axle are permanently steered and mechanically connected to the steering gear unit and the 3rd, 4th, 5th and 6th axle are automatically steered, electro-hydraulically, with the 1st and 2nd axles up to a travel speed of 30 km/h and 50 km/h respectively. At a speed of 30 km/h, the 4th and 5th axles are automatically locked in the straight ahead position. At a speed of 50 km/h, the 3rd and 6th axle is automatically locked in the straight ahead position.

Carrier cab Two man full width cab of composite (steel sheet metal and fibre-glass) structure, with safety glass, air-cushioned adjustable seats (driver seat with heater) and engine dependent hot-water heater, air conditioning, radio- CD-player, complete controls and instrumentation for road travel. 'Tempomat-/Bremsomat' function.

Electrical system 24 volt DC system, 2 batteries, CAN-Bus system with Faun CSS integrated self-diagnosis system, outrigger lighting. Electrical system conforms with EEC regulations.

Optional Equipment (at extra charge)

Towing attachment, engine independent additional heater with engine pre-heat, ABS, 525/80 R 25 (20.5 R 25) tyres, spare wheel and tyre, special painting and lettering.

Further optional equipment available upon request.

Frame Torsion-resistant, all-welded structure of high strength steel. Connected to carrier by triple roller bearing slewing ring with external gearing for 360° continuous rotation. Central lubricating system.

Superstructure engine Mercedes-Benz 6 cylinder model OM 926 LA (Euromot III B), water cooled, diesel engine. PRM infinitely variable via foot pedal, rating 195 kW (265 HP) at 2200 min⁻¹. Torque 1100 Nm (112 kpm) at 1200 - 1600 min⁻¹. Engine rating according to DIN 6270B/DIN 6271. Fuel tank 230 l. AdBlue-tank 8 l.

Hydraulic system Three circuit diesel hydraulic system with 1 power controlled axial piston double pump (hydraulically adjustable) 1 axial piston pump and 1 gear pump, oil cooler.

Controls Electrical, 2 joy-stick levers for simultaneous operation of crane motions.

Telescopic boom 5 sections, made of high tensile, fine-grained steel, consisting of 1 base section and 4 telescoping sections extended by means of a single telescopic cylinder. All telescope sections extendable under partial load. 15.0 m to 60.0 m long.

Derricking system 1 double acting hydraulic cylinder with integral brake and holding valve.

Main winch Axial piston variable displacement motor, winch drum with integrated planetary reduction and with hydraulically controlled spring-loaded, multiple disc brake. Hoist cable with 'Super-Stop' easy reeving system.

Slewing system Axial piston motor with three-stage planetary gear with automatic service and a parking brake. Open hydraulic circuit with free slewing function. Speed infinitely variable 0 - 1.1 min⁻¹.

Counterweight Total 138 t divisible, assembled and disassembled by hydraulic cylinders operated by remote control.

Superstructure cab Spacious panoramic cab of composite structure with safety (tinted) glass windows, tiltable cockpit with hydraulically cushioned adjustable seat with heater, one engine dependent hot-water heater and one engine independent hot-water heater (with engine pre-heat), air conditioning, radio-CD-player. Complete controls and instrumentation plus LCD graphic display for crane operation.

Electrical system 24 volt DC system, 2 batteries.

Safety devices 'Lift- and Release Adjuster', (automatic radius correction based on boom deflection under load) load moment device (LMD), anemometer, working area limitation, hoist limit switch, lower limit switch and drum turn indicator, safety valves against pipe and hose rupture, holding valves on hydraulic cylinders.

Optional Equipment (at extra charge)

Power-System PS, boom extensions: Light fixed jib 6.0 m - 24.0 m, Fixed jib 13.5 m - 49.5 m, Luffing jib 20.3 m - 76.0 m and HTLJ 10.3 m - 31.0 m, hook blocks 12.5 t - 250 t, auxiliary winch, additional oil cooler, special painting and lettering.

Further optional equipment available upon request.

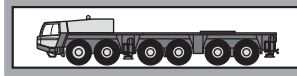

Châssis Construction mécanosoudée, en acier à grain fin très rigide, résistant aux flexions et aux torsions. Graissage centralisé.

Calage Dispositif de calage horizontal et vertical en 4 points, entièrement déployable hydrauliquement. Commande des mouvements sur les deux côtés du porteur et depuis la cabine de la superstructure.

Calage 8,5 m (8,0 m, 6,8 m, 5,5 m à mi-extension) x 8,9 m.

Moteur Mercedes Benz diesel 8 cylindres, modèle OM 502 LA (Euromot III B), refroidi par eau, de 480 kW (653 CV) à 1800 min⁻¹. Couple: 3000 Nm (275 kpm) à 1300 min⁻¹. Puissance selon 80/1269/EWG. Capacité du réservoir 450 l. AdBlue-capacité du réservoir 40 l.

Boîte de vitesse Boîte de vitesse ZF-TC-Tronic "Heavy Duty". Boîte mécanique avec convertisseur et Intarder intégré, avec embrayage électro-pneumatique à commande automatique, 12 vitesses AV et 2 vitesses AR. Mode max. performance/économique.

Entraînement 12 x 8 x 12

Essieux

1^{er} essieu: directeur, entraîné, blocage de différentiel transversal.

2^{ème} essieu: directeur, non entraîné.

3^{ème} essieu: directeur, entraîné, blocage de différentiel longitudinal et transversal.

4^{ème} essieu: directeur, entraîné, blocage de différentiel transversal.

5^{ème} essieu: directeur, entraîné, blocage de différentiel transversal.

6^{ème} essieu: directeur, non entraîné.

Suspension Hydro-pneumatique, avec réglage de niveau.

Freins Freins de service à disque: système à double circuit d'air comprimé. Frein de stationnement: avec accumulateurs à ressort agissant sur le 3^{ème}, 4^{ème}, 5^{ème} et 6^{ème} essieu. Freins continus: frein moteur par clapet sur échappement. Ralentisseur hydrodynamique Intarder.

Pneus 12 x 445/95 R 25 (16.00 R 25).

Direction Servocom à double circuit, marque ZF avec pompe de direction auxiliaire. Direction mécanique du 1^{er} et 2^{ème} essieu. En mode "route" les essieux 3 - 6 sont directionnels jusqu'à une vitesse de 30 km/h. A partir d'une vitesse de 30 km/h les essieux 4 et 5 sont verrouillés dans une droite et position à partir de 50 km/h les essieux 3 et 6 sont aussi verrouillés.

Cabine Cabine bi-place, construction en matière composite fibre de verre et acier. Vitrage en verre de sécurité, siège conducteur chauffant suspendu hydrauliquement. Chauffage à eau chaude relié au moteur, climatisation, radio-CD-player. Organes de contrôle et de commande pour la conduite. Régulateur de vitesse, système automatique de freinage.

Système électrique 24 V courant continu, 2 batteries, connexion circuit électrique avec CAN-Bus. Équipement avec prise diagnostic et avec interprétation de code erreur de système FAUN CSS, éclairage des points de calage. Conforme aux normes CE.

Équipement supplémentaire (avec supplément de prix)

Attache-remorque, chauffage auxiliaire indépendant du moteur avec préchauffage du moteur, ABS, pneus 525/80 R 25 (20.5 R 25), roue de secours, peinture spéciale et inscription.

Autres équipements supplémentaires sur demande.

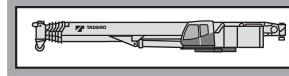

Plate forme Construction mécano-soudée résistante à la torsion. Couronne d'orientation à triple rangée de rouleaux avec denture extérieure pour une rotation à 360° en continu. Graissage centralisé.

Moteur Mercedes Benz diesel 6 cylindres, modèle OM 926 LA (Euromot III B), refroidi par eau.

Réglage du nombre de tours par pédale, de 195 kW (265 CV) à 2200 min⁻¹. Couple: 1100 Nm (112 kpm) à 1200 - 1600 min⁻¹. Puissance selon DIN 6270B/DIN 6271.

Capacité du réservoir 230 l.

AdBlue-capacité du réservoir 8 l

Système hydraulique Diesel-hydraulique à 3 circuits, 1 double pompe à pistons axiaux à régulation de puissance (à réglage hydraulique) 1 pompe à pistons axiaux et 1 pompe à engreages, refroidisseur d'huile.

Commande 2 manipulateurs à commande en croix (4 sens), assistés électriquement.

Flèche télescopique 1 flèche de base et 4 éléments télescopiques en acier fin, 1 vérin télescopique, hydrauliquement télescopable avec charge partielle. Longueur de 15,0 m à 60,0 m.

Mécanisme de relevage 1 vérin différentiel muni de clapet de freinage de descente.

Mécanisme de levage Moteur hydraulique à cylindrée variable, tambour de levage avec boîte planétaire incorporée, frein d'arrêt à disques multiples à ressort, libéré lors du levage. Câble de levage avec dispositif 'Super-Stop'.

Orientation Moteur hydraulique avec entraînement planétaire à 3 gammes avec frein de stationnement automatique. Circuit ouvert avec déconnexion de l'orientation.

Vitesse de rotation 0 à 1,1 min⁻¹ en continu.

Contrepoids Poids total 138 t divisible, assembles et démontés grâce à des vérins hydrauliques télécommandés.

Cabine du grutier Cabine de grue spacieuse, construction en matière combinée acier/synthétique, avec vitrage de sécurité en verre teinté, siège chauffant, réglable et amorti hydrauliquement, inclinable avec instruments de commande, chauffage à eau chaude dépendant et indépendant du moteur (avec préchauffage du moteur), climatisation, radio-CD-player, éléments de commande et de contrôle avec affichage digital pour travaux.

Système électrique 24 V courant continu, 2 batteries.

Dispositifs de sécurité 'Lift- et 'Release Adjuster', limiteur de charge (CEC), anémomètre, limitation de zone de travail, interrupteur de fin de course de levage et de treuil, indicateur du nombre de tours, soupapes de sécurité contre ruptures des conduites et flexibles, clapets sur verins hydraulique.

Équipement supplémentaire (avec supplément de prix)

Power-System PS, fléchette: Light fixed jib 6,0 m - 24,0 m, Fixed jib 13,5 m - 49,5 m, Luffing jib 20,3 m - 76,0 m et HTLJ 10,3 m - 31,0 m, moufles de 12,5 t à 250 t, 2^{ème} treuil de levage, refroidisseur d'huile supplémentaire, peinture spéciale et inscription.

Autres équipements supplémentaires sur demande.

Equipo

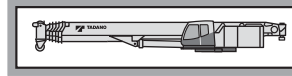

Chasis portante Construcción en acero de alta resistencia soldado, resistente a la torsión y flexión. Engrase centralizado.

Estabilizadores Estabilizadores hidráulicos de 4 puntos. Posibilidad de manejo desde ambos lados del chasis y desde la cabina de la grúa. Base de apoyo 8,5 m (variante 8,0 m, 6,8 m, 5,5 m) x 8,9 m.

Motor Mercedes Benz 8 cilindros; OM 502 LA (Euromot III B), refrigerado por agua. Potencia de 480 kW (653 CV) a 1800 min⁻¹; par 3000 Nm (275 kpm) a 1300 min⁻¹. Potencia de motor según 80/1269/EWG. Depósito de combustible de 450 l. Depósito AdBlue 40 l.

Transmisión Transmisión mecánica modelo ZF-TC Tronic "Heavy Duty". Con convertidor y embrague de puente con Intarder integrado, accionamiento electro-neumático. Embrague seco cambio automático con 12 marchas delanteras + 2 traseras. Modo rendimiento máximo/económico.

Tracción 12 x 8 x 12

Ejes

- 1º eje: direccional, accionado, con bloqueo diferencial transversal.
- 2º eje: direccional.
- 3º eje: direccional, accionado, con bloqueo diferencial transversal + longitudinal.
- 4º eje: direccional, accionado, con bloqueo diferencial transversal.
- 5º eje: direccional, accionado, con bloqueo diferencial transversal.
- 6º eje: direccional.

Suspensión Suspensión hidroneumática con regulación de nivel.

Sistemas de frenos Accionamiento neumático con frenos de disco. Frenos de estacionamiento tipo muelles cargados, en los ejes 3º, 4º, 5º y 6º. Intarder con sistema automático de frenado continuo. Sistema de estrangulador sobre el escape.

Neumáticos 12 x 445/95 R 25 (16.00 R 25).

Dirección Dirección hidráulica ZF Servocom de doble circuito y bomba auxiliar de dirección. Dirección mecánica en los ejes 1º y 2º. Ejes 3º - 6º en servicio modo circulación "carretera" acompañan la dirección hasta una velocidad de 30 km/h.

A partir de 30 km/h los ejes 4º - 5º se bloquean y quedan sin dirección.

A partir de 50 km/h quedan sin dirección los ejes 3º - 6º.

Cabina Cabina para dos personas, en construcción de acero de fibra de vidrio. Cristales de seguridad, asiento con suspensión neumática y calefactado. Calefacción por agua caliente del motor, climatización, radio-CD-player. Elementos de control e instrumentación para la circulación por carretera. Regulador de velocidad, sistema automático de frenado.

Sistema eléctrico Sistema de 24 V c.c. con dos baterías, conexiones eléctricas integradas en el sistema CAN-Bus, sistema integrado de diagnóstico Faun-CSS. Faros de trabajo en los estabilizadores. El sistema eléctrico cumple la normativa CEE.

Equipo adicional (con suplemento de precio)

Embrague de remolque, calefacción adicional con precalefacción del motor, ABS, neumáticos 525/80 R 25 (20.5 R 25), rueda de repuesto, pintura especial y rotulación.

Otros equipamientos sobre pedido.

Superestructura Construida en aceros soldados, resistente a la torsión. Corona de giro de dientes externos con un giro de 360°.

Motor Mercedes Benz 6 cilindros modelo OM 926 LA (Euromot III B), refrigerado por agua. Las revoluciones aumentan de forma gradual accionado por el acelerador. Potencia 195 kW (265 Cv) a 2200 min⁻¹. Par 1100 Nm (112 kpm) a 1200 - 1600 min⁻¹. Potencia de motor según normativa DIN 6270B / DIN 6271. Depósito de combustible 230 l; depósito de AdBlue 8 l.

Sistema hidráulico Sistema hidráulico de 3 circuitos, 1 bomba doble de pistones axiales (regulada hidráulicamente) 1 bomba axial y 1 bomba dentada. Enfriador de aceite.

Mandos 2 palancas de control de tipo joy-stick para movimientos simultáneos de la grúa (4 direcciones), asistidos eléctricamente.

Pluma telescópica Pluma telescópica compuesta de 5 tramos de acero de alta resistencia, 1 trama base + 4 tramos telescópicos, extensibles bajo carga. Longitud 15,0 m - 60,0 m.

Elevación de pluma Cilindro telescópico con válvula de anti-caída.

Cabestrante principal Motor de pistones axiales variable. Cabestrante con reducción de planetarios y frenos de disco con sistema libre de elevación. Cable de elevación con sistema fácil de guiado 'Super-Stop'.

Sistema de giro Motor hidráulico de pistones axiales con reducción planetaria de tres etapas. Circuito hidráulico abierto con posibilidad con reductor posición veleta. Velocidad de giro gravable desde 0 - 1,1 min⁻¹.

Contrapeso Peso total 138 t divisible. Accionamiento mediante mando a distancia.

Cabina de la grúa Cabina espaciosa y confortable en construcción de acero de fibra de vidrio. Con cristales tintados de seguridad. Asiento de conductor amortiguado hidráulicamente, calefactado. Calefacción independiente, climatización, radio-CD-player. Controles e instrumentación a si como display digital LCD para la operación de la grúa.







Sistema eléctrico Sistema de 24 V c.c. con dos baterías.



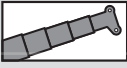
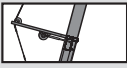
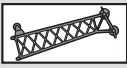

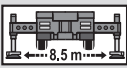

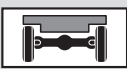
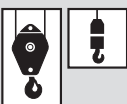
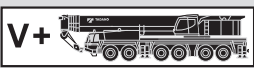

Medidas de seguridad Sistema de 'Lift- and Release Adjuster' limitación de momentos de carga (LMC). Anemómetro limitación de área de trabajo. Final de carrera, control de cabestrante, indicador de vueltas de cabestrante, válvulas de seguridad contra rotura de tuberías y latiguillos. Válvulas de cierre en cilindros hidráulicos.

Equipo adicional (con suplemento de precio)

Sistema de potencia PS; plumín: Light fixed jib 6,0 m - 24,0 m, Fixed jib 13,5 m - 49,5 m, Luffing jib 20,3 m - 76,0 m y HTLJ 10,3 m - 31,0 m Pastecas desde 12,5 t - 250 t, 2º cabestrante, enfriador adicional, pintura especial y rotulación.

Otros equipamientos sobre pedido.

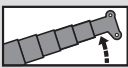
	Teleskopausleger Telescopic boom Flèche télescopique Pluma telescópica
	Power-System
	Auslegerverlängerung Boom extension Fléchette Plumin
	Auslegerverlängerung hydraulisch Boom extension hydraulically Fléchette hydrauliquement Plumin hidráulicamente
	Auslegerverlängerung HTLJ Boom extension HTLJ Fléchette HTLJ Plumin HTLJ
	Abstützung Outriggers Calage Estabilizadores
	Drehwerk Slewing system Orientation Sistema de giro
	Gegengewicht Counterweight Contrepoids Contrapeso
	Siehe Seite 116 As on Page 116 Voyez la page 116 Véase la pagina 116
	Räder / Größe Tyres / Size Pneus / Largeur Neumáticos / Tamaño de ruedas
	Achslast Axle load Charge à l'essieu Carga por eje
	Unterflasche / Hakengeschild Hook block / Swivel hook Moufle / Elingues Gancho / Gancho de bola
	Geschwindigkeiten Unterwagen Carrier speeds Vitesses du châssis Velocidades del chasis

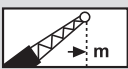
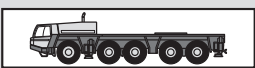
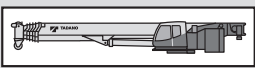
	Getriebe / Gang Transmission / Gear Boîte de vitesse / Rapport Transmisión / Marchas
	Steigfähigkeit Gradeability Abtitude en pente Superacion de pendientes
	Gelände Off road Tout-terrain Todo terreno
	Straße On road En route En carretera
	Geschwindigkeiten Oberwagen Superstructure speeds Vitesses du partie tournante Velocidades de la superestructura
	Hubwerk Main winch Mécanisme de levage Cabrestante principal
	2. Hubwerk Auxiliary winch 2ième treuil de levage 2° cabrestante
	Wippwerk Derricking system Mécanisme de releage Elevación de pluma
	Teleskopieren Boom telescoping Télescopage de flèche Telescopaje de pluma
	Ausladung Radius Portée Radio
	Ausladung Radius Portée Radio
	Unterwagen Carrier châssis chasis
	Oberwagen Superstructure partie tournante superestructura

Notizen
Notes
Notas



UNIVERSAL
SALE & RENTAL

WIMAK
SALE & RENTAL



TADANO FAUN GmbH

Faunberg 2, 91207 Lauf a. d. Pegnitz, Germany
Phone: +49-9123-185-0 Fax: +49-9123-3085
<http://www.tadanofaun.de> E-mail: info@tadanofaun.de

TADANO LTD. (International Division)

4-12, Kamezawa 2-chome, Sumida-ku Tokyo 130-0014, Japan
Phone: 81-3-3621-7750 Fax: 81-3-3621-7785
<http://www.tadano-global.com> E-mail: tdnihq@tadano.co.jp

ATF 400G-6

400 METRISCHE TONNEN TRAGLAST / 400 METRIC TON CAPACITY

**ALL
TERRAIN
CRANE**



Highlights

Highlights des ATF 400G-6:

- Einhaltung der 12 t Achslasten inkl. Antrieb 12 x 8 x 12, Bereifung 445/95 R 25 (16.00 R 25).
- Leistungsstärkstes Antriebspaket seiner Klasse mit sparsamen Mercedes Benz BlueTec Motor, 480 kW Leistung und 3000 Nm Drehmoment sowie einem hochtechnisiertem ZF-TC-Tronic HD Getriebe in "Heavy Duty" Ausführung.
- Separater Oberwagenmotor von Mercedes Benz mit BlueTec Technologie und 195 kW Leistung und 1100 Nm Drehmoment.
- Der 60 m Hauptausleger erreicht die höchsten Traglastwerte seiner Klasse. Zum Vergrößern der Traglasten kann er zusätzlich mit einem "Power System" ausgerüstet werden.
- Vollhydraulisch abwinkelbare und teleskopierbare Auslegerverlängerung (HTLJ) für effizientes Arbeiten und Montage auf engstem Raum (Funktion wie zusätzlicher Teleskopausleger).
- Fahrzeugbreite innerhalb von 3 m bei einem Gegengewicht bis zu 25 t.
- Das Sicherheitsprogramm 'Lift- und Release Adjuster' unterbindet das gefährliche Pendeln der Last, bzw. des Hakens und sorgt somit für höchste Sicherheit und äußerst kontrollierbare Hubbewegungen bei jedem Einsatz.
- Effiziente Serviceplanung sowie Durchführung von Fehlerferndiagnosen/-behebungen mit Unterstützung der Online-Kommunikation zwischen Kranhersteller, Kranbetreiber und Kran (Hello-Net).

Points forts de l' ATF 400G-6:

- 12 t par essieu avec entraînement 12 x 8 x 12, pneus 445/95 R 25 (16.00 R 25).
- La chaîne d'entraînement la plus performante de sa catégorie avec le dernier développement et un moteur Mercedes Benz Blue Tec sophistiqué qui économise le plus la consommation de gazole, puissance 480 kW et 3000 Nm couple ainsi qu'une transmission haute technologie ZF-TC-Tronic HD transmission en version « poids lourds ».
- Moteur Mercedes Benz BlueTec pour la superstructure, puissance 195 kW et 1100 Nm couple.
- La flèche principale de 60 m atteint la plus grande capacité dans sa classe. La flèche principale peut être équipée en supplément avec le « Power System » pour augmenter la capacité de levage.
- Le système de la fléchette avec inclinaison et télescopage hydraulique (HTLJ) est conçu pour les opérations dans des espaces limités. (comme une flèche additionnelle au bout de la flèche télescopique).
- Jusqu'à 25 t de contrepoids la largeur du véhicule n'est pas dépassé.
- Les dispositifs de sécurité 'Lift- et Release Adjuster' évitent le balancement dangereux de la charge et du moufle et garantissent une sécurité supérieure et mouvement de levage qui sont contrôlables sur chaque levage.
- Planning du service efficient ainsi qu'un diagnostic de dysfonctionnement, ajustement et corrections peuvent être opérés par communication en ligne (Hello-Net) entre le fabricant, le client et la grue.

Highlights of the ATF 400G-6:

- 12 t axle load including drive 12 x 8 x 12, tyres 445/95 R 25 (16.00 R 25).
- The most powerful drive system in his class with the latest state of the art fuel saving Mercedes Benz BlueTec engine, 480 kW engine power and 3000 Nm torque as well as a high technology ZF-TC-Tronic HD transmission in "heavy duty" version.
- Separate superstructure engine Mercedes Benz BlueTec engine, 195 kW engine power and 1100 Nm torque.
- The 60 m main boom achieves the highest capacity in his class. The main boom can be additionally equipped with the "Power System" to increase the lifting capacity.
- The Hydraulic Telescopic Luffing Jib (HTLJ) is made to be fitted and operate in narrow areas (like an additional telescopic boom on top of the main telescopic boom).
- With up to 25 t counterweight the vehicle width is not exceeded.
- The safety features 'Lift- and Release Adjuster' avoiding of dangerous swing of the load and the hook block and providing highest safety and controllable lifting motions on each job.
- Efficient Service planning as well as malfunction diagnostic, adjustment and corrections can be made via online-communication (Hello-Net) between the manufacturer, the client and the crane.

Highlights del ATF 400G-6:

- Peso por eje de 12 t incluido, tracción 12 x 8 x 12, neumáticos 445/95 R 25 (16.00 R 25).
- Paquete de potencia con motor Mercedes Benz BlueTec 480 kW y 3000 Nm de par motor. Caja de cambios de alta tecnología modelo ZF-TC en versión "heavy duty".
- Motor independiente de grúa Mercedes Benz Blue Tec de 195 kW y 1100 Nm de par motor.
- Longitud de pluma de 60 m. Con las mejores tablas de carga en su categoría. Mejora de tablas de carga con el montaje adicional del "Power System".
- Plumin adicional con funciones hidráulicas de telescopaje y angulación (HTLJ). Optimización de espacios en zonas reducidas (funciona como pluma adicional tipo JIB).
- Ancho de maquina de 3 m incluido contrapeso de hasta 25 t.
- Programa de seguridad 'Lift- and Release Adjuster', controla los posibles movimientos oscilantes del gancho, asegurado en cada movimiento el máximo control de la carga.
- Planificación eficiente de servicio técnico mediante un servicio de diagnosis de averías Online de comunicación creando una red entre Fabricante – Usuario – Grúa (Hello-Net).

Seite / Page Page / Pagina	Gegengewicht / Counterweight Contrepoids / Contrapeso	Systemübersicht / General survey of the system Vue d'ensemble du système / Sistema de vigilancia	
4-7		Auslegerverlängerungen / Boom extensions / Fléchette / Plumín	1
8-9		Gegengewichtvarianten / Counterweight versions / Variations des contrepoids / Variaciones de contrapeso	
10-11		Maße + Gewichte / Geschwindigkeiten / Dimensions + Weights / Working speeds / Dimensiones + Poids / Vitesses / Dimensiones + Pesos / Velocidades de trabajo	
12-15	98 t / 78 t / 58 t	MB	2
16-18	47 t / 36 t / 25 t / 16.5 t / 7.5 t	Teleskopausleger / Telescopic boom / Flèche télescopique / Pluma telescópica	
19	0 t		
20-21	98 t	MB + LFJ	3
22	58 t	Teleskopausleger / Telescopic boom / Flèche télescopique / Pluma telescópica + Light fixed jib	
24-25	98 t / 58 t Heavy Duty	MB + Heavy Duty	4
		Teleskopausleger / Telescopic boom / Flèche télescopique / Pluma telescópica + Heavy Duty	
26-33	98 t / 58 t	MB + FJ	5
		Teleskopausleger / Telescopic boom / Flèche télescopique / Pluma telescópica + Fixed jib	
34-39	98 t / 58 t	MB + HTLJ	6
		Teleskopausleger / Telescopic boom / Flèche télescopique / Pluma telescópica + Hydraulic telescopic luffing jib	
40		Anmerkungen zu den Traglasttabellen / Remarks relating to the rating charts / Remarques relatives aux tableaux des charges / Notas relativas a los graficos de carga	7
42-45		Ausrüstung / Equipment / Equipement / Equipo	
46		Symbolerklärung / Symbols / Glossaire des symboles / Glosario de simbolos	



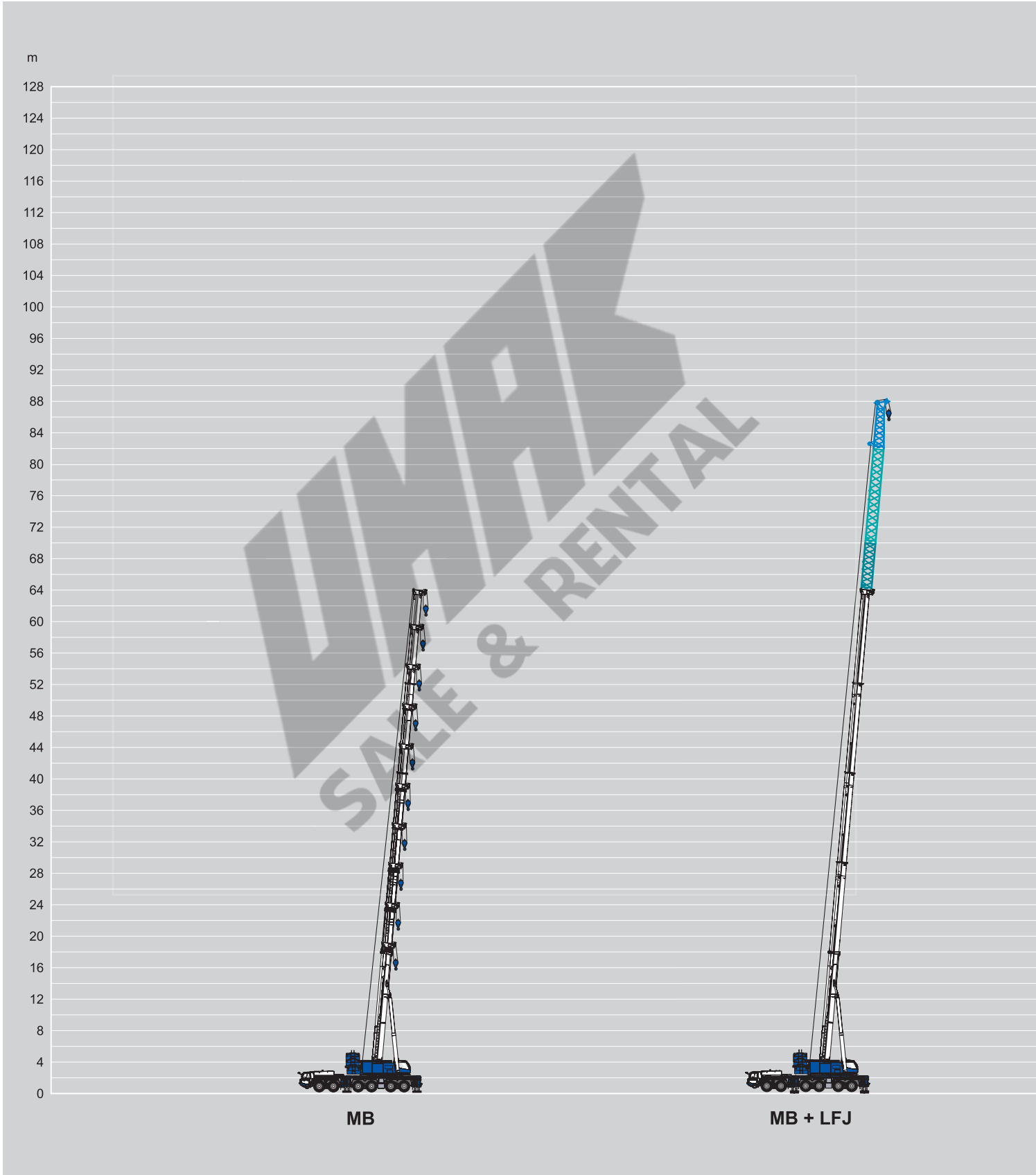



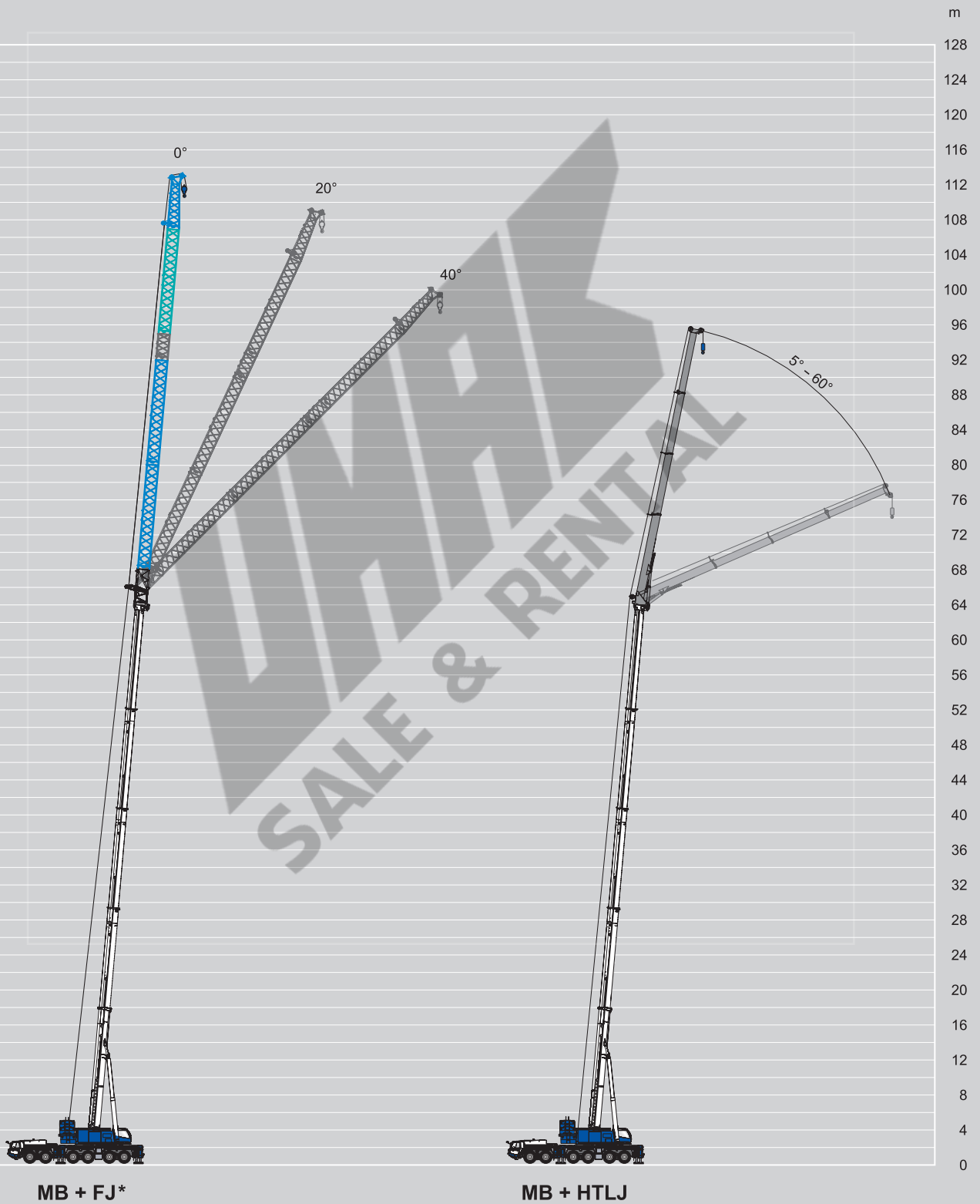







Hubhöhen + Anbauteile
 Lifting heights + Attachment
 Hauteurs de levage + Attachement
 Alturas de elevación + Elemento de construcción



DIN/ISO/EN



Übersicht
 General survey
 Vue d'ensemble
 Sistema de vigilancia

	
6 m	
12 m	
18 m	
24 m	
	
Heavy Duty 2.0 m + 3.5 m (5.5 m)	
	
2.0 m + 11.5 m (13.5 m)	
2.0 m + 17.5 m (19.5 m)	
2.0 m + 23.5 m (25.5 m)	
2.0 m + 29.5 m (31.5 m)	
2.0 m + 35.5 m (37.5 m)	
2.0 m + 41.5 m (43.5 m)	
2.0 m + 47.5 m (49.5 m)	

Übersicht + Teile
 General survey + parts
 Vue d'ensemble + parts
 Sistema de vigilancia + parte

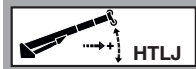

2.3 m + 10.3 m
 (12.6 m)

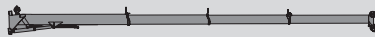

2.3 m + 31 m
 (33.3 m)

Abmessungen + Gewichte / Dimensions + Weights / Dimensiones + Poids / Dimensiones + Pesos

3



Zwischenstück / Intermediate section / Section intermédiaire / Tramo intermedio 12 m

Länge / Length / Longueur / Largo : 12.162 m
 Breite / Width / Large / Ancho : 1.836 m
 Höhe / Height / Hauteur / Altura : 1.520 m
 Gewicht / Weight / Poid / Peso : 2047 kg

4



Reduzierstück / Reducer / Adaptateur / Adaptador conico de "LJ a FJ" 3 m

Länge / Length / Longueur / Largo : 3.162 m
 Breite / Width / Large / Ancho : 1.836 m
 Höhe / Height / Hauteur / Altura : 1.506 m
 Gewicht / Weight / Poid / Peso : 710 kg

6



Zwischenstück / Intermediate section / Section intermédiaire / Tramo intermedio 6 m

Länge / Length / Longueur / Largo : 6.162 m
 Breite / Width / Large / Ancho : 1.081 m
 Höhe / Height / Hauteur / Altura : 1.475 m
 Gewicht / Weight / Poid / Peso : 900 kg

7



Zwischenstück / Intermediate section / Section intermédiaire / Tramo intermedio 12 m

Länge / Length / Longueur / Largo : 12.162 m
 Breite / Width / Large / Ancho : 1.081 m
 Höhe / Height / Hauteur / Altura : 1.475 m
 Gewicht / Weight / Poid / Peso : 1550 kg

8



Auslegerspitze / Jib top section / Flèche / Punta de plumin 6 m

Länge / Length / Longueur / Largo : 6.515 m
 Breite / Width / Large / Ancho : 1.128 m
 Höhe / Height / Hauteur / Altura : 2.021 m
 Gewicht / Weight / Poid / Peso : 1386 kg

9



Abwinkelstück / Adapter fixed jib / Adaptateur de flèche / Adaptador de pluma 4.15 m

Länge / Length / Longueur / Largo : 4.312 m
 Breite / Width / Large / Ancho : 2.045 m
 Höhe / Height / Hauteur / Altura : 2.798 m
 Gewicht / Weight / Poid / Peso : 2164 kg

10



Schwerlastkopf / Heavy duty top section / Tête d'élément pour levage lourd / Cabezal 1 m

Länge / Length / Longueur / Largo : 1.473 m
 Breite / Width / Large / Ancho : 1.747 m
 Höhe / Height / Hauteur / Altura : 2.595 m
 Gewicht / Weight / Poid / Peso : 579 kg



HTLJ

Länge / Length / Longueur / Largo : 12.712 m
 Breite / Width / Large / Ancho : 1.568 m
 Höhe / Height / Hauteur / Altura : 2.362 m
 Gewicht / Weight / Poid / Peso : 10150 kg

Gegengewichtvarianten
 Counterweight versions
 Variations des contrepoids
 Variaciones de contrapeso

Gesamtgewicht Total weight Poids total Peso total	Gegengewicht / Counterweight / Contrepoids / Contrapeso					
	7.5 t	9 t	8.5 t	11 t	11 t	10 t
	①	②	③	④	⑤	⑥
98 t	1	1	1	2	1	4
78 t	1	1	1	2	1	2
58 t	1	1	1	2	1	
47 t	1	1	1	2		
36 t	1	1	1		1	
25 t	1	1	1			
16.5 t	1	1				
7.5 t	1					

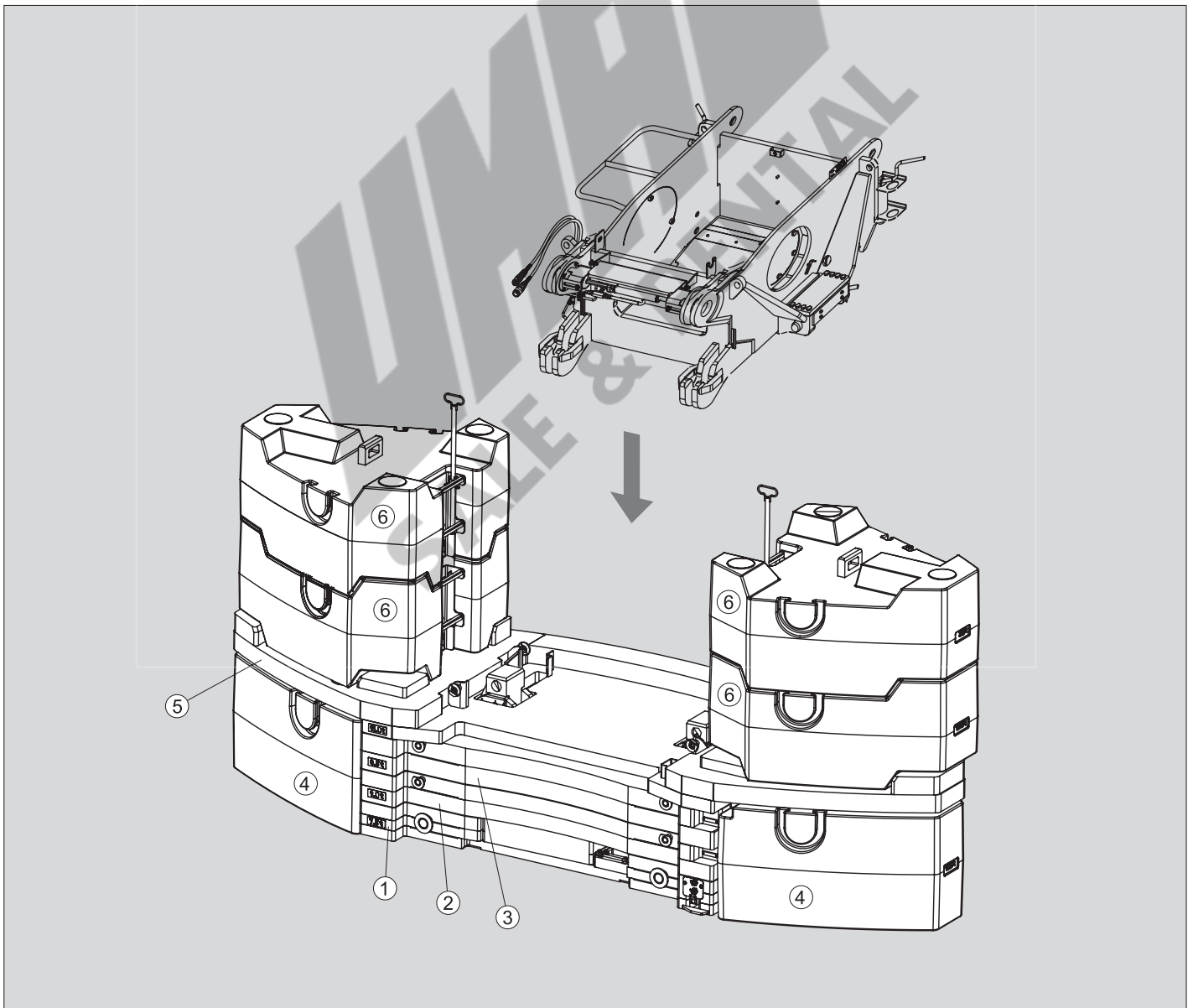
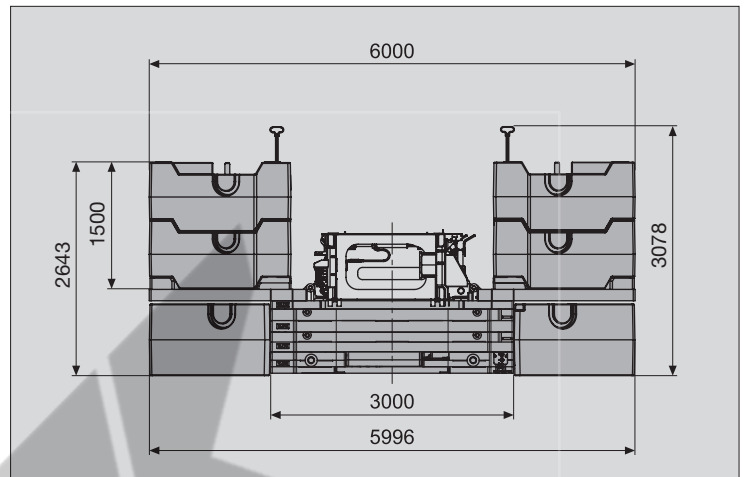

Gegengewichtvarianten
Counterweight versions
Variations des contrepoids
Variaciones de contrapeso

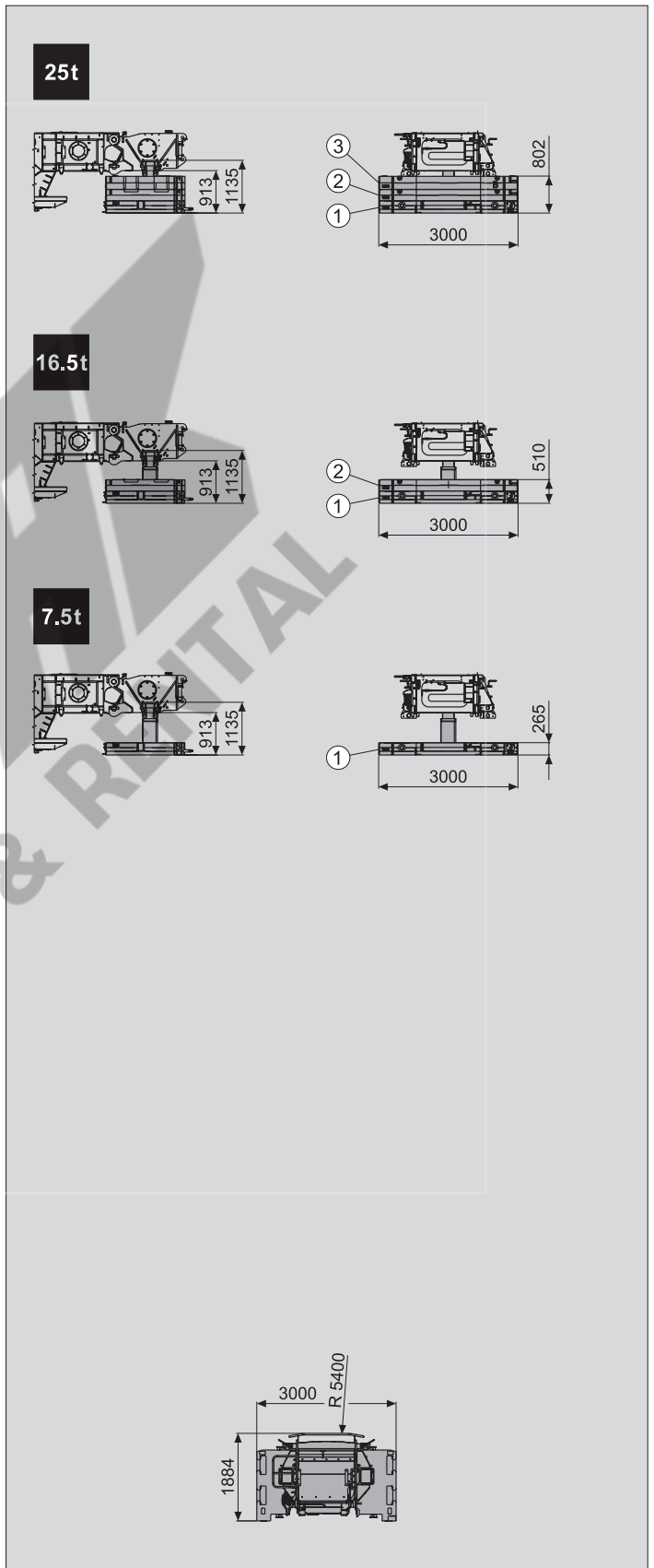
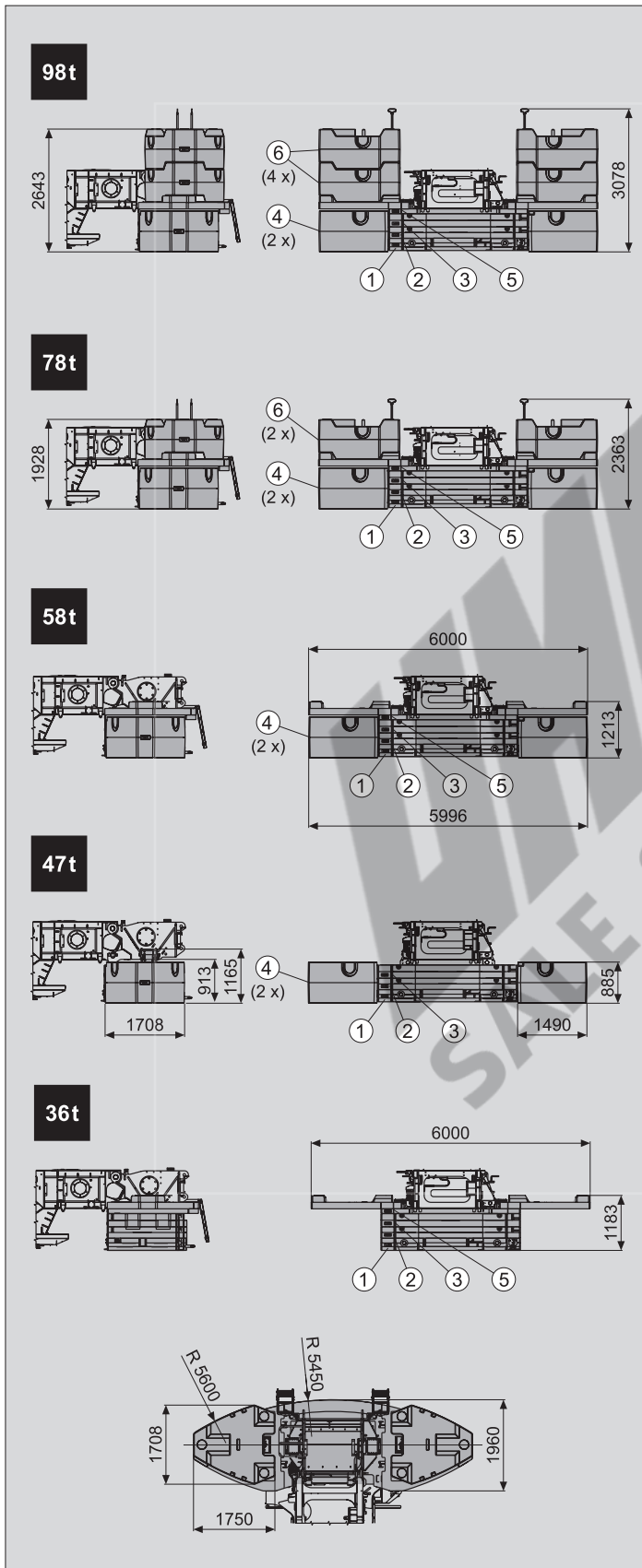

Maße (mm)
 Dimensions (mm)
 Dimensiones (mm)

445/95 R 25
 (16.00 R 25)

DIN/ISO/EN

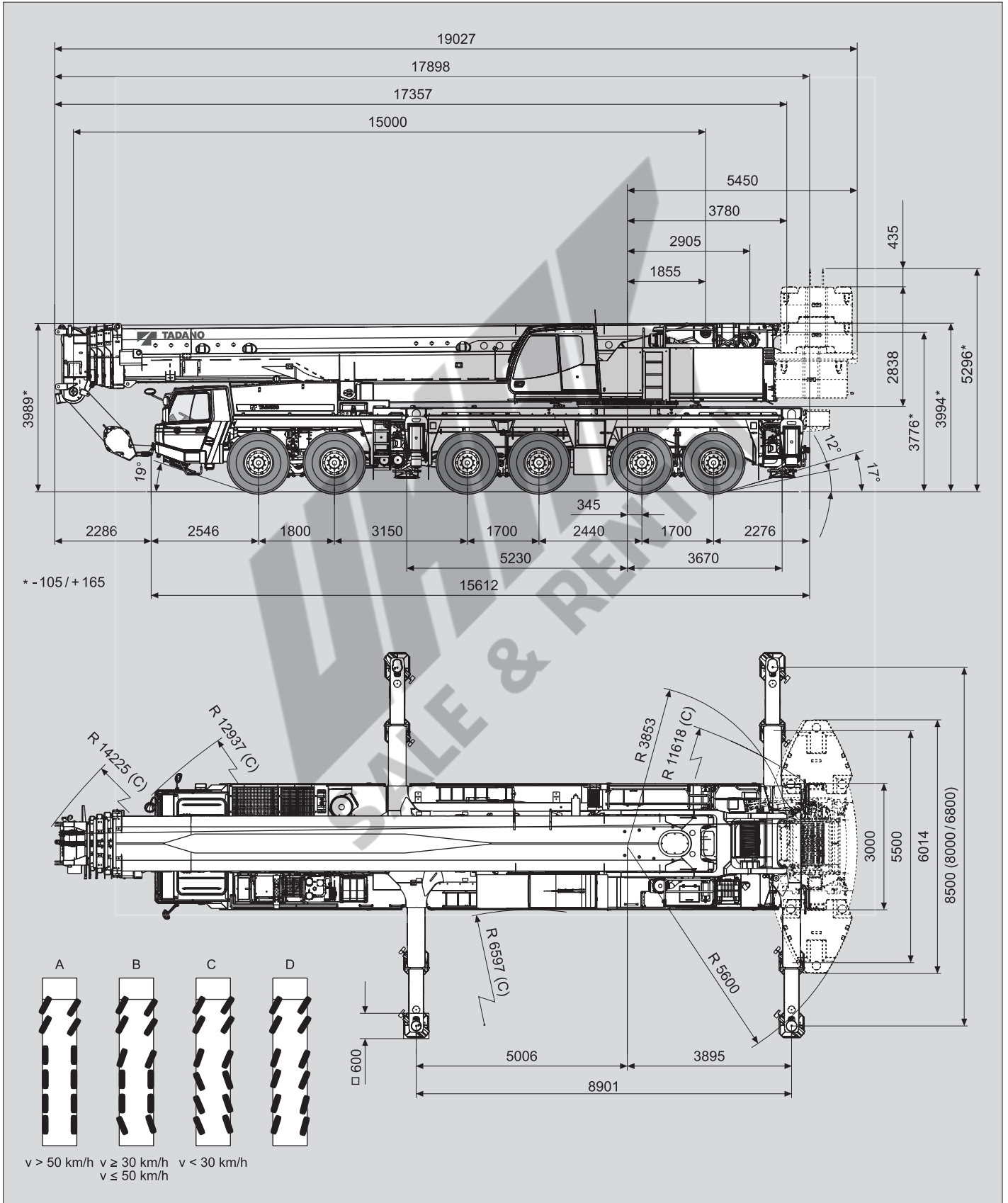

Gewichte / Geschwindigkeiten
Weights / Working speeds
Poids / Vitesses
Pesos / Velocidades de trabajo

	Achse / Axle Essieu / Eje	1	2	3	4	5	6	Gesamtgewicht / Total weight Poids total / Peso total
	(t)	12	12	12	12	12	12	12

* Incl. 12,5 t Hakengeschrir, Werkzeugkasten, Antrieb 12 x 8 x 12, Bereifung 445/95 R 25 (16.00 R 25).
* Incl. 12.5 t swivel hook, toolbox, drive 12 x 8 x 12, tyres 445/95 R 25 (16.00 R 25).
* Incl. 12,5 t elingues, boîte à outils, entraînement 12 x 8 x 12, pneus 445/95 R 25 (16.00 R 25).
* Incl. 12,5 t gancho de bola, caja de herramientas, tracción 12 x 8 x 12, neumáticos 445/95 R 25 (16.00 R 25).

	Traglast / Lifting capacity / Force de levage / Capacidad de elevación	Rollen / Sheaves Pulies / Poleas	Stränge / Parts of line Brins / Ramales de cable	Gewicht / Weight Poid / Peso
	221.6 t (Typ / Type / Typo 250)*	9	19	2700 kg
177.1 t (Typ / Type / Typo 200)*	7	15	2300 kg	
131.4 t (Typ / Type / Typo 160)*	5	11	1800 kg	
84.6 t (Typ / Type / Typo 100)*	3	7	1550 kg	
36.7 t (Typ / Type / Typo 40)	1	3	600 kg/950 kg	
12.3 t (Typ / Type / Typo 12.5)	-	1	410 kg	

* Doppelhaken
* Rams horn
* Moufle avec crochet marin
* Gancho doble



	1	2	3	4	5	6	7	8	9	10	11	12	R1	R2				
																385/95 R 25 (14.00 R 25)		
km/h	3.6	4.6	5.9	7.6	9.6	12.3	16.3	20.9	27.0	34.6	43.9	56.3	3.9	4.9	54.9%			
km/h	445/95 R 25 (16.00 R 25)			3.9	5.0	6.4	8.3	10.5	13.4	17.7	22.7	29.4	37.7	47.7	61.2	4.2	5.4	53.5%*
				6.0	7.7	9.9	12.7	16.1	20.6	27.3	35.0	45.2	58.0	73.5	85.0	6.5	8.3	49.2%

* Mit Geländeübersetzung * Avec mode tout terrain
* Off road range * Con transmisión todo terreno

V+	Stufenlos Infinitely variable Progressivement variable Infinitamente variable	Seil Rope Câble Cable	Seilzug Single line pull Effort au brin simple Trio por ramal
	0 - 125 m/min für einfachen Strang single line au brin simple ramal simple	23 mm / 350 m	120 kN
	0 - 125 m/min für einfachen Strang single line au brin simple ramal simple	23 mm / 580 m	120 kN
	0 - 1.1 min ⁻¹		
	- 0.8° - + 83.5° ca. 50 s approx. 50 s env. 50 s aproximadamente 50 s		
	15.0 m - 60.0 m ca. 500 s approx. 500 s env. 500 s aproximadamente 500 s		

Hubhöhen
Lifting heights
Hauteurs de levage
Alturas de elevación

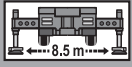
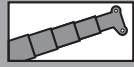

98t

DIN/ISO/EN

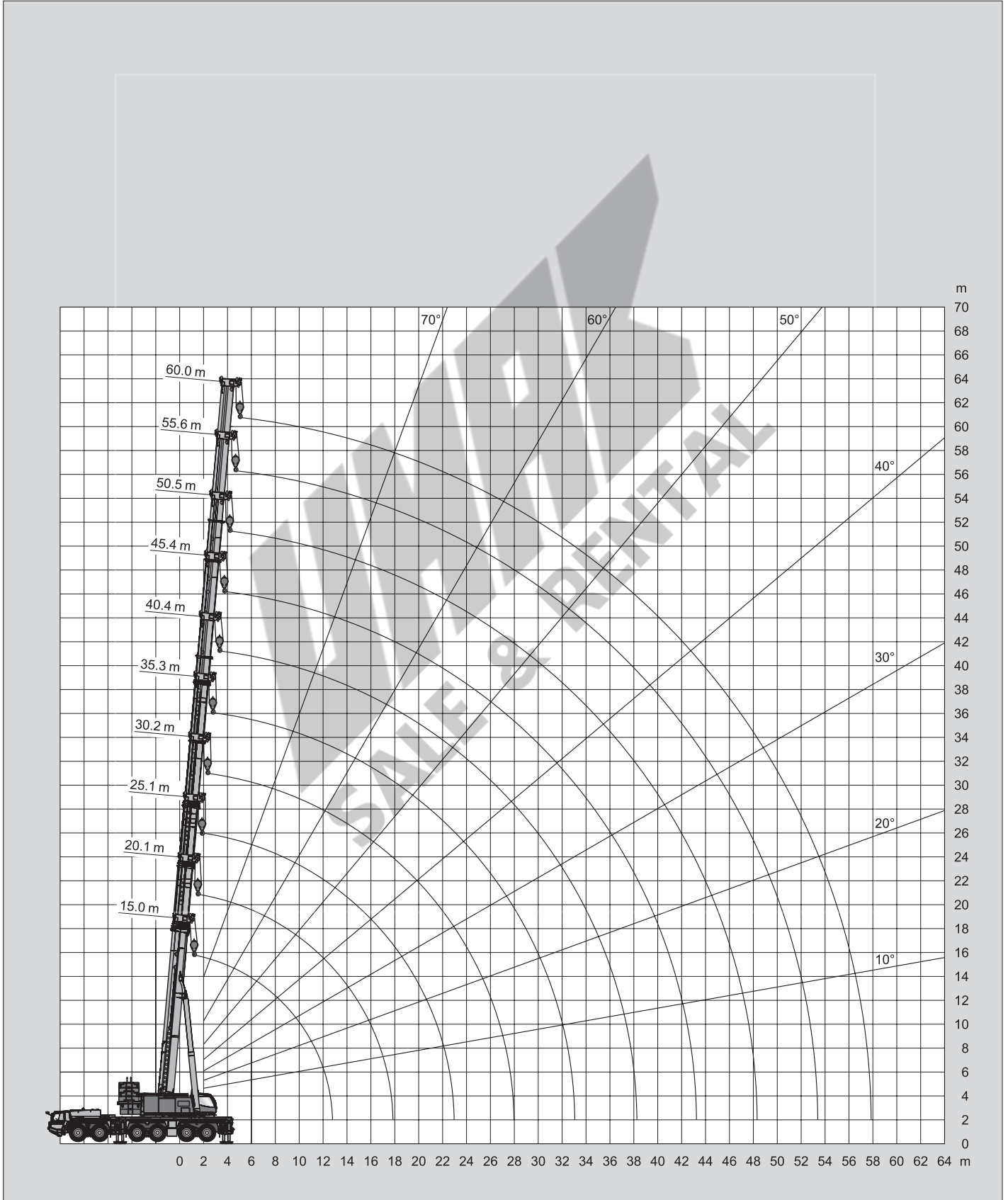

Tragfähigkeiten
Lifting capacities
Capacités de levage
Capacidades de elevación

DIN/ISO/EN

 m	15.0 m	20.1 m	25.1 m	30.2 m	35.3 m	40.4 m	45.4 m	50.5 m	55.6 m	60.0 m
2.7	400.0*									
3.0	200.0	170.0	162.0							
3.5	200.0	170.0	162.0							
4.0	200.0	170.0	162.0	139.0						
4.5	192.9	170.0	162.0	139.0						
5.0	180.6	170.0	162.0	139.0	123.4					
6.0	158.0	157.6	157.0	139.0	113.8	84.2				
7.0	139.9	139.6	138.9	127.9	103.1	84.2	71.6			
8.0	125.2	124.8	124.1	118.2	94.2	84.2	71.6	54.3		
9.0	112.9	112.5	112.5	109.8	86.7	79.5	69.5	54.3	45.0	
10.0	102.6	102.2	102.2	102.4	81.2	73.6	65.7	54.3	45.0	38.0
11.0	93.5	93.1	93.0	93.2	76.5	68.5	62.4	54.0	45.0	38.0
12.0	83.4	85.1	85.0	85.2	72.3	64.0	59.3	50.9	44.6	38.0
14.0		71.9	72.8	72.0	65.3	56.5	52.7	45.6	40.4	38.0
16.0		59.2	60.1	59.2	59.5	50.5	47.1	41.3	36.9	35.0
18.0		41.9	50.8	50.0	51.1	45.6	42.6	37.6	33.9	32.3
20.0			43.8	44.8	43.9	41.6	38.8	34.6	31.4	29.6
22.0			38.3	39.3	38.4	37.7	35.5	32.0	29.0	27.2
24.0				34.8	33.8	33.0	32.7	29.7	26.9	25.1
26.0				31.0	29.9	29.2	29.6	27.7	25.1	23.3
28.0				24.4	26.8	25.9	26.8	26.0	23.5	21.7
30.0					24.1	23.2	24.0	24.0	22.1	20.3
32.0					21.8	20.8	21.7	21.7	20.8	19.0
34.0						18.8	19.6	19.6	19.6	17.9
36.0						17.1	17.9	17.8	18.2	16.7
38.0						15.0	16.3	16.4	16.6	15.6
40.0							14.9	15.6	15.2	14.5
42.0							13.7	14.7	13.9	13.6
44.0								13.5	12.8	12.7
46.0								12.6	11.8	11.8
48.0								11.5	10.9	10.9
50.0									10.0	10.0
52.0									9.3	9.3
54.0										8.6
56.0										7.9
58.0										6.2

* mit Zusatzausstattung
* with additional equipment
* avec équipement supplémentaire
* con equipo adicional

SALE & RENTAL

MB

Tragfähigkeiten
Lifting capacities
Capacités de levage
Capacidades de elevación

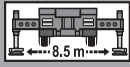
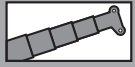
78t
DIN/ISO/EN

 m	15.0 m	20.1 m	25.1 m	30.2 m	35.3 m	40.4 m	45.4 m	50.5 m	55.6 m	60.0 m
3.0	200.0	170.0	162.0							
3.5	200.0	170.0	162.0							
4.0	200.0	170.0	162.0	139.0						
4.5	189.0	170.0	162.0	139.0						
5.0	175.6	170.0	162.0	139.0	123.4					
6.0	153.2	152.8	152.2	139.0	113.8	84.2				
7.0	135.3	134.9	134.3	127.9	103.1	84.2	71.6			
8.0	120.8	120.4	120.3	118.2	94.2	84.2	71.6	54.3		
9.0	107.9	107.5	107.5	107.7	86.7	79.5	69.5	54.3	45.0	
10.0	97.2	96.7	96.7	95.7	81.2	73.6	65.7	54.3	45.0	38.0
11.0	88.2	87.7	87.6	84.7	76.5	68.5	62.4	54.0	45.0	38.0
12.0	77.4	76.8	77.8	75.8	72.3	64.0	59.3	50.9	44.6	38.0
14.0		60.8	61.7	60.9	61.5	56.5	52.7	45.6	40.4	38.0
16.0		51.7	50.7	51.9	51.1	49.4	47.1	41.3	36.9	35.0
18.0		41.9	44.1	43.8	43.0	42.3	41.8	37.6	33.9	32.3
20.0			37.9	37.5	36.6	35.8	36.3	34.6	31.4	29.6
22.0			33.0	32.5	31.5	30.8	31.7	31.8	29.0	27.2
24.0				28.5	27.5	26.7	27.6	27.7	26.9	25.1
26.0				25.3	24.2	23.4	24.3	24.3	24.7	23.3
28.0				22.7	21.5	20.6	21.5	22.0	21.9	21.7
30.0					19.2	18.3	19.2	20.3	19.6	19.7
32.0					17.3	17.3	17.6	18.2	17.5	17.6
34.0						16.4	16.6	16.5	15.7	15.9
36.0						15.6	15.4	14.9	14.2	14.3
38.0						14.7	14.0	13.5	12.8	12.9
40.0							12.8	12.3	11.6	11.7
42.0							11.8	11.2	10.5	10.6
44.0								10.3	9.5	9.6
46.0								9.4	8.6	8.7
48.0								8.7	7.8	7.9
50.0									7.1	7.2
52.0									6.5	6.5
54.0										5.9
56.0										5.4
58.0										4.9

Tragfähigkeiten
Lifting capacities
Capacités de levage
Capacidades de elevación





58t

DIN/ISO/EN

 m	15.0 m	20.1 m	25.1 m	30.2 m	35.3 m	40.4 m	45.4 m	50.5 m	55.6 m	60.0 m
3.0	200.0	170.0	162.0							
3.5	200.0	170.0	162.0							
4.0	198.5	170.0	162.0	139.0						
4.5	183.3	170.0	162.0	139.0						
5.0	170.0	169.6	162.0	139.0	123.4					
6.0	147.8	147.4	146.8	139.0	113.8	84.2				
7.0	129.3	128.9	128.9	123.7	103.1	84.2	71.6			
8.0	113.9	113.4	110.3	103.7	94.2	84.2	71.6	54.3		
9.0	101.2	100.0	95.3	88.8	85.9	79.5	69.5	54.3	45.0	
10.0	85.0	84.4	82.8	77.4	75.3	70.8	65.7	54.3	45.0	38.0
11.0	72.9	72.4	72.9	71.1	66.9	63.0	61.0	54.0	45.0	38.0
12.0	63.6	65.1	64.1	63.7	59.9	56.5	55.0	50.9	44.6	38.0
14.0		51.5	52.1	51.9	49.3	46.5	46.0	44.5	40.4	38.0
16.0		41.8	42.4	42.1	41.1	38.9	38.8	37.6	36.9	35.0
18.0		35.0	35.3	35.0	34.0	33.0	33.1	32.5	31.7	31.0
20.0			29.9	29.5	28.5	27.7	28.6	29.2	27.5	27.0
22.0			26.0	25.2	24.2	24.1	25.4	25.6	24.1	23.7
24.0				23.0	20.8	22.3	22.6	22.1	21.3	20.9
26.0				20.4	18.4	20.2	19.7	19.3	18.6	18.6
28.0				18.3	17.2	17.9	17.4	16.9	16.2	16.4
30.0					15.9	15.9	15.4	15.0	14.2	14.4
32.0					14.4	14.2	13.7	13.3	12.5	12.7
34.0						12.8	12.3	11.8	11.1	11.2
36.0						11.6	11.0	10.5	9.8	9.9
38.0						10.6	9.9	9.4	8.7	8.8
40.0							8.9	8.4	7.7	7.8
42.0							8.1	7.5	6.8	6.9
44.0								6.8	6.0	6.1
46.0								6.1	5.3	5.4
48.0								5.5	4.7	4.7
50.0									4.1	4.1
52.0									3.6	3.6
54.0										3.1
56.0										2.7
58.0										2.3

MB



SALE & RENTAL

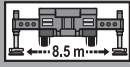
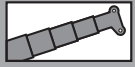

Tragfähigkeiten
Lifting capacities
Capacités de levage
Capacidades de elevación

47t
DIN/ISO/EN

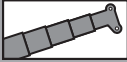
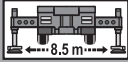
 m	15.0 m	20.1 m	25.1 m	30.2 m	35.3 m	40.4 m	45.4 m	50.5 m	55.6 m	60.0 m
3.0	200.0	170.0	162.0							
3.5	200.0	170.0	162.0							
4.0	195.3	170.0	162.0	139.0						
4.5	180.1	170.0	162.0	139.0						
5.0	166.8	166.4	162.0	139.0	123.4					
6.0	144.2	143.8	143.0	137.2	113.8	84.2				
7.0	125.0	124.6	119.6	111.3	103.1	84.2	71.6			
8.0	109.8	106.5	100.6	93.1	89.4	83.3	71.6	54.3		
9.0	89.9	89.3	85.6	81.5	77.1	72.1	69.3	54.3	45.0	
10.0	75.3	74.8	74.2	72.1	67.5	63.3	61.1	54.3	45.0	38.0
11.0	64.5	66.0	65.0	63.8	59.8	56.2	54.5	52.9	45.0	38.0
12.0	56.2	57.6	58.2	57.0	53.5	50.2	49.4	47.5	44.6	38.0
14.0		45.4	46.0	45.8	43.4	40.7	40.4	39.0	38.2	37.2
16.0		37.0	37.6	37.3	36.1	33.8	33.8	34.1	32.1	31.4
18.0		30.6	31.1	30.6	29.5	28.7	30.6	29.2	27.4	26.8
20.0			26.2	26.9	24.6	26.2	26.5	25.3	23.7	23.2
22.0			22.5	23.0	21.5	23.1	22.6	22.1	20.6	20.2
24.0				20.0	19.8	19.9	19.4	19.0	18.1	17.8
26.0				17.5	17.3	17.4	16.9	16.4	15.7	15.7
28.0				15.7	15.2	15.3	14.8	14.3	13.6	13.8
30.0					13.5	13.5	13.0	12.5	11.8	12.0
32.0					12.1	12.0	11.5	11.0	10.3	10.4
34.0						10.7	10.2	9.7	9.0	9.1
36.0						9.6	9.0	8.6	7.8	8.0
38.0						8.7	8.1	7.6	6.8	6.9
40.0							7.2	6.7	5.9	6.0
42.0							6.5	5.9	5.2	5.2
44.0								5.2	4.5	4.5
46.0								4.6	3.8	3.9
48.0								4.1	3.3	3.3
50.0									2.7	2.8
52.0									2.3	2.3
54.0										1.9
56.0										1.5

Tragfähigkeiten
Lifting capacities
Capacités de levage
Capacidades de elevación

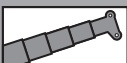
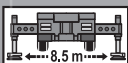
   36t DIN/ISO/EN										
→ m	15.0 m	20.1 m	25.1 m	30.2 m	35.3 m	40.4 m	45.4 m	50.5 m	55.6 m	60.0 m
3.0	200.0	170.0	162.0							
3.5	200.0	170.0	162.0							
4.0	192.1	170.0	162.0	139.0						
4.5	177.0	170.0	162.0	139.0						
5.0	163.7	163.4	162.0	139.0	123.4					
6.0	139.8	139.3	131.2	120.1	109.8	84.2				
7.0	120.9	113.6	106.2	97.2	92.5	84.2	71.6			
8.0	97.9	92.8	87.9	84.2	78.0	72.4	69.2	54.3		
9.0	79.4	78.2	74.6	72.1	67.1	62.5	60.6	54.3	45.0	
10.0	66.4	68.0	66.5	62.8	58.3	54.3	52.9	50.5	45.0	38.0
11.0	56.7	58.2	58.3	55.0	51.1	47.6	46.8	45.9	43.5	38.0
12.0	49.2	50.7	51.3	48.7	45.3	42.2	41.7	41.5	39.0	37.8
14.0		39.2	39.9	39.2	36.4	35.2	35.9	34.1	31.9	31.1
16.0		31.0	31.8	32.5	30.0	31.6	30.0	28.5	26.7	26.0
18.0		25.5	26.0	26.8	25.8	26.9	25.5	24.2	22.6	22.1
20.0			21.7	22.4	22.3	22.6	22.0	20.8	19.3	18.9
22.0			18.5	19.1	18.9	19.1	18.6	18.0	16.7	16.3
24.0				16.4	16.2	16.4	15.9	15.4	14.4	14.2
26.0				14.3	14.1	14.2	13.7	13.2	12.5	12.3
28.0				12.7	12.3	12.3	11.8	11.4	10.7	10.8
30.0					10.8	10.8	10.3	9.8	9.1	9.2
32.0					9.6	9.5	9.0	8.5	7.8	7.9
34.0						8.4	7.8	7.3	6.6	6.7
36.0						7.4	6.8	6.4	5.6	5.7
38.0						6.7	6.0	5.5	4.8	4.9
40.0							5.2	4.7	4.0	4.1
42.0							4.6	4.0	3.3	3.4
44.0								3.4	2.7	2.8
46.0								2.9	2.1	2.2
48.0								2.5	1.6	1.7

   25t DIN/ISO/EN										
→ m	15.0 m	20.1 m	25.1 m	30.2 m	35.3 m	40.4 m	45.4 m	50.5 m	55.6 m	60.0 m
3.0	200.0	170.0	162.0							
3.5	200.0	170.0	162.0							
4.0	188.2	170.0	162.0	139.0						
4.5	173.1	170.0	162.0	139.0						
5.0	158.5	158.1	144.9	131.4	117.8					
6.0	134.4	122.1	112.2	103.7	95.1	84.2				
7.0	105.9	95.4	89.4	84.9	77.7	71.4	68.0			
8.0	83.8	80.6	76.0	70.6	64.6	59.3	57.2	54.0		
9.0	67.8	67.3	63.7	59.4	54.6	50.3	50.6	48.1	44.7	
10.0	56.4	57.0	54.4	51.0	47.0	45.4	44.8	42.1	39.2	37.8
11.0	47.3	49.1	47.2	44.4	40.9	42.1	39.5	37.3	34.7	33.5
12.0	39.8	41.6	41.8	40.8	36.5	37.4	35.2	33.2	30.9	30.0
14.0		31.2	32.2	32.8	31.4	30.3	28.6	27.0	25.0	24.3
16.0		24.4	25.2	26.1	25.9	25.1	23.7	22.3	20.6	20.1
18.0		19.8	20.4	21.2	21.1	21.2	19.9	18.7	17.2	16.8
20.0			16.8	17.5	17.4	17.6	16.9	15.9	14.5	14.2
22.0			14.1	14.7	14.5	14.7	14.2	13.5	12.2	12.0
24.0				12.5	12.3	12.4	11.9	11.5	10.4	10.2
26.0				10.7	10.5	10.6	10.1	9.6	8.8	8.6
28.0				9.4	9.0	9.1	8.5	8.1	7.4	7.3
30.0					7.8	7.8	7.2	6.8	6.1	6.2
32.0					6.8	6.7	6.1	5.7	5.0	5.1
34.0						5.8	5.2	4.7	4.0	4.1
36.0						5.0	4.4	3.9	3.2	3.3
38.0						4.4	3.7	3.2	2.4	2.5
40.0							3.0	2.5	1.8	1.8
42.0							2.5	1.9		

Tragfähigkeiten
Lifting capacities
Capacités de levage
Capacidades de elevación





16.5t

DIN/ISO/EN

 m	15.0 m	20.1 m	25.1 m	30.2 m	35.3 m	40.4 m	45.4 m	50.5 m	55.6 m	60.0 m
3.0	200.0	170.0	162.0							
3.5	200.0	170.0	162.0							
4.0	185.2	170.0	162.0	139.0						
4.5	168.8	168.4	148.7	132.5						
5.0	154.1	143.9	128.5	114.2	104.3					
6.0	118.9	105.0	97.5	90.5	81.7	73.4				
7.0	90.9	84.9	78.8	72.0	64.9	58.9	57.4			
8.0	71.8	67.8	63.5	58.7	53.3	52.9	49.6	46.1		
9.0	58.2	55.7	53.2	51.1	45.7	45.6	42.5	39.6	36.6	
10.0	47.0	46.9	45.2	43.8	41.4	39.5	36.9	34.5	31.9	30.7
11.0	38.5	40.2	39.1	38.1	36.2	34.6	32.4	30.4	28.0	27.1
12.0	32.2	34.0	34.2	33.6	31.9	30.7	28.7	26.9	24.8	24.0
14.0		25.1	26.1	26.7	25.5	24.6	23.0	21.6	19.8	19.2
16.0		19.4	20.2	21.1	20.9	20.2	18.8	17.6	16.0	15.6
18.0		15.5	16.1	16.9	16.8	16.8	15.6	14.5	13.0	12.7
20.0			13.0	13.7	13.6	13.9	13.0	12.0	10.6	10.3
22.0			10.8	11.4	11.2	11.4	10.9	9.9	8.6	8.4
24.0				9.4	9.2	9.4	8.9	8.2	7.0	6.8
26.0				7.9	7.6	7.7	7.2	6.7	5.6	5.5
28.0				6.8	6.3	6.4	5.9	5.4	4.5	4.4
30.0					5.3	5.3	4.7	4.3	3.5	3.4
32.0					4.4	4.3	3.8	3.3	2.6	2.5
34.0						3.5	3.0	2.5		
36.0						2.9	2.3	1.8		
38.0						2.4	1.7			







7.5t

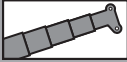
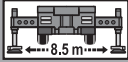

DIN/ISO/EN

 m	15.0 m	20.1 m	25.1 m	30.2 m	35.3 m	40.4 m	45.4 m	50.5 m	55.6 m	60.0 m
3.0	200.0	170.0	162.0							
3.5	199.3	170.0	162.0							
4.0	180.9	170.0	162.0	139.0						
4.5	163.8	146.8	128.4	115.3						
5.0	141.1	120.3	108.6	98.5	86.6					
6.0	99.1	90.8	82.0	73.4	65.0	63.3				
7.0	73.1	68.0	63.3	59.5	54.8	51.2	46.9			
8.0	56.4	53.6	50.8	48.4	45.1	42.5	39.2	36.2		
9.0	45.2	43.7	42.0	40.5	38.0	36.0	33.3	30.9	28.1	
10.0	36.4	36.5	35.4	34.5	32.5	31.0	28.7	26.6	24.3	23.3
11.0	29.4	31.1	30.4	29.8	28.2	27.0	25.0	23.2	20.9	20.0
12.0	24.3	26.1	26.4	26.1	24.7	23.7	21.8	20.1	18.0	17.4
14.0		18.9	19.9	20.1	19.0	18.3	16.8	15.4	13.7	13.2
16.0		13.9	14.8	15.7	15.0	14.4	13.2	12.0	10.5	10.2
18.0		10.5	11.2	12.0	11.9	11.6	10.5	9.4	8.1	7.8
20.0			8.6	9.4	9.2	9.3	8.3	7.4	6.1	5.9
22.0			6.7	7.3	7.2	7.4	6.6	5.8	4.6	4.4
24.0				5.8	5.6	5.8	5.3	4.4	3.3	
26.0				4.6	4.4	4.5	3.9	3.3		
28.0				3.8	3.3	3.4	2.9			
30.0					2.5	2.5	2.0			
32.0					1.9	1.8				

Tragfähigkeiten
Lifting capacities
Capacités de levage
Capacidades de elevación

   0t DIN/ISO/EN										
→ m	15.0 m	20.1 m	25.1 m	30.2 m	35.3 m	40.4 m	45.4 m	50.5 m	55.6 m	60.0 m
3.0	200.0	170.0	162.0							
3.5	195.4	170.0	162.0							
4.0	175.4	170.0	162.0	139.0						
4.5	150.6	124.7	112.7	98.4						
5.0	119.8	106.1	93.8	81.2	69.8					
6.0	80.8	73.4	66.9	61.7	55.9	51.4				
7.0	58.0	54.4	51.0	48.0	44.2	41.1	37.4			
8.0	44.2	42.5	40.5	38.8	36.1	33.9	31.0	28.0		
9.0	35.0	34.4	33.2	32.2	30.0	28.1	25.5	23.1	20.4	
10.0	28.0	28.0	27.3	26.7	24.8	23.5	21.3	19.3	17.0	16.2
11.0	22.1	22.9	22.6	22.4	20.9	19.9	18.0	16.3	14.2	13.6
12.0	17.3	19.0	19.0	19.0	17.8	17.0	15.4	13.8	12.0	11.5
14.0		12.9	13.9	14.1	13.3	12.7	11.4	10.1	8.6	8.2
16.0		8.9	9.8	10.7	10.1	9.6	8.5	7.5	6.1	5.8
18.0		6.3	7.0	7.9	7.7	7.4	6.4	5.4		
20.0			5.0	5.8	5.7	5.6	4.7	3.8		
22.0			3.6	4.2	4.0	4.2	3.4			
24.0				3.0	2.8	2.9				
26.0				2.0	1.8	1.9				

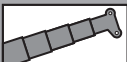
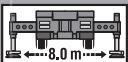
MB

   0t DIN/ISO/EN										
→ m	15.0 m	20.1 m	25.1 m	30.2 m	35.3 m	40.4 m	45.4 m	50.5 m	55.6 m	60.0 m
3.0	200.0	170.0	162.0							
3.5	190.9	170.0	162.0							
4.0	171.1	170.0	162.0	139.0						
4.5	136.7	114.0	97.8	83.7						
5.0	104.2	91.0	80.1	72.6	64.7					
6.0	69.0	63.4	58.3	54.1	49.2	45.4				
7.0	50.2	47.6	44.8	42.5	39.2	36.5	33.3			
8.0	38.6	37.4	35.9	34.5	32.1	30.2	27.6	25.2		
9.0	30.7	30.3	29.5	28.7	26.9	25.4	23.3	21.3	19.0	
10.0	24.5	25.1	24.7		22.8	21.7	19.9	18.2	16.2	15.5
11.0	19.4	21.1	21.0	20.8	19.6	18.7	17.1	15.6	13.8	13.3
12.0	15.7	17.6	18.0	18.0	17.0	16.2	14.8	13.5	11.8	11.4
14.0		12.2	13.2	13.8	13.0	12.5	11.3	10.1	8.6	8.2
16.0		8.7	9.6	10.4	10.1	9.6	8.5	7.5	6.1	5.8
18.0		6.3	7.0	7.8	7.7	7.4	6.4	5.4		
20.0			5.0	5.7	5.6	5.6	4.7	3.8		
22.0			3.6	4.2	4.0	4.2	3.4			
24.0				3.0	2.8	2.9				
26.0				2.0	1.8	1.9				

Hubhöhen
Lifting heights
Hauteurs de levage
Alturas de elevación

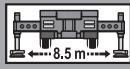
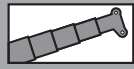

98t

DIN/ISO/EN

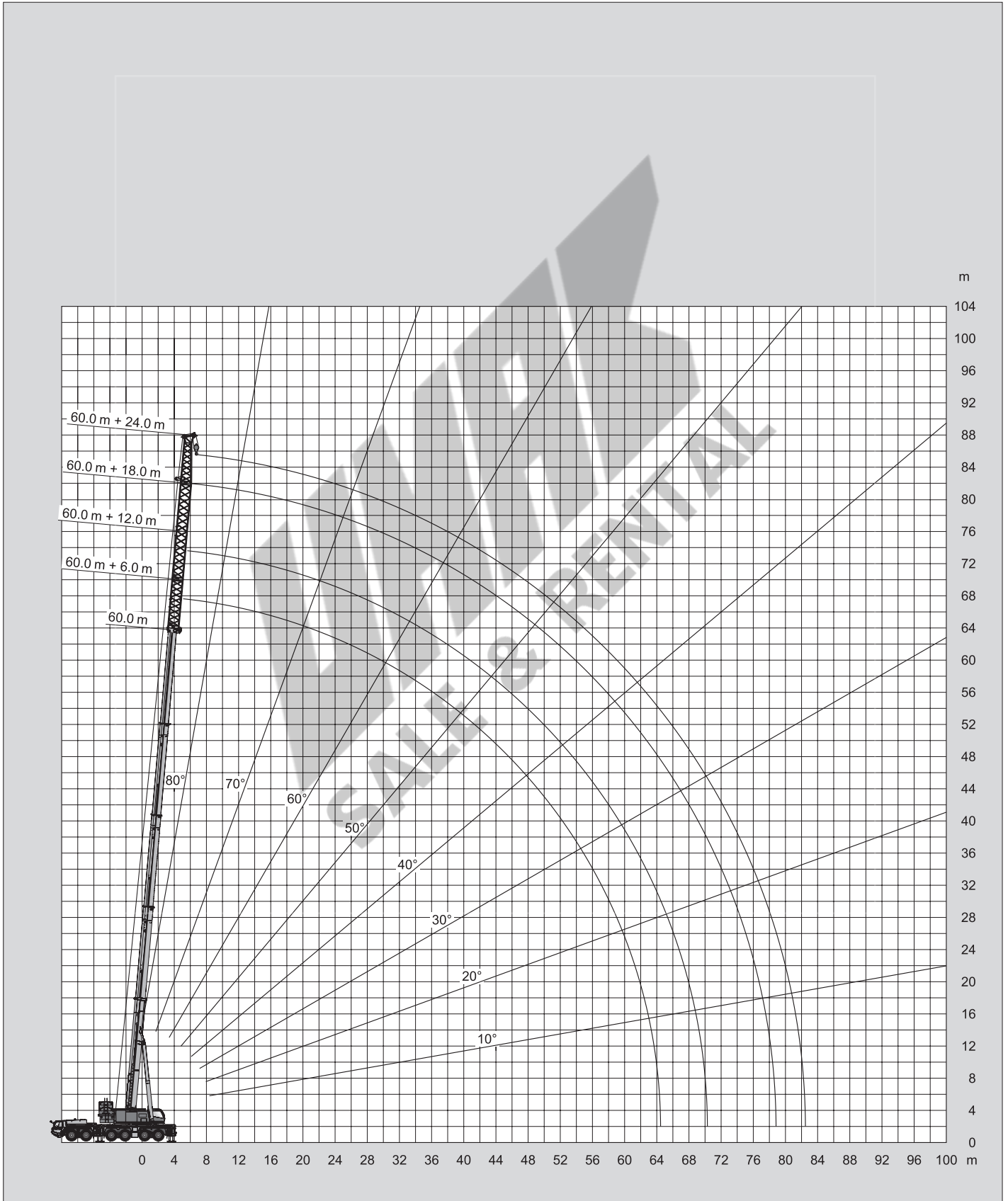

Tragfähigkeiten
Lifting capacities
Capacités de levage
Capacidades de elevación





98t

DIN/ISO/EN

m	LFJ 6.0 m					LFJ 12.0 m					LFJ 18.0 m					LFJ 24.0 m					
	40.4 m	45.4 m	50.5 m	55.6 m	60.0 m	40.4 m	45.4 m	50.5 m	55.6 m	60.0 m	40.4 m	45.4 m	50.5 m	55.6 m	60.0 m	40.4 m	45.4 m	50.5 m	55.6 m	60.0 m	
7.0	54.2																				
8.0	50.7	43.2																			
9.0	47.6	40.8	32.2			43.5															
10.0	44.9	38.6	30.5	26.8		41.0	34.9	27.5			34.3										
11.0	42.5	36.8	29.0	25.5	24.2	38.8	33.1	26.1			32.8	30.2				24.6					
12.0	40.4	35.1	27.6	24.2	23.0	36.8	31.5	24.8	22.1		31.4	28.7	22.9			23.8	22.6				
14.0	36.8	32.2	25.2	22.1	21.0	33.4	28.8	22.6	20.3	19.1	29.0	26.2	20.9	18.2	17.3	22.2	21.4	18.8			
16.0	33.8	29.7	23.3	20.4	19.3	30.6	26.5	20.8	18.7	17.6	26.9	24.1	19.2	16.8	16.0	20.8	20.2	17.3	15.2	13.9	
18.0	31.3	27.5	21.7	18.9	18.0	28.2	24.6	19.3	17.3	16.3	25.0	22.3	17.8	15.7	14.9	19.5	19.1	16.1	14.1	13.4	
20.0	29.2	25.5	20.3	17.7	16.8	26.2	23.0	18.0	16.1	15.2	23.4	20.8	16.5	14.6	13.9	18.2	18.1	15.0	13.1	12.5	
22.0	27.4	23.9	19.1	16.6	15.7	24.5	21.6	16.8	15.0	14.2	22.0	19.5	15.4	13.7	13.1	17.1	17.0	14.1	12.3	11.7	
24.0	25.8	22.4	18.0	15.6	14.8	23.0	20.4	15.9	14.1	13.3	20.7	18.3	14.5	12.9	12.3	16.1	16.1	13.2	11.6	11.0	
26.0	24.4	21.2	17.1	14.8	14.0	21.7	19.3	15.0	13.3	12.6	19.6	17.3	13.6	12.2	11.5	15.2	15.3	12.4	10.9	10.4	
28.0	22.9	20.0	16.2	14.0	13.3	20.5	18.2	14.2	12.6	11.9	18.6	16.4	12.9	11.5	10.9	14.4	14.5	11.7	10.3	9.9	
30.0	21.5	19.0	15.5	13.4	12.6	19.5	17.3	13.5	12.0	11.3	17.6	15.6	12.2	10.9	10.3	13.6	13.8	11.0	9.8	9.4	
32.0	20.3	18.2	14.8	12.8	12.1	18.6	16.4	12.9	11.4	10.7	16.8	14.8	11.6	10.3	9.8	13.0	13.2	10.5	9.3	8.9	
34.0	18.5	17.3	14.3	12.2	11.5	17.7	15.6	12.3	10.9	10.2	16.1	14.2	11.1	9.8	9.3	12.3	12.6	9.9	8.9	8.4	
36.0	16.8	16.6	13.7	11.7	11.1	17.0	14.9	11.8	10.4	9.8	15.4	13.6	10.6	9.4	8.9	11.8	12.0	9.5	8.4	8.0	
38.0	15.2	15.5	13.2	11.3	10.6	15.7	14.3	11.3	9.9	9.4	14.7	13.0	10.1	8.9	8.5	11.3	11.5	9.0	8.0	7.6	
40.0	13.8	14.1	12.8	10.9	10.2	14.3	13.7	10.9	9.5	9.0	14.1	12.5	9.7	8.6	8.1	10.8	11.1	8.6	7.7	7.3	
42.0	12.6	12.9	12.4	10.5	9.9	13.1	13.2	10.5	9.2	8.6	13.6	12.0	9.3	8.2	7.8	10.4	10.7	8.3	7.3	6.9	
44.0	10.9	11.8	12.1	10.2	9.5	11.9	12.1	10.2	8.8	8.3	12.4	11.5	9.0	7.9	7.5	10.0	10.3	7.9	7.0	6.6	
46.0		10.8	11.3	9.8	9.2	10.9	11.1	9.8	8.5	8.0	11.4	11.1	8.7	7.6	7.2	9.6	9.9	7.6	6.7	6.4	
48.0		9.9	10.4	9.6	9.0	10.0	10.2	9.6	8.3	7.7	10.5	10.5	8.4	7.3	6.9	9.3	9.6	7.3	6.5	6.0	
50.0			9.6	9.3	8.7	8.7	9.3	9.3	8.0	7.5	9.6	9.7	8.1	7.1	6.7	9.0	9.3	7.1	6.2	5.7	
54.0			7.8	8.5	8.3		7.9	8.2	7.5	7.0	8.2	8.2	7.6	6.6	6.0	8.3	8.3	6.6	5.8	5.0	
58.0				7.2	7.2			7.0	7.2	6.3		6.9	7.2	6.2	5.4	7.0	7.0	6.2	5.4	4.4	
62.0					6.1					6.2			6.1	5.9	4.8	5.1	5.9	5.9	5.0	3.9	
66.0										5.1				5.0	4.4		5.0	5.1	4.7	3.5	
70.0														4.6	4.0			4.3	4.3	3.1	
74.0															3.7				3.7	2.8	
78.0																				2.5	

MB + LFJ

SALE & RENTAL

Tragfähigkeiten
Lifting capacities
Capacités de levage
Capacidades de elevación



DIN/ISO/EN

m	LFJ 6.0 m					LFJ 12.0 m					LFJ 18.0 m					LFJ 24.0 m					
	40.4 m	45.4 m	50.5 m	55.6 m	60.0 m	40.4 m	45.4 m	50.5 m	55.6 m	60.0 m	40.4 m	45.4 m	50.5 m	55.6 m	60.0 m	40.4 m	45.4 m	50.5 m	55.6 m	60.0 m	
7.0	54.2																				
8.0	50.7	43.2																			
9.0	47.6	40.8	32.2			43.5															
10.0	44.9	38.6	30.5	26.8		41.0	34.9	27.5			34.3										
11.0	42.5	36.8	29.0	25.5	24.2	38.8	33.1	26.1			32.8	30.2				24.6					
12.0	40.4	35.1	27.6	24.2	23.0	36.8	31.5	24.8	22.1		31.4	28.7	22.9			23.8	22.6				
14.0	36.8	32.2	25.2	22.1	21.0	33.4	28.8	22.6	20.3	19.1	29.0	26.2	20.9	18.2	17.3	22.2	21.4	18.8			
16.0	33.8	29.7	23.3	20.4	19.3	30.6	26.5	20.8	18.7	17.6	26.9	24.1	19.2	16.8	16.0	20.8	20.2	17.3	15.2	13.9	
18.0	31.3	27.5	21.7	18.9	18.0	28.2	24.6	19.3	17.3	16.3	25.0	22.3	17.8	15.7	14.9	19.5	19.1	16.1	14.1	13.4	
20.0	27.1	25.5	20.3	17.7	16.8	26.2	23.0	18.0	16.1	15.2	23.4	20.8	16.5	14.6	13.9	18.2	18.1	15.0	13.1	12.5	
22.0	23.3	23.3	19.1	16.6	15.7	23.5	21.6	16.8	15.0	14.2	22.0	19.5	15.4	13.7	13.1	17.1	17.0	14.1	12.3	11.7	
24.0	19.8	20.3	18.0	15.6	14.8	20.5	20.3	15.9	14.1	13.3	20.7	18.3	14.5	12.9	12.3	16.1	16.1	13.2	11.6	11.0	
26.0	17.0	17.5	17.1	14.8	14.0	17.7	18.0	15.0	13.3	12.6	18.3	17.3	13.6	12.2	11.5	15.2	15.3	12.4	10.9	10.4	
28.0	14.7	15.1	15.8	14.0	13.3	15.4	15.7	14.2	12.6	11.9	16.0	16.0	12.9	11.5	10.9	14.4	14.5	11.7	10.3	9.9	
30.0	12.7	13.1	13.8	13.4	12.6	13.4	13.7	13.5	12.0	11.3	14.0	14.1	12.2	10.9	10.3	13.6	13.8	11.0	9.8	9.4	
32.0	11.1	11.5	12.1	12.6	12.1	11.7	12.0	12.4	11.4	10.7	12.3	12.4	11.6	10.3	9.8	12.7	12.6	10.5	9.3	8.9	
34.0	9.6	10.0	10.7	11.1	11.2	10.2	10.5	10.9	10.9	10.2	10.8	10.9	11.1	9.8	9.3	11.2	11.1	9.9	8.9	8.4	
36.0	8.4	8.7	9.4	9.8	9.9	8.9	9.2	9.6	10.1	9.8	9.5	9.6	10.0	9.4	8.9	9.8	9.8	9.5	8.4	8.0	
38.0	7.3	7.6	8.3	8.7	8.8	7.8	8.1	8.5	8.9	8.8	8.4	8.5	8.9	8.9	8.5	8.7	8.7	8.9	8.0	7.6	
40.0	6.3	6.6	7.3	7.7	7.7	6.8	7.1	7.4	7.9	7.8	7.4	7.4	7.9	8.1	7.9	7.7	7.7	7.9	7.7	7.3	
42.0	5.5	5.8	6.4	6.8	6.8	5.9	6.2	6.5	7.0	6.9	6.5	6.5	6.9	7.2	7.0	6.8	6.8	7.0	7.1	6.9	
44.0	4.8	5.0	5.6	6.0	6.0	5.2	5.4	5.7	6.2	6.1	5.7	6.1	6.4	6.2	5.9	5.9	6.1	6.3	6.1		
46.0		4.3	4.9	5.3	5.3	4.5	4.7	5.0	5.4	5.3	5.0	5.0	5.4	5.6	5.5	5.2	5.2	5.4	5.6	5.4	
48.0		3.7	4.2	4.6	4.6	3.9	4.0	4.4	4.8	4.7	4.3	4.4	4.7	5.0	4.8	4.5	4.5	4.7	4.9	4.7	
50.0			3.6	4.0	4.0	3.3	3.4	3.8	4.2	4.1	3.7	3.8	4.1	4.4	4.2	3.9	3.9	4.1	4.3	4.1	
54.0			2.7	3.0	3.0		2.4	2.7	3.1	3.0	2.7	2.7	3.1	3.3	3.1	2.9	2.8	3.0	3.2	3.0	
58.0				2.2	2.1			1.9	2.2	2.1		1.9	2.2	2.4	2.2	2.0	2.0	2.1	2.3	2.1	
62.0									1.5					1.6	1.5					1.5	

SALE & RENTAL



WIPAK
SALE & RENTAL

Hubhöhen
Lifting heights
Hauteurs de levage
Alturas de elevación

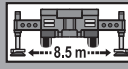
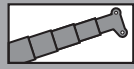

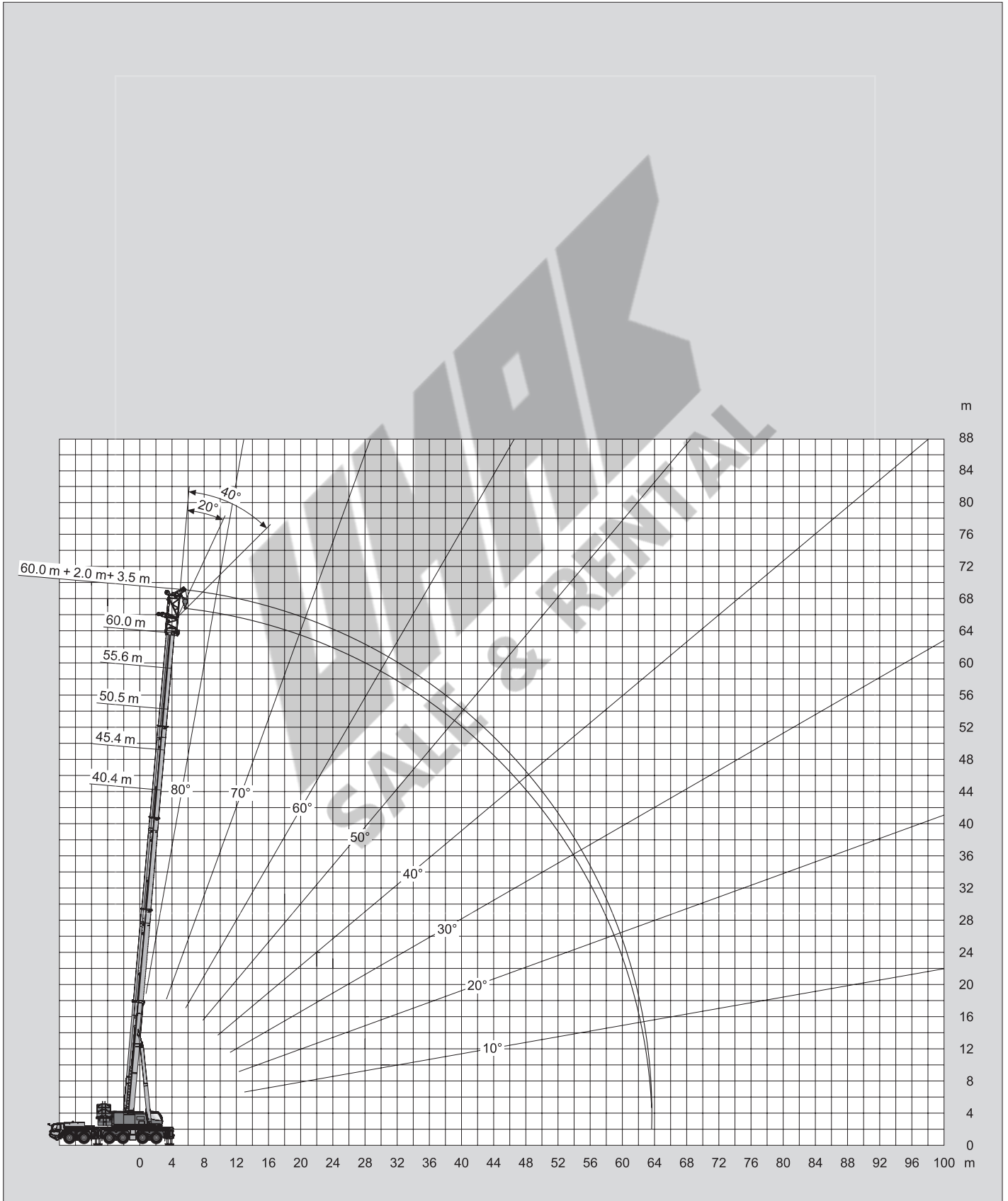

98 t

DIN/ISO/EN



Tragfähigkeiten
Lifting capacities
Capacités de levage
Capacidades de elevación

																DIN/ISO/EN		
	40.4 m + 2.0 m + 3.5 m			45.4 m + 2.0 m + 3.5 m			50.5 m + 2.0 m + 3.5 m			55.6 m + 2.0 m + 3.5 m			60.0 m + 2.0 m + 3.5 m					
	0°	20°	40°	0°	20°	40°	0°	20°	40°	0°	20°	40°	0°	20°	40°			
8.0	48.2																	
9.0	45.4	42.9		38.4														
10.0	42.9	40.7	39.3	36.5	34.3		28.7											
11.0	40.7	38.8	37.5	34.8	32.8	31.4	27.3	25.7			24.1							
12.0	38.7	37.0	35.8	33.2	31.4	30.2	26.0	24.6	23.7	23.0	21.7			21.8				
14.0	35.3	33.9	33.0	30.6	29.1	28.1	23.8	22.7	21.9	21.0	20.2	19.4	19.9	19.1	18.4			
16.0	32.5	31.3	30.6	28.4	27.1	26.3	22.0	21.1	20.5	19.4	18.7	18.2	18.4	17.7	17.3			
18.0	30.2	29.2	28.6	26.3	25.4	24.7	20.5	19.7	19.2	18.0	17.4	17.0	17.0	16.5	16.1			
20.0	28.1	27.3	26.8	24.5	23.9	23.3	19.2	18.5	18.0	16.8	16.3	15.9	15.9	15.4	15.1			
22.0	26.4	25.7	25.3	22.9	22.3	22.0	18.0	17.4	17.1	15.7	15.3	15.0	14.9	14.5	14.2			
24.0	24.9	24.2	23.9	21.5	21.0	20.8	17.0	16.5	16.2	14.8	14.4	14.2	14.0	13.6	13.4			
26.0	23.5	23.0	22.7	20.3	19.9	19.7	16.2	15.7	15.4	14.0	13.6	13.4	13.2	12.9	12.7			
28.0	22.1	21.9	21.7	19.2	18.8	18.7	15.4	14.9	14.7	13.3	13.0	12.8	12.5	12.2	12.1			
30.0	20.7	20.7	20.7	18.2	17.9	17.8	14.7	14.3	14.1	12.6	12.3	12.2	11.9	11.7	11.5			
32.0	19.4	19.5	19.4	17.3	17.1	17.0	14.0	13.7	13.5	12.0	11.8	11.6	11.3	11.1	11.0			
34.0	17.3	17.5	17.5	16.6	16.3	16.2	13.5	13.2	13.0	11.5	11.3	11.2	10.8	10.6	10.5			
36.0	15.5	15.6	15.7	15.8	15.7	15.6	13.0	12.7	12.6	11.0	10.8	10.7	10.4	10.2	10.1			
38.0	13.9	14.0		14.2	14.4	14.4	12.5	12.3	12.2	10.6	10.4	10.3	9.9	9.8	9.7			
40.0	12.5	12.6		12.8	12.9	12.9	12.1	11.9	11.8	10.2	10.0	10.0	9.6	9.4	9.3			
42.0	11.3	11.3		11.5	11.6		11.7	11.5	11.5	9.8	9.7	9.6	9.2	9.1	9.0			
44.0	5.5			10.4	10.5		11.0	11.1	11.1	9.5	9.4	9.3	8.9	8.7	8.7			
46.0				9.4	9.5		10.0	10.0		9.2	9.1	9.1	8.6	8.5	8.4			
48.0				8.5			9.0	9.1		8.9	8.8	8.8	8.3	8.2	8.2			
50.0							8.2	8.2		8.7	8.6		8.1	8.0	7.9			
54.0							4.1			7.2	7.2		7.1	7.2				
58.0										5.9			5.9	5.9				
62.0													4.8	4.8				

MB
+ Heavy Duty

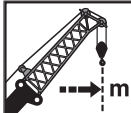
																DIN/ISO/EN		
	40.4 m + 2.0 m + 3.5 m			45.4 m + 2.0 m + 3.5 m			50.5 m + 2.0 m + 3.5 m			55.6 m + 2.0 m + 3.5 m			60.0 m + 2.0 m + 3.5 m					
	0°	20°	40°	0°	20°	40°	0°	20°	40°	0°	20°	40°	0°	20°	40°			
8.0	48.2																	
9.0	45.4	42.9		38.4														
10.0	42.9	40.7	39.3	36.5	34.3		28.7											
11.0	40.7	38.8	37.5	34.8	32.8	31.4	27.3	25.7			24.1							
12.0	38.7	37.0	35.8	33.2	31.4	30.2	26.0	24.6	23.7	23.0	21.7			21.8				
14.0	35.3	33.9	33.0	30.6	29.1	28.1	23.8	22.7	21.9	21.0	20.2	19.4	19.9	19.1	18.4			
16.0	32.5	31.3	30.6	28.4	27.1	26.3	22.0	21.1	20.5	19.4	18.7	18.2	18.4	17.7	17.3			
18.0	30.2	29.2	28.6	26.3	25.4	24.7	20.5	19.7	19.2	18.0	17.4	17.0	17.0	16.5	16.1			
20.0	26.0	26.6	26.8	24.5	23.9	23.3	19.2	18.5	18.0	16.8	16.3	15.9	15.9	15.4	15.1			
22.0	22.2	22.7	23.1	22.1	22.3	22.0	18.0	17.4	17.1	15.7	15.3	15.0	14.9	14.5	14.2			
24.0	18.7	19.2	19.4	19.1	19.5	19.8	17.0	16.5	16.2	14.8	14.4	14.2	14.0	13.6	13.4			
26.0	15.9	16.3	16.5	16.2	16.6	16.9	16.2	15.7	15.4	14.0	13.6	13.4	13.2	12.9	12.7			
28.0	13.5	13.8	14.0	13.9	14.2	14.4	14.5	14.9	14.7	13.3	13.0	12.8	12.5	12.2	12.1			
30.0	11.5	11.8	11.9	11.9	12.2	12.3	12.5	12.9	13.0	12.6	12.3	12.2	11.9	11.7	11.5			
32.0	9.8	10.1	10.2	10.2	10.4	10.6	10.8	11.1	11.3	11.4	11.7	11.6	11.3	11.1	11.0			
34.0	8.4	8.6	8.6	8.7	8.9	9.0	9.3	9.6	9.7	9.9	10.2	10.3	10.0	10.3	10.4			
36.0	7.1	7.3	7.3	7.4	7.6	7.7	8.1	8.3	8.4	8.6	8.9	9.0	8.7	8.9	9.1			
38.0	6.0	6.1		6.3	6.5	6.5	6.9	7.1	7.2	7.5	7.7	7.8	7.5	7.8	7.9			
40.0	5.0	5.1		5.3	5.4	5.4	5.9	6.1	6.1	6.5	6.6	6.7	6.5	6.7	6.8			
42.0	4.2	4.2		4.4	4.5		5.0	5.2	5.2	5.6	5.7	5.8	5.6	5.8	5.9			
44.0	3.5			3.6	3.7		4.2	4.3	4.3	4.7	4.9	4.9	4.8	4.9	5.0			
46.0				3.0	3.0		3.5	3.6		4.0	4.1	4.2	4.1	4.2	4.2			
48.0				2.3			2.9	2.9		3.4	3.5	3.5	3.4	3.5	3.5			
50.0							2.3	2.3		2.8	2.8		2.8	2.9	2.9			
54.0										1.7	1.8		1.7	1.8				

Hubhöhen
Lifting heights
Hauteurs de levage
Alturas de elevación







DIN/ISO/EN

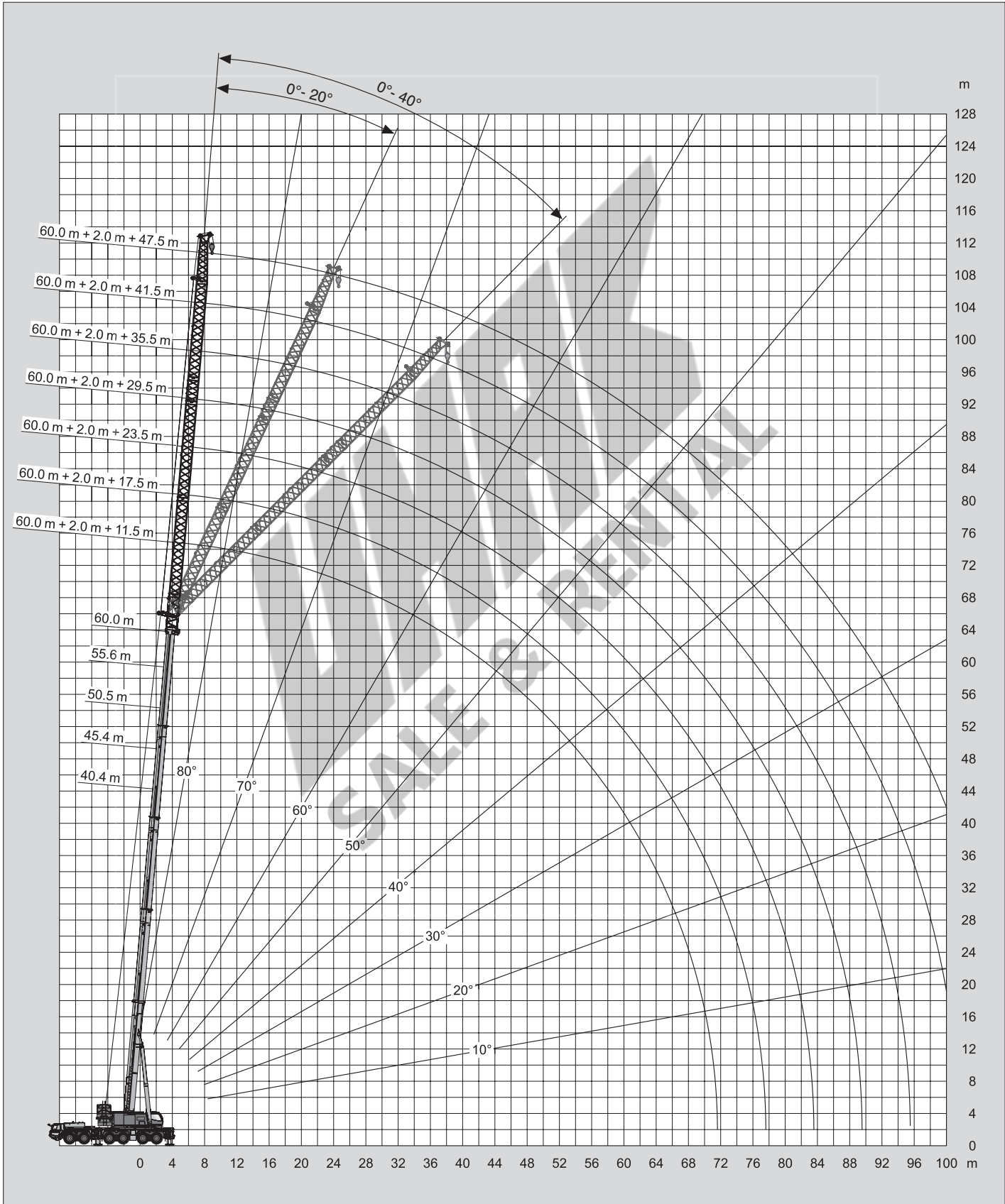

Tragfähigkeiten
Lifting capacities
Capacités de levage
Capacidades de elevación









98t

DIN/ISO/EN

 m	40.4 m + 2.0 m + 11.5 m			45.4 m + 2.0 m + 11.5 m			50.5 m + 2.0 m + 11.5 m			55.6 m + 2.0 m + 11.5 m			60.0 m + 2.0 m + 11.5 m		
	0°	20°	40°	0°	20°	40°	0°	20°	40°	0°	20°	40°	0°	20°	40°
9.0	41.7														
10.0	39.2			33.2											
11.0	37.1			31.5			24.8								
12.0	35.1			29.9			23.5			20.8					
14.0	31.9	27.6		27.3	23.7		21.4			19.0			18.0		
16.0	29.1	26.1	22.7	25.1	22.1		19.6	16.9		17.6	15.0		16.6		
18.0	26.9	24.5	21.8	23.3	20.6	19.0	18.1	16.0	14.1	16.2	14.1		15.3	13.4	
20.0	24.9	22.9	21.0	21.7	19.4	17.9	16.9	15.2	13.5	15.0	13.3	12.1	14.2	12.6	
22.0	23.3	21.5	20.3	20.3	18.3	17.0	15.8	14.3	13.0	14.0	12.6	11.5	13.2	12.0	11.0
24.0	21.8	20.2	19.2	19.1	17.3	16.2	14.8	13.5	12.5	13.1	12.0	11.0	12.4	11.4	10.5
26.0	20.5	19.1	18.3	18.1	16.5	15.5	13.9	12.8	12.0	12.4	11.4	10.6	11.6	10.8	10.0
28.0	19.4	18.1	17.4	17.1	15.7	14.8	13.2	12.1	11.5	11.7	10.9	10.1	11.0	10.3	9.6
30.0	18.4	17.3	16.6	16.2	15.0	14.2	12.5	11.6	11.0	11.0	10.3	9.8	10.4	9.7	9.3
32.0	17.4	16.5	15.9	15.4	14.4	13.7	11.9	11.0	10.5	10.5	9.8	9.4	9.8	9.3	8.9
34.0	16.6	15.8	15.3	14.6	13.8	13.2	11.3	10.6	10.1	9.9	9.4	9.0	9.4	8.8	8.5
36.0	15.9	15.1	14.7	13.9	13.3	12.7	10.8	10.1	9.7	9.5	9.0	8.6	8.9	8.4	8.2
38.0	14.7	14.5	14.1	13.3	12.8	12.3	10.4	9.7	9.4	9.0	8.6	8.3	8.5	8.1	7.8
40.0	13.3	13.9	13.7	12.7	12.3	12.0	10.0	9.4	9.0	8.7	8.2	8.0	8.1	7.7	7.5
42.0	12.0	12.5	12.8	12.2	11.8	11.6	9.6	9.0	8.7	8.3	7.9	7.7	7.8	7.4	7.2
44.0	10.9	11.3	11.5	11.0	11.4	11.2	9.2	8.7	8.5	8.0	7.6	7.4	7.5	7.1	7.0
46.0	9.9	10.2		10.0	10.5	10.7	8.9	8.4	8.2	7.7	7.3	7.1	7.2	6.9	6.7
48.0	8.9	9.2		9.1	9.5	9.6	8.6	8.2	8.0	7.4	7.1	6.9	6.9	6.6	6.5
50.0	8.1	8.3		8.2	8.6		8.4	8.0	7.8	7.1	6.8	6.7	6.5	6.3	6.3
54.0				6.7	6.9		7.0	7.3		6.7	6.4	6.3	5.7	5.6	5.6
58.0							5.8	6.0		6.1	6.1	6.0	5.1	5.0	5.1
62.0							2.0			5.0	5.2		4.5	4.5	4.6
66.0										4.0	4.1		3.9	4.0	
70.0													3.1	3.1	

MB + FJ



58t

DIN/ISO/EN

 m	40.4 m + 2.0 m + 11.5 m			45.4 m + 2.0 m + 11.5 m			50.5 m + 2.0 m + 11.5 m			55.6 m + 2.0 m + 11.5 m			60.0 m + 2.0 m + 11.5 m		
	0°	20°	40°	0°	20°	40°	0°	20°	40°	0°	20°	40°	0°	20°	40°
9.0	41.7														
10.0	39.2			33.2											
11.0	37.1			31.5			24.8								
12.0	35.1			29.9			23.5			20.8					
14.0	31.9	27.6		27.3	23.7		21.4			19.0			18.0		
16.0	29.1	26.1	22.7	25.1	22.1		19.6	16.9		17.6	15.0		16.6		
18.0	26.9	24.5	21.8	23.3	20.6	19.0	18.1	16.0	14.1	16.2	14.1		15.3	13.4	
20.0	24.9	22.9	21.0	21.7	19.4	17.9	16.9	15.2	13.5	15.0	13.3	12.1	14.2	12.6	
22.0	22.2	21.5	20.3	20.3	18.3	17.0	15.8	14.3	13.0	14.0	12.6	11.5	13.2	12.0	11.0
24.0	19.3	20.2	19.2	19.0	17.3	16.2	14.8	13.5	12.5	13.1	12.0	11.0	12.4	11.4	10.5
26.0	16.7	18.2	18.3	16.7	16.5	15.5	13.9	12.8	12.0	12.4	11.4	10.6	11.6	10.8	10.0
28.0	14.3	15.7	16.7	14.6	15.7	14.8	13.2	12.1	11.5	11.7	10.9	10.1	11.0	10.3	9.6
30.0	12.4	13.5	14.4	12.6	13.8	14.2	12.5	11.6	11.0	11.0	10.3	9.8	10.4	9.7	9.3
32.0	10.6	11.7	12.5	10.9	12.0	12.8	11.2	11.0	10.5	10.5	9.8	9.4	9.8	9.3	8.9
34.0	9.2	10.1	10.8	9.4	10.4	11.1	9.7	10.6	10.1	9.9	9.4	9.0	9.4	8.8	8.5
36.0	7.9	8.7	9.3	8.1	9.0	9.6	8.5	9.3	9.7	8.9	9.0	8.6	8.7	8.4	8.2
38.0	6.8	7.5	8.0	7.0	7.8	8.3	7.3	8.1	8.7	7.7	8.6	8.3	7.6	8.1	7.8
40.0	5.8	6.4	6.8	6.0	6.7	7.1	6.3	7.0	7.5	6.7	7.5	8.0	6.6	7.4	7.5
42.0	4.9	5.4	5.7	5.1	5.7	6.1	5.4	6.1	6.5	5.8	6.5	7.0	5.7	6.4	6.9
44.0	4.1	4.6	4.8	4.3	4.8	5.1	4.6	5.2	5.6	5.0	5.6	6.0	4.9	5.5	6.0
46.0	3.4	3.8		3.5	4.0	4.3	3.9	4.4	4.7	4.3	4.8	5.2	4.1	4.7	5.1
48.0	2.8	3.1		2.9	3.3	3.5	3.2	3.7	4.0	3.6	4.1	4.4	3.5	4.0	4.4
50.0	2.2	2.4		2.3	2.7		2.6	3.0	3.2	3.0	3.5	3.7	2.8	3.4	3.7
54.0					1.5		1.6	1.9		1.9	2.3	2.5	1.8	2.2	2.4

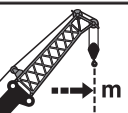
Tragfähigkeiten
Lifting capacities
Capacités de levage
Capacidades de elevación

98t

DIN/ISO/EN

	40.4 m + 2.0 m + 17.5 m			45.4 m + 2.0 m + 17.5 m			50.5 m + 2.0 m + 17.5 m			55.6 m + 2.0 m + 17.5 m			60.0 m + 2.0 m + 17.5 m		
	0°	20°	40°	0°	20°	40°	0°	20°	40°	0°	20°	40°	0°	20°	40°
10.0	32.8														
11.0	31.5			28.7											
12.0	30.3			27.3			21.5								
14.0	28.1			24.8			19.7				17.1				
16.0	26.3	20.6		22.8			18.1				15.8			14.9	
18.0	24.7	19.5		21.1	18.0		16.7	13.5			14.6			13.8	
20.0	23.0	18.6		19.6	17.0		15.5	12.8			13.6	11.4		12.9	
22.0	21.4	17.8	15.4	18.3	16.0		14.4	12.2			12.7	10.8		12.1	10.3
24.0	20.1	17.1	14.9	17.2	15.1	13.8	13.5	11.6	10.2		12.0	10.2		11.3	9.7
26.0	18.8	16.4	14.5	16.2	14.3	13.2	12.7	11.1	9.8		11.2	9.7	8.7	10.6	9.3
28.0	17.8	15.8	14.0	15.3	13.6	12.6	11.9	10.6	9.4		10.6	9.3	8.4	10.0	8.8
30.0	16.8	15.3	13.6	14.5	13.0	12.1	11.3	10.2	9.1		10.0	8.9	8.1	9.4	8.4
32.0	15.9	14.8	13.3	13.8	12.4	11.6	10.7	9.7	8.8		9.4	8.5	7.8	8.9	8.1
34.0	15.1	14.1	13.0	13.1	11.9	11.2	10.2	9.3	8.5		8.9	8.1	7.5	8.4	7.7
36.0	14.4	13.5	12.7	12.6	11.4	10.8	9.7	8.9	8.3		8.5	7.8	7.2	8.0	7.4
38.0	13.8	12.9	12.4	12.0	11.0	10.4	9.2	8.5	8.0		8.1	7.5	7.0	7.6	7.1
40.0	13.2	12.4	12.0	11.5	10.6	10.0	8.8	8.1	7.7		7.7	7.2	6.8	7.3	6.8
42.0	12.5	11.9	11.5	11.1	10.2	9.7	8.5	7.8	7.5		7.4	6.9	6.5	6.9	6.5
44.0	11.3	11.5	11.2	10.6	9.9	9.4	8.1	7.5	7.2		7.0	6.6	6.4	6.6	6.2
46.0	10.3	11.0	10.8	10.2	9.6	9.2	7.8	7.3	7.0		6.7	6.4	6.1	6.3	6.0
48.0	9.3	10.0	10.3	9.3	9.3	8.9	7.5	7.0	6.8		6.5	6.1	5.9	5.9	5.6
50.0	8.5	9.0	9.3	8.5	9.0	8.7	7.3	6.8	6.6		6.2	5.9	5.7	5.5	5.3
54.0	7.0	7.3		7.0	7.5	7.7	6.8	6.4	6.2		5.8	5.5	5.3	4.8	4.7
58.0				5.7	6.0		6.0	6.0	5.9		5.3	5.1	5.0	4.2	4.1
62.0				4.4	4.8		4.9	5.2			4.8	4.7	4.6	3.6	3.6
66.0							3.9	4.1			4.1	4.3		3.2	3.2
70.0											3.3	3.4		2.8	2.8
74.0														2.3	2.5

58t

DIN/ISO/EN

	40.4 m + 2.0 m + 17.5 m			45.4 m + 2.0 m + 17.5 m			50.5 m + 2.0 m + 17.5 m			55.6 m + 2.0 m + 17.5 m			60.0 m + 2.0 m + 17.5 m		
	0°	20°	40°	0°	20°	40°	0°	20°	40°	0°	20°	40°	0°	20°	40°
10.0	32.8														
11.0	31.5			28.7											
12.0	30.3			27.3			21.5								
14.0	28.1			24.8			19.7				17.1				
16.0	26.3	20.6		22.8			18.1				15.8			14.9	
18.0	24.7	19.5		21.1	18.0		16.7	13.5			14.6			13.8	
20.0	23.0	18.6		19.6	17.0		15.5	12.8			13.6	11.4		12.9	
22.0	21.4	17.8	15.4	18.3	16.0		14.4	12.2			12.7	10.8		12.1	10.3
24.0	19.4	17.1	14.9	17.2	15.1	13.8	13.5	11.6	10.2		12.0	10.2		11.3	9.7
26.0	17.0	16.4	14.5	16.2	14.3	13.2	12.7	11.1	9.8		11.2	9.7	8.7	10.6	9.3
28.0	15.0	15.8	14.0	14.6	13.6	12.6	11.9	10.6	9.4		10.6	9.3	8.4	10.0	8.8
30.0	12.9	14.7	13.6	12.9	13.0	12.1	11.3	10.2	9.1		10.0	8.9	8.1	9.4	8.4
32.0	11.2	12.8	13.3	11.2	12.4	11.6	10.7	9.7	8.8		9.4	8.5	7.8	8.9	8.1
34.0	9.7	11.2	12.3	9.7	11.2	11.2	10.1	9.3	8.5		8.9	8.1	7.5	8.4	7.7
36.0	8.4	9.7	10.8	8.4	9.8	10.8	8.8	8.9	8.3		8.5	7.8	7.2	8.0	7.4
38.0	7.3	8.5	9.4	7.3	8.5	9.5	7.7	8.5	8.0		7.9	7.5	7.0	7.6	7.1
40.0	6.3	7.3	8.1	6.3	7.4	8.3	6.6	7.8	7.7		6.8	7.2	6.8	6.7	6.8
42.0	5.4	6.3	7.0	5.4	6.4	7.1	5.7	6.8	7.5		5.9	6.9	6.5	5.7	6.5
44.0	4.6	5.4	6.0	4.6	5.5	6.1	4.9	5.9	6.6		5.1	6.1	6.4	4.9	6.0
46.0	3.8	4.6	5.0	3.8	4.7	5.2	4.2	5.0	5.7		4.4	5.3	5.9	4.2	5.1
48.0	3.2	3.8	4.2	3.2	3.9	4.4	3.5	4.3	4.8		3.7	4.5	5.1	3.5	4.4
50.0	2.6	3.1	3.4	2.6	3.2	3.6	2.9	3.6	4.1		3.1	3.8	4.4	2.9	3.7
54.0	1.6	1.9		1.5	2.0	2.2	1.8	2.4	2.7		2.0	2.7	3.1	1.8	2.5
58.0									1.6			1.6	1.9		1.9

Tragfähigkeiten
Lifting capacities
Capacités de levage
Capacidades de elevación

DIN/ISO/EN															
	40.4 m + 2.0 m + 23.5 m			45.4 m + 2.0 m + 23.5 m			50.5 m + 2.0 m + 23.5 m			55.6 m + 2.0 m + 23.5 m			60.0 m + 2.0 m + 23.5 m		
	0°	20°	40°	0°	20°	40°	0°	20°	40°	0°	20°	40°	0°	20°	40°
11.0	26.7														
12.0	25.7														
14.0	23.9			22.1			17.8								
16.0	22.2			20.7			16.3			14.3			13.6		
18.0	20.8			19.4			15.1			13.2			12.6		
20.0	19.6	15.3		18.1			14.1			12.3			11.7		
22.0	18.5	14.6		16.9	13.8		13.2	10.4		11.5			10.9		
24.0	17.5	13.9		15.8	13.2		12.3	9.9		10.8	8.9		10.2		
26.0	16.6	13.3	10.9	14.8	12.6		11.5	9.5		10.1	8.4		9.6	8.1	
28.0	15.8	12.8	10.6	14.0	12.2	10.5	10.9	9.0		9.5	8.0		9.1	7.7	
30.0	15.1	12.3	10.3	13.2	11.6	10.2	10.2	8.7	7.6	9.0	7.6	6.8	8.6	7.3	
32.0	14.5	11.9	10.0	12.5	11.1	9.9	9.7	8.3	7.3	8.6	7.3	6.5	8.1	7.0	6.3
34.0	13.9	11.4	9.8	11.9	10.6	9.7	9.2	8.0	7.0	8.1	7.0	6.3	7.7	6.7	6.0
36.0	13.3	11.1	9.5	11.3	10.1	9.4	8.7	7.7	6.8	7.7	6.7	6.1	7.3	6.4	5.8
38.0	12.7	10.7	9.3	10.8	9.7	9.0	8.3	7.4	6.6	7.3	6.4	5.8	6.9	6.1	5.6
40.0	12.1	10.4	9.1	10.4	9.3	8.7	7.9	7.1	6.4	6.9	6.2	5.6	6.5	5.9	5.4
42.0	11.6	10.1	8.9	9.9	9.0	8.4	7.5	6.9	6.2	6.6	5.9	5.4	6.2	5.7	5.1
44.0	11.1	9.8	8.8	9.5	8.6	8.1	7.2	6.6	6.1	6.3	5.7	5.3	5.8	5.4	4.9
46.0	10.6	9.6	8.7	9.2	8.3	7.9	6.9	6.3	5.9	6.0	5.5	5.1	5.4	5.1	4.7
48.0	9.7	9.3	8.5	8.8	8.1	7.6	6.6	6.1	5.8	5.7	5.3	4.9	5.0	4.8	4.5
50.0	8.8	9.1	8.4	8.5	7.8	7.4	6.4	5.9	5.6	5.4	5.1	4.8	4.6	4.4	4.3
54.0	7.3	8.0	8.3	7.2	7.3	7.0	5.9	5.5	5.2	4.8	4.6	4.4	4.0	3.9	3.9
58.0	6.0	6.5	6.6	5.9	6.6	6.7	5.4	5.1	4.9	4.3	4.1	4.0	3.4	3.4	3.4
62.0	4.9	5.1		4.8	5.3	5.4	4.9	4.7	4.5	3.8	3.7	3.6	2.9	2.9	3.0
66.0				3.9	4.1		4.0	4.3	4.3	3.5	3.3	3.3	2.5	2.5	2.6
70.0							3.1	3.4		3.1	3.0	3.0	2.1	2.1	2.3
74.0										2.5	2.8		1.8	1.8	1.9
78.0										1.8	2.0		1.5	1.6	

DIN/ISO/EN															
	40.4 m + 2.0 m + 23.5 m			45.4 m + 2.0 m + 23.5 m			50.5 m + 2.0 m + 23.5 m			55.6 m + 2.0 m + 23.5 m			60.0 m + 2.0 m + 23.5 m		
	0°	20°	40°	0°	20°	40°	0°	20°	40°	0°	20°	40°	0°	20°	40°
11.0	26.7														
12.0	25.7														
14.0	23.9			22.1			17.8								
16.0	22.2			20.7			16.3			14.3			13.6		
18.0	20.8			19.4			15.1			13.2			12.6		
20.0	19.6	15.3		18.1			14.1			12.3			11.7		
22.0	18.5	14.6		16.9	13.8		13.2	10.4		11.5			10.9		
24.0	17.5	13.9		15.8	13.2		12.3	9.9		10.8	8.9		10.2		
26.0	16.6	13.3	10.9	14.8	12.6		11.5	9.5		10.1	8.4		9.6	8.1	
28.0	15.0	12.8	10.6	14.0	12.2	10.5	10.9	9.0		9.5	8.0		9.1	7.7	
30.0	13.2	12.3	10.3	12.9	11.6	10.2	10.2	8.7	7.6	9.0	7.6	6.8	8.6	7.3	
32.0	11.7	11.9	10.0	11.4	11.1	9.9	9.7	8.3	7.3	8.6	7.3	6.5	8.1	7.0	6.3
34.0	10.2	11.4	9.8	10.1	10.6	9.7	9.2	8.0	7.0	8.1	7.0	6.3	7.7	6.7	6.0
36.0	8.9	10.6	9.5	8.8	10.1	9.4	8.7	7.7	6.8	7.7	6.7	6.1	7.3	6.4	5.8
38.0	7.7	9.3	9.3	7.7	9.3	9.0	7.8	7.4	6.6	7.3	6.4	5.8	6.9	6.1	5.6
40.0	6.7	8.2	9.1	6.6	8.2	8.7	6.8	7.1	6.4	6.9	6.2	5.6	6.5	5.9	5.4
42.0	5.8	7.1	8.2	5.7	7.1	8.3	5.9	6.9	6.2	6.0	5.9	5.4	5.7	5.7	5.1
44.0	5.0	6.2	7.1	4.9	6.2	7.2	5.0	6.4	6.1	5.2	5.7	5.3	4.9	5.4	4.9
46.0	4.2	5.3	6.1	4.1	5.3	6.2	4.3	5.5	5.9	4.4	5.5	5.1	4.2	5.1	4.7
48.0	3.5	4.5	5.3	3.5	4.6	5.4	3.6	4.7	5.6	3.7	4.9	4.9	3.5	4.7	4.5
50.0	2.9	3.8	4.4	2.9	3.8	4.6	3.0	4.0	4.8	3.1	4.2	4.8	2.9	4.0	4.3
54.0	1.9	2.6	2.9	1.8	2.6	3.1	1.9	2.8	3.4	2.0	3.0	3.6		2.8	3.6
58.0		1.5	1.6		1.5	1.9		1.7	2.2		1.9	2.5			2.4

Tragfähigkeiten
Lifting capacities
Capacités de levage
Capacidades de elevación

98t

DIN/ISO/EN

m	40.4 m + 2.0 m + 29.5 m			45.4 m + 2.0 m + 29.5 m			50.5 m + 2.0 m + 29.5 m			55.6 m + 2.0 m + 29.5 m			60.0 m + 2.0 m + 29.5 m		
	0°	20°	40°	0°	20°	40°	0°	20°	40°	0°	20°	40°	0°	20°	40°
12.0	21.9														
14.0	20.4			18.9											
16.0	19.0			17.7			14.8			13.6					
18.0	17.8			16.7			13.7			12.5			11.9		
20.0	16.7			15.7			12.7			11.6			11.0		
22.0	15.8			14.9			11.9			10.7			10.2		
24.0	14.9	10.9		14.1	10.8		11.1			10.0			9.6		
26.0	14.1	10.4		13.4	10.3		10.5	8.2		9.4			9.0		
28.0	13.4	10.0		12.7	9.9		9.9	7.9		8.8	7.2		8.4		
30.0	12.8	9.6		12.1	9.5		9.3	7.5		8.3	6.9		7.9	6.6	
32.0	12.2	9.2	7.5	11.4	9.1	7.5	8.8	7.2		7.9	6.6		7.5	6.3	
34.0	11.6	8.8	7.3	10.8	8.8	7.3	8.3	6.9	6.0	7.5	6.3		7.1	5.9	
36.0	11.1	8.5	7.1	10.3	8.5	7.1	7.9	6.6	5.7	7.1	6.0	5.3	6.7	5.5	
38.0	10.6	8.2	6.9	9.8	8.2	6.9	7.5	6.3	5.5	6.7	5.7	5.1	6.4	5.2	4.4
40.0	10.1	7.9	6.8	9.3	7.9	6.7	7.1	6.1	5.4	6.4	5.5	4.9	5.9	4.9	4.2
42.0	9.7	7.7	6.6	8.9	7.7	6.5	6.8	5.9	5.2	6.1	5.2	4.7	5.4	4.6	4.0
44.0	9.3	7.4	6.4	8.5	7.4	6.4	6.4	5.7	5.0	5.8	5.0	4.6	5.0	4.3	3.8
46.0	8.9	7.2	6.3	8.2	7.2	6.3	6.1	5.5	4.9	5.4	4.8	4.4	4.6	4.1	3.6
48.0	8.6	7.0	6.2	7.8	7.0	6.1	5.9	5.3	4.7	5.1	4.7	4.2	4.2	3.9	3.4
50.0	8.3	6.8	6.1	7.5	6.8	6.0	5.5	5.1	4.6	4.7	4.4	4.1	3.9	3.6	3.3
54.0	7.4	6.5	5.9	7.0	6.3	5.8	4.9	4.5	4.3	4.1	3.9	3.8	3.3	3.2	3.0
58.0	6.1	6.2	5.8	6.0	5.9	5.6	4.4	4.1	3.9	3.6	3.4	3.3	2.8	2.7	2.7
62.0	5.0	5.6	5.7	4.9	5.5	5.2	4.0	3.7	3.5	3.2	3.0	2.9	2.3	2.3	2.4
66.0	4.1	4.4		3.9	4.5	4.7	3.6	3.3	3.2	2.8	2.6	2.6	1.9	1.9	2.0
70.0				3.1	3.5		3.1	3.0	2.9	2.4	2.3	2.3	1.5	1.6	1.7
74.0				2.0	2.5			2.4	2.8		2.1	2.0	2.0		
78.0								1.7	1.9			1.8	1.7	1.7	
82.0												1.5			

58t

DIN/ISO/EN

m	40.4 m + 2.0 m + 29.5 m			45.4 m + 2.0 m + 29.5 m			50.5 m + 2.0 m + 29.5 m			55.6 m + 2.0 m + 29.5 m			60.0 m + 2.0 m + 29.5 m		
	0°	20°	40°	0°	20°	40°	0°	20°	40°	0°	20°	40°	0°	20°	40°
12.0	21.9														
14.0	20.4			18.9											
16.0	19.0			17.7			14.8			13.6					
18.0	17.8			16.7			13.7			12.5			11.9		
20.0	16.7			15.7			12.7			11.6			11.0		
22.0	15.8			14.9			11.9			10.7			10.2		
24.0	14.9	10.9		14.1	10.8		11.1			10.0			9.6		
26.0	14.1	10.4		13.4	10.3		10.5	8.2		9.4			9.0		
28.0	13.4	10.0		12.7	9.9		9.9	7.9		8.8	7.2		8.4		
30.0	12.8	9.6		12.1	9.5		9.3	7.5		8.3	6.9		7.9	6.6	
32.0	11.6	9.2	7.5	11.2	9.1	7.5	8.8	7.2		7.9	6.6		7.5	6.3	
34.0	10.3	8.8	7.3	9.9	8.8	7.3	8.3	6.9	6.0	7.5	6.3		7.1	5.9	
36.0	9.1	8.5	7.1	8.8	8.5	7.1	7.9	6.6	5.7	7.1	6.0	5.3	6.7	5.5	
38.0	7.9	8.2	6.9	7.8	8.2	6.9	7.5	6.3	5.5	6.7	5.7	5.1	6.4	5.2	4.4
40.0	6.9	7.9	6.8	6.7	7.9	6.7	6.8	6.1	5.4	6.4	5.5	4.9	5.9	4.9	4.2
42.0	5.9	7.7	6.6	5.8	7.6	6.5	5.9	5.9	5.2	6.0	5.2	4.7	5.4	4.6	4.0
44.0	5.1	6.7	6.4	5.0	6.6	6.4	5.1	5.7	5.0	5.2	5.0	4.6	4.8	4.3	3.8
46.0	4.4	5.8	6.3	4.2	5.8	6.3	4.3	5.5	4.9	4.5	4.8	4.4	4.2	4.1	3.6
48.0	3.7	5.0	6.1	3.6	5.0	6.1	3.6	5.1	4.7	3.9	4.7	4.2	3.5	3.9	3.4
50.0	3.1	4.3	5.3	2.9	4.3	5.3	3.0	4.4	4.6	3.3	4.4	4.1	3.0	3.6	3.3
54.0	2.0	3.0	3.8	1.9	3.0	3.8	1.9	3.1	4.0	2.2	3.4	3.8		3.2	3.0
58.0		1.9	2.4		1.9	2.6		2.0	2.8		2.3	3.1			2.7
62.0												2.0			

Tragfähigkeiten
Lifting capacities
Capacités de levage
Capacidades de elevación

98t

DIN/ISO/EN

	40.4 m + 2.0 m + 35.5 m			45.4 m + 2.0 m + 35.5 m			50.5 m + 2.0 m + 35.5 m			55.6 m + 2.0 m + 35.5 m			60.0 m + 2.0 m + 35.5 m		
	0°	20°	40°	0°	20°	40°	0°	20°	40°	0°	20°	40°	0°	20°	40°
14.0	17.2														
16.0	16.2			15.1											
18.0	15.3			14.3			12.9			11.0					
20.0	14.5			13.6			12.1			10.7			9.7		
22.0	13.7			12.9			11.3			9.9			9.5		
24.0	12.8			12.3			10.5			9.2			8.8		
26.0	12.0	8.5		11.7			9.9			8.6			8.2		
28.0	11.3	8.1		11.1	8.1		9.3			8.1			7.7		
30.0	10.7	7.8		10.6	7.7		8.7	6.9		7.6			7.3		
32.0	10.1	7.5		10.1	7.4		8.3	6.6		7.2	5.9		6.9	5.4	
34.0	9.6	7.1		9.7	7.1		7.8	6.3		6.8	5.6		6.5	5.0	
36.0	9.1	6.9	5.6	9.2	6.8		7.4	6.0		6.4	5.3		6.1	4.7	
38.0	8.7	6.6	5.4	8.8	6.6	5.4	7.1	5.7		6.1	5.1		5.8	4.4	
40.0	8.3	6.3	5.3	8.4	6.3	5.2	6.7	5.5	4.8	5.8	4.9		5.3	4.1	
42.0	7.9	6.1	5.1	8.1	6.1	5.1	6.4	5.3	4.6	5.5	4.7	4.1	4.9	3.9	3.3
44.0	7.6	5.9	5.0	7.7	5.9	4.9	6.1	5.1	4.5	5.2	4.5	3.9	4.5	3.6	3.1
46.0	7.3	5.7	4.8	7.4	5.7	4.8	5.8	4.9	4.3	4.8	4.3	3.7	4.1	3.4	2.9
48.0	7.0	5.5	4.7	7.1	5.5	4.7	5.4	4.7	4.2	4.5	4.0	3.5	3.7	3.2	2.7
50.0	6.7	5.3	4.6	6.8	5.4	4.6	5.1	4.6	4.0	4.1	3.8	3.3	3.4	3.0	2.6
54.0	6.2	5.0	4.4	6.2	5.0	4.4	4.5	4.1	3.7	3.6	3.4	3.0	2.8	2.6	2.3
58.0	5.8	4.8	4.3	5.6	4.8	4.2	3.9	3.6	3.4	3.0	2.9	2.7	2.3	2.3	2.0
62.0	5.2	4.5	4.1	5.0	4.5	4.1	3.5	3.2	3.0	2.6	2.5	2.4	1.9	1.9	1.8
66.0	4.2	4.3	4.1	4.1	4.1	3.9	3.1	2.8	2.7	2.2	2.1	2.1	1.5	1.6	1.6
70.0	3.4	3.9	4.0	3.2	3.8	3.6	2.7	2.5	2.4	1.9	1.8	1.8			
74.0	2.7	2.9		2.5	3.0	3.1	2.4	2.2	2.1	1.5	1.5	1.5			
78.0				1.8	2.1		1.9	2.0	1.9						
82.0								1.6							

58t

DIN/ISO/EN

	40.4 m + 2.0 m + 35.5 m			45.4 m + 2.0 m + 35.5 m			50.5 m + 2.0 m + 35.5 m			55.6 m + 2.0 m + 35.5 m			60.0 m + 2.0 m + 35.5 m		
	0°	20°	40°	0°	20°	40°	0°	20°	40°	0°	20°	40°	0°	20°	40°
14.0	17.2														
16.0	16.2			15.1											
18.0	15.3			14.3			12.9			11.0					
20.0	14.5			13.6			12.1			10.7			9.7		
22.0	13.7			12.9			11.3			9.9			9.5		
24.0	12.8			12.3			10.5			9.2			8.8		
26.0	12.0	8.5		11.7			9.9			8.6			8.2		
28.0	11.3	8.1		11.1	8.1		9.3			8.1			7.7		
30.0	10.7	7.8		10.6	7.7		8.7	6.9		7.6			7.3		
32.0	10.1	7.5		10.1	7.4		8.3	6.6		7.2	5.9		6.9	5.4	
34.0	9.6	7.1		9.7	7.1		7.8	6.3		6.8	5.6		6.5	5.0	
36.0	9.1	6.9	5.6	9.2	6.8		7.4	6.0		6.4	5.3		6.1	4.7	
38.0	8.2	6.6	5.4	7.8	6.6	5.4	7.1	5.7		6.1	5.1		5.8	4.4	
40.0	7.1	6.3	5.3	6.9	6.3	5.2	6.7	5.5	4.8	5.8	4.9		5.3	4.1	
42.0	6.2	6.1	5.1	6.0	6.1	5.1	6.1	5.3	4.6	5.5	4.7	4.1	4.9	3.9	3.3
44.0	5.4	5.9	5.0	5.2	5.9	4.9	5.3	5.1	4.5	5.2	4.5	3.9	4.5	3.6	3.1
46.0	4.6	5.7	4.8	4.5	5.7	4.8	4.6	4.9	4.3	4.5	4.3	3.7	4.1	3.4	2.9
48.0	3.9	5.5	4.7	3.8	5.5	4.7	4.0	4.7	4.2	3.9	4.0	3.5	3.5	3.2	2.7
50.0	3.3	4.8	4.6	3.1	4.8	4.6	3.4	4.6	4.0	3.3	3.8	3.3	2.9	3.0	2.6
54.0	2.2	3.5	4.4	2.1	3.5	4.4	2.3	3.7	3.7	2.3	3.4	3.0		2.6	2.3
58.0		2.4	3.3		2.3	3.3		2.6	3.4		2.7	2.7			2.0
62.0			2.1			2.2			2.5			2.4			

Tragfähigkeiten
Lifting capacities
Capacités de levage
Capacidades de elevación

98t

DIN/ISO/EN

m	40.4 m + 2.0 m + 41.5 m			45.4 m + 2.0 m + 41.5 m			50.5 m + 2.0 m + 41.5 m			55.6 m + 2.0 m + 41.5 m			60.0 m + 2.0 m + 41.5 m		
	0°	20°	40°	0°	20°	40°	0°	20°	40°	0°	20°	40°	0°	20°	40°
16.0	13.4			12.3											
18.0	12.7			11.7			10.5								
20.0	12.0			11.1			10.0			8.9					
22.0	11.3			10.5			9.6			8.6			7.9		
24.0	10.6			10.0			9.2			8.2			7.7		
26.0	10.0			9.5			8.8			7.8			7.4		
28.0	9.3			9.1			8.3			7.3			6.9		
30.0	8.8	6.2		8.7			7.8			6.8			6.5		
32.0	8.3	5.9		8.3	5.8		7.3			6.4			6.1		
34.0	7.8	5.6		7.9	5.6		6.9	5.4		6.0			5.6		
36.0	7.4	5.4		7.5	5.3		6.5	5.2		5.7	4.6		5.1	3.7	
38.0	7.0	5.1		7.1	5.1		6.2	4.9		5.3	4.3		4.7	3.4	
40.0	6.6	4.9		6.7	4.9		5.9	4.7		5.0	4.0		4.3	3.1	
42.0	6.3	4.7	3.8	6.4	4.7		5.5	4.4		4.6	3.7		3.9	2.9	
44.0	6.0	4.5	3.6	6.1	4.5	3.6	5.1	4.2		4.2	3.4		3.6	2.7	
46.0	5.7	4.3	3.5	5.8	4.3	3.5	4.8	3.9	3.2	3.8	3.2		3.3	2.5	
48.0	5.5	4.1	3.4	5.6	4.2	3.4	4.4	3.7	3.0	3.5	3.0	2.5	2.9	2.3	1.9
50.0	5.2	4.0	3.3	5.3	4.0	3.3	4.1	3.5	2.9	3.2	2.7	2.3	2.6	2.1	1.7
54.0	4.8	3.7	3.0	4.9	3.7	3.1	3.5	3.1	2.5	2.6	2.4	2.0	2.1	1.7	
58.0	4.4	3.4	2.8	4.5	3.5	2.9	3.0	2.7	2.3	2.1	2.0	1.7	1.6		
62.0	4.0	3.2	2.7	4.0	3.2	2.7	2.5	2.3	2.0	1.7	1.6				
66.0	3.7	3.0	2.5	3.5	3.0	2.5	2.1	1.9	1.8						
70.0	3.3	2.8	2.4	3.1	2.7	2.4	1.8	1.6	1.5						
74.0	2.6	2.6	2.4	2.3	2.4	2.3									
78.0	1.9	2.3		1.7	2.1	2.0									
82.0					1.5										

58t

DIN/ISO/EN

m	40.4 m + 2.0 m + 41.5 m			45.4 m + 2.0 m + 41.5 m			50.5 m + 2.0 m + 41.5 m			55.6 m + 2.0 m + 41.5 m			60.0 m + 2.0 m + 41.5 m		
	0°	20°	40°	0°	20°	40°	0°	20°	40°	0°	20°	40°	0°	20°	40°
16.0	13.4			12.3											
18.0	12.7			11.7			10.5								
20.0	12.0			11.1			10.0			8.9					
22.0	11.3			10.5			9.6			8.6			7.9		
24.0	10.6			10.0			9.2			8.2			7.7		
26.0	10.0			9.5			8.8			7.8			7.4		
28.0	9.3			9.1			8.3			7.3			6.9		
30.0	8.8	6.2		8.7			7.8			6.8			6.5		
32.0	8.3	5.9		8.3	5.8		7.3			6.4			6.1		
34.0	7.8	5.6		7.9	5.6		6.9	5.4		6.0			5.6		
36.0	7.4	5.4		7.5	5.3		6.5	5.2		5.7	4.6		5.1	3.7	
38.0	7.0	5.1		7.1	5.1		6.2	4.9		5.3	4.3		4.7	3.4	
40.0	6.6	4.9		6.6	4.9		5.9	4.7		5.0	4.0		4.3	3.1	
42.0	6.2	4.7	3.8	6.1	4.7		5.5	4.4		4.6	3.7		3.9	2.9	
44.0	5.4	4.5	3.6	5.0	4.5	3.6	4.9	4.2		4.2	3.4		3.6	2.7	
46.0	4.7	4.3	3.5	4.3	4.3	3.5	4.2	3.9	3.2	3.8	3.2		3.3	2.5	
48.0	4.0	4.1	3.4	3.7	4.2	3.4	3.6	3.7	3.0	3.4	3.0	2.5	2.9	2.3	1.9
50.0	3.4	4.0	3.3	3.1	4.0	3.3	3.0	3.5	2.9	2.9	2.7	2.3		2.1	1.7
54.0	2.3	3.7	3.0		3.7	3.1		3.1	2.5		2.4	2.0		1.7	
58.0		2.7	2.8		2.6	2.9		2.6	2.3			1.7			
62.0		1.7	2.7			2.7			2.0						

Tragfähigkeiten
Lifting capacities
Capacités de levage
Capacidades de elevación

DIN/ISO/EN

m	40.4 m + 2.0 m + 47.5 m			45.4 m + 2.0 m + 47.5 m			50.5 m + 2.0 m + 47.5 m			55.6 m + 2.0 m + 47.5 m			60.0 m + 2.0 m + 47.5 m		
	0°	20°	40°	0°	20°	40°	0°	20°	40°	0°	20°	40°	0°	20°	40°
16.0	10.7														
18.0	10.1			9.3											
20.0	9.6			8.8			7.8								
22.0	9.0			8.3			7.5			6.5					
24.0	8.5			7.9			7.1			6.3			5.8		
26.0	8.1			7.5			6.8			6.0			5.6		
28.0	7.6			7.1			6.5			5.8			5.4		
30.0	7.2			6.8			6.2			5.6			5.2		
32.0	6.7			6.5			5.9			5.3			4.9		
34.0	6.3	4.4		6.2			5.6			5.1			4.7		
36.0	6.0	4.1		5.9	4.1		5.4			4.9			4.2		
38.0	5.6	3.9		5.6	3.9		5.2	3.8		4.6			3.8		
40.0	5.3	3.7		5.3	3.7		4.9	3.6		4.2	3.1		3.5	2.3	
42.0	5.0	3.5		5.1	3.5		4.7	3.5		3.8	2.8		3.1	2.1	
44.0	4.7	3.4		4.8	3.4		4.4	3.2		3.5	2.6		2.8	1.9	
46.0	4.5	3.2		4.6	3.2		4.0	3.0		3.2	2.4		2.5	1.7	
48.0	4.2	3.0	2.2	4.3	3.0		3.6	2.8		2.8	2.1		2.2	1.5	
50.0	4.0	2.9	2.0	4.1	2.9	2.0	3.3	2.6		2.5	1.9		2.0		
54.0	3.6	2.6	1.8	3.7	2.6	1.8	2.7	2.2	1.6	2.0	1.5		1.5		
58.0	3.3	2.3	1.6	3.4	2.4	1.6	2.2	1.9		1.5					
62.0	2.9	2.0	1.5	3.1	2.1	1.5	1.8	1.6							
66.0	2.6	1.8		2.6	1.9										
70.0	2.3	1.6		2.2	1.7										
74.0	2.0			1.8	1.5										
78.0	1.8			1.5											

MB+FJ

DIN/ISO/EN

m	40.4 m + 2.0 m + 47.5 m			45.4 m + 2.0 m + 47.5 m			50.5 m + 2.0 m + 47.5 m			55.6 m + 2.0 m + 47.5 m			60.0 m + 2.0 m + 47.5 m		
	0°	20°	40°	0°	20°	40°	0°	20°	40°	0°	20°	40°	0°	20°	40°
16.0	10.7														
18.0	10.1			9.3											
20.0	9.6			8.8			7.8								
22.0	9.0			8.3			7.5			6.5					
24.0	8.5			7.9			7.1			6.3			5.8		
26.0	8.1			7.5			6.8			6.0			5.6		
28.0	7.6			7.1			6.5			5.8			5.4		
30.0	7.2			6.8			6.2			5.6			5.2		
32.0	6.7			6.5			5.9			5.3			4.9		
34.0	6.3	4.4		6.2			5.6			5.1			4.7		
36.0	6.0	4.1		5.9	4.1		5.4			4.9			4.2		
38.0	5.6	3.9		5.6	3.9		5.2	3.8		4.6			3.8		
40.0	5.3	3.7		5.3	3.7		4.9	3.6		4.2	3.1		3.5	2.3	
42.0	5.0	3.5		5.1	3.5		4.7	3.5		3.8	2.8		3.1	2.1	
44.0	4.7	3.4		4.8	3.4		4.4	3.2		3.5	2.6		2.8	1.9	
46.0	4.5	3.2		4.2	3.2		4.0	3.0		3.2	2.4		2.5	1.7	
48.0	3.9	3.0	2.2	3.5	3.0		3.4	2.8		2.8	2.1			1.5	
50.0	3.3	2.9	2.0	2.9	2.9	2.0	2.8	2.6			1.9				
54.0	2.2	2.6	1.8		2.6	1.8		2.2	1.6		1.5				
58.0		2.3	1.6		2.4	1.6									
62.0			1.5			1.5									

Hubhöhen
Lifting heights
Hauteurs de levage
Alturas de elevación

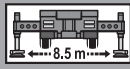
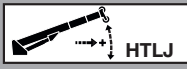
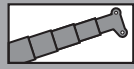

98t

DIN/ISO/EN

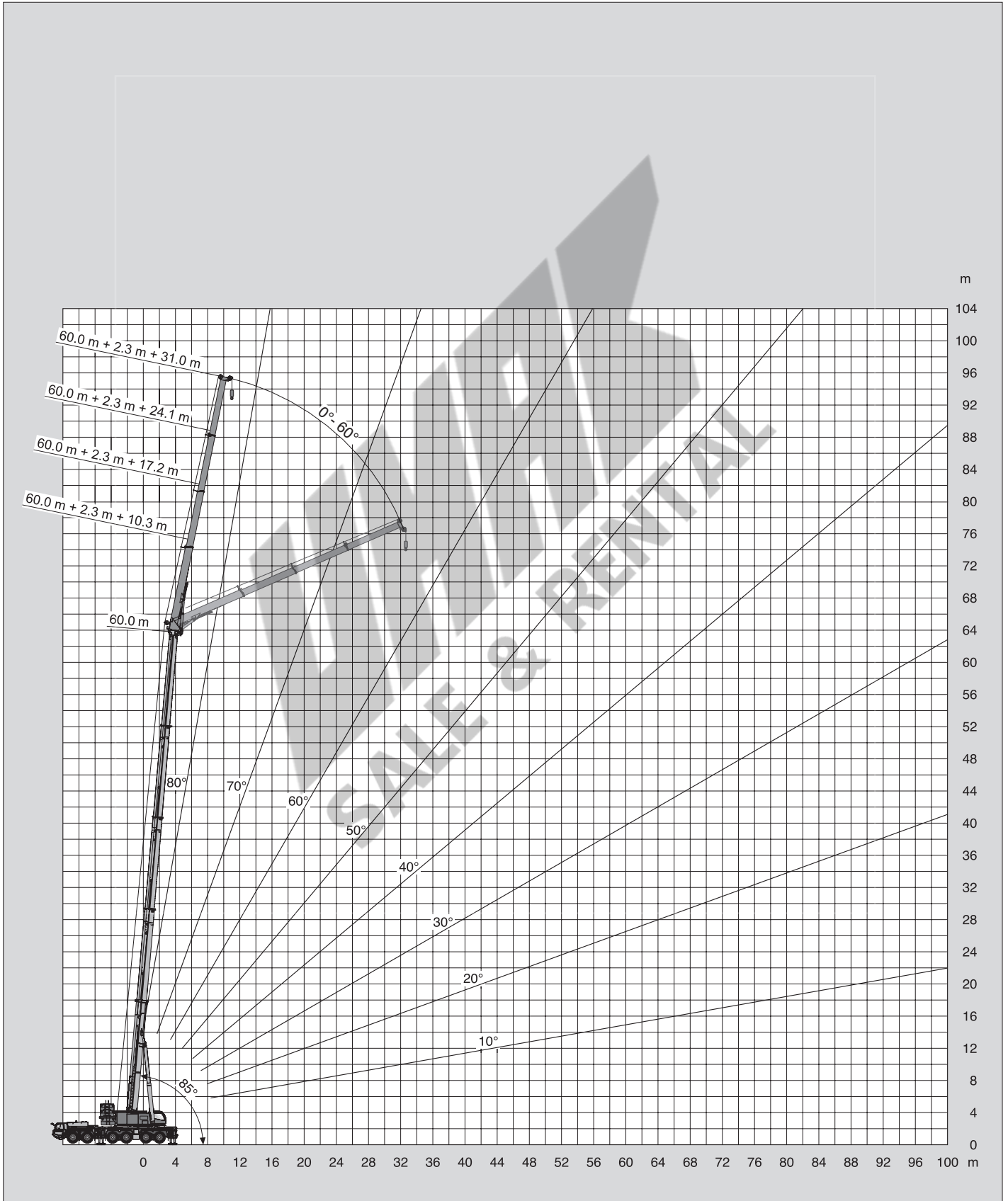

Tragfähigkeiten
Lifting capacities
Capacités de levage
Capacidades de elevación

98t

DIN/ISO/EN

	40.4 m + 2.3 m + 10.3 m					40.4 m + 2.3 m + 17.2 m					40.4 m + 2.3 m + 24.1 m					40.4 m + 2.3 m + 31.0 m				
	5°	15°	30°	45°	60°	5°	15°	30°	45°	60°	5°	15°	30°	45°	60°	5°	15°	30°	45°	60°
9.0	38.4																			
10.0	36.0					16.7														
11.0	33.8	31.6				16.7														
12.0	31.9	30.2				16.7														
14.0	28.6	27.3	25.2			16.7	16.7				16.0									
16.0	25.8	24.8	23.5	22.1	21.1	16.7	16.7				15.5					10.9				
18.0	23.5	22.6	21.6	20.9	20.3	16.7	16.7	16.7			15.0	13.5				10.8				
20.0	21.5	20.8	19.9	19.4	19.0	16.7	16.7	15.9			14.5	13.0				10.5				
22.0	19.8	19.2	18.5	18.0	17.7	16.7	16.7	15.2	14.0		13.9	12.5				10.3	9.2			
24.0	18.3	17.8	17.2	16.8	16.5	16.7	16.2	14.5	13.4	12.9	13.4	12.1	10.8			10.0	8.8			
26.0	17.0	16.5	16.0	15.7	15.5	15.9	15.4	13.9	13.0	12.5	12.9	11.7	10.5			9.7	8.4			
28.0	15.8	15.4	15.0	14.7	14.6	14.8	14.4	13.3	12.5	12.1	12.5	11.4	10.1	9.3		9.2	8.1			
30.0	13.9	14.2	14.0	13.8		13.9	13.5	12.8	12.1	11.8	12.1	11.1	9.8	9.0	8.5	8.8	7.8	6.7		
32.0	12.1	12.4	12.7	12.9		13.0	12.6	12.2	11.8	11.6	11.7	10.8	9.5	8.8	8.4	8.5	7.5	6.4		
34.0	10.5	10.8	11.1	11.2		11.9	11.9	11.5	11.3	11.2	11.3	10.4	9.3	8.6	8.3	8.1	7.2	6.2		
36.0	9.1	9.4	9.6	9.7		10.5	10.9	10.9	10.7	10.6	10.9	10.0	9.0	8.5	8.2	7.8	6.9	6.1	5.5	
38.0	7.9	8.1	8.3	8.3		9.3	9.7	10.1	10.1		10.2	9.6	8.8	8.3	8.1	7.5	6.7	5.9	5.3	
40.0	6.7	6.9	7.1			8.2	8.5	9.0	9.2		9.1	9.3	8.5	8.1	8.0	7.2	6.5	5.7	5.2	5.0
42.0	5.7	5.9	6.0			7.1	7.5	7.9	8.1		8.1	8.5	8.2	7.9		7.0	6.3	5.5	5.1	5.0
44.0	4.8	4.9	5.0			6.2	6.5	6.9	7.0		7.2	7.6	8.0	7.7		6.7	6.1	5.4	5.0	4.9
46.0	3.9	4.0				5.3	5.6	5.9			6.3	6.8	7.3	7.4		6.5	5.9	5.3	4.9	4.8
48.0	3.1	3.2				4.6	4.8	5.0			5.6	6.0	6.5	6.7		6.3	5.7	5.1	4.8	
50.0						3.8	4.0	4.2			4.9	5.2	5.7	5.9		5.9	5.5	5.0	4.7	
54.0						2.5	2.7				3.6	3.9	4.2			4.6	5.0	4.8	4.6	
58.0											2.5	2.7	2.9			3.5	3.9	4.3		
62.0											1.5	1.6				2.5	2.8	3.1		
66.0																1.7	1.9			

58t

DIN/ISO/EN

	40.4 m + 2.3 m + 10.3 m					40.4 m + 2.3 m + 17.2 m					40.4 m + 2.3 m + 24.1 m					40.4 m + 2.3 m + 31.0 m				
	5°	15°	30°	45°	60°	5°	15°	30°	45°	60°	5°	15°	30°	45°	60°	5°	15°	30°	45°	60°
9.0	38.4																			
10.0	36.0					16.7														
11.0	33.8	31.6				16.7														
12.0	31.9	30.2				16.7														
14.0	28.6	27.3	25.2			16.7	16.7				16.0									
16.0	25.8	24.8	23.5	22.1	21.1	16.7	16.7				15.5					10.9				
18.0	23.5	22.6	21.6	20.9	20.3	16.7	16.7	16.7			15.0	13.5				10.8				
20.0	20.5	20.8	19.9	19.4	19.0	16.7	16.7	15.9			14.5	13.0				10.5				
22.0	16.8	17.9	18.5	18.0	17.7	16.7	16.7	15.2	14.0		13.9	12.5				10.3	9.2			
24.0	13.8	14.7	15.9	16.8	16.5	15.7	16.2	14.5	13.4	12.9	13.4	12.1	10.8			10.0	8.8			
26.0	11.3	12.1	13.1	13.8	14.2	13.2	14.5	13.9	13.0	12.5	12.9	11.7	10.5			9.7	8.4			
28.0	9.1	9.8	10.7	11.3	11.5	11.0	12.2	13.3	12.5	12.1	12.4	11.4	10.1	9.3		9.2	8.1			
30.0	7.2	7.9	8.6	9.1		9.2	10.2	11.7	12.1	11.8	10.6	11.1	9.8	9.0	8.5	8.8	7.8	6.7		
32.0	5.5	6.1	6.7	7.0		7.5	8.5	9.8	10.8	11.4	9.0	10.3	9.5	8.8	8.4	8.5	7.5	6.4		
34.0	4.0	4.5	5.0	5.2		6.1	7.0	8.1	9.0	9.4	7.5	8.8	9.3	8.6	8.3	8.1	7.2	6.2		
36.0	2.6	3.1	3.5	3.7		4.8	5.6	6.6	7.3	7.5	6.3	7.4	8.9	8.5	8.2	7.6	6.9	6.1	5.5	
38.0			2.2	2.3		3.6	4.3	5.2	5.8		5.1	6.2	7.5	8.3	8.1	6.4	6.7	5.9	5.3	
40.0						2.6	3.2	3.9	4.4		4.1	5.0	6.3	7.2	7.7	5.4	6.5	5.7	5.2	5.0
42.0							2.2	2.8	3.1		3.1	4.0	5.1	5.9		4.5	5.6	5.5	5.1	5.0
44.0											2.3	3.0	4.0	4.7		3.6	4.7	5.4	5.0	4.9
46.0												2.2	3.0	3.6		2.9	3.8	5.1	4.9	4.8
48.0													2.1	2.6			3.0	4.2	4.8	
50.0																	2.3	3.3	4.1	
54.0																			2.4	

MB + HTLJ

Tragfähigkeiten
Lifting capacities
Capacités de levage
Capacidades de elevación

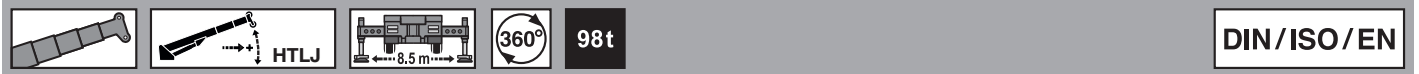

m	45.4 m + 2.3 m + 10.3 m					45.4 m + 2.3 m + 17.2 m					45.4 m + 2.3 m + 24.1 m					45.4 m + 2.3 m + 31.0 m				
	5°	15°	30°	45°	60°	5°	15°	30°	45°	60°	5°	15°	30°	45°	60°	5°	15°	30°	45°	60°
10.0	29.3																			
11.0	27.6																			
12.0	26.1	24.4				16.7														
14.0	23.5	22.1	20.5			16.7					14.5									
16.0	21.3	20.2	18.8	17.9		16.7	16.7				14.5					10.2				
18.0	19.5	18.5	17.4	16.6	15.4	16.7	16.7				14.1					10.0				
20.0	17.9	17.1	16.1	15.5	15.1	16.4	15.4	14.3			13.7	12.5				9.8				
22.0	16.5	15.8	15.0	14.4	14.1	15.2	14.3	13.3			13.4	12.1				9.6	8.8			
24.0	15.3	14.7	14.0	13.5	13.2	14.1	13.3	12.5	11.9		13.0	11.7				9.4	8.4			
26.0	14.2	13.7	13.1	12.7	12.5	13.1	12.4	11.7	11.2	10.1	12.1	11.4	10.1			9.2	8.1			
28.0	13.3	12.8	12.3	12.0	11.8	12.2	11.6	11.0	10.5	9.9	11.3	10.7	9.8			8.9	7.8			
30.0	12.1	12.0	11.6	11.3	11.2	11.4	10.9	10.3	9.9	9.7	10.6	10.0	9.4	8.8		8.6	7.5	6.5		
32.0	10.8	10.8	10.7	10.6		10.7	10.2	9.7	9.4	9.2	9.9	9.4	8.9	8.5	7.3	8.2	7.3	6.3		
34.0	9.7	9.7	9.6	9.6		10.0	9.6	9.2	8.9	8.7	9.3	8.9	8.4	8.1	7.2	7.9	7.0	6.1		
36.0	8.3	8.6	8.7	8.6		9.1	9.1	8.7	8.4	8.3	8.8	8.4	7.9	7.7	7.1	7.6	6.8	5.9	5.4	
38.0	7.1	7.3	7.6	7.7		8.2	8.2	8.0	7.8	7.7	8.2	7.9	7.5	7.2	7.0	7.4	6.6	5.7	5.3	
40.0	5.9	6.2	6.4	6.5		7.4	7.4	7.4	7.3		7.5	7.2	6.9	6.7	6.5	7.1	6.4	5.6	5.1	4.9
42.0	4.9	5.2	5.4			6.4	6.7	6.8	6.7		6.9	6.7	6.4	6.2	6.1	6.9	6.2	5.4	5.0	4.9
44.0	4.0	4.2	4.4			5.5	5.8	6.1	6.1		6.2	6.2	5.9	5.8		6.3	6.0	5.3	4.9	4.8
46.0	3.2	3.3	3.5			4.6	5.0	5.4	5.5		5.6	5.7	5.5	5.3		5.8	5.7	5.2	4.8	4.7
48.0	2.4	2.5	2.6			3.8	4.2	4.5	4.6		4.9	5.2	5.1	4.9		5.4	5.2	5.0	4.7	4.7
50.0	1.7	1.8				3.1	3.4	3.7			4.2	4.6	4.7	4.6		5.0	4.8	4.7	4.5	
54.0						1.9	2.1	2.2			2.9	3.3	3.7			3.9	4.1	4.0	3.9	
58.0											1.8	2.1	2.4			2.8	3.3	3.3	3.3	



m	45.4 m + 2.3 m + 10.3 m					45.4 m + 2.3 m + 17.2 m					45.4 m + 2.3 m + 24.1 m					45.4 m + 2.3 m + 31.0 m				
	5°	15°	30°	45°	60°	5°	15°	30°	45°	60°	5°	15°	30°	45°	60°	5°	15°	30°	45°	60°
10.0	29.3																			
11.0	27.6																			
12.0	26.1	24.4				16.7														
14.0	23.5	22.1	20.5			16.7					14.5									
16.0	21.3	20.2	18.8	17.9		16.7	16.7				14.5					10.2				
18.0	19.5	18.5	17.4	16.6	15.4	16.7	16.7				14.1					10.0				
20.0	17.9	17.1	16.1	15.5	15.1	16.4	15.4	14.3			13.7	12.5				9.8				
22.0	16.3	15.8	15.0	14.4	14.1	15.2	14.3	13.3			13.4	12.1				9.6	8.8			
24.0	13.4	14.3	14.0	13.5	13.2	14.1	13.3	12.5	11.9		13.0	11.7				9.4	8.4			
26.0	10.9	11.7	12.8	12.7	12.5	12.7	12.4	11.7	11.2	10.1	12.1	11.4	10.1			9.2	8.1			
28.0	8.8	9.5	10.5	11.1	11.4	10.6	11.6	11.0	10.5	9.9	11.3	10.7	9.8			8.9	7.8			
30.0	7.0	7.6	8.4	9.0	9.2	8.8	9.9	10.3	9.9	9.7	10.1	10.0	9.4	8.8		8.6	7.5	6.5		
32.0	5.4	6.0	6.7	7.1		7.2	8.2	9.5	9.4	9.2	8.5	9.4	8.9	8.5	7.3	8.2	7.3	6.3		
34.0	4.0	4.5	5.1	5.5		5.8	6.7	7.9	8.8	8.7	7.1	8.4	8.4	8.1	7.2	7.9	7.0	6.1		
36.0		3.2	3.7	3.9		4.5	5.3	6.4	7.2	7.6	5.9	7.0	7.9	7.7	7.1	7.1	6.8	5.9	5.4	
38.0						3.4	4.1	5.1	5.8	6.0	4.8	5.8	7.3	7.2	7.0	6.0	6.6	5.7	5.3	
40.0							3.1	3.9	4.5		3.8	4.7	6.0	6.7	6.5	5.0	6.2	5.6	5.1	4.9
42.0								2.8	3.3		2.8	3.7	4.9	5.9	6.1	4.1	5.2	5.4	5.0	4.9
44.0												2.8	3.9	4.7		3.2	4.3	5.3	4.9	4.8
46.0													3.0	3.7			3.5	4.8	4.8	4.7
48.0														2.7			2.7	4.0	4.7	4.7
50.0																	3.2	4.1		

Tragfähigkeiten
Lifting capacities
Capacités de levage
Capacidades de elevación

98t

DIN/ISO/EN

	50.5 m + 2.3 m + 10.3 m					50.5 m + 2.3 m + 17.2 m					50.5 m + 2.3 m + 24.1 m					50.5 m + 2.3 m + 31.0 m				
	5°	15°	30°	45°	60°	5°	15°	30°	45°	60°	5°	15°	30°	45°	60°	5°	15°	30°	45°	60°
11.0	21.2																			
12.0	20.0																			
14.0	17.8	16.8				16.5														
16.0	16.0	15.2	14.2			15.0					13.0									
18.0	14.5	13.9	13.1	12.4	11.0	13.6	12.5				12.4					9.3				
20.0	13.2	12.7	12.1	11.6	10.7	12.4	11.7				11.5					9.3				
22.0	12.1	11.6	11.1	10.7	10.5	11.4	10.8	9.8			10.7	9.6				9.2				
24.0	11.1	10.7	10.3	9.9	9.7	10.5	10.0	9.2	8.5		9.9	9.0				9.0	8.3			
26.0	10.2	9.9	9.5	9.2	9.1	9.7	9.3	8.7	8.1	7.7	9.1	8.5	7.5			8.7	7.8			
28.0	9.3	9.0	8.7	8.5	8.3	8.9	8.6	8.2	7.7	7.4	8.4	8.0	7.1			8.2	7.4			
30.0	8.3	8.1	7.8	7.6	7.5	8.2	7.9	7.6	7.4	7.1	7.8	7.5	6.8			7.7	7.0			
32.0	7.4	7.2	7.0	6.9	6.7	7.3	7.1	6.9	6.7	6.6	7.1	6.9	6.4	6.0		7.2	6.6	5.9		
34.0	6.6	6.4	6.3	6.1		6.5	6.4	6.2	6.1	6.0	6.4	6.2	6.1	5.7	5.4	6.6	6.3	5.6		
36.0	5.8	5.7	5.6	5.5		5.9	5.7	5.6	5.5	5.4	5.7	5.6	5.5	5.4	5.2	5.9	5.8	5.3		
38.0	5.1	5.1	4.9	4.9		5.2	5.1	5.0	4.9	4.9	5.1	5.0	5.0	4.9	4.8	5.3	5.3	5.1	4.7	
40.0	4.5	4.5	4.4	4.3		4.6	4.6	4.5	4.4	4.4	4.6	4.5	4.5	4.4	4.4	4.8	4.8	4.7	4.5	
42.0	4.0	3.9	3.8	3.8		4.1	4.1	4.0	4.0		4.1	4.0	4.0	4.0	3.9	4.3	4.3	4.3	4.2	4.0
44.0	3.5	3.4	3.4	3.3		3.6	3.6	3.6	3.5		3.6	3.6	3.6	3.6	3.5	3.9	3.9	3.9	3.9	3.7
46.0	2.8	2.9	2.9			3.2	3.1	3.1	3.1		3.2	3.2	3.2	3.2		3.4	3.5	3.5	3.5	3.5
48.0	2.0	2.2	2.4			2.7	2.7	2.7	2.7		2.8	2.8	2.8	2.8		3.0	3.1	3.1	3.1	3.1
50.0		1.5	1.6			2.4	2.4	2.4	2.3		2.4	2.4	2.5	2.5		2.7	2.7	2.8	2.8	2.8
54.0						1.5	1.7	1.7			1.7	1.8	1.8	1.8		2.0	2.1	2.2	2.2	2.2
58.0																1.5	1.6	1.6	1.6	1.6



58t

DIN/ISO/EN

	50.5 m + 2.3 m + 10.3 m					50.5 m + 2.3 m + 17.2 m					50.5 m + 2.3 m + 24.1 m					50.5 m + 2.3 m + 31.0 m				
	5°	15°	30°	45°	60°	5°	15°	30°	45°	60°	5°	15°	30°	45°	60°	5°	15°	30°	45°	60°
11.0	21.2																			
12.0	20.0																			
14.0	17.8	16.8				16.5														
16.0	16.0	15.2	14.2			15.0					13.0									
18.0	14.5	13.9	13.1	12.4	11.0	13.6	12.5				12.4					9.3				
20.0	13.2	12.7	12.1	11.6	10.7	12.4	11.7				11.5					9.3				
22.0	12.1	11.6	11.1	10.7	10.5	11.4	10.8	9.8			10.7	9.6				9.2				
24.0	11.1	10.7	10.3	9.9	9.7	10.5	10.0	9.2	8.5		9.9	9.0				9.0	8.3			
26.0	10.2	9.9	9.5	9.2	9.1	9.7	9.3	8.7	8.1	7.7	9.1	8.5	7.5			8.7	7.8			
28.0	8.8	9.0	8.7	8.5	8.3	8.9	8.6	8.2	7.7	7.4	8.4	8.0	7.1			8.2	7.4			
30.0	7.0	7.7	7.8	7.6	7.5	8.2	7.9	7.6	7.4	7.1	7.8	7.5	6.8			7.7	7.0			
32.0	5.4	6.0	6.8	6.9	6.7	7.1	7.1	6.9	6.7	6.6	7.1	6.9	6.4	6.0		7.2	6.6	5.9		
34.0	4.1	4.6	5.2	5.7		5.7	6.4	6.2	6.1	6.0	6.4	6.2	6.1	5.7	5.4	6.6	6.3	5.6		
36.0			3.9	4.2		4.5	5.3	5.6	5.5	5.4	5.7	5.6	5.5	5.4	5.2	5.9	5.8	5.3		
38.0						3.4	4.1	5.0	4.9	4.9	4.6	5.0	5.0	4.9	4.8	5.3	5.3	5.1	4.7	
40.0							3.1	4.0	4.4	4.4	3.6	4.5	4.5	4.4	4.4	4.8	4.8	4.7	4.5	
42.0									3.5							3.9	4.3	4.3	4.2	4.0
44.0																3.1	3.9	3.9	3.9	3.7
46.0																	3.4	3.5	3.5	3.5
48.0																		3.1	3.1	3.1
50.0																		2.8	2.8	2.8

MB+HTLJ

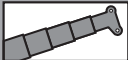
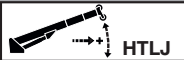
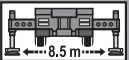
Tragfähigkeiten
Lifting capacities
Capacités de levage
Capacidades de elevación

98t

DIN/ISO/EN

m	55.6 m + 2.3 m + 10.3 m					55.6 m + 2.3 m + 17.2 m					55.6 m + 2.3 m + 24.1 m					55.6 m + 2.3 m + 31.0 m				
	5°	15°	30°	45°	60°	5°	15°	30°	45°	60°	5°	15°	30°	45°	60°	5°	15°	30°	45°	60°
12.0	16.1																			
14.0	15.6	14.5																		
16.0	13.9	13.2				12.7														
18.0	12.5	12.1	11.2			11.6	10.7				10.3									
20.0	11.3	11.0	10.4	9.9	8.5	10.7	9.8				10.1					6.9				
22.0	10.3	10.0	9.6	9.2	8.2	9.8	9.1	8.3			9.3	8.5				6.9				
24.0	9.3	9.1	8.8	8.6	8.0	8.9	8.5	7.8			8.6	7.9				6.9				
26.0	8.1	8.0	7.8	7.7	7.5	8.0	7.9	7.3	6.9		8.0	7.4				6.9	6.9			
28.0	7.0	6.9	6.8	6.7	6.6	7.0	6.9	6.8	6.5	6.2	7.3	6.9	6.3			6.9	6.4			
30.0	6.1	6.0	6.0	5.9	5.8	6.1	6.1	6.1	6.0	5.9	6.5	6.5	5.9			6.5	6.0			
32.0	5.2	5.2	5.2	5.1	5.0	5.3	5.3	5.3	5.3	5.3	5.7	5.7	5.6			5.8	5.6			
34.0	4.5	4.5	4.4	4.4	4.3	4.6	4.6	4.7	4.7	4.6	5.0	5.1	5.1	4.9		5.1	5.2	4.9		
36.0	3.8	3.8	3.8	3.7	3.7	3.9	4.0	4.1	4.1	4.0	4.4	4.5	4.6	4.5	4.3	4.5	4.6	4.5		
38.0	3.1	3.1	3.2	3.1		3.3	3.4	3.5	3.5	3.5	3.8	3.9	4.0	4.1	4.0	3.9	4.1	4.1		
40.0	2.5	2.6	2.6	2.6		2.8	2.9	3.0	3.0	3.0	3.2	3.4	3.5	3.6	3.6	3.4	3.6	3.7	3.5	
42.0	2.0	2.0	2.1	2.0		2.3	2.4	2.5	2.5	2.5	2.7	2.9	3.0	3.1	3.1	3.0	3.1	3.3	3.2	
44.0	1.5	1.5	1.6	1.6		1.8	1.9	2.0	2.1		2.3	2.4	2.6	2.7	2.7	2.5	2.7	2.9	2.9	2.8
46.0							1.5	1.6	1.6		1.9	2.0	2.2	2.3	2.3	2.1	2.3	2.5	2.6	2.6
48.0											1.5	1.6	1.8	1.9		1.7	1.9	2.1	2.3	2.3
50.0														1.5		1.6	1.8	1.9	2.0	2.0





58t

DIN/ISO/EN

m	55.6 m + 2.3 m + 10.3 m					55.6 m + 2.3 m + 17.2 m					55.6 m + 2.3 m + 24.1 m					55.6 m + 2.3 m + 31.0 m				
	5°	15°	30°	45°	60°	5°	15°	30°	45°	60°	5°	15°	30°	45°	60°	5°	15°	30°	45°	60°
12.0	16.1																			
14.0	15.6	14.5																		
16.0	13.9	13.2				12.7														
18.0	12.5	12.1	11.2			11.6	10.7				10.3									
20.0	11.3	11.0	10.4	9.9	8.5	10.7	9.8				10.1					6.9				
22.0	10.3	10.0	9.6	9.2	8.2	9.8	9.1	8.3			9.3	8.5				6.9				
24.0	9.3	9.1	8.8	8.6	8.0	8.9	8.5	7.8			8.6	7.9				6.9				
26.0	8.1	8.0	7.8	7.7	7.5	8.0	7.9	7.3	6.9		8.0	7.4				6.9	6.9			
28.0	7.0	6.9	6.8	6.7	6.6	7.0	6.9	6.8	6.5	6.2	7.3	6.9	6.3			6.9	6.4			
30.0	6.1	6.0	6.0	5.9	5.8	6.1	6.1	6.1	6.0	5.9	6.5	6.5	5.9			6.5	6.0			
32.0	5.2	5.2	5.2	5.1	5.0	5.3	5.3	5.3	5.3	5.3	5.7	5.7	5.6			5.8	5.6			
34.0	4.2	4.5	4.4	4.4	4.3	4.6	4.6	4.7	4.7	4.6	5.0	5.1	5.1	4.9		5.1	5.2	4.9		
36.0		3.5	3.8	3.7	3.7	3.9	4.0	4.1	4.1	4.0	4.4	4.5	4.6	4.5	4.3	4.5	4.6	4.5		
38.0							3.4	3.5	3.5	3.5	3.8	3.9	4.0	4.1	4.0	3.9	4.1	4.1		
40.0								3.0	3.0	3.0	3.2	3.4	3.5	3.6	3.6	3.4	3.6	3.7	3.5	
42.0									2.5	2.5		2.9	3.0	3.1	3.1	3.0	3.1	3.3	3.2	
44.0													2.6	2.7	2.7		2.7	2.9	2.9	2.8
46.0														2.3	2.3		2.3	2.5	2.6	2.6
48.0																		2.1	2.3	2.3
50.0																		1.9	2.0	2.0

Tragfähigkeiten
Lifting capacities
Capacités de levage
Capacidades de elevación

98t

DIN/ISO/EN

	60.0 m + 2.3 m + 10.3 m					60.0 m + 2.3 m + 17.2 m					60.0 m + 2.3 m + 24.1 m					60.0 m + 2.3 m + 31.0 m				
	5°	15°	30°	45°	60°	5°	15°	30°	45°	60°	5°	15°	30°	45°	60°	5°	15°	30°	45°	60°
14.0	13.2																			
16.0	12.8	12.3				8.8														
18.0	11.5	11.2	10.5			8.8					7.8									
20.0	10.4	10.1	9.7	9.2		8.8	8.8				7.8					6.2				
22.0	9.4	9.2	8.9	8.6	8.3	8.8	8.8				7.8					6.2				
24.0	8.2	8.1	8.0	7.9	7.7	8.5	8.2	7.5			7.8	7.4				6.2				
26.0	7.1	7.0	7.0	6.9	6.7	7.5	7.5	7.0			7.5	6.9				6.2				
28.0	6.1	6.1	6.0	6.0	5.9	6.5	6.5	6.5	6.2		6.6	6.5				6.2				
30.0	5.2	5.2	5.2	5.1	5.1	5.6	5.7	5.7	5.7	5.7	5.8	5.9	5.3			5.8	5.4			
32.0	4.4	4.4	4.4	4.4	4.3	4.9	4.9	5.0	5.0	5.0	5.0	5.1	4.9			5.1	4.9			
34.0	3.6	3.7	3.7	3.7	3.6	4.1	4.2	4.3	4.4	4.3	4.4	4.5	4.5	4.2		4.4	4.4			
36.0	3.0	3.0	3.1	3.1	3.0	3.5	3.6	3.7	3.8	3.7	3.7	3.9	4.1	3.9		3.8	4.0	3.6		
38.0	2.3	2.4	2.5	2.5		2.9	3.0	3.2	3.2	3.2	3.2	3.3	3.5	3.5	3.5	3.3	3.5	3.3		
40.0	1.8	1.8	1.9	1.9		2.3	2.5	2.6	2.7	2.7	2.6	2.8	3.0	3.2	3.2	2.8	3.0	3.0		
42.0						1.8	2.0	2.1	2.2	2.2	2.1	2.3	2.6	2.7	2.7	2.3	2.6	2.7	2.6	
44.0							1.5	1.7	1.8		1.7	1.9	2.1	2.3	2.3	1.9	2.2	2.5	2.4	
46.0												1.5	1.7	1.9	1.9	1.5	1.8	2.1	2.2	2.2
48.0													1.5	1.5			1.7	1.9	2.0	
50.0																		1.6	1.6	

58t

DIN/ISO/EN

	60.0 m + 2.3 m + 10.3 m					60.0 m + 2.3 m + 17.2 m					60.0 m + 2.3 m + 24.1 m					60.0 m + 2.3 m + 31.0 m				
	5°	15°	30°	45°	60°	5°	15°	30°	45°	60°	5°	15°	30°	45°	60°	5°	15°	30°	45°	60°
14.0	13.2																			
16.0	12.8	12.3				8.8														
18.0	11.5	11.2	10.5			8.8					7.8									
20.0	10.4	10.1	9.7	9.2		8.8	8.8				7.8					6.2				
22.0	9.4	9.2	8.9	8.6	8.3	8.8	8.8				7.8					6.2				
24.0	8.2	8.1	8.0	7.9	7.7	8.5	8.2	7.5			7.8	7.4				6.2				
26.0	7.1	7.0	7.0	6.9	6.7	7.5	7.5	7.0			7.5	6.9				6.2				
28.0	5.6	6.1	6.0	6.0	5.9	6.5	6.5	6.5	6.2		6.6	6.5				6.2				
30.0			5.2	5.1	5.1	5.6	5.7	5.7	5.7	5.7	5.8	5.9	5.3			5.8	5.4			
32.0							4.9	5.0	5.0	5.0	5.0	5.1	4.9			5.1	4.9			
34.0								4.3	4.4	4.3		4.5	4.5	4.2		4.4	4.4			
36.0									3.8	3.7			4.1	3.9		4.0	3.6			
38.0													3.5	3.5	3.5	3.5	3.3			
40.0														3.2	3.2		3.0			
42.0															2.7		2.7	2.6		
44.0																	2.4			
46.0																				2.2

MB+HTLJ

Anmerkungen zu den Traglasttabellen Remarks relating to the rating charts Remarques relatives aux tableaux des charges Notas relativas a los graficos de carga

Anmerkungen zu den Traglasttabellen

Die Tragfähigkeiten im Festigkeitsbereich basieren auf DIN 15018 Blatt 2 und Blatt 3 und F.E.M.

Die Tragfähigkeiten im Standsicherheitsbereich entsprechen DIN 15019 Teil 2 / ISO 4305 / EN 13000.

In Abhängigkeit der Auslegerlänge sind bei den Traglasttabellen Windgeschwindigkeiten von max. 10 m/s am Teleskopausleger und max. 7 m/s mit der Auslegerverlängerung zulässig.

Die Tragfähigkeiten sind in metrischen Tonnen angegeben.



Das Gewicht des Lasthakens bzw. der Hakenflasche und weiterer Anschlagmittel ist von der Tragfähigkeit abzuziehen.

Die Tragfähigkeiten für den Teleskopausleger gelten nur bei demontierter Auslegerverlängerung.

Die Ausladung ist der horizontale Abstand von Mitte Drehkranz bis Mitte freihängender, nicht schwingender Last.

Für Lasten über 157 t Zusatzrollen im Rollenkopf erforderlich.

Für bestimmte Lastfälle ist der Einsatz der 2. Hubwinde erforderlich.

	MB	25,1 m	30,2 m	35,3 m
	max. t	> 154,4	> 131,4	> 108,1

Tragfähigkeitsänderungen vorbehalten.

Obige Angaben dienen nur zur Information. Die Bedienungsanleitungen müssen zu Rate gezogen werden, bevor die Maschine in Betrieb genommen wird. Alle hier gemachten Angaben beziehen sich auf die Standard-Ausführung. Jegliche Ausrüstungsveränderungen können die angegebenen Werte beeinflussen.

Remarks relating to the rating charts

The lifting capacities in the structural area are based on DIN 15018 parts 2 and 3 and F.E.M.

The lifting capacities in the stability area are based on DIN 15019 part 2 / ISO 4305 / EN 13000.

Maximum admissible wind velocity for working with telescopic boom is 10 m/sec to 7 m/sec depending at boom length and for working with boom extension 7 m/sec.

The lifting capacities are shown in metric tons.



The weight of load handling devices such as hook blocks, slings, etc., must be considered as part of the load and must be deducted from the lifting capacities.

The lifting capacities for the telescopic boom apply to a crane with no boom extensions being stowed or mounted on the crane.

The working radius is the horizontal distance from the centre of rotation to the centre of the freely suspended non-oscillating load.

Additional sheaves for boom head essential for loads bigger than 157 t.

2. Winch is essential for particular loads.

	MB	25.1 m	30.2 m	35.3 m
	max. t	> 154.4	> 131.4	> 108.1

The lifting capacities are subject to change without prior notice.

The above remarks are for basic information only and the operator's manual must be consulted before operating this crane. All data and performances refer to the standard crane. The addition of optional and other equipment may affect the performance of the crane.

Remarques relatives aux tableaux des charges

Les forces de levage sont conformes aux normes DIN 15018, p. 2 et 3, et F.E.M.

Les forces de levage dans la partie de stabilité au renversement sont conformes aux normes DIN 15019, chap. 2 / ISO 4305 / EN 13000.

Des vitesses de vent sont admissibles entre 7 m/s jusqu'à max 10 m/s en fonction de la longueur de flèche.

Les forces de levage sont données en tonnes métriques.



Le poids du crochet-moufle et de tous les accessoires d'élingage font partie de la charge et sont à déduire des charges indiquées.

Les forces de levage indiquées pour la flèche télescopique s'entendent flèche déposée.

Comme portée, on entend la distance horizontale du centre de la couronne de rotation au centre de la charge librement suspendue et non oscillante.

Pour des charges supérieures à 157 t, des poulies supplémentaires sont nécessaires sur la tête de flèche.

Un 2^{ème} treuil est nécessaire pour les levages spéciaux.

	MB	25,1 m	30,2 m	35,3 m
	max. t	> 154,4	> 131,4	> 108,1

Sauf modification de forces de levage.

Les données ci-dessus servent à titre d'information. Avant la mise en marche de la grue il est conseillé d'étudier les instructions de service. Toutes les données indiquées ci-dessus se réfèrent à la machine de base. Tout changement de l'équipement de la grue peut influencer ces valeurs.

Notas relativas a los graficos de carga

En cuanto a los datos referentes a resistencia, las capacidades de carga están basados sobre las normas DIN 15018, pág. 2 y 3, y F.E.M.

En cuanto a los datos referentes a estabilidad anti-vuelco, las capacidades de carga están basados sobre las normas DIN 15019, Cap. 2 / ISO 4305 / EN 13000.

En independencia a la longitud de la pluma, están toleradas velocidades de viento de entre 7 m/s y 10 m/s.

Las capacidades de carga indicadas en las tablas corresponden a toneladas métricas.



Hay que deducir los pesos del gancho, eslingas y de otros dispositivos para fijación de cargas de los valores indicados en las tablas.

Las capacidades de carga referentes a la pluma telescópica valen solamente si el plumin está desmontada.

Como alcance se entiende la distancia horizontal desde el centro de la corona de giro hasta el centro de la carga suspendida libremente y no oscilante.

Para cargar superiores a 157 t / es necesario poleas adicionales en cabeza de pluma.

Para posibles trabajos es necesario el montaje del 2º cabestrante.

	MB	25,1 m	30,2 m	35,3 m
	max. t	> 154,4	> 131,4	> 108,1

Salvo modificación de capacidades de carga, sin previo aviso.

Los datos arriba indicados sirven solamente para su información. Hay que leer las instrucciones para el uso antes de la puesta en servicio de la máquina. Todos los datos mencionados en las presentes tablas rigen para los modelos standard. Cualquier modificación del equipo montado puede dar lugar a modificaciones de aquellos valores.



WINNER
SALE & RENTAL

Ausrüstung

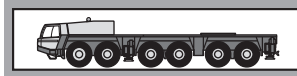

Rahmen Verwindungs- und biegesteife Schweißkonstruktion aus hochfestem Feinkornstahl. Zentralschmieranlage.

Abstützung 4-Punkt-Abstützung, hydraulisch, Bedienungsmöglichkeiten an beiden Seiten des Fahrgestelles und in der Oberwagenkabine.
Abstützbasis 8,5 m (und 8,0 m, 6,8 m, 5,5 m) x 8,9 m.

Motor Mercedes-Benz 8-Zylinder-Dieselmotor OM 502 LA (Euromot III B), wassergekühlt, Leistung 480 kW (653 PS) bei 1800 min⁻¹.
Drehmoment 3000 Nm (306 kpm) bei 1300 min⁻¹.
Motorleistung nach 80 / 1269 / EWG. Kraftstoffbehälter 450 l. AdBlue-Behälter 40 l.

Getriebe ZF-TC-Tronic "Heavy Duty", mechanisches Schaltgetriebe mit Wandlerschaltkupplung und integriertem Intarder, elektronisch-pneumatisch betätigter Trockenkupplung und vollautomatischer Schaltung mit 12 Vorwärts- und 2 Rückwärtsgängen. Power and Economy Modus wählbar.

Antrieb 12 x 8 x 12

Achsen

1. Achse: gelenkt, angetrieben, Differentialsperre quer.
2. Achse: gelenkt, nicht angetrieben.
3. Achse: gelenkt, angetrieben, Differentialsperre längs und quer.
4. Achse: gelenkt, angetrieben, Differentialsperre quer.
5. Achse: gelenkt, angetrieben, Differentialsperre quer.
6. Achse: gelenkt, nicht angetrieben.

Achsaufhängung Hydropneumatische Federung mit Niveauregulierung.

Bremsen Druckluft-Zweikreis-Scheibenbremsanlage. Feststellbremse als Federspeicherbremse an der 3., 4., 5. und 6. Achse wirkend. Intarder mit Bremsomat-Funktion und Konstantdrosselanlage mit Auspuffklappenbremse als Dauerbremse.

Räder 12-fach 445/95 R 25 (16.00 R 25), Breite 3 m.

Lenkung ZF-Servocom-Zweikreis-Hydraulenlenkung mit Notlenkpumpe. Mechanische Lenkung der 1. und 2. Achse.
Im Betriebsmodus "Straße" werden die Achsen 3-6 bis zu einer Geschwindigkeit von 30 km/h elektronisch mitgelenkt.
Ab einer Geschwindigkeit von 30 km/h werden die Achsen 4 und 5 in in Geradeausposition verriegelt und ab einer Geschwindigkeit von 50 km/h zusätzlich die Achsen 3 und 6.

Unterswagenkabine Zwei-Mann-Frontfahrerhaus in Stahl-Kunststoff-Verbund-Konstruktion, Sicherheitsverglasung, luftgefederte Sitze (Fahrersitz mit Heizung) und motorabhängige Warmwasserheizung, Klimaanlage, Radio-CD-Player, Kontroll- und Bedienungselemente für den Fahrbetrieb, Tempomat- / Bremsomat-Funktion.

Elektrische Anlage 24 Volt-Gleichstrom, 2 Batterien, Verdrahtung mit CAN-Bus-Komponenten, integrierte Eigendiagnose Faun-CSS-System, Abstützbeleuchtung.
Die elektrische Anlage entspricht der EG-Norm.

Zusatzrüstung (gegen Mehrpreis)
Anhängerkupplung, motorunabhängige Zusatzheizung mit Motorvorwärmung, ABS, 525/80 R 25 (20.5 R 25) Bereifung / Breite 3,2 m, Reserverad, Sonderlackierung und Beschriftung.
Weitere Zusatzausrüstung auf Anfrage.

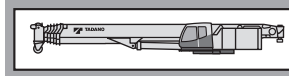

Rahmen Verwindungssteife Schweißkonstruktion mit einer außenverzahnten, dreireihigen Rollendrehverbindung, um 360° unbegrenzt drehbar. Zentralschmieranlage.

Motor Mercedes-Benz 6-Zylinder-Dieselmotor OM 926 LA (Euromot III B), wassergekühlt. Drehzahl ist über Fußpedal stufenlos regelbar, Leistung 195 kW (265 PS) bei 2200 min⁻¹.
Drehmoment 1100 Nm (112 kpm) bei 1200 - 1600 min⁻¹,
Motorleistung nach DIN 6270B / DIN 6271.
Kraftstoffbehälter 230 l. AdBlue-Behälter: 8 l.

Hydraulik System Diesel-hydraulisch mit 3-Kreis-Hydraulik, 1 leistungsgeregelte Axialkolben-Doppelpumpe (hydraulisch verstellbar), 1 Axialkolbenpumpe und 1 Zahnradpumpe, Ölkühler.

Steuerung Zwei 4-fach Kreuzsteuerhebel mit elektrischer Vorsteuerung.

Teleskopausleger Fünfteiliger Teleskopausleger aus hochfestem Feinkornstahl, bestehend aus einem Grundaussleger und 4 Teleskopteilen, 1 Teleskopzylinder, hydraulisch unter Teillast teleskopierbar. 15,0 m - 60,0 m lang. Rollenkopf mit 7 Seilrollen.

Wippwerk Ein Differentialzylinder mit angebautem Senkbremssperrventil.

Hubwerk Axialkolben-Verstell-Motor, Hubwerkstrommel mit eingebautem Planetengetriebe und federbelasteter Hydro-Lamellenbremse mit integriertem Freilauf beim Heben. Hubseil mit 'Super-Stop' Einrichtung.

Drehwerk Axialkolben-Motor, dreistufiges Planetengetriebe mit automatischer Betriebs- und Feststellbremse. Offener Hydraulikkreislauf mit Drehwerk-Freischtaltung.
Drehgeschwindigkeit stufenlos von 0 - 1,1 min⁻¹.

Gegengewicht Gesamtgewicht 98 t teilbar.
Die Bedienung erfolgt mittels einer Fernbedieneinheit.

Oberwagenkabine Großräumige Krankabine in Stahl-Kunststoffausführung mit Sicherheitsverglasung und getönten Scheiben, kippbarem Arbeitsplatz mit verstellbarem, hydraulisch gedämpftem Fahrersitz mit Heizung, motorabhängige und motorunabhängige Warmwasserheizung (mit Motorvorwärmung), Klimaanlage, Radio-CD-Player, Kontroll- und Bedienungselemente sowie graphische LCD-Anzeige für Kranbetrieb.

Elektrische Anlage 24 Volt-Gleichstrom, 2 Batterien.

Sicherheitseinrichtungen 'Lift- und 'Release Adjuster' (automatische Überwachung des Arbeitsradius in Folge Auslegerverformung durch Lasteinwirkung), Lastmomentbegrenzung (LMB), Windmesser, Arbeitsbereichsbegrenzung, Hubendschalter, Windenendschalter, Seilwindendrehmelder, Sicherheitsventile gegen Rohr- und Schlauchbrüche. Sperrventile an Hydraulik-Zylindern.

Zusatzrüstung (gegen Mehrpreis)
Auslegerverlängerungen: Light fixed jib 6,0 m - 24,0 m, Fixed jib 13,5 m - 49,5 m, HTLJ 10,3 m - 31,0 m, Unterflaschen von 12,5 t bis 250 t, Zusatzgegengewicht 20 t / 40 t, 2. Hubwerk, Zusatzölkühler, Sonderlackierung und Beschriftung.
Weitere Zusatzausrüstung auf Anfrage.

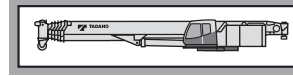
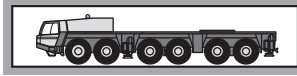

Frame Torsion resistant, welded construction made from high strength, fine-grained steel. Central lubricating system.

Outriggers 4 point, double telescopic hydraulic outriggers with controls on both sides of carrier and in superstructure cab. Outrigger base 8.5 m (8.0 m, 6.8 m, 5.5 m mid extension) x 8.9 m.

Carrier engine Mercedes-Benz 8 cylinder model OM 502 LA (Euromot III B), water-cooled diesel engine. Rated at 480 kW (653 HP) at 1800 min⁻¹. Torque 3000 Nm (306 kpm) at 1300 min⁻¹. Engine rating according to 80 / 1269 / EWG. Fuel tank 450 l. AdBlue-tank 40 l.

Transmission ZF-TC-Tronic HD transmission in "heavy duty" version with torque converter and integrated interarder, electro-pneumatically operated dry-type clutch and automatic gear shifting with 12 forward gears and 2 reverse gears. Power / Economy mode.

Drive 12 x 8 x 12

Axles

1st axle: steered, driven.
2nd axle: steered, not driven.
3rd axle: steered, driven, with longitudinal differential lock.
4th axle: steered, driven.
5th axle: steered, driven.
6th axle: steered, not driven.
All driven axles with transverse differential locks.

Suspension Hydro-pneumatic with levelling adjustment.

Brake system Service disc brakes: dual circuit compressed air system. Parking brake: spring loaded type acting on 3rd, 4th, 5th and 6th axles. Auxiliary brakes: interarder with 'Bremsomat' function, engine exhaust brake and constant throttle engine brake system.

Tyres (12) 445/95 R 25 (16.00 R 25), width 3 m.

Steering system ZF-Servocom, dual circuit hydraulic steering with emergency steering pump, mechanical hydraulically-assisted steering of front two axles. On road mode the 1st and 2nd axle are permanently steered and mechanically connected to the steering gear unit and the 3rd, 4th, 5th and 6th axle are automatically steered, electro-hydraulically, with the 1st and 2nd axles up to a travel speed of 30 km/h and 50 km/h respectively. At a speed of 30 km/h, the 4th and 5th axles are automatically locked in the straight ahead position. At a speed of 50 km/h, the 3rd and 6th axle is automatically locked in the straight ahead position.

Carrier cab Two man full width cab of composite (steel sheet metal and fibre-glass) structure, with safety glass, air-cushioned adjustable seats (driver seat with heater) and engine dependent hot-water heater, air conditioning, radio-CD-player, complete controls and instrumentation for road travel. 'Tempomat- / Bremsomat' function.

Electrical system 24 volt DC system, 2 batteries, CAN-Bus system with Faun CSS integrated self-diagnosis system, outrigger lighting. Electrical system conforms with EEC regulations.

Optional Equipment (at extra charge)

Towing attachment, engine independent additional heater with engine pre-heat, ABS, 525/80 R 25 (20.5 R 25) tyres / width 3.2 m, spare wheel and tyre, special painting and lettering. Further optional equipment available upon request.

Frame Torsion-resistant, all-welded structure of high strength steel. Connected to carrier by triple roller bearing slewing ring with external gearing for 360° continuous rotation. Central lubricating system.

Superstructure engine Mercedes-Benz 6 cylinder model OM 926 LA (Euromot III B), water cooled, diesel engine. PRM infinitely variable via foot pedal, rating 195 kW (265 HP) at 2200 min⁻¹. Torque 1100 Nm (112 kpm) at 1200 - 1600 min⁻¹. Engine rating according to DIN 6270B / DIN 6271. Fuel tank 230 l. AdBlue-tank 8 l.

Hydraulic system Three circuit diesel hydraulic system with 1 power controlled axial piston double pump (hydraulically adjustable) 1 axial piston pump and 1 gear pump, oil cooler.

Controls Electrical, 2 joy-stick levers for simultaneous operation of crane motions.

Telescopic boom 5 sections, made of high tensile, fine-grained steel, consisting of 1 base section and 4 telescoping sections extended by means of a single telescopic cylinder. All telescope sections extendable under partial load. 15.0 m to 60.0 m long. Boom head with 7 sheaves.

Derricking system 1 double acting hydraulic cylinder with integral brake and holding valve.

Main winch Axial piston variable displacement motor, winch drum with integrated planetary reduction and with hydraulically controlled spring-loaded, multiple disc brake. Hoist cable with 'Super-Stop' easy reeving system.

Slewing system Axial piston motor with three-stage planetary gear with automatic service and a parking brake. Open hydraulic circuit with free slewing function. Speed infinitely variable 0 - 1.1 min⁻¹.

Counterweight Total 98 t divisible, assembled and disassembled by hydraulic cylinders operated by remote control.

Superstructure cab Spacious panoramic cab of composite structure with safety (tinted) glass windows, tiltable cockpit with hydraulically cushioned adjustable seat with heater, one engine dependent hot-water heater and one engine independent hot-water heater (with engine pre-heat), air conditioning, radio-CD-player. Complete controls and instrumentation plus LCD graphic display for crane operation.

Electrical system 24 volt DC system, 2 batteries.

Safety devices 'Lift- and Release Adjuster', (automatic radius correction based on boom deflection under load) load moment device (LMD), anemometer, working area limitation, hoist limit switch, lower limit switch and drum turn indicator, safety valves against pipe and hose rupture, holding valves on hydraulic cylinders.

Optional Equipment (at extra charge)

Boom extensions: Light fixed jib 6.0 m - 24.0 m, Fixed jib 13.5 m - 49.5 m, HTLJ 10.3 m - 31.0 m, hook blocks 12.5 t - 250 t, additional counterweight 20 t / 40 t, auxiliary winch, additional oil cooler, special painting and lettering.

Further optional equipment available upon request.

Equipement



Châssis Construction mécanosoudé, en acier à grain fin très rigide, résistant aux flexions et aux torsions. Graissage centralisé.

Calage Dispositif de calage horizontal et vertical en 4 points, entièrement déployable hydrauliquement. Commande des mouvements sur les deux côtés du porteur et depuis la cabine de la superstructure.

Calage 8,5 m (8,0 m, 6,8 m, 5,5 m à mi-extension) x 8,9 m.

Moteur Mercedes Benz diesel 8 cylindres, modèle OM 502 LA (Euromot III B), refroidi par eau, de 480 kW (653 CV) à 1800 min⁻¹. Couple: 3000 Nm (275 kpm) à 1300 min⁻¹. Puissance selon 80 / 1269 / EWG. Capacité du réservoir 450 l. AdBlue-capacité du réservoir 40 l.

Boîte de vitesse Boîte de vitesse ZF-TC-Tronic "Heavy Duty". Boîte mécanique avec convertisseur et Intarder intégré, avec embrayage électro-pneumatique à commande automatique, 12 vitesses AV et 2 vitesses AR. Mode max. performance / économique.

Entraînement 12 x 8 x 12

Essieux

1^{er} essieu: directeur, entraîné, blocage de différentiel transversal.

2^{ième} essieu: directeur, non entraîné.

3^{ième} essieu: directeur, entraîné, blocage de différentiel longitudinal et transversal.

4^{ième} essieu: directeur, entraîné, blocage de différentiel transversal.

5^{ième} essieu: directeur, entraîné, blocage de différentiel transversal.

6^{ième} essieu: directeur, non entraîné.

Suspension Hydro-pneumatique, avec réglage de niveau.

Freins Freins de service à disque: système à double circuit d'air comprimé. Frein destination: avec accumulateurs à ressort agissant sur le 3^{ième}, 4^{ième}, 5^{ième} et 6^{ième} essieu. Freins continus: frein moteur par clapet sur échappement. Ralentisseur hydrodynamique Intarder.

Pneus 12 x 445/95 R 25 (16.00 R 25), largeur 3 m.

Direction Servocom à double circuit, marque ZF avec pompe de direction auxiliaire. Direction mécanique du 1^{er} et 2^{ième} essieu. En mode "route" les essieux 3 - 6 sont directionnels jusqu'à une vitesse de 30 km/h. A partir d'une vitesse de 30 km/h les essieux 4 et 5 sont verrouillés dans une droite et position à partir de 50 km/h les essieux 3 et 6 sont aussi verrouillés.

Cabine Cabine bi-place, construction en matière composite fibre de verre et acier. Vitrage en verre de sécurité, siège conducteur chauffant suspendu hydrauliquement. Chauffage à eau chaude relié au moteur, climatisation, radio-CD-player. Organes de contrôle et de commande pour la conduite. Régulateur de vitesse, système automatique de freinage.

Système électrique 24 V courant continu, 2 batteries, connexion circuit électrique avec CAN-Bus. Equipement avec prise diagnostic et avec interprétation de code erreur de système FAUN CSS, éclairage des points de calage. Conforme aux normes CE.

Equipement supplémentaire (avec supplément de prix)

Attache-remorque, chauffage auxiliaire indépendant du moteur avec préchauffage du moteur, ABS, pneus 525/80 R 25 (20.5 R 25) / largeur 3,2 m, roue de secours, peinture spéciale et inscription.

Autres équipements supplémentaires sur demande.

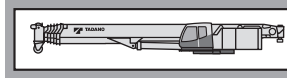

Plate forme Construction mécano-soudée résistante à la torsion. Couronne d'orientation à triple rangée de rouleaux avec denture extérieure pour une rotation à 360° en continu. Graissage centralisé.

Moteur Mercedes Benz diesel 6 cylindres, modèle OM 926 LA (Euromot III B), refroidi par eau.

Réglage du nombre de tours par pédale, de 195 kW (265 CV) à 2200 min⁻¹. Couple: 1100 Nm (112 kpm) à 1200 - 1600 min⁻¹.

Puissance selon DIN 6270B / DIN 6271.

Capacité du réservoir 230 l.

AdBlue-capacité du réservoir 8 l

Système hydraulique Diesel-hydraulique à 3 circuits, 1 double pompe à pistons axiaux à régulation de puissance (à réglage hydraulique) 1 pompe à pistons axiaux et 1 pompe à engreages, refroidisseur d'huile.

Commande 2 manipulateurs à commande en croix (4 sens), assistés électriquement.

Flèche télescopique 1 flèche de base et 4 éléments télescopiques en acier fin, 1 vérin télescopique, hydrauliquement télescopable avec charge partielle. Longueur de 15,0 m à 60,0 m. Tête de flèche avec 7 poulies.

Mécanisme de relevage 1 vérin différentiel muni de clapet de freinage de descente.

Mécanisme de levage Moteur hydraulique à cylindrée variable, tambour de levage avec boîte planétaire incorporée, frein d'arrêt à disques multiples à ressort, libéré lors du levage. Câble de levage avec dispositif 'Super-Stop'.

Orientation Moteur hydraulique avec entraînement planétaire à 3 gammes avec frein de stationnement automatique. Circuit ouvert avec déconnexion de l'orientation.

Vitesse de rotation 0 à 1,1 min⁻¹ en continu.

Contrepoids Poids total 98 t divisible, assembles et démantelés grâce à des vérins hydrauliques télécommandés.

Cabine du grutier Cabine de grue spacieuse, construction en matière combinée acier / synthétique, avec vitrage de sécurité en verre teinté, siège chauffant, réglable et amorti hydrauliquement, inclinable avec instruments de commande, chauffage à eau chaude dépendant et indépendant du moteur (avec préchauffage du moteur), climatisation, radio-CD-player, éléments de commande et de contrôle avec affichage digital pour travaux.

Système électrique 24 V courant continu, 2 batteries.

Dispositifs de sécurité 'Lift- et 'Release Adjuster', limiteur de charge (CEC), anémomètre, limitation de zone de travail, interrupteur de fin de course de levage et de treuil, indicateur du nombre de tours, soupapes de sécurité contre ruptures des conduites et flexibles, clapets sur verins hydraulique.

Equipement supplémentaire (avec supplément de prix)

Fléchette: Light fixed jib 6,0 m - 24,0 m, Fixed jib 13,5 m - 49,5 m, HTLJ 10,3 m - 31,0 m, moufles de 12,5 t à 250 t, 2^{ième} treuil de levage, contrepoids additionnel de 20 t / 40 t, refroidisseur d'huile supplémentaire, peinture spéciale et inscription.

Autres équipements supplémentaires sur demande.

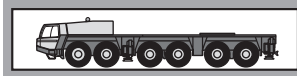

Chasis portante Construcción en acero de alta resistencia soldado, resistente a la torsión y flexión. Engrase centralizado.

Estabilizadores Estabilizadores hidráulicos de 4 puntos. Posibilidad de manejo desde ambos lados del chasis y desde la cabina de la grúa. Base de apoyo 8,5 m (variante 8,0 m, 6,8 m, 5,5 m) x 8,9 m.

Motor Mercedes Benz 8 cilindros; OM 502 LA (Euromot III B), refrigerado por agua.
Potencia de 480 kW (653 CV) a 1800 min⁻¹; par 3000 Nm (275 kpm) a 1300 min⁻¹. Potencia de motor según 80 / 1269 / EWG. Depósito de combustible de 450 l. Depósito AdBlue 40 l.

Transmisión Transmisión mecánica modelo ZF-TC Tronic "Heavy Duty". Con convertidor y embrague de puente con Intarder integrado, accionamiento electro-neumático. Embrague seco cambio automático con 12 marchas delanteras + 2 traseras. Modo rendimiento máximo / económico.

Tracción 12 x 8 x 12

Ejes

- 1° eje: direccional, accionado, con bloqueo diferencial transversal.
- 2° eje: direccional.
- 3° eje: direccional, accionado, con bloqueo diferencial transversal + longitudinal.
- 4° eje: direccional, accionado, con bloqueo diferencial transversal.
- 5° eje: direccional, accionado, con bloqueo diferencial transversal.
- 6° eje: direccional.

Suspensión Suspensión hidroneumática con regulación de nivel.

Sistemas de frenos Accionamiento neumático con frenos de disco. Frenos de estacionamiento tipo muelles cargados, en los ejes 3°, 4°, 5° y 6°. Intarder con sistema automático de frenado continuo. Sistema de estrangulador sobre el escape.

Neumáticos 12 x 445/95 R 25 (16.00 R 25), ancho 3 m.

Dirección Dirección hidráulica ZF Servocom de doble circuito y bomba auxiliar de dirección. Dirección mecánica en los ejes 1° y 2°. Ejes 3° - 6° en servicio modo circulación "carretera" acompañan la dirección hasta una velocidad de 30 km/h. A partir de 30 km/h los ejes 4° - 5° se bloquean y quedan sin dirección. A partir de 50 km/h quedan sin dirección los ejes 3° - 6°.

Cabina Cabina para dos personas, en construcción de acero de fibra de vidrio. Cristales de seguridad, asiento con suspensión neumática y calefactado. Calefacción por agua caliente del motor, climatización, radio-CD-player. Elementos de control e instrumentación para la circulación por carretera. Regulador de velocidad, sistema automático de frenado.

Sistema eléctrico Sistema de 24 V c.c. con dos baterías, conexiones eléctricas integradas en el sistema CAN-Bus, sistema integrado de diagnóstico Faun-CSS. Faros de trabajo en los estabilizadores. El sistema eléctrico cumple la normativa CEE.

Equipo adicional (con suplemento de precio)

Embrague de remolque, calefacción adicional con precalefacción del motor, ABS, neumáticos 525/80 R 25 (20.5 R 25) / ancho 3,2 m, rueda de repuesto, pintura especial y rotulación.

Otros equipamientos sobre pedido.

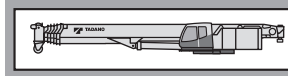

Superestructura Construida en aceros soldados, resistente a la torsión. Corona de giro de dientes externos con un giro de 360°.

Motor Mercedes Benz 6 cilindros modelo OM 926 LA (Euromot III B), refrigerado por agua. Las revoluciones aumentan de forma gradual accionado por el acelerador. Potencia 195 kW (265 Cv) a 2200 min⁻¹. Par 1100 Nm (112 kpm) a 1200 -1600 min⁻¹. Potencia de motor según normativa DIN 6270B / DIN 6271. Depósito de combustible 230 l; depósito de AdBlue 8 l.

Sistema hidráulico Sistema hidráulico de 3 circuitos, 1 bomba doble de pistones axiales (regulada hidráulicamente) 1 bomba axial y 1 bomba dentada. Enfriador de aceite.

Mandos 2 palancas de control de tipo joy-stick para movimientos simultáneos de la grúa (4 direcciones), asistidos eléctricamente.

Pluma telescópica Pluma telescópica compuesta de 5 tramos de acero de alta resistencia, 1 trama base + 4 tramos telescópicos, extensibles bajo carga. Longitud 15,0 m - 60,0 m. Cabeza de pluma con 7 poleas.

Elevación de pluma Cilindro telescópico con válvula de anti-caída.

Cabrestante principal Motor de pistones axiales variable. Cabestrante con reducción de planetarios y frenos de disco con sistema libre de elevación. Cable de elevación con sistema fácil de guiado 'Super-Stop'.

Sistema de giro Motor hidráulico de pistones axiales con reducción planetaria de tres etapas. Circuito hidráulico abierto con posibilidad con reductor posición veleta. Velocidad de giro gravable desde 0 - 1,1 min⁻¹.

Contrapeso Peso total 98 t divisible. Accionamiento mediante mando a distancia.

Cabina de la grúa Cabina espaciosa y confortable en construcción de acero de fibra de vidrio. Con cristales tintados de seguridad. Asiento de conductor amortiguado hidráulicamente, calefactado. Calefacción independiente, climatización, radio-CD-player. Controles e instrumentación a sí como display digital LCD para la operación de la grúa.

Sistema eléctrico Sistema de 24 V c.c. con dos baterías.











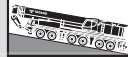
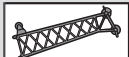











Medidas de seguridad Sistema de 'Lift- and Release Adjuster' limitación de momentos de carga (LMC). Anemómetro limitación de área de trabajo. Final de carrera, control de cabestrante, indicador de vueltas de cabestrante, válvulas de seguridad contra rotura de tuberías y latiguillos. Válvulas de cierre en cilindros hidráulicos.

Equipo adicional (con suplemento de precio)

Plumin: Light fixed jib 6,0 m - 24,0 m, Fixed jib 13,5 m - 49,5 m, HTLJ 10,3 m - 31,0 m, Pastecas desde 12,5 t - 250 t, 2° cabrestante, enfriador adicional, contrapeso adicional de 20 t / 40 t, pintura especial y rotulación.

Otros equipamientos sobre pedido.

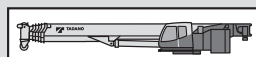
Symbolerklärung
 Symbols
 Glossaire des symboles
 Glosario de símbolos

	Teleskopausleger Telescopic boom Flèche télescopique Pluma telescópica		Steigfähigkeit Gradeability Abtitude en pente Superacion de pendientes
	Auslegerverlängerung Boom extension Fléchette Plumín		Gelände Off road Tout-terrain Todo terreno
	Auslegerverlängerung hydraulisch Boom extension hydraulically Fléchette hydrauliquement Plumín hidráulicamente		Straße On road En route En carretera
	Auslegerverlängerung HTLJ Boom extension HTLJ Fléchette HTLJ Plumín HTLJ		Geschwindigkeiten Oberwagen Superstructure speeds Vitesses du partie tournante Velocidades de la superestructura
	Abstützung Outriggers Calage Estabilizadores		Hubwerk Main winch Mécanisme de levage Cabrestante principal
	Drehwerk Slewing system Orientation Sistema de giro		2. Hubwerk Auxiliary winch 2 ^{ème} treuil de levage 2 ^o cabrestante
	Gegengewicht Counterweight Contrepoids Contrapeso		Wippwerk Derricking system Mécanisme de relevage Elevación de pluma
	Siehe Seite 40 As on Page 40 Voyez la page 40 Véase la pagina 40		Teleskopieren Boom telescoping Télescopage de flèche Telescopaje de pluma
	Räder / Größe Tyres / Size Pneus / Largeur Neumáticos / Tamaño de ruedas		Ausladung Radius Portée Radio
	Achslast Axle load Charge à l'essieu Carga por eje		Ausladung Radius Portée Radio
	Unterflasche / Hakengeschrir Hook block / Swivel hook Moufle / Elingues Gancho / Gancho de bola		Unterwagen Carrier châssis chasis
	Geschwindigkeiten Unterwagen Carrier speeds Vitesses du châssis Velocidades del chasis		Oberwagen Superstructure partie tournante superestructura
	Getriebe / Gang Transmission / Gear Boîte de vitesse / Rapport Transmisión / Marchas		



WINAK
SALE & RENTAL

WIMAK
SALE & RENTAL



TADANO FAUN GmbH

Faunberg 2, 91207 Lauf a. d. Pegnitz, Germany
Phone: +49-9123-185-0 Fax: +49-9123-3085
<http://www.tadanofaun.de> E-mail: info@tadanofaun.de

TADANO LTD. (International Division)

4-12, Kamezawa 2-chome, Sumida-ku Tokyo 130-0014, Japan
Phone: 81-3-3621-7750 Fax: 81-3-3621-7785
<http://www.tadano-global.com> E-mail: tdnihq@tadano.co.jp