

GR-150XL-3



15 Ton Capacity (13.6 Metric Tons)

SPEC. SHEET NO. TAC-GR-150-3-0-0102-03312019

HYDRAULIC ROUGH TERRAIN CRANE

DIMENSIONS

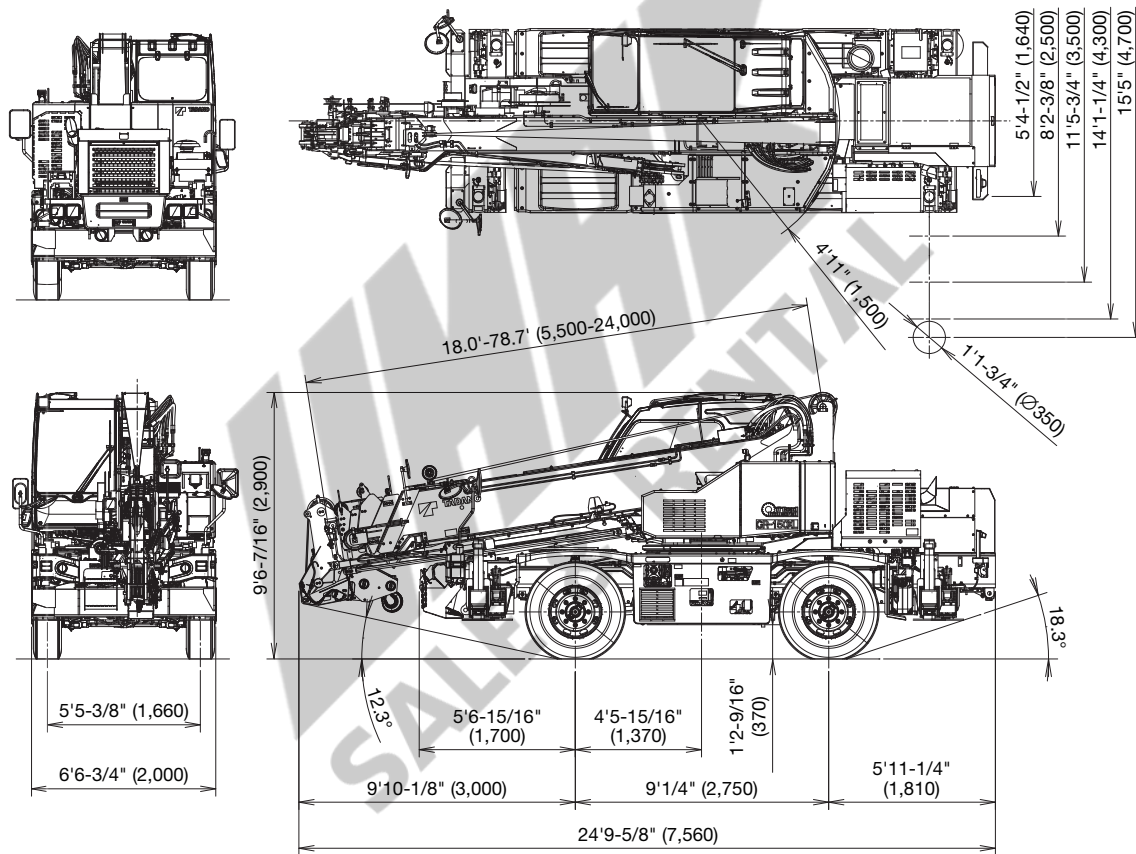

Note: In this external views, a few equipment are included.
() Reference dimensions in mm.

GENERAL DIMENSIONS

	Feet	Meter
Turning radius (315/80R22.5 Tires)		
4 wheel steer	14' 5-1/4"	4.4
2 wheel steer	24' 11-1/8"	7.6
Tail swing of counterweight	4' 11"	1.5

	Feet	Meter
Overall length	approx. 24' 9-5/8"	7.56
Overall width	approx. 6' 6-3/4"	2.00
Overall height	approx. 9' 6-7/16"	2.90

CRANE SPECIFICATIONS

BOOM

6 section full power partially synchronized telescoping boom of rectangular box construction with 3 sheaves at boom head. The synchronization system consists of 2 telescope cylinders, extension cables and retraction cables. Hydraulic cylinder fitted with holding valve. An easily removable wire rope guard, rope dead end provided on the left side of boom head. Boom telescope sections are supported by wear pads both vertically and horizontally.

Fully retracted length.....	18.0' (5.5 m)
Fully extended length.....	78.7' (24.0 m)
Extension speed.....	60.6' (18.5 m) in 56 s
Root diameter.....	10-1/2" (0.266 m)

BOOM ELEVATION

By a double acting hydraulic cylinder with holding valve. Combination controls for hand or foot operation. Automatic speed reduction and slow stop function.

Boom angle.....	-9°– 82°
Boom raising speed.....	-9° to 82° in 29 s

JIB

2 stage extension type, offset angle (5°-60°) by tilt cylinder. Single sheave at jib head. Box type top section telescopes from box type base section which stows under base boom section.

Length.....	11.8' (3.6 m), 18' (5.5 m)
Offset.....	5°-60°
Root diameter.....	10-1/2" (0.266 m)

ANTI-TWO-BLOCK DEVICE

Pendant type over-winding cut out device with audio-visual (FAILURE icon/BUZZER) warning system.

SLEWING

Hydraulic axial piston motor driven through planetary slewing speed reducer. Continuous 360° full circle slewing on ball bearing.

Equipped with manually locked/released slewing brake. A 360° positive slewing lock for pick and carry and travel modes. Slewing speed..... 2.6 min⁻¹ {rpm}

WINCH

Variable speed type with grooved drum driven by hydraulic axial piston motor through speed reducer. Power load lowering and raising.

Equipped with automatic brake (neutral brake) and counterbalance valve. Equipped with drum rotation indicator.

DRUM

Root diameter x wide.....	12-1/4" (0.308 m) x 12-5/16" (0.312 m)
Wire rope diameter x length.....	9/16" (14.0 mm) x 443' (135 m)
Drum capacity.....	573-8' (174.9 m), 7 layers
Maximum permissible line pull.....	7,500 lbs (3,400 kg)
Maximum line speed.....	407 F.P.M (124 m/min) at the 4th layer

WIRE ROPE

Filler or warrington seal wire (spin-resistant), extra improved plow steel, preformed, independent wire rope core, right regular lay. 9/16" (14.0 mm) IWRC 6 x WS (31) class

HOOK BLOCKS

15.0 ton (13.6 metric ton)
2 sheaves with swivel hook and safety latch
3.5 ton (3.2 metric ton)
Weighted hook with swivel and safety latch

HYDRAULIC SYSTEM PUMPS

2 variable piston pumps for crane functions. Tandem gear pump for steering, slewing and optional equipment. Powered by carrier engine. Pump disconnect for crane is engaged/disengaged by rotary switch from operator's cab.

CONTROL VALVES

Electrically controlled Multiple valves actuated by pilot pressure with integral pressure relief valves.

RESERVOIR

44.6 gallon (169 lit.) capacity. External sight level gauge.

FILTRATION

BETA10=10 return filter, full flow with bypass protection, located inside of hydraulic reservoir. Accessible for easy replacement.

OIL COOLER - Air cooled fan type.

CAB AND CONTROLS

Both crane and drive operations can be performed from one cab mounted on rotating superstructure.

Right side, 1 man type, steel construction with sliding door access and safety glass windows opening at side. Door window is powered control. Windshield glass window and roof glass window are shatter-resistant. Wiper and washer (front windshield and roof window). Tinted safety glass and sun visor. Tilt-telescoping steering wheel. Adjustable control lever stand for slewing, boom elevating, boom telescoping and winch. Control lever stand can change neutral positions and tilt for easy access to cab. Foot operated controls: boom elevating, boom telescoping, service brake and engine throttle. 3 way adjustable operator's suspension seat with high back, headrest and armrest. Engine throttle knob. Hot water cab heater and air conditioning.

Dash-mounted Instruments panel, Multi Function Display, Starter switch (engine start/stop), Drive mode selector switch, Parking brake switch, Steering mode selector switch, Power window switch, PTO switch (pump engaged/disengaged), Air conditioning control panel.

Instruments panel -

Speedometer, Tachometer, Odo/trip/hour meter. Torque converter oil temperature gauge, Water temperature gauge, Air pressure gauge, Fuel gauge.

Multi Function Display -

DEF level gauge, DPF level gauge, Fuel consumption monitor.

CRANE SPECIFICATIONS

TADANO electronic Load Moment Indicator system (AML-E) including:

- Control lever lockout function with audible and visual pre-warning
- Number of parts of line
- Boom position indicator
- Outrigger state indicator
- Slewing angle
- Boom angle / boom length / jib offset angle / jib length / load radius / rated lifting capacities / actual loads read out
- Potential lifting height
- Ratio of actual load moment to rated load moment indication
- Permissible load
- Automatic Speed Reduction and Slow Stop function on boom elevation and slewing
- Working condition register switch
- Load radius / boom angle / tip height / slewing range preset function
- External warning lamp

- Tare function
- Main hydraulic oil pressure
- Fuel consumption monitor
- Drum rotation indicator (audible and visible type)
- On rubber indicator
- Flood lamp switch
- Hydraulic oil temperature

TADANO AML-E monitors outrigger extended length and automatically programs the corresponding "RATED LIFTING CAPACITIES" table

Operator's left hand console includes transmission gear selector and sight level bubble, and outrigger control panel, power supply socket, telescoping lever control selector.

NOTE: Each crane motion speed is based on unladen conditions.

CARRIER SPECIFICATIONS

TYPE

Rear engine, right-hand drive, driving axle 2-way selected type by manual switch, 4x2 front drive, 4x4 front and rear drive.

FRAME

High tensile steel, all welded mono-box construction.

ENGINE

Model	HINO JO5EVA-TDFC [Tier4]
Type	Direct injection diesel
No. of cylinders	4
Combustion	4 cycle, turbo charged and intercooled
Bore x Stroke, in. (mm)	4.409 x 5.118 (112 x 130)
Displacement, cu. in. (liters)	312.6 (5.123)
Start assisting device	24 volt glow plug type
Air cleaner	Dry type, replaceable element
Oil filter	Combined use of all-flow and partial flow paper filters (Spin-on type)
Fuel filter	All-flow paper filter (Element-replacement type)
Fuel tank, gal. (liters)	50 (189), right side of carrier
Cooling	Liquid pressurized, recirculating by-pass
Radiator	Fin and tube core, thermostat controlled
Fan, in. (mm)	Inhalation type, 10-blade, 20.5 (520) dia.
Starting	24 volt
Charging	24 volt system, negative ground
Battery	2-80 amp. Hour
Compressor, air, CFM (l/min)	13.6 (385) at 2,500 min ⁻¹
Output, Max. HP (kW)	without fan NET 172 (129) at 2,500 min ⁻¹
Torque, Max. ft-lb (kgm)	395 (55) at 1,600 min ⁻¹
Capacity, gal. (liters)	
Cooling water	2.5 (9.5)
Lubrication	2.8 (10.7)
Fuel	50 (189)
DEF	5 (19)

TRANSMISSION

Electronically controlled full automatic transmission. Torque converter driving full power shift with driving axle selector. 6 forward and 2 reverse speeds, constant mesh.

- 2 speeds - high range - 2-wheel drive; 4-wheel drive
- 3 speeds - low range - 4-wheel drive

TRAVEL SPEED - 25 mph (41 km/h)

GRADE ABILITY (tan θ) - 51% (at stall), 36%

* Machine should be operated within the limit of engine crankcase design.

AXLE

Front: Full floating type, steering and driving axle with planetary reduction.

Rear: Full floating type, steering and driving axle with planetary reduction.

STEERING

Hydraulic power steering controlled by steering wheel. 4 steering modes available: 2 wheel front, 2 wheel rear, 4 wheel coordinated and 4 wheel crab.

SUSPENSION

Front: Semi-elliptic leaf springs with hydraulic lockout device. Rear: Semi-elliptic leaf springs with hydraulic lockout device.

BRAKE SYSTEMS

Service: Air over hydraulic disc brakes on all 4 wheels. Parking/Emergency: Spring applied-air released brake acting on input shaft of front axle. Auxiliary: Electro-pneumatic operated exhaust brake.

TIRES - 315/80R22.5 (OR) Air pressure: 850 kPa

OUTRIGGERS

4 hydraulic, beam and jack outriggers. Vertical jack cylinders equipped with integral holding valve. Each outrigger beam and jack is controlled independently from cab. Beams extend to 15'5" (4.7 m) center-line and retract to within 5'4-1/2" (1.64 m) overall width with floats. Outrigger jack floats are attached thus eliminating the need of manually attaching and detaching them. Controls and sight bubble located in superstructure cab. 4 outrigger extension lengths are provided with corresponding "RATED LIFTING CAPACITIES" for crane duty in confined areas.

Min. Extension	5'4-1/2" (1.64 m) center to center
Mid. Extension	8'2-3/8" (2.5 m) center to center
Mid. Extension	11'5-3/4" (3.5 m) center to center
Mid. Extension	14'1-1/4" (4.3 m) center to center
Max. Extension	15'5" (4.7 m) center to center
Float size (Diameter)	1'1-3/4" (0.35 m)

STANDARD EQUIPMENT

- Telematics (machine data logging and monitoring system) with HELLO-NET via internet
- Eco mode system
- Positive control
- Emergency steering system
- Transmission neutral position engine start
- Overshift prevention
- Parking brake travel warning
- Tilt-telescope steering wheel
- LED head lamp
- Fenders
- Air dryer
- Water separator with filter (high filtration)
- Air cleaner dust indicator
- Full instrumentation package
- Towing hooks-Front and rear
- External warning lamp
- Tire inflation kit
- Tool storage compartment
- Rear view camera
- Left-front camera
- Multi function display

HOISTING PERFORMANCE

LINE SPEEDS AND PULLS

Layer	12-1/4" (0.308 m) drum					
	Line speeds ¹				Line pulls Available ²	
	Low		High		Low	
	F.P.M	m/min	F.P.M	m/min	Lbs.	kg
1st	197	60	331	101	13,400	6,080
2nd	210	64	354	108	12,400	5,640
3rd	226	69	381	116	11,600	5,260
4th	243	74	407	124	10,800	4,940
5th	256	78	433	132	10,200	4,640
6th	272	83	459	140	9,600	4,380
7th ³	289	88	509	155	8,650	3,920

- Maximum permissible line pull wire strength.
9,700 lbs (4,400 kg) with 6x31 class rope.

- ¹ Line speed based only on hook block, not loaded.
- ² Developed by machinery with each layer of wire rope, but not based on rope strength or other limitations in machinery or equipment.
- ³ Seventh layer of wire rope are not recommended for hoisting operations.

DRUM WIRE ROPE CAPACITIES

Wire rope layer	Drum grooved lagging			
	9/16" (14.0 mm) wire rope			
	Rope per layer		Total wire rope	
	Feet	m	Feet	m
1	66.6	20.3	66.6	20.3
2	71.5	21.8	138.1	42.1
3	76.8	23.4	214.9	65.5
4	82.0	25.0	296.9	90.5
5	87.2	26.6	384.1	117.1
6	92.2	28.1	476.4	145.2
7	97.4	29.7	573.8	174.9

DRUM DIMENSIONS

	inch	mm
Root diameter	12-1/4	308
Length	12-5/16	312
Flange diameter	20-1/2	520

GR-150XL WORKING RANGE CHART

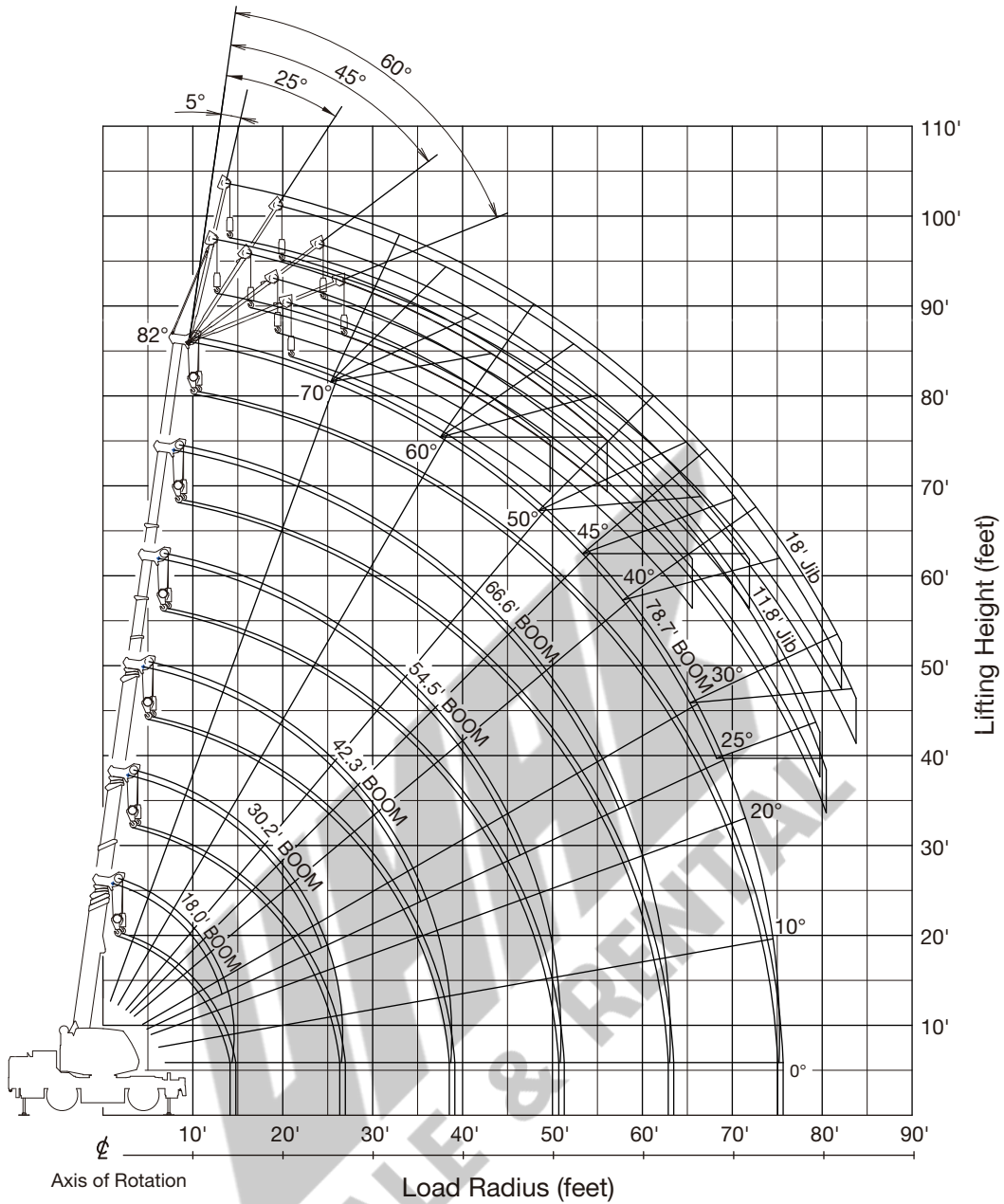

BOOM (4 parts of line)

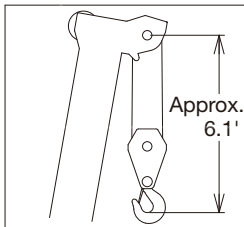

BOOM (1 part of line)

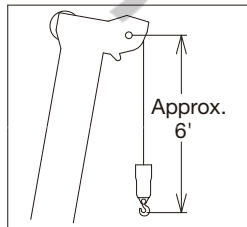

JIB

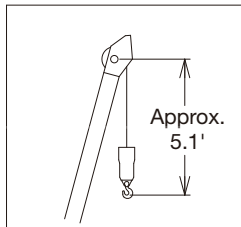

Boom Length in Feet

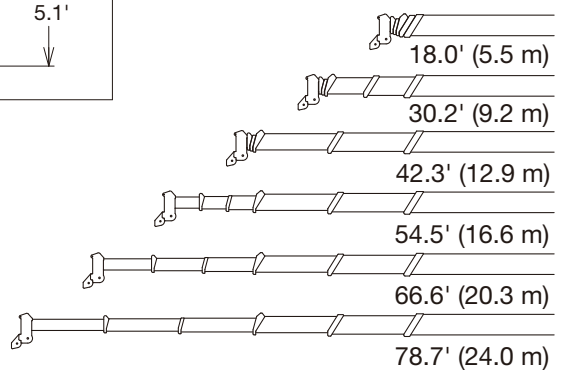

NOTE: 1. Boom and jib geometry shown are for unloaded condition and machine standing level on firm supporting surface. Boom deflection and subsequent radius and boom angle change must be accounted for when applying load to hook.

GR-150XL RATED LIFTING CAPACITIES (IN POUNDS)

4 PARTS OF LINE

ON OUTRIGGERS FULLY EXTENDED 15' 5" (4.7 m) SPREAD 360° ROTATION												
A	18.0'		30.2'		42.3'		54.5'		66.6'		78.7'	
	C	(5.5 m)	C	(9.2 m)	C	(12.9 m)	C	(16.6 m)	C	(20.3 m)	C	(24.0 m)
4	72.2	30,000	80.4	16,100								
5	68.8	30,000	78.5	16,100	82.0	16,100						
6	65.5	27,600	76.6	16,100	80.9	16,100						
8	58.0	23,800	72.5	16,100	78.3	15,700	81.1	12,100				
10	49.3	19,300	68.6	16,100	75.6	15,200	79.0	12,100	81.6	11,200		
12	38.5	15,800	64.3	15,200	72.7	14,000	77.0	12,100	79.9	10,300	81.7	7,050
15			57.5	11,900	68.4	11,500	73.8	11,300	77.4	9,300	79.8	7,050
20			44.5	8,400	60.7	8,200	68.2	8,500	73.0	7,800	75.9	6,600
25			25.9	6,250	52.2	6,000	62.3	6,400	68.5	6,100	72.4	5,600
30					42.6	4,700	56.2	5,100	63.8	5,000	68.7	4,700
35					30.6	3,400	49.2	3,800	58.7	4,000	64.6	3,800
40							41.3	3,000	53.2	3,200	60.3	3,100
45							31.6	2,300	47.2	2,600	55.7	2,500
50									40.5	2,000	50.8	2,100
55									32.7	1,600	45.7	1,700
60									22.1	1,300	39.9	1,450
65											33.4	1,150
70											25.3	900
D	0°											

LIFTING CAPACITIES AT ZERO DEGREE BOOM ANGLE ON OUTRIGGERS FULLY EXTENDED 15' 5" (4.7 m) SPREAD 360° ROTATION												
A	18.0'		30.2'		42.3'		54.5'		66.6'		78.7'	
	B	(5.5 m)	B	(9.2 m)	B	(12.9 m)	B	(16.6 m)	B	(20.3 m)	B	(24.0 m)
0°	14.2	12,800	26.8	5,600	39.3	2,700	51.4	1,500	63.5	1,000	75.8	700

1 PART OF LINE

ON OUTRIGGERS FULLY EXTENDED 15' 5" (4.7 m) SPREAD 360° ROTATION												
A	18.0'		30.2'		42.3'		54.5'		66.6'		78.7'	
	C	(5.5 m)	C	(9.2 m)	C	(12.9 m)	C	(16.6 m)	C	(20.3 m)	C	(24.0 m)
4	75.9	7,050	81.7	7,050								
5	72.6	7,050	79.9	7,050								
6	69.1	7,050	78.0	7,050	81.5	7,050						
8	61.6	7,050	74.1	7,050	78.8	7,050	81.4	7,050				
10	53.5	7,050	70.1	7,050	76.3	7,050	79.4	7,050	81.6	7,050		
12	43.7	7,050	66.0	7,050	73.5	7,050	77.4	7,050	80.0	7,050	81.9	5,700
15			59.4	7,050	69.2	7,050	74.2	7,050	77.6	7,050	79.9	5,700
20			47.0	7,050	61.9	7,050	68.9	7,050	73.5	7,050	76.5	5,700
25			30.4	6,250	53.7	6,000	63.2	6,400	69.0	6,100	73.0	5,600
30					44.6	4,700	57.1	5,100	64.4	5,000	69.2	4,700
35					33.3	3,400	50.5	3,800	59.5	4,000	65.2	3,800
40							42.9	3,000	54.1	3,200	60.9	3,100
45							33.7	2,300	48.2	2,600	56.4	2,500
50									41.8	2,000	51.6	2,100
55									34.3	1,600	46.6	1,700
60									24.5	1,300	41.2	1,450
65											34.7	1,150
70											27.0	900
D	0°											

LIFTING CAPACITIES AT ZERO DEGREE BOOM ANGLE ON OUTRIGGERS FULLY EXTENDED 15' 5" (4.7 m) SPREAD 360° ROTATION												
A	18.0'		30.2'		42.3'		54.5'		66.6'		78.7'	
	B	(5.5 m)	B	(9.2 m)	B	(12.9 m)	B	(16.6 m)	B	(20.3 m)	B	(24.0 m)
0°	15.1	7,000	27.8	5,300	40.2	2,500	52.3	1,500	64.4	1,000	76.6	700

- A: Boom length in feet
- B: Load radius in feet
- C: Loaded boom angle (°)
- D: Minimum boom angle (°) for indicated boom length (no load)

GR-150XL RATED LIFTING CAPACITIES (IN POUNDS)

4 PARTS OF LINE

ON OUTRIGGERS MID EXTENDED 14' 1-1/4" (4.3 m) SPREAD 360° ROTATION												
B	18.0'		30.2'		42.3'		54.5'		66.6'		78.7'	
	C	(5.5 m)	C	(9.2 m)	C	(12.9 m)	C	(16.6 m)	C	(20.3 m)	C	(24.0 m)
4	72.2	30,000	80.4	16,100								
5	68.8	30,000	78.5	16,100	82.0	16,100						
6	65.5	27,600	76.6	16,100	80.9	16,100						
8	58.0	23,800	72.5	16,100	78.3	15,700	81.1	12,100				
10	49.3	19,300	68.6	16,100	75.6	15,200	79.0	12,100	81.6	11,200		
12	38.5	15,800	64.3	15,200	72.7	14,000	77.0	12,100	79.9	10,300	81.7	7,050
15			57.5	11,900	68.4	11,500	73.8	11,300	77.4	9,300	79.8	7,050
20			44.5	8,400	60.7	8,200	68.2	8,500	73.0	7,800	75.9	6,600
25			25.9	6,250	52.2	6,000	62.3	6,400	68.5	6,100	72.4	5,600
30					42.7	4,000	56.1	4,600	63.6	4,800	68.7	4,700
35					30.6	2,800	49.2	3,300	58.7	3,600	64.6	3,700
40							41.3	2,400	53.3	2,700	60.3	2,800
45							31.6	1,800	47.1	2,000	55.6	2,100
50									40.4	1,500	50.6	1,600
55									32.6	1,100	45.5	1,250
60									22.0	800	39.8	950
65											33.3	700
D	0°											26°

LIFTING CAPACITIES AT ZERO DEGREE BOOM ANGLE ON OUTRIGGERS MID EXTENDED 14' 1-1/4" (4.3 m) SPREAD 360° ROTATION											
C	18.0'		30.2'		42.3'		54.5'		66.6'		
	B	(5.5 m)	B	(9.2 m)	B	(12.9 m)	B	(16.6 m)	B	(20.3 m)	
0°	14.2	12,800	26.8	5,400	39.3	2,000	51.4	1,100	63.5	600	

1 PART OF LINE

ON OUTRIGGERS MID EXTENDED 14' 1-1/4" (4.3 m) SPREAD 360° ROTATION												
B	18.0'		30.2'		42.3'		54.5'		66.6'		78.7'	
	C	(5.5 m)	C	(9.2 m)	C	(12.9 m)	C	(16.6 m)	C	(20.3 m)	C	(24.0 m)
4	75.9	7,050	81.7	7,050								
5	72.6	7,050	79.9	7,050								
6	69.1	7,050	78.0	7,050	81.5	7,050						
8	61.6	7,050	74.1	7,050	78.8	7,050	81.4	7,050				
10	53.5	7,050	70.1	7,050	76.3	7,050	79.4	7,050	81.6	7,050		
12	43.7	7,050	66.0	7,050	73.5	7,050	77.4	7,050	80.0	7,050	81.9	5,700
15			59.4	7,050	69.2	7,050	74.2	7,050	77.6	7,050	79.9	5,700
20			47.0	7,050	61.9	7,050	68.9	7,050	73.5	7,050	76.5	5,700
25			30.4	6,250	53.7	6,000	63.2	6,400	69.0	6,100	73.0	5,600
30					44.6	4,000	57.1	4,600	64.4	4,800	69.2	4,700
35					33.3	2,800	50.5	3,300	59.4	3,600	65.1	3,700
40							42.9	2,400	54.1	2,700	60.8	2,800
45							33.7	1,800	48.2	2,000	56.2	2,100
50									41.7	1,500	51.5	1,600
55									34.2	1,100	46.4	1,250
60									24.4	800	40.8	950
65											34.6	700
D	0°											28°

LIFTING CAPACITIES AT ZERO DEGREE BOOM ANGLE ON OUTRIGGERS MID EXTENDED 14' 1-1/4" (4.3 m) SPREAD 360° ROTATION											
C	18.0'		30.2'		42.3'		54.5'		66.6'		
	B	(5.5 m)	B	(9.2 m)	B	(12.9 m)	B	(16.6 m)	B	(20.3 m)	
0°	15.1	7,000	27.8	5,000	40.2	1,800	52.3	1,100	64.4	500	

- A: Boom length in feet
- B: Load radius in feet
- C: Loaded boom angle (°)
- D: Minimum boom angle (°) for indicated boom length (no load)

GR-150XL RATED LIFTING CAPACITIES (IN POUNDS)

4 PARTS OF LINE

ON OUTRIGGERS MID EXTENDED 11' 5-3/4" (3.5 m) SPREAD 360° ROTATION												
A	18.0'		30.2'		42.3'		54.5'		66.6'		78.7'	
	C	(5.5 m)	C	(9.2 m)	C	(12.9 m)	C	(16.6 m)	C	(20.3 m)	C	(24.0 m)
4	72.2	30,000	80.4	16,100								
5	68.8	30,000	78.5	16,100	82.0	16,100						
6	65.5	27,600	76.6	16,100	80.9	16,100						
8	58.0	23,800	72.5	16,100	78.3	15,700	81.1	12,100				
10	49.3	19,300	68.6	16,100	75.6	15,200	79.0	12,100	81.6	11,200		
12	38.5	15,800	64.3	15,000	72.7	14,000	77.0	12,100	79.9	10,300	81.7	7,050
15			57.5	10,900	68.4	10,500	73.5	11,100	77.4	9,300	79.8	7,050
20			44.3	6,300	60.6	6,250	68.1	6,800	72.6	7,000	75.9	6,600
25			25.6	4,000	52.2	3,900	62.2	4,500	68.3	4,700	72.3	4,800
30					42.6	2,500	56.1	3,000	63.5	3,300	68.4	3,500
35					30.5	1,550	49.1	2,050	58.5	2,350	64.3	2,500
40							41.2	1,350	53.0	1,650	59.9	1,800
45							31.5	850	46.9	1,100	55.3	1,300
50									40.3	750	50.3	900
55											45.2	600
D	0°						22°			40°		

LIFTING CAPACITIES AT ZERO DEGREE BOOM ANGLE ON OUTRIGGERS MID EXTENDED 11' 5-3/4" (3.5 m) SPREAD 360° ROTATION								
A	18.0'		30.2'		42.3'		54.5'	
	B	(5.5 m)	B	(9.2 m)	B	(12.9 m)	B	(16.6 m)
0°	14.2	12,100	26.8	3,400	39.3	900	51.4	400

1 PART OF LINE

ON OUTRIGGERS MID EXTENDED 11' 5-3/4" (3.5 m) SPREAD 360° ROTATION												
A	18.0'		30.2'		42.3'		54.5'		66.6'		78.7'	
	C	(5.5 m)	C	(9.2 m)	C	(12.9 m)	C	(16.6 m)	C	(20.3 m)	C	(24.0 m)
4	75.9	7,050	81.7	7,050								
5	72.6	7,050	79.9	7,050								
6	69.1	7,050	78.0	7,050	81.5	7,050						
8	61.6	7,050	74.1	7,050	78.8	7,050	81.4	7,050				
10	53.5	7,050	70.1	7,050	76.3	7,050	79.4	7,050	81.6	7,050		
12	43.7	7,050	66.0	7,050	73.5	7,050	77.4	7,050	80.0	7,050	81.9	5,700
15			59.4	7,050	69.2	7,050	74.2	7,050	77.6	7,050	79.9	5,700
20			47.0	6,300	61.9	6,250	68.9	6,800	73.5	7,000	76.5	5,700
25			30.3	4,000	53.6	3,900	63.1	4,500	68.9	4,700	72.8	4,800
30					44.5	2,500	57.1	3,000	64.2	3,300	68.9	3,500
35					33.2	1,550	50.4	2,050	59.3	2,350	64.8	2,500
40							42.8	1,350	53.8	1,650	60.6	1,800
45							33.6	850	48.0	1,100	56.0	1,300
50									41.6	750	51.2	900
55											46.1	600
D	0°						25°			41°		

LIFTING CAPACITIES AT ZERO DEGREE BOOM ANGLE ON OUTRIGGERS MID EXTENDED 11' 5-3/4" (3.5 m) SPREAD 360° ROTATION								
A	18.0'		30.2'		42.3'		54.5'	
	B	(5.5 m)	B	(9.2 m)	B	(12.9 m)	B	(16.6 m)
0°	15.1	7,000	27.8	3,100	40.2	800	52.3	300

- A: Boom length in feet
- B: Load radius in feet
- C: Loaded boom angle (°)
- D: Minimum boom angle (°) for indicated boom length (no load)

GR-150XL RATED LIFTING CAPACITIES (IN POUNDS)

4 PARTS OF LINE

ON OUTRIGGERS MID EXTENDED 8' 2-3/8" (2.5 m) SPREAD 360° ROTATION												
B	18.0'		30.2'		42.3'		54.5'		66.6'		78.7'	
	C	(5.5 m)	C	(9.2 m)	C	(12.9 m)	C	(16.6 m)	C	(20.3 m)	C	(24.0 m)
4	72.2	30,000	80.4	16,100								
5	68.8	30,000	78.5	16,100	82.0	16,100						
6	65.5	27,600	76.6	16,100	80.9	16,100						
8	58.2	20,500	72.5	16,100	78.3	15,700	81.1	12,100				
10	49.3	13,500	68.7	13,200	75.5	13,200	79.0	11,900	81.6	11,200		
12	38.5	9,500	64.2	9,400	72.6	9,500	76.8	9,900	79.5	10,000	81.7	7,050
15			57.5	6,000	68.1	6,000	73.4	6,400	77.0	6,700	79.7	6,900
20			44.2	3,300	60.5	3,300	67.8	3,600	72.6	4,000	75.8	4,200
25			25.6	2,000	52.1	2,000	62.0	2,400	67.9	2,600	71.9	2,800
30					42.6	1,000	55.9	1,400	63.2	1,700	68.0	1,800
35							49.0	800	58.2	1,100	63.9	1,200
40											59.5	700
D												

LIFTING CAPACITIES AT ZERO DEGREE BOOM ANGLE ON OUTRIGGERS MID EXTENDED 8' 2-3/8" (2.5 m) SPREAD 360° ROTATION				
C	18.0'		30.2'	
	B	(5.5 m)	B	(9.2 m)
0°	14.2	6,900	26.8	1,600

1 PART OF LINE

ON OUTRIGGERS MID EXTENDED 8' 2-3/8" (2.5 m) SPREAD 360° ROTATION												
B	18.0'		30.2'		42.3'		54.5'		66.6'		78.7'	
	C	(5.5 m)	C	(9.2 m)	C	(12.9 m)	C	(16.6 m)	C	(20.3 m)	C	(24.0 m)
4	75.9	7,050	81.7	7,050								
5	72.6	7,050	79.9	7,050								
6	69.1	7,050	78.0	7,050	81.5	7,050						
8	61.6	7,050	74.1	7,050	78.8	7,050	81.4	7,050				
10	53.5	7,050	70.1	7,050	76.3	7,050	79.4	7,050	81.6	7,050		
12	43.7	7,050	66.0	7,050	73.5	7,050	77.4	7,050	80.0	7,050	81.9	5,700
15			59.4	6,000	69.2	6,000	74.2	6,400	77.6	6,700	79.9	5,700
20			46.9	3,300	61.8	3,300	68.7	3,600	73.1	4,000	76.2	4,200
25			30.3	2,000	53.6	2,000	62.9	2,400	68.5	2,600	72.4	2,800
30					44.4	1,000	56.9	1,400	63.9	1,700	68.5	1,800
35							50.3	800	59.1	1,100	64.5	1,200
40											60.1	700
D												

LIFTING CAPACITIES AT ZERO DEGREE BOOM ANGLE ON OUTRIGGERS MID EXTENDED 8' 2-3/8" (2.5 m) SPREAD 360° ROTATION				
C	18.0'		30.2'	
	B	(5.5 m)	B	(9.2 m)
0°	15.1	5,900	27.8	1,400

- A: Boom length in feet
- B: Load radius in feet
- C: Loaded boom angle (°)
- D: Minimum boom angle (°) for indicated boom length (no load)

GR-150XL RATED LIFTING CAPACITIES (IN POUNDS)

4 PARTS OF LINE

ON OUTRIGGERS MIN EXTENDED 5' 4-1/2" (1.64 m) SPREAD 360° ROTATION												
A \ B	18.0'		30.2'		42.3'		54.5'		66.6'		78.7'	
	C	(5.5 m)	C	(9.2 m)	C	(12.9 m)	C	(16.6 m)	C	(20.3 m)	C	(24.0 m)
4	72.9	17,500	80.5	13,200								
5	69.6	17,000	78.6	13,000	82.1	12,500						
6	66.0	13,800	76.6	12,300	80.8	12,500						
8	58.3	8,800	72.6	8,800	78.1	8,300	80.9	7,700				
10	49.4	5,900	68.6	6,100	75.3	5,600	78.8	5,700	81.1	5,800		
12	38.5	4,500	64.2	4,100	72.4	4,050	76.6	4,300	79.3	4,500	81.4	4,500
15			57.5	2,600	68.0	2,600	73.3	2,800	76.7	3,100	79.1	3,300
20			44.2	1,000	60.4	1,050	67.7	1,400	72.2	1,700	75.3	2,000
25											71.5	1,000
D	0°		45°		52°		62°		68°		68°	

LIFTING CAPACITIES AT ZERO DEGREE BOOM ANGLE ON OUTRIGGERS MID EXTENDED 5' 4-1/2" (1.64 m) SPREAD 360° ROTATION		
A \ C	18.0'	
	B	(5.5 m)
0°	14.2	3,000

1 PART OF LINE

ON OUTRIGGERS MIN EXTENDED 5' 4-1/2" (1.64 m) SPREAD 360° ROTATION												
A \ B	18.0'		30.2'		42.3'		54.5'		66.6'		78.7'	
	C	(5.5 m)	C	(9.2 m)	C	(12.9 m)	C	(16.6 m)	C	(20.3 m)	C	(24.0 m)
4	75.9	7,050	81.7	7,050								
5	72.6	7,050	79.9	7,050								
6	69.1	7,050	78.0	7,050	81.5	7,050						
8	61.6	7,050	74.1	7,050	78.8	7,050	81.4	7,050				
10	53.5	5,900	70.1	6,100	76.2	5,600	79.3	5,700	81.6	5,800		
12	43.7	4,500	66.0	4,100	73.3	4,050	77.2	4,300	79.8	4,500	81.7	4,500
15			59.4	2,600	69.1	2,600	74.0	2,800	77.2	3,100	79.5	3,300
20			46.9	1,000	61.6	1,050	68.5	1,400	72.8	1,700	75.8	2,000
25											72.0	1,000
D	0°		47°		54°		63°		69°		69°	

LIFTING CAPACITIES AT ZERO DEGREE BOOM ANGLE ON OUTRIGGERS MID EXTENDED 5' 4-1/2" (1.64 m) SPREAD 360° ROTATION		
A \ C	18.0'	
	B	(5.5 m)
0°	15.1	2,500

- A: Boom length in feet
- B: Load radius in feet
- C: Loaded boom angle (°)
- D: Minimum boom angle (°) for indicated boom length (no load)

GR-150XL RATED LIFTING CAPACITIES (IN POUNDS)

ON OUTRIGGERS FULLY EXTENDED 15' 5" (4.7 m) SPREAD 360° ROTATION																	
C	78.7' (24.0 m) Boom + 11.8' (3.6 m) Jib								C	78.7' (24.0 m) Boom + 18' (5.5 m) Jib							
	5° Tilt		25° Tilt		45° Tilt		60° Tilt			5° Tilt		25° Tilt		45° Tilt		60° Tilt	
	R	W	R	W	R	W	R	W		R	W	R	W	R	W	R	W
82°	14.1	3,500	18.3	3,000	21.4	2,200	22.7	1,500	82°	15.3	2,200	22.0	2,100	26.5	1,400	28.5	950
80°	17.5	3,500	21.6	2,900	24.5	2,200	25.7	1,500	80°	18.9	2,200	25.7	2,100	30.0	1,400	31.8	950
77.5°	21.8	3,500	25.8	2,750	28.6	2,200	29.4	1,500	77.5°	23.6	2,200	29.9	1,900	34.1	1,350	35.6	950
75°	26.0	3,500	29.8	2,650	32.4	2,100	33.1	1,500	75°	28.3	2,200	34.3	1,800	37.9	1,300	39.0	950
72.5°	30.0	3,100	33.7	2,450	36.1	2,000	36.5	1,500	72.5°	32.6	2,200	38.0	1,650	41.5	1,250	42.7	900
70°	33.8	2,800	37.2	2,250	39.5	1,950	39.9	1,500	70°	36.8	2,100	41.8	1,550	45.0	1,200	45.9	900
67.5°	37.6	2,600	40.8	2,150	42.9	1,850	43.1	1,500	67.5°	40.6	1,950	45.5	1,450	48.6	1,150	49.2	900
65°	41.1	2,350	44.3	2,000	46.1	1,750	46.3	1,500	65°	44.5	1,800	49.2	1,400	51.9	1,150	52.5	900
62.5°	44.6	2,150	47.7	1,900	49.3	1,700	49.3	1,500	62.5°	48.1	1,650	52.6	1,300	55.2	1,100	55.6	900
60°	47.9	2,000	50.9	1,800	52.4	1,650	52.3	1,500	60°	51.8	1,550	56.0	1,250	58.3	1,050	58.5	900
57.5°	51.1	1,850	53.9	1,650	55.3	1,550			57.5°	55.2	1,450	59.3	1,200	61.3	1,000		
55°	54.2	1,650	56.8	1,550	58.0	1,500			55°	58.5	1,350	62.4	1,150	64.1	1,000		
52.5°	57.2	1,500	59.6	1,400	60.8	1,400			52.5°	61.7	1,250	65.5	1,100	66.9	1,000		
50°	60.1	1,300	62.4	1,250	63.4	1,250			50°	64.7	1,150	68.3	1,050	69.4	950		
47.5°	62.8	1,200	65.0	1,150	65.6	1,100			47.5°	67.7	1,050	70.9	950	71.8	900		
45°	65.5	1,050	67.5	1,000	67.9	1,000			45°	70.4	950	73.5	850	74.2	850		
42.5°	68.0	950	69.8	900					42.5°	73.2	900	75.9	800				
40°	70.4	850	72.0	850					40°	75.8	800	78.1	700				
37.5°	72.5	750	74.1	750					37.5°	78.1	700	80.2	650				
35°	74.7	700	76.0	650					35°	80.3	650	82.2	600				
32.5°	76.6	650	77.8	600					32.5°	82.3	600	83.9	550				
30°	78.4	600	79.4	550					30°	84.2	550	85.5	500				
27.5°	80.1	550	80.8	500													
25°	81.5	500	82.1	450													

ON OUTRIGGERS MID EXTENDED 14' 1-1/4" (4.3 m) SPREAD 360° ROTATION																	
C	78.7' (24.0 m) Boom + 11.8' (3.6 m) Jib								C	78.7' (24.0 m) Boom + 18' (5.5 m) Jib							
	5° Tilt		25° Tilt		45° Tilt		60° Tilt			5° Tilt		25° Tilt		45° Tilt		60° Tilt	
	R	W	R	W	R	W	R	W		R	W	R	W	R	W	R	W
82°	14.1	3,500	18.3	3,000	21.4	2,200	22.7	1,500	82°	15.3	2,200	22.0	2,100	26.5	1,400	28.5	950
80°	17.5	3,500	21.6	2,900	24.5	2,200	25.7	1,500	80°	18.9	2,200	25.7	2,100	30.0	1,400	31.8	950
77.5°	21.8	3,500	25.8	2,750	28.6	2,200	29.4	1,500	77.5°	23.6	2,200	29.9	1,900	34.1	1,350	35.6	950
75°	26.0	3,500	29.8	2,650	32.4	2,100	33.1	1,500	75°	28.3	2,200	34.3	1,800	37.9	1,300	39.0	950
72.5°	30.0	3,100	33.7	2,450	36.1	2,000	36.5	1,500	72.5°	32.6	2,200	38.0	1,650	41.5	1,250	42.7	900
70°	33.8	2,800	37.2	2,250	39.5	1,950	39.9	1,500	70°	36.8	2,100	41.8	1,550	45.0	1,200	45.9	900
67.5°	37.6	2,600	40.8	2,150	42.9	1,850	43.1	1,500	67.5°	40.6	1,950	45.5	1,450	48.6	1,150	49.2	900
65°	41.1	2,350	44.3	2,000	46.1	1,750	46.3	1,500	65°	44.5	1,800	49.2	1,400	51.9	1,150	52.5	900
62.5°	44.6	2,150	47.7	1,900	49.3	1,700	49.3	1,500	62.5°	48.1	1,650	52.6	1,300	55.2	1,100	55.6	900
60°	47.9	2,000	50.9	1,800	52.4	1,650	52.3	1,500	60°	51.8	1,550	56.0	1,250	58.3	1,050	58.5	900
57.5°	51.1	1,750	53.9	1,600	55.3	1,550			57.5°	55.2	1,450	59.3	1,200	61.3	1,000		
55°	54.0	1,500	56.8	1,400	58.0	1,400			55°	58.5	1,300	62.4	1,150	64.1	1,000		
52.5°	57.0	1,250	59.5	1,200	60.7	1,200			52.5°	61.6	1,100	65.3	1,000	66.9	950		
50°	59.9	1,050	62.3	1,050	63.2	1,050			50°	64.6	950	68.1	850	69.4	850		
47.5°	62.5	900	64.9	900	65.5	900			47.5°	67.4	800	70.8	750	71.8	750		
45°	65.2	800	67.3	750	67.8	750			45°	70.2	700	73.2	650	74.0	650		
42.5°	67.7	700	69.6	650					42.5°	72.9	600						
40°	70.1	600	71.8	550					40°	75.4	500						

C: Loaded boom angle (°)
 R: Load radius in feet
 W: Rated lifting capacity in pounds

GR-150XL RATED LIFTING CAPACITIES (IN POUNDS)

ON OUTRIGGERS MID EXTENDED 11' 5-3/4" (3.5 m) SPREAD 360° ROTATION																	
C	78.7' (24.0 m) Boom + 11.8' (3.6 m) Jib								C	78.7' (24.0 m) Boom + 18' (5.5 m) Jib							
	5° Tilt		25° Tilt		45° Tilt		60° Tilt			5° Tilt		25° Tilt		45° Tilt		60° Tilt	
	R	W	R	W	R	W	R	W		R	W	R	W	R	W	R	W
82°	14.1	3,500	18.3	3,000	21.4	2,200	22.7	1,500	82°	15.3	2,200	22.0	2,100	26.5	1,400	28.5	950
80°	17.5	3,500	21.6	2,900	24.5	2,200	25.7	1,500	80°	18.9	2,200	25.7	2,100	30.0	1,400	31.8	950
77.5°	21.8	3,500	25.8	2,750	28.6	2,200	29.4	1,500	77.5°	23.6	2,200	29.9	1,900	34.1	1,350	35.6	950
75°	26.0	3,500	29.8	2,650	32.4	2,100	33.1	1,500	75°	28.3	2,200	34.3	1,800	37.9	1,300	39.0	950
72.5°	30.0	3,100	33.7	2,450	36.1	2,000	36.5	1,500	72.5°	32.6	2,200	38.0	1,650	41.5	1,250	42.7	900
70°	33.8	2,800	37.2	2,250	39.5	1,950	39.9	1,500	70°	36.8	2,100	41.8	1,550	45.0	1,200	45.9	900
67.5°	37.4	2,350	40.8	2,000	42.9	1,800	43.1	1,500	67.5°	40.6	1,950	45.5	1,450	48.6	1,150	49.2	900
65°	40.8	1,950	44.1	1,750	46.1	1,650	46.3	1,500	65°	44.3	1,700	49.2	1,400	51.9	1,100	52.5	900
62.5°	44.2	1,600	47.2	1,450	49.1	1,400	49.3	1,300	62.5°	47.9	1,450	52.5	1,200	55.0	1,000	55.6	900
60°	47.2	1,300	50.4	1,200	52.1	1,150	52.2	1,150	60°	51.3	1,150	55.8	1,000	58.2	950	58.5	900
57.5°	50.6	1,050	53.4	1,000	54.8	950			57.5°	54.7	950	58.8	800	61.1	800		
55°	53.7	850	56.3	800	57.6	800			55°	58.0	750	61.9	650	63.8	650		
52.5°	56.5	650	59.2	600	60.3	600			52.5°	61.0	600						
50°	59.4	500	61.9	500	62.8	500			50°	64.0	500						

ON OUTRIGGERS MID EXTENDED 8' 2-3/8" (2.5 m) SPREAD 360° ROTATION																	
C	78.7' (24.0 m) Boom + 11.8' (3.6 m) Jib								C	78.7' (24.0 m) Boom + 18' (5.5 m) Jib							
	5° Tilt		25° Tilt		45° Tilt		60° Tilt			5° Tilt		25° Tilt		45° Tilt		60° Tilt	
	R	W	R	W	R	W	R	W		R	W	R	W	R	W	R	W
82°	14.1	3,500	18.3	3,000	21.4	2,200	22.7	1,500	82°	15.3	2,200	22.0	2,100	26.5	1,400	28.5	950
80°	17.5	3,500	21.6	2,900	24.5	2,200	25.7	1,500	80°	18.9	2,200	25.7	2,100	30.0	1,400	31.8	950
77.5°	21.6	2,950	25.6	2,500	28.6	2,000	29.4	1,500	77.5°	23.6	2,100	29.9	1,850	34.1	1,350	35.6	950
75°	25.5	2,450	29.4	2,050	32.4	1,800	33.1	1,500	75°	28.0	2,000	33.9	1,550	37.9	1,300	39.0	950
72.5°	29.3	1,900	33.2	1,600	35.7	1,450	36.3	1,250	72.5°	32.0	1,600	37.6	1,250	41.4	1,100	42.7	900
70°	32.9	1,350	36.5	1,200	38.9	1,100	39.5	1,000	70°	35.8	1,150	41.2	950	44.8	850	45.9	850
67.5°	36.5	1,000	40.0	900	42.2	850	42.7	800	67.5°	39.6	850	44.8	700	48.1	650	49.1	650
65°	40.1	700	43.3	650	45.3	600	45.7	600	65°	43.2	550	48.1	500	51.3	500	52.2	500

C: Loaded boom angle (°)
R: Load radius in feet
W: Rated lifting capacity in pounds

GR-150XL RATED LIFTING CAPACITIES (IN POUNDS)

ON OUTRIGGERS FULLY EXTENDED 15' 5" (4.7 m) SPREAD 360° ROTATION																	
C	66.6' (20.3 m) Boom + 11.8' (3.6 m) Jib								C	66.6' (20.3 m) Boom + 18' (5.5 m) Jib							
	5° Tilt		25° Tilt		45° Tilt		60° Tilt			5° Tilt		25° Tilt		45° Tilt		60° Tilt	
	R	W	R	W	R	W	R	W		R	W	R	W	R	W	R	W
82°	12.1	5,000	16.0	3,000	19.0	2,200	20.3	1,500	82°	13.5	3,000	20.0	2,200	24.6	1,400	26.7	950
80°	15.0	5,000	18.8	3,000	21.7	2,200	23.0	1,500	80°	16.6	3,000	23.1	2,200	27.5	1,400	29.3	950
77.5°	18.6	4,500	22.3	3,000	25.0	2,200	26.0	1,500	77.5°	20.5	3,000	26.9	2,200	30.9	1,400	32.6	950
75°	21.9	4,100	25.8	3,000	28.2	2,200	29.2	1,500	75°	24.5	3,000	30.5	2,200	34.3	1,350	35.7	950
72.5°	25.4	3,800	29.1	2,800	31.5	2,200	32.2	1,500	72.5°	28.1	2,800	33.9	2,000	37.4	1,300	38.6	950
70°	28.8	3,500	32.3	2,650	34.5	2,200	35.2	1,500	70°	31.9	2,550	37.1	1,800	40.3	1,250	41.6	950
67.5°	32.1	3,200	35.5	2,550	37.5	2,200	38.0	1,500	67.5°	35.3	2,400	40.3	1,700	43.3	1,200	44.3	900
65°	35.2	2,950	38.3	2,450	40.3	2,200	40.6	1,500	65°	38.7	2,200	43.4	1,600	46.2	1,200	46.9	900
62.5°	38.3	2,800	41.3	2,350	43.0	2,100	43.2	1,500	62.5°	41.9	2,100	46.4	1,500	48.9	1,150	49.6	900
60°	41.1	2,600	44.0	2,200	45.6	2,050	45.7	1,500	60°	45.0	1,950	49.2	1,450	51.6	1,100	52.0	900
57.5°	43.9	2,450	46.6	2,100	48.1	2,000			57.5°	48.1	1,850	52.1	1,400	54.2	1,100		
55°	46.6	2,300	49.1	2,000	50.4	1,900			55°	51.0	1,750	54.9	1,350	56.7	1,050		
52.5°	49.2	2,150	51.7	1,900	52.7	1,700			52.5°	53.8	1,650	57.4	1,300	59.0	1,050		
50°	51.7	1,950	54.0	1,800	54.9	1,500			50°	56.4	1,550	60.0	1,250	61.3	1,050		
47.5°	54.2	1,800	56.1	1,700	56.9	1,300			47.5°	59.0	1,450	62.3	1,200	63.3	1,050		
45°	56.2	1,600	58.2	1,550	58.9	1,150			45°	61.4	1,350	64.4	1,150	65.3	1,050		
42.5°	58.4	1,450	60.3	1,400					42.5°	63.8	1,250	66.5	1,100				
40°	60.5	1,300	62.2	1,250					40°	66.0	1,150	68.5	1,050				
37.5°	62.5	1,200	63.9	1,150					37.5°	68.0	1,050	70.3	1,000				
35°	64.4	1,100	65.6	1,050					35°	70.0	950	71.9	900				
32.5°	66.0	1,050	67.1	1,000					32.5°	71.8	900	73.5	850				
30°	67.6	950	68.5	900					30°	73.5	800	74.9	800				
27.5°	69.2	900	69.8	850					27.5°	75.1	750	76.2	750				
25°	70.4	850	70.9	800					25°	76.4	700	77.3	700				

ON OUTRIGGERS MID EXTENDED 14' 1-1/4" (4.3 m) SPREAD 360° ROTATION																	
C	66.6' (20.3 m) Boom + 11.8' (3.6 m) Jib								C	66.6' (20.3 m) Boom + 18' (5.5 m) Jib							
	5° Tilt		25° Tilt		45° Tilt		60° Tilt			5° Tilt		25° Tilt		45° Tilt		60° Tilt	
	R	W	R	W	R	W	R	W		R	W	R	W	R	W	R	W
82°	12.1	5,000	16.0	3,000	19.0	2,200	20.3	1,500	82°	13.5	3,000	20.0	2,200	24.6	1,400	26.7	950
80°	15.0	5,000	18.8	3,000	21.7	2,200	23.0	1,500	80°	16.6	3,000	23.1	2,200	27.5	1,400	29.3	950
77.5°	18.6	4,500	22.3	3,000	25.0	2,200	26.0	1,500	77.5°	20.5	3,000	26.9	2,200	30.9	1,400	32.6	950
75°	21.9	4,100	25.8	3,000	28.2	2,200	29.2	1,500	75°	24.5	3,000	30.5	2,200	34.3	1,350	35.7	950
72.5°	25.4	3,800	29.1	2,800	31.5	2,200	32.2	1,500	72.5°	28.1	2,800	33.9	2,000	37.4	1,300	38.6	950
70°	28.8	3,500	32.3	2,650	34.5	2,200	35.2	1,500	70°	31.9	2,550	37.1	1,800	40.3	1,250	41.6	950
67.5°	32.1	3,200	35.5	2,550	37.5	2,200	38.0	1,500	67.5°	35.3	2,400	40.3	1,700	43.3	1,200	44.3	900
65°	35.2	2,950	38.3	2,450	40.3	2,200	40.6	1,500	65°	38.7	2,200	43.4	1,600	46.2	1,200	46.9	900
62.5°	38.3	2,800	41.3	2,350	43.0	2,100	43.2	1,500	62.5°	41.9	2,100	46.4	1,500	48.9	1,150	49.6	900
60°	41.1	2,600	44.0	2,200	45.6	2,050	45.7	1,500	60°	45.0	1,950	49.2	1,450	51.6	1,100	52.0	900
57.5°	43.9	2,300	46.6	2,100	48.1	2,000			57.5°	48.1	1,850	52.1	1,400	54.2	1,100		
55°	46.5	2,000	49.1	1,900	50.4	1,900			55°	51.0	1,700	54.9	1,350	56.7	1,050		
52.5°	49.1	1,800	51.6	1,700	52.7	1,700			52.5°	53.8	1,550	57.4	1,300	59.0	1,050		
50°	51.6	1,550	53.9	1,500	54.9	1,500			50°	56.4	1,350	60.0	1,250	61.3	1,050		
47.5°	54.0	1,350	56.1	1,300	56.9	1,300			47.5°	59.0	1,200	62.3	1,100	63.3	1,050		
45°	56.2	1,200	58.2	1,150	58.9	1,150			45°	61.4	1,050	64.4	1,000	65.3	950		
42.5°	58.4	1,000	60.3	1,000					42.5°	63.8	950	66.5	850				
40°	60.5	900	62.2	900					40°	66.0	800	68.5	750				
37.5°	62.5	800	63.9	800					37.5°	68.0	700	70.3	650				
35°	64.4	700	65.6	700					35°	70.0	650	71.9	600				
32.5°	66.0	600	67.1	600					32.5°	71.8	550	73.5	550				
30°	67.6	550	68.5	550					30°	73.5	500	74.9	500				

C: Loaded boom angle (°)
 R: Load radius in feet
 W: Rated lifting capacity in pounds

GR-150XL RATED LIFTING CAPACITIES (IN POUNDS)

ON OUTRIGGERS MID EXTENDED 11' 5-3/4" (3.5 m) SPREAD 360° ROTATION																	
C	66.6' (20.3 m) Boom + 11.8' (3.6 m) Jib								C	66.6' (20.3 m) Boom + 18' (5.5 m) Jib							
	5° Tilt		25° Tilt		45° Tilt		60° Tilt			5° Tilt		25° Tilt		45° Tilt		60° Tilt	
	R	W	R	W	R	W	R	W		R	W	R	W	R	W	R	W
82°	12.1	5,000	16.0	3,000	19.0	2,200	20.3	1,500	82°	13.5	3,000	20.0	2,200	24.6	1,400	26.7	950
80°	15.0	5,000	18.8	3,000	21.7	2,200	23.0	1,500	80°	16.6	3,000	23.1	2,200	27.5	1,400	29.3	950
77.5°	18.6	4,500	22.3	3,000	25.0	2,200	26.0	1,500	77.5°	20.5	3,000	26.9	2,200	30.9	1,400	32.6	950
75°	21.9	4,100	25.8	3,000	28.2	2,200	29.2	1,500	75°	24.5	3,000	30.5	2,200	34.3	1,350	35.7	950
72.5°	25.4	3,800	29.1	2,800	31.5	2,200	32.2	1,500	72.5°	28.1	2,800	33.9	2,000	37.4	1,300	38.6	950
70°	28.8	3,500	32.3	2,650	34.5	2,200	35.2	1,500	70°	31.9	2,550	37.1	1,800	40.3	1,250	41.6	950
67.5°	32.1	3,100	35.5	2,500	37.5	2,200	38.0	1,500	67.5°	35.3	2,350	40.3	1,700	43.3	1,200	44.3	900
65°	35.1	2,600	38.3	2,300	40.3	2,200	40.6	1,500	65°	38.6	2,100	43.4	1,600	46.2	1,200	46.9	900
62.5°	38.0	2,200	41.1	2,000	42.8	1,900	43.2	1,500	62.5°	41.7	1,850	46.4	1,500	48.9	1,150	49.6	900
60°	40.8	1,800	43.7	1,700	45.4	1,650	45.7	1,500	60°	44.8	1,600	49.2	1,350	51.6	1,100	52.0	900
57.5°	43.5	1,550	46.4	1,450	47.9	1,400			57.5°	47.8	1,350	52.1	1,200	54.2	1,000		
55°	46.2	1,300	48.9	1,200	50.2	1,200			55°	50.7	1,150	54.6	1,000	56.6	950		
52.5°	48.8	1,100	51.4	1,000	52.4	1,000			52.5°	53.3	950	57.2	850	58.9	850		
50°	51.3	900	53.6	800	54.6	800			50°	56.1	800	59.6	700	61.1	700		
47.5°	53.7	750	55.9	650	56.7	650			47.5°	58.7	650	62.0	600	63.1	600		
45°	56.0	600	58.0	550	58.6	550			45°	61.2	550	64.2	500	65.1	500		

ON OUTRIGGERS MID EXTENDED 8' 2-3/8" (2.5 m) SPREAD 360° ROTATION																	
C	66.6' (20.3 m) Boom + 11.8' (3.6 m) Jib								C	66.6' (20.3 m) Boom + 18' (5.5 m) Jib							
	5° Tilt		25° Tilt		45° Tilt		60° Tilt			5° Tilt		25° Tilt		45° Tilt		60° Tilt	
	R	W	R	W	R	W	R	W		R	W	R	W	R	W	R	W
82°	12.1	5,000	16.0	3,000	19.0	2,200	20.3	1,500	82°	13.5	3,000	20.0	2,200	24.6	1,400	26.7	950
80°	15.0	5,000	18.8	3,000	21.7	2,200	23.0	1,500	80°	16.6	3,000	23.1	2,200	27.5	1,400	29.3	950
77.5°	18.4	4,000	22.3	2,800	25.0	2,200	26.0	1,500	77.5°	20.5	2,750	26.7	2,100	30.9	1,400	32.6	950
75°	21.8	3,200	25.6	2,550	28.2	2,200	29.2	1,500	75°	24.2	2,450	30.4	2,000	34.3	1,350	35.7	950
72.5°	25.0	2,500	28.7	2,050	31.3	1,800	32.2	1,500	72.5°	27.8	2,000	33.8	1,650	37.4	1,250	38.6	950
70°	28.2	1,800	31.9	1,550	34.3	1,400	35.2	1,500	70°	31.3	1,500	36.9	1,250	40.3	1,100	41.6	950
67.5°	31.4	1,400	35.0	1,250	37.1	1,150	38.0	1,150	67.5°	34.8	1,200	39.9	1,000	43.0	850	44.2	750
65°	34.4	1,000	37.8	900	39.8	900	40.5	900	65°	37.9	850	42.9	700	45.9	600	46.8	600
62.5°	37.4	750	40.6	700	42.5	700	43.0	700	62.5°	41.0	650						
60°	40.2	500	43.3	500	44.9	500	45.4	500	60°	44.1	500						

C: Loaded boom angle (°)
R: Load radius in feet
W: Rated lifting capacity in pounds

GR-150XL RATED LIFTING CAPACITIES (IN POUNDS)

4 PARTS OF LINE

ON RUBBER STATIONARY												
A	Over Front						360° Rotation					
	18.0'		30.2'		42.3'		18.0'		30.2'		42.3'	
B	C	(5.5 m)	C	(9.2 m)	C	(12.9 m)	C	(5.5 m)	C	(9.2 m)	C	(12.9 m)
	4	73.5	7,900	80.6	7,900			73.6	6,200	80.6	6,200	
6	66.3	7,650	76.7	7,650	80.8	7,900	66.3	6,200	76.7	6,200	80.7	6,150
8	58.5	6,900	72.7	6,900	78.0	6,900	58.5	4,900	72.7	4,800	77.9	4,700
10	49.4	5,750	68.6	5,650	75.3	5,500	49.4	3,450	68.6	3,350	75.2	3,200
12	38.5	4,850	64.2	4,600	72.4	4,350	38.5	2,500	64.2	2,350	72.3	2,100
15			57.5	3,450	68.0	3,000			57.5	1,000	68.0	750
20			44.2	1,900	60.3	1,700						
25			25.6	550	52.0	650						
D	0°			43°			0°		45°		61°	

LIFTING CAPACITIES AT ZERO DEGREE BOOM ANGLE ON RUBBER STATIONARY												
A	Over Front						360° Rotation					
	18.0'		30.2'				18.0'					
C	B	(5.5 m)	B	(9.2 m)			B	(5.5 m)				
	0°	14.2	3,800	26.8	300			14.2	1,300			

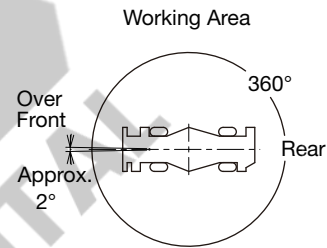

4 PARTS OF LINE

ON RUBBER CREEP							
A	Over Front						
	18.0'		30.2'		42.3'		
B	C	(5.5 m)	C	(9.2 m)	C	(12.9 m)	
	4	73.5	7,050	80.6	7,050		
6	66.3	6,750	76.7	6,750	80.7	7,050	
8	58.5	6,200	72.7	6,100	77.9	5,900	
10	49.4	5,200	68.6	4,950	75.2	4,750	
12	38.5	4,150	64.2	4,000	72.3	3,750	
15			57.5	3,000	68.0	2,700	
20			44.2	1,700	60.3	1,500	
25			25.6	500	52.0	650	
D	0°			43°			

LIFTING CAPACITIES AT ZERO DEGREE BOOM ANGLE ON RUBBER CREEP							
A	Over Front						
	18.0'		30.2'				
C	B	(5.5 m)	B	(9.2 m)			
	0°	14.2	3,200	26.8	300		

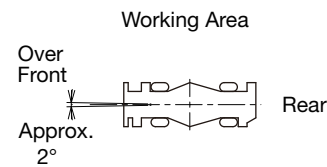

- A: Boom length in feet
- B: Load radius in feet
- C: Loaded boom angle (°)
- D: Minimum boom angle (°) for indicated boom length (no load)

GR-150XL RATED LIFTING CAPACITIES (IN POUNDS)

1 PART OF LINE

ON RUBBER STATIONARY												
A	Over Front						360° Rotation					
	18.0'		30.2'		42.3'		18.0'		30.2'		42.3'	
B	C	(5.5 m)	C	(9.2 m)	C	(12.9 m)	C	(5.5 m)	C	(9.2 m)	C	(12.9 m)
4	75.9	7,050	81.7	7,050			75.9	6,200	81.7	6,200		
6	69.1	7,050	78.0	7,050	81.5	7,050	69.1	6,200	78.0	6,200	81.5	6,150
8	61.6	6,900	74.1	6,900	78.8	6,900	61.7	4,900	74.1	4,800	78.8	4,700
10	53.5	5,750	70.1	5,650	76.1	5,500	53.5	3,450	70.1	3,350	76.1	3,200
12	43.7	4,850	66.0	4,600	73.3	4,350	43.7	2,500	65.9	2,350	73.3	2,100
15			59.4	3,450	69.1	3,000			59.4	1,000	69.1	750
20			46.9	1,900	61.6	1,700						
25			30.3	550	53.5	650						
D	0°			45°			0°		47°		62°	

LIFTING CAPACITIES AT ZERO DEGREE BOOM ANGLE ON RUBBER STATIONARY												
A	Over Front						360° Rotation					
	18.0'		30.2'				18.0'					
C	B	(5.5 m)	B	(9.2 m)			B	(5.5 m)				
0°	15.1	3,400	27.8	200			15.1	900				

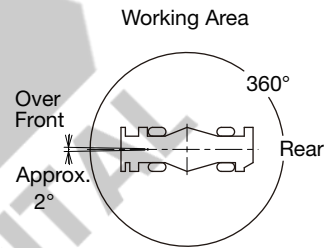

1 PART OF LINE

ON RUBBER CREEP							
A	Over Front						
	18.0'		30.2'		42.3'		
B	C	(5.5 m)	C	(9.2 m)	C	(12.9 m)	
4	75.9	7,050	81.6	7,050			
6	69.1	6,750	78.0	6,750	81.5	7,050	
8	61.6	6,200	74.1	6,100	78.8	5,900	
10	53.5	5,200	70.1	4,950	76.1	4,750	
12	43.7	4,150	66.0	4,000	73.3	3,750	
15			59.4	3,000	69.1	2,700	
20			46.9	1,700	61.6	1,500	
25			30.3	500	53.5	650	
D	0°			45°			

LIFTING CAPACITIES AT ZERO DEGREE BOOM ANGLE ON RUBBER CREEP							
A	Over Front						
	18.0'		30.2'				
C	B	(5.5 m)	B	(9.2 m)			
0°	15.1	2,900	27.8	200			

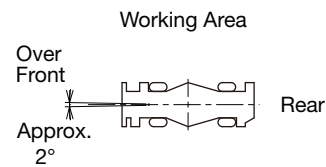

- A: Boom length in feet
- B: Load radius in feet
- C: Loaded boom angle (°)
- D: Minimum boom angle (°) for indicated boom length (no load)

WARNING AND OPERATING INSTRUCTIONS FOR ON RUBBER LIFTING CAPACITIES

1. Rated lifting capacities on rubber are in pounds and do not exceed 75% of tipping loads as determined by SAE J765-Crane Stability Test Code.
2. Rated lifting capacities shown in the chart are based on the condition that crane is set on firm level surfaces with suspension lock applied. They are based on actual load radius increased by tire deformation and boom deflection.
3. Rated lifting capacities are based on proper tire inflation, capacity and condition. Damaged tires are hazardous to safe operation of crane.
4. Tires shall be inflated to correct air pressure.

Tires	Air Pressure
315/80R22.5	123 psi (850 kPa)

5. Over front operation shall be performed within 2 degrees in front of chassis.

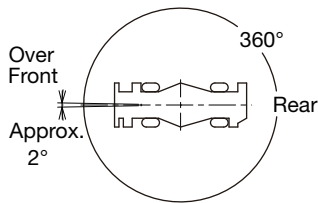

6. On rubber lifting with "jib" is not permitted. Maximum permissible boom length is 42.3' (12.9 m).

7. When making lift on rubber stationary, set parking brake.
8. For creep operation, boom must be centered over-front of machine, swing lock engaged, and load restrained from swinging. Travel slowly and keep the lifted load as close to the ground as possible, and especially avoid any abrupt steering, accelerating or braking.
9. Do not operate the crane while carrying the load.
10. Creep is motion for crane not to travel more than 200' (60 m) in any 30 minutes period and to travel at the speed of less than 1 mph (1.6 km/h).
11. For creep operation, set drive select switch to "4-WHEEL (LO)" and set gear shift switch to "1".
12. The mass of the hook (282 lbs for 15 t capacity, 109 lbs for 3.5 t capacity), slings and all similarly used load handling devices must be considered as part of the load and must be deducted from the lifting capacities.

UNIMAR
SALE & RENTAL

WARNING AND OPERATING INSTRUCTIONS FOR LIFTING CAPACITIES

GENERAL

1. RATED LIFTING CAPACITIES apply only to the machine as originally manufactured and normally equipped by TADANO LTD. Modifications to the machine or use of optional equipment other than that specified can result in a reduction of capacity.
2. Hydraulic cranes can be hazardous if improperly operated or maintained. Operation and maintenance of this machine must be in compliance with information in the **Operation and Maintenance Manual** supplied with the crane. If this manual is missing, order a replacement through the distributor.
3. The operator and other personnel associated with this machine shall fully acquaint themselves with the latest American National Standards Institute (ANSI) safety standards for cranes.

SET UP

1. Rated lifting capacities on the chart are the maximum allowable crane capacities and are based on the machine standing level on firm supporting surface under ideal job conditions. Depending on the nature of the supporting surface, it may be necessary to have structural supports under the outrigger floats or tires to spread the loads to a larger bearing surface.
2. For outrigger operation, outriggers shall be properly extended with tires free of supporting surface before operating crane.

OPERATION

1. Rated lifting capacities have been tested to and meet minimum requirements of SAE J1063-Cantilevered Boom Crane Structures Method of Test.
2. Rated lifting capacities do not exceed 85% of the tipping load on outriggers fully extended as determined by SAE J765-Crane Stability Test Code.
Rated lifting capacities for partially extended outriggers are determined from the formula, Rated Lifting Capacities=(Tipping Load - 0.1 x Tip Reaction)/1.25.
3. Rated lifting capacities are based on actual load radius increased by boom deflection.
4. The weight of handling device such as hook blocks (282 lbs for 15 t capacity, 109 lbs for 3.5 t capacity), slings, etc., must be considered as part of the load and must be deducted from the lifting capacities.
5. Rated lifting capacities are based on freely suspended loads and make no allowance for such factors as the effect of wind, sudden stopping of loads, supporting surface conditions, inflation of tires, operating speeds, side loads, etc. Side pull on the boom or jib is extremely dangerous. Such action can damage the boom, jib or slewing mechanism, and lead to overturning of the crane.
6. Rated lifting capacities do not account for wind on lifted load or boom. We recommend against working under the conditions that the load is out of control due to a strong wind. During boom lift, consider that the rated lifting capacity is reduced by 50% when the wind speed is 20 mph (9 m/s) to 27 mph (12 m/s), reduced by 70 % when the wind speed is 27 mph (12 m/s) to 31 mph (14 m/s). If the wind speed is 31 mph (14 m/s) or over, stop operation. During jib lift, stop operation if the wind speed is 20 mph (9 m/s) or over.
7. Rated lifting capacities at load radius shall not be exceeded. Do not tip the crane to determine allowable loads.
8. Do not operate at boom lengths, radii, or boom angles, where no capacities are shown. Crane may overturn without any load on the hook.
9. When boom length is between values listed, refer to the rated lifting capacities of the next longer and next shorter booms for the same radius. The lesser of the two rated lifting capacities shall be used.
10. When making lifts at a load radius not shown, use the next longer radius to determine allowable capacity.
11. Load per line should not exceed 7,500 lbs (3,400 kg).
12. Check the actual number of parts of line with Load Moment Indicator (AML-E) before operation. Maximum lifting capacity is restricted by the number of parts of line of Load Moment Indicator (AML-E). Limited capacity is as determined from the formula,
Single line pull 7,500 lbs (3,400 kg) x number of parts of line.
13. The boom angle before loading should be greater to account for deflection. For rated lifting capacities, the loaded boom angle and the load radius is for reference only.

14. The 18.0' (5.5 m) boom length capacities are based on boom fully retracted. If not fully retracted [less than 30.2' (9.2 m) boom length], use the rated lifting capacities for the 30.2' (9.2 m) boom length.
15. Extension or retraction of the boom with loads may be attempted within the limits of the RATED LIFTING CAPACITIES. The ability to telescope loads is limited by hydraulic pressure, boom angle, boom length, crane maintenance, etc.
16. When the jib is removed, turn the jib state select switch to "DISMOUNTED"
17. When erecting and stowing jib, be sure to retain it by hand or by other means to prevent its free movement.
18. Use "ANTI-TWO-BLOCK DEVICE" disable switch when erecting and stowing jib and when stowing hook block. While the switch is pushed, the hoist does not stop, even when overwind condition occurs.
19. For boom length 78.7' (24.0 m) or less and 66.6' (20.3 m) or longer with jib, rated lifting capacities are determined by loaded boom angle only in the column headed "78.7' (24.0 m) boom + jib". For boom length 66.6' (20.3 m) or less with jib, rated lifting capacities are determined by loaded boom angle only in the column headed "66.6' (20.3 m) boom + jib". For angles not shown, use the next lower loaded boom angle to determine allowable capacity.
20. The lifting capacity for over side area differs depending on outrigger extension width. Work with capacity corresponding to the extension width. The lifting capacities for over front and over rear areas are for "outriggers fully extended". However, the areas (angle a) differ depending on the outrigger extension width.

Outriggers extended width	14'-1-1/4" (4.3 m) (middle)	11'-5-3/4" (3.5 m) (middle)	8'-2-3/8" (2.5 m) (middle)	5'-4-1/2" (1.64 m) (minimum)
Angle a°	45	35	25	15

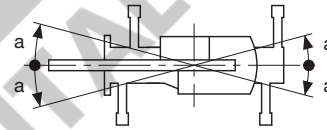

21. Be very careful not to come in contact with the mirror, engine cover, etc, with following warning messages. When operating crane in the following case.
 - When lowering the boom angles less than 12°.
 - When slewing with the boom angles less than 12°.

DEFINITIONS

1. Load Radius: Horizontal distance from a projection of the axis of rotation to supporting surface before loading to the center of the vertical hoist line or tackle with load applied.
2. Loaded Boom Angle: The angle between the boom base section and the horizontal, after lifting the rated lifting capacity at the load radius.
3. Working Area: Area measured in a circular arc about the centerline of rotation.
4. Freely Suspended Load: Load hanging free with no direct external force applied except by the hoist line.
5. Side Load: Horizontal side force applied to the lifted load either on the ground or in the air.

WARNING AND OPERATING INSTRUCTIONS FOR USING THE LOAD MOMENT INDICATOR (AML-E)

1. Set AML select keys in accordance with the actually operating crane conditions and don't fail to make sure, before crane operation, that the displays on front panel are correct.
2. When operating crane on-outriggers:
 - Before outrigger operation, turn the boom toward the front. (Locking and releasing cannot be performed in other state.)
 - Press the suspension lock switch until the suspension lock indicator lamp flashes to lights, and lower the body to the full. (Outrigger operation and crane operation cannot be performed without suspension lock.)
 - Set the PTO switch to "ON".
 - Touch the operation status registration button in the button display section.
 - Touch the outrigger setting button and the outrigger status registration screen appears on the MFD. Make sure that the display matches the actual outrigger status, and touch the set button to register. After the registration is completed, the display returns to the crane operation status.
 - Touch the lift state select button to register the lift state to be used (jib/boom). The lift status registration screen appears on the MFD. Touch a button for the boom status to be used. Touch the set button to register the setting. After the registration is completed, the display returns to the crane operation status.
 - When erecting and stowing jib, select the status of jib set, and the jib set status symbol lights up.
3. When operating crane on rubber:
 - Before on rubber operation, turn the boom toward the front. (Locking and releasing cannot be performed in other state.)
 - Press the suspension lock switch until the suspension lock indicator lamp flashes to lights, and lower the body to the full. (Crane operation cannot be performed without suspension lock.)
 - Set the PTO switch to "ON".
 - Touch the operation status registration button in the button display section.
 - Touch the outrigger setting button and the outrigger status registration screen appears on the MFD. Select the on rubber operation, and make sure that the on rubber status indicator symbol lights up. Touch the set button to register. After the registration is completed, the display returns to the crane operation status.
- Touch the lift state select button to register the lift state to be used (boom). The lift status registration screen appears on the MFD. Touch a button for the boom status to be used. Touch the set button to register the setting. After the registration is completed, the display returns to the crane operation status. However, pay attention to the following.
 - (1) For stationary operation.
 - The front capacities are attainable only when the front position symbol lights up. When the boom is more than 2 degrees from centered over-front of chassis, 360° capacities are in effect.
 - When the load is lifted in the front position and then slewed to the side area, make sure the value of the Load Moment Indicator (AML) is below the 360° lifting capacity.
 - (2) For creep operation.
 - The creep capacities are attainable only when the front position symbol lights up. If boom is not in the over-front of chassis, never lift load.
4. This machine is equipped with an automatic slewing stop device. (For the details, see Operation and Maintenance Manual.) But, operate very carefully because the automatic slewing stop does not work in the following cases.
 - During on rubber operation.
 - When the PTO switch is set to "OVERRIDE" and the "OVERRIDE" key switch outside the cab is set to "ON".
5. During crane operation, make sure that the displays on front panel are in accordance with actual operating conditions.
6. The displayed values of Load Moment Indicator (AML-E) are based on freely suspended loads and make no allowance for such factors as the effect of wind, sudden stopping of loads, supporting surface conditions, inflation of tire, operating speed, side loads, etc. For safe operation, it is recommended when extending and lowering boom or slewing, lifting loads shall be appropriately reduced.
7. Load Moment Indicator (AML-E) is intended as an aid to the operator. Under no condition should it be relied upon to replace use of capacity charts and operating instruction. Sole reliance upon Load Moment Indicator (AML-E) aids in place of good operating practice can cause an accident. The operator must exercise caution to assure safety.

GR-150XL Axle weight distribution chart

	Pounds			Kilograms		
	GVW	Front	Rear	GVW	Front	Rear
Basic machine	31,530	16,070	15,460	14,300	7,290	7,010
Remove: 2-stage jib (11-8' , 18')	-490	-590	100	-222	-268	46

UMAX
SALE & RENTAL



TADANO AMERICA Corporation

4242 West Greens Road
Houston, Texas 77066
PHONE: (281) 869-0030
FAX: (281) 869-0040
www.tadanoamerica.com

SPEC. SHEET NO TAC-GR-150-3-0-0102-03312019