

ALL-TERRAIN ATF 400G-6

Lift + Release
Adjuster



Highlights

Highlights des ATF 400G-6:

- Einhaltung der 12 t Achslasten inkl. Antrieb 12 x 8 x 12, Bereifung 445/95 R 25 (16.00 R 25), vollen Kraftstofftanks und Hakengeschirr.
- Leistungsstärkstes Antriebspaket seiner Klasse mit sparsamen Mercedes Benz BlueTec Motor, 480 kW Leistung und 3000 Nm Drehmoment sowie einem hochtechnisiertem ZF-TC-Tronic HD Getriebe in "Heavy Duty" Ausführung.
- Separater Oberwagenmotor von Mercedes Benz mit BlueTec Technologie und 195 kW Leistung und 1100 Nm Drehmoment.
- Der 60 m Hauptausleger erreicht die höchsten Traglastwerte seiner Klasse. Zum Vergrößern der Traglasten kann er zusätzlich mit einem "Power System" ausgerüstet werden.
- Vollhydraulisch abwinkelbare und teleskopierbare Auslegerverlängerung (HTLJ) für effizientes Arbeiten und Montage auf engstem Raum (Funktion wie zusätzlicher Teleskopausleger).
- Der Standardlieferumfang umfasst das volle Gegengewicht von 138 t und 4 Abstützbasen.
- Fahrzeugbreite innerhalb von 3 m bei einem Gegengewicht bis zu 25 t.
- Das Sicherheitsprogramm 'Lift- und Release Adjuster' unterbindet das gefährliche Pendeln der Last, bzw. des Hakens und sorgt somit für höchste Sicherheit und äußerst kontrollierbare Hubbewegungen bei jedem Einsatz.
- Effiziente Serviceplanung sowie Durchführung von Fehlerferndiagnosen/-behebungen mit Unterstützung der Online-Kommunikation zwischen Kranhersteller, Kranbetreiber und Kran (Hello-Net).

Highlights of the ATF 400G-6:

- 12 t axle load including drive 12 x 8 x 12, tyres 445/95 R 25 (16.00 R 25), full diesel tanks and 1 sheave hook block.
- The most powerful drive system in his class with the latest state of the art fuel saving Mercedes Benz BlueTec engine, 480 kW engine power and 3000 Nm torque as well as a high technology ZF-TC-Tronic HD transmission in "heavy duty" version.
- Separate superstructure engine Mercedes Benz BlueTec engine, 195 kW engine power and 1100 Nm torque.
- The 60 m main boom achieves the highest capacity in his class. The main boom can be additionally equipped with the "Power System" to increase the lifting capacity.
- The Hydraulic Telescopic Luffing Jib (HTLJ) is made to be fitted and operate in narrow areas (like an additional telescopic boom on top of the main telescopic boom).
- The 138 t counterweight and 4 outrigger bases are standard.
- With up to 25 t counterweight the vehicle width is not exceeded.
- The safety features 'Lift- and Release Adjuster' avoiding of dangerous swing of the load and the hook block and providing highest safety and controllable lifting motions on each job.
- Efficient Service planning as well as malfunction diagnostic, adjustment and corrections can be made via online-communication (Hello-Net) between the manufacturer, the client and the crane.

Points forts de l' ATF 400G-6:

- 12 t par essieu avec entraînement 12 x 8 x 12, pneus 445/95 R 25 (16.00 R 25), réservoir plein avec élingues.
- La chaîne d'entraînement la plus performante de sa catégorie avec le dernier développement et un moteur Mercedes Benz Blue Tec sophistiqué qui économise le plus la consommation de gazole, puissance 480 kW et 3000 Nm couple ainsi qu'une transmission haute technologie ZF-TC-Tronic HD transmission en version « poids lourds ».
- Moteur Mercedes Benz BlueTec pour la superstructure, puissance 195 kW et 1100 Nm couple.
- La flèche principale de 60 m atteint la plus grande capacité dans sa classe. La flèche principale peut être équipée en supplément avec le « Power System » pour augmenter la capacité de levage.
- Le système de la fléchette avec inclinaison et télescopage hydraulique (HTLJ) est conçu pour les opérations dans des espaces limités, (comme une flèche additionnelle au bout de la flèche télescopique).
- Le contrepoids de 138 t et le dispositif de calage en 4 points est standard.
- Jusqu'à 25 t de contrepoids la largeur du véhicule n'est pas dépassé.
- Les dispositifs de sécurité 'Lift- et Release Adjuster' évitent le balancement dangereux de la charge et du moufle et garantissent une sécurité supérieure et mouvement de levage qui sont contrôlables sur chaque levage.
- Planning du service efficient ainsi qu'un diagnostic de dysfonctionnement, ajustement et corrections peuvent être opérés par communication en ligne (Hello-Net) entre le fabricant, le client et la grue.

Highlights del ATF 400G-6:

- Peso por eje de 12 t incluido, tracción 12 x 8 x 12, neumáticos 445/95 R 25 (16,00 R 25), depósito de combustible lleno y gancho de una polea.
- Paquete de potencia con motor Mercedes Benz BlueTec 480 kW y 3000 Nm de par motor. Caja de cambios de alta tecnología modelo ZF-TC en versión "heavy duty".
- Motor independiente de grúa Mercedes Benz Blue Tec de 195 kW y 1100 Nm de par motor.
- Longitud de pluma de 60 m. Con las mejores tablas de carga en su categoría. Mejora de tablas de carga con el montaje adicional del "Power System".
- Plumin adicional con funciones hidráulicas de telescopaje y angulación (HTLJ). Optimización de espacios en zonas reducidas (funciona como pluma adicional tipo JIB).
- Maquina base con 138 t. De contrapeso. Estabilizadores hidráulicos de 4 puntos.
- Ancho de maquina de 3 m incluido contrapeso de hasta 25 to.
- Programa de seguridad 'Lift- and Release Adjuster', controla los posibles movimientos oscilantes del gancho, asegurado en cada movimiento el máximo control de la carga.
- Planificación eficiente de servicio técnico mediante un servicio de diagnosis de averías Online de comunicación creando una red entre Fabricante – Usuario – Grúa (Hello-Net).

Hubhöhen + Anbauteile
 Lifting heights + Attachment
 Hauteurs de levage + Attachement
 Alturas de elevación + Elemento de construcción





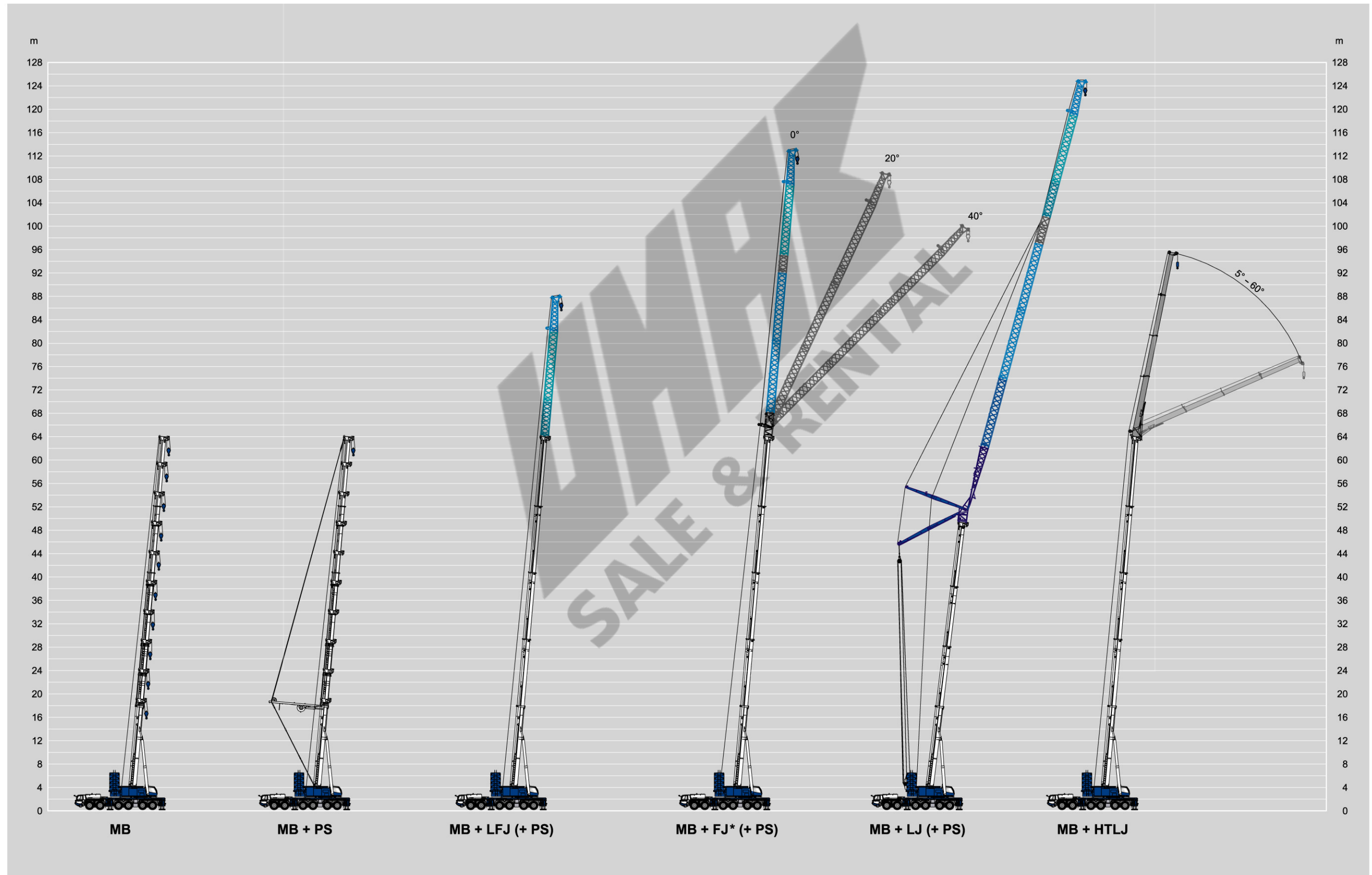





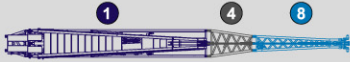



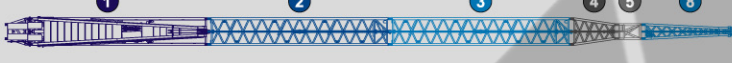

DIN/ISO/EN



Seite / Page Page / Pagina	Gegengewicht / Counterweight Contrepoids / Contrapeso	Systemübersicht / General survey of the system Vue d'ensemble du système / Sistema de vigilancia	
3-9		Auslegerverlängerungen / Boom extensions / Fléchette / Plumin	1
10-11		Gegengewichtvarianten / Counterweight versions / Variations des contrepoids / Variaciones de contrapeso	
12-13		Maße + Gewichte / Geschwindigkeiten / Dimensions + Weights / Working speeds / Dimensiones + Poids / Vitesses / Dimensiones + Pesos / Velocidades de trabajo	
14-19	138 t / 118 t / 98 t / 78 t / 58 t	MB Teleskopausleger / Telescopic boom / Flèche télescopique / Pluma telescópica	2
20-21	47 t / 25 t / 16.5 t / 7.5 t		
22	0 t		
24-25	138 t	MB + PS Teleskopausleger / Telescopic boom / Flèche télescopique / Pluma telescópica + Power-System	3
26	118 t		
27	98 t		
28-30	138 t / 118 t	MB + LFJ Teleskopausleger / Telescopic boom / Flèche télescopique / Pluma telescópica + Light fixed jib	4
31	78 t		
32	58 t		
34-36	138 t / 118 t	MB + LFJ + PS Teleskopausleger / Telescopic boom / Flèche télescopique / Pluma telescópica + Light fixed jib + Power-System	5
37	78 t		
38	58 t		
40-42	138 t / 118 t / 58 t	MB + FJ Teleskopausleger / Telescopic boom / Flèche télescopique / Pluma telescópica + Fixed jib	6
44-52	138 t / 118 t		
53-56	58 t		
58-60	138 t / 118 t / 58 t	MB + FJ + PS Teleskopausleger / Telescopic boom / Flèche télescopique / Pluma telescópica + Fixed jib + Power-System	7
62-70	138 t / 118 t		
71-74	58 t		
76-90	138 t	MB + LJ Teleskopausleger / Telescopic boom / Flèche télescopique / Pluma telescópica + Luffing jib	8
91-104	78 t		
106-113	138 t		
		MB + LJ + PS Teleskopausleger / Telescopic boom / Flèche télescopique / Pluma telescópica + Luffing jib + Power-System	9
114-117	118 t	MB + HTLJ Teleskopausleger / Telescopic boom / Flèche télescopique / Pluma telescópica + Hydraulic telescopic luffing jib	10
117-119	58 t		
120		Anmerkungen zu den Traglasttabellen / Remarks relating to the rating charts / Remarques relatives aux tableaux des charges / Notas relativas a los graficos de carga	11
121-124		Ausrüstung / Equipment / Equipement / Equipo	
125		Symbolerklärung / Symbols / Glossaire des symboles / Glosario de simbolos	

LJ Übersicht
 LJ General survey
 LJ Vue d'ensemble
 LJ Sistema de vigilancia

	DIN/ISO/EN
2.5 m + 20.3 m	
2.5 m + 32.3 m	
2.5 m + 34.0 m	
2.5 m + 40.0 m	
2.5 m + 46.0 m	
2.5 m + 52.0 m	
2.5 m + 58.0 m	
2.5 m + 64.0 m	
2.5 m + 70.0 m	
2.5 m + 76.0 m	

 Light	DIN/ISO/EN
2.5 m + 46.0 m	
2.5 m + 52.0 m	
2.5 m + 58.0 m	
2.5 m + 64.0 m	

FJ Übersicht + Teile
 FJ General survey + parts
 FJ Vue d'ensemble + parts
 FJ Sistema de vigilancia + parte

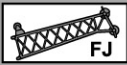

DIN / ISO / EN

Heavy Duty 5.5 m (2.0 m + 3.5 m)	
13.5 m (2.0 m + 11.5 m)	
19.5 m (2.0 m + 17.5 m)	
25.5 m (2.0 m + 23.5 m)	
31.5 m (2.0 m + 29.5 m)	
37.5 m (2.0 m + 35.5 m)	
43.5 m (2.0 m + 41.5 m)	
49.5 m (2.0 m + 47.5 m)	

Abmessungen + Gewichte / Dimensions + Weights / Dimensiones + Poids / Dimensiones + Pesos

<p>1</p> <p>Wipbasisereinheit / Luffing base jib assembly / Unité de base pour la volée variable / Tijera de abatible 12 m</p> <p>Länge / Length / Longueur / Largo: 13.575 m Breite / Width / Large / Ancho: 2.044 m Höhe / Height / Hauteur / Altura: 3.071 m Gewicht / Weight / Poid / Peso: 9105 kg</p>	<p>2</p> <p>Zwischenstück / Intermediate section / Section intermédiaire / Tramo intermedio 12 m</p> <p>Länge / Length / Longueur / Largo: 12.162 m Breite / Width / Large / Ancho: 1.836 m Höhe / Height / Hauteur / Altura: 1.520 m Gewicht / Weight / Poid / Peso: 2370 kg</p>	<p>3</p> <p>Zwischenstück / Intermediate section / Section intermédiaire / Tramo intermedio 12 m</p> <p>Länge / Length / Longueur / Largo: 12.162 m Breite / Width / Large / Ancho: 1.836 m Höhe / Height / Hauteur / Altura: 1.520 m Gewicht / Weight / Poid / Peso: 2047 kg</p>	<p>4</p> <p>Reduzierstück / Reducer / Adaptateur / Adaptador conico de "LJ a FJ" 3 m</p> <p>Länge / Length / Longueur / Largo: 3.162 m Breite / Width / Large / Ancho: 1.836 m Höhe / Height / Hauteur / Altura: 1.506 m Gewicht / Weight / Poid / Peso: 710 kg</p>	<p>5</p> <p>Abspannstück / Pendant connector section / Chevalet de haubanage / Arranque inicio plumin ligero 1,74 m</p> <p>Länge / Length / Longueur / Largo: 1.909 m Breite / Width / Large / Ancho: 1.056 m Höhe / Height / Hauteur / Altura: 1.518 m Gewicht / Weight / Poid / Peso: 600 kg</p>
<p>6</p> <p>Zwischenstück / Intermediate section / Section intermédiaire / Tramo intermedio 6 m</p> <p>Länge / Length / Longueur / Largo: 6.162 m Breite / Width / Large / Ancho: 1.081 m Höhe / Height / Hauteur / Altura: 1.475 m Gewicht / Weight / Poid / Peso: 900 kg</p>	<p>7</p> <p>Zwischenstück / Intermediate section / Section intermédiaire / Tramo intermedio 12 m</p> <p>Länge / Length / Longueur / Largo: 12.162 m Breite / Width / Large / Ancho: 1.081 m Höhe / Height / Hauteur / Altura: 1.475 m Gewicht / Weight / Poid / Peso: 1550 kg</p>	<p>8</p> <p>Auslegerspitze / Jib top section / Fléchette / Punta de plumin 6 m</p> <p>Länge / Length / Longueur / Largo: 6.515 m Breite / Width / Large / Ancho: 1.128 m Höhe / Height / Hauteur / Altura: 2.021 m Gewicht / Weight / Poid / Peso: 1386 kg</p>	<p>9</p> <p>Abwinkelstück / Adapter fixed jib / Adaptateur de flèche / Adaptador de pluma 4.15 m</p> <p>Länge / Length / Longueur / Largo: 4.312 m Breite / Width / Large / Ancho: 2.045 m Höhe / Height / Hauteur / Altura: 2.798 m Gewicht / Weight / Poid / Peso: 2164 kg</p>	<p>10</p> <p>Schwerlastkopf / Heavy duty top section / Tête d'élément pour levage lourd / Cabezal 1 m</p> <p>Länge / Length / Longueur / Largo: 1.473 m Breite / Width / Large / Ancho: 1.747 m Höhe / Height / Hauteur / Altura: 2.595 m Gewicht / Weight / Poid / Peso: 579 kg</p>

LJ Transport-Beispiel + Maße (mm)
 LJ Transport example + dimensions (mm)
 LJ Exemple de transport + dimensions (mm)
 LJ Ejemplo de transportes + dimensiones (mm)

- 1 Wippbasiseinheit
Luffing base jib assembly
Unité de base pour la
volée variable
Tijera de abatible
- 11 Montagewagen
Assembly dolly
Dolly de montage
Carro auxiliar de
montaje



Gewicht / Weight /
Poid / Peso: 400 kg

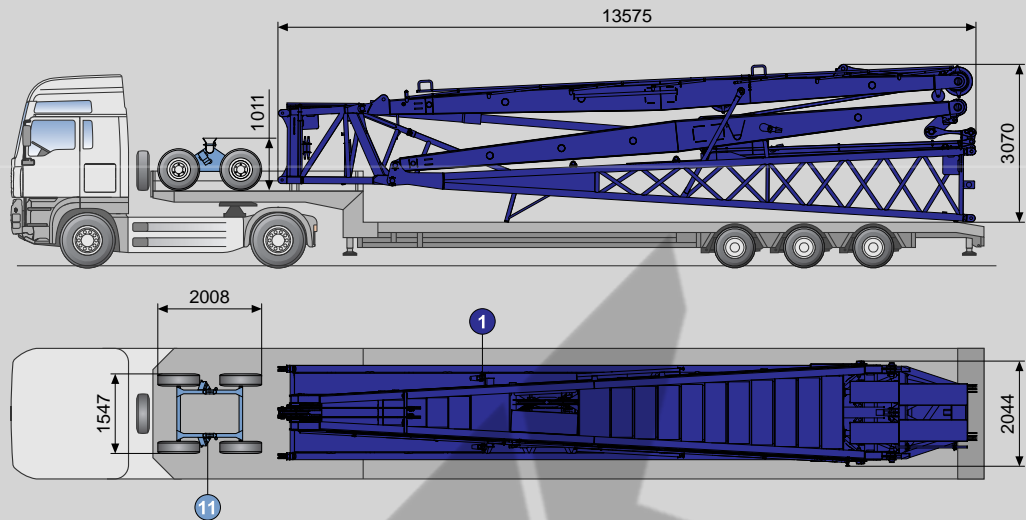

- 2 Zwischenstück
Intermediate section
Section intermédiaire
Tramo intermedio
- 4 Reduzierstück
Reducer
Adaptateur / Adaptador
conico de "LJ a FJ"
- 5 Abspannstück
Pendant connector section
Chevalet de haubanage
Arranque abatible
- 6 Zwischenstück
Intermediate section
Section intermédiaire
Tramo intermedio
- 7 Zwischenstück
Intermediate section
Section intermédiaire
Tramo intermedio
- 8 Auslegerspitze
Jib top section
Fléchette
Punta de plumín

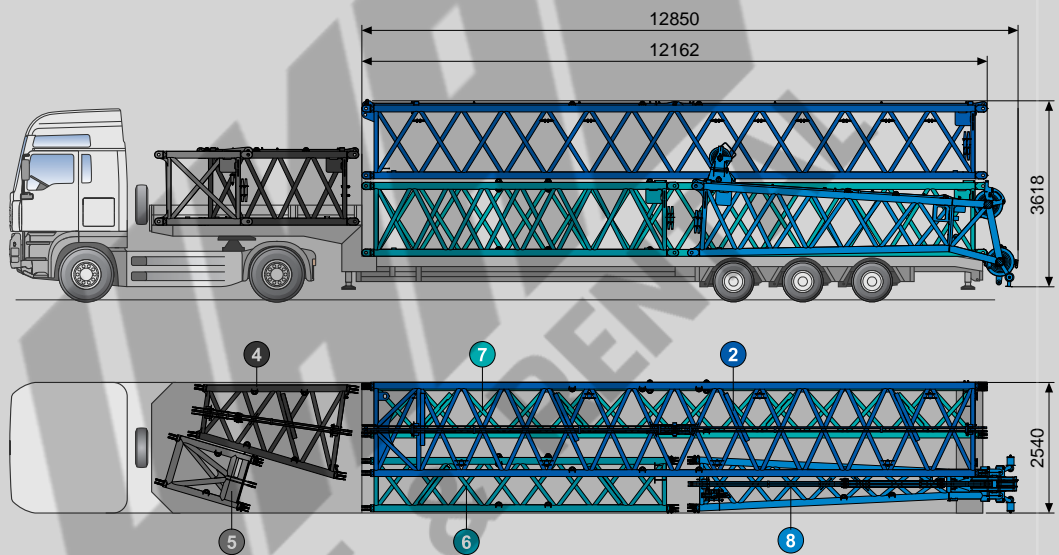

- 3 Zwischenstück
Intermediate section
Section intermédiaire
Tramo intermedio
- 12 Wippenverstelleinheit
(Hubwerk 2 und einge-
scherter Rollenträger)
Luffing assembly (Hoist 2
with reeved sheave set)
Unité pour réglage de la
volée variable (2ième treuil
avec support des poulies)
Sección intermedia,
portapoleas 2º cabestrante

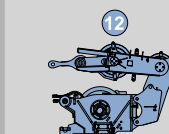

Gewicht / Weight /
Poid / Peso: 5704 kg

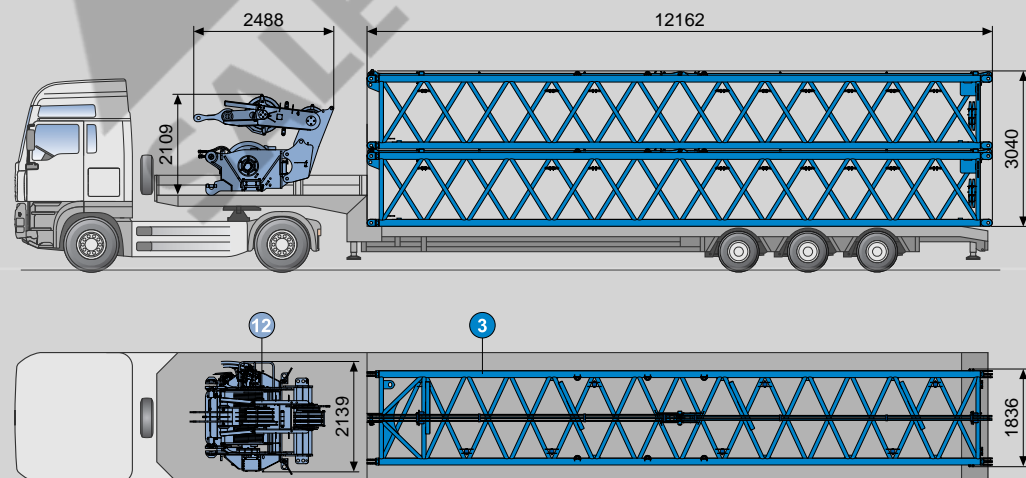

PS Transport-Beispiel + Maße (mm)
 PS Transport example + dimensions (mm)
 PS Exemple de transport + dimensions (mm)
 PS Ejemplo de transportes + dimensiones (mm)

1 Power-System (PS)

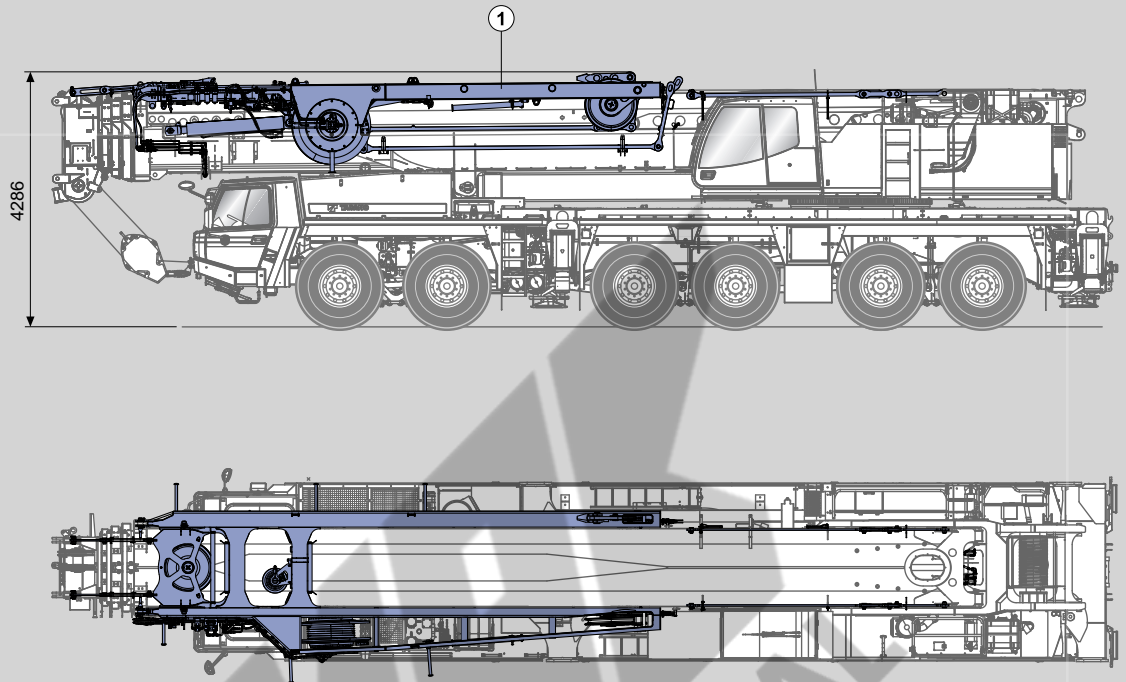

1 Power-System (PS)

Maße (mm)
 Dimensions (mm)
 Dimensiones (mm)
 Transportgewicht
 Transport weight
 Transport de poids
 Transporte de peso
 6790 kg

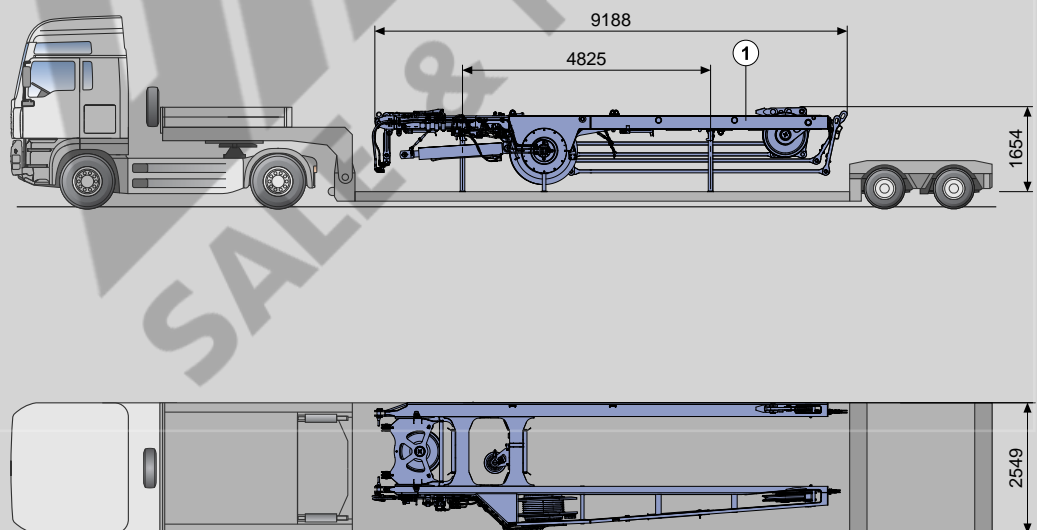

Gegengewichtvarianten
Counterweight versions
Variations des contrepoids
Variaciones de contrapeso

Gesamtgewicht Total weight Poids total Peso total	Gegengewicht / Counterweight / Contrepoids / Contrapeso					
	7.5 t ①	9 t ②	8.5 t ③	11 t ④	11 t ⑤	10 t ⑥
138 t	1	1	1	2	1	8
118 t	1	1	1	2	1	6
98 t	1	1	1	2	1	4
78 t	1	1	1	2	1	2
58 t	1	1	1	2	1	
47 t	1	1	1	2		
25 t	1	1	1			
16.5 t	1	1				
7.5 t	1					

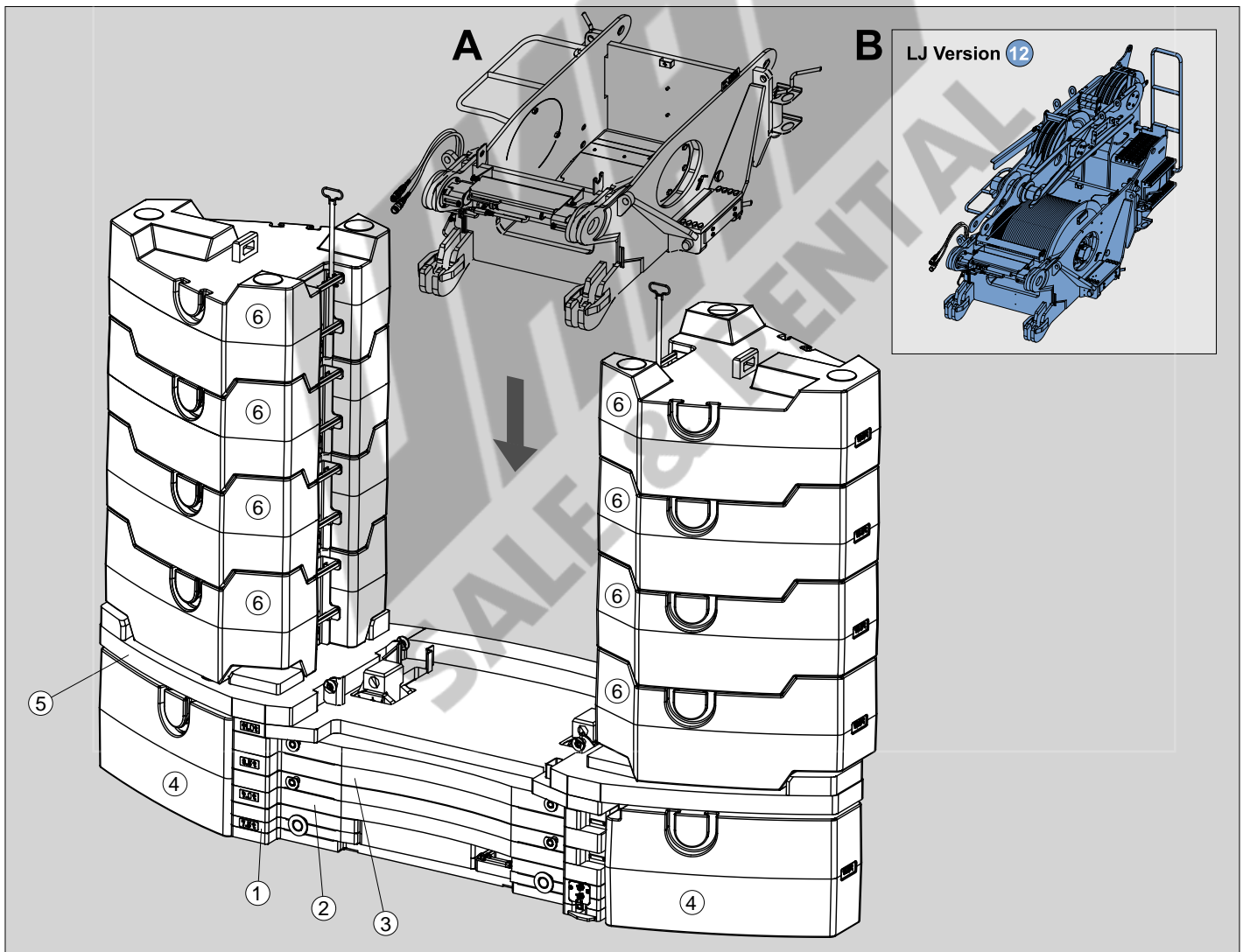
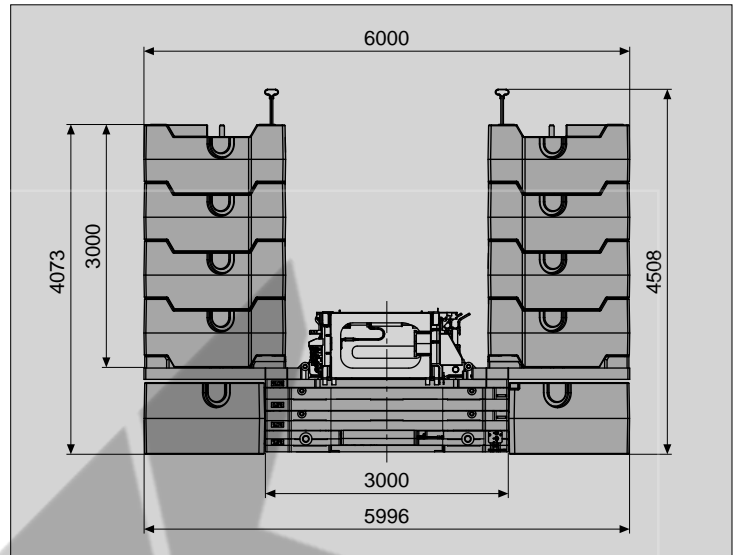

Gegengewichtvarianten
Counterweight versions
Variations des contrepoids
Variaciones de contrapeso

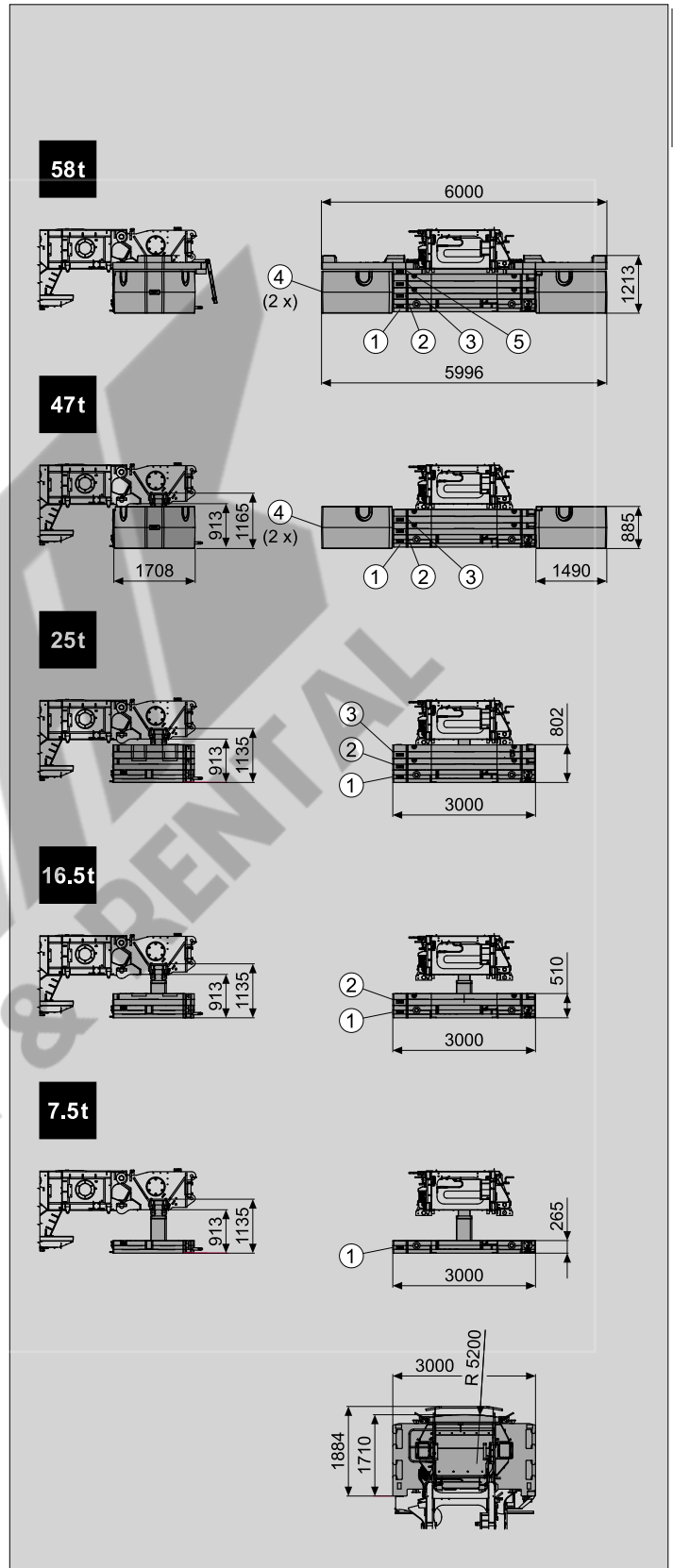
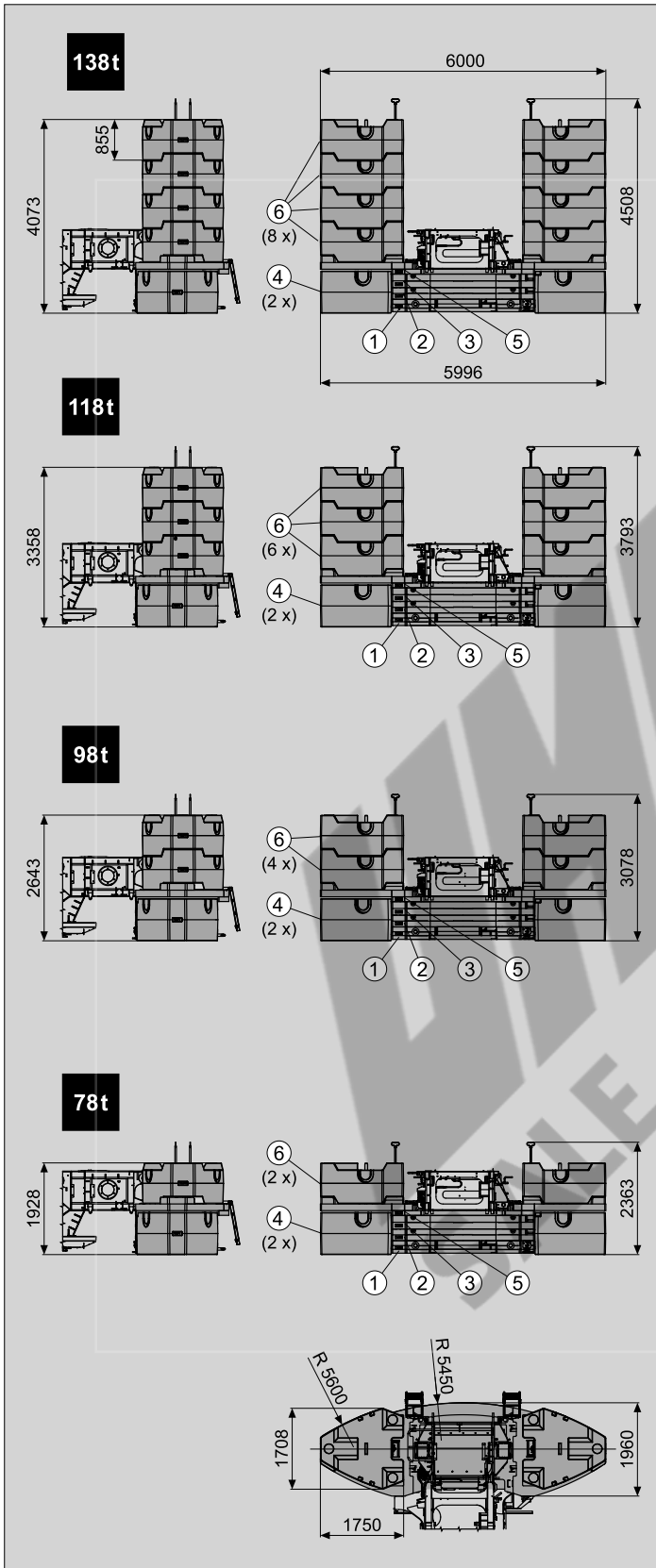

Maße (mm)
 Dimensions (mm)
 Dimensiones (mm)

445/95 R 25
 (16.00 R 25)

DIN/ISO/EN

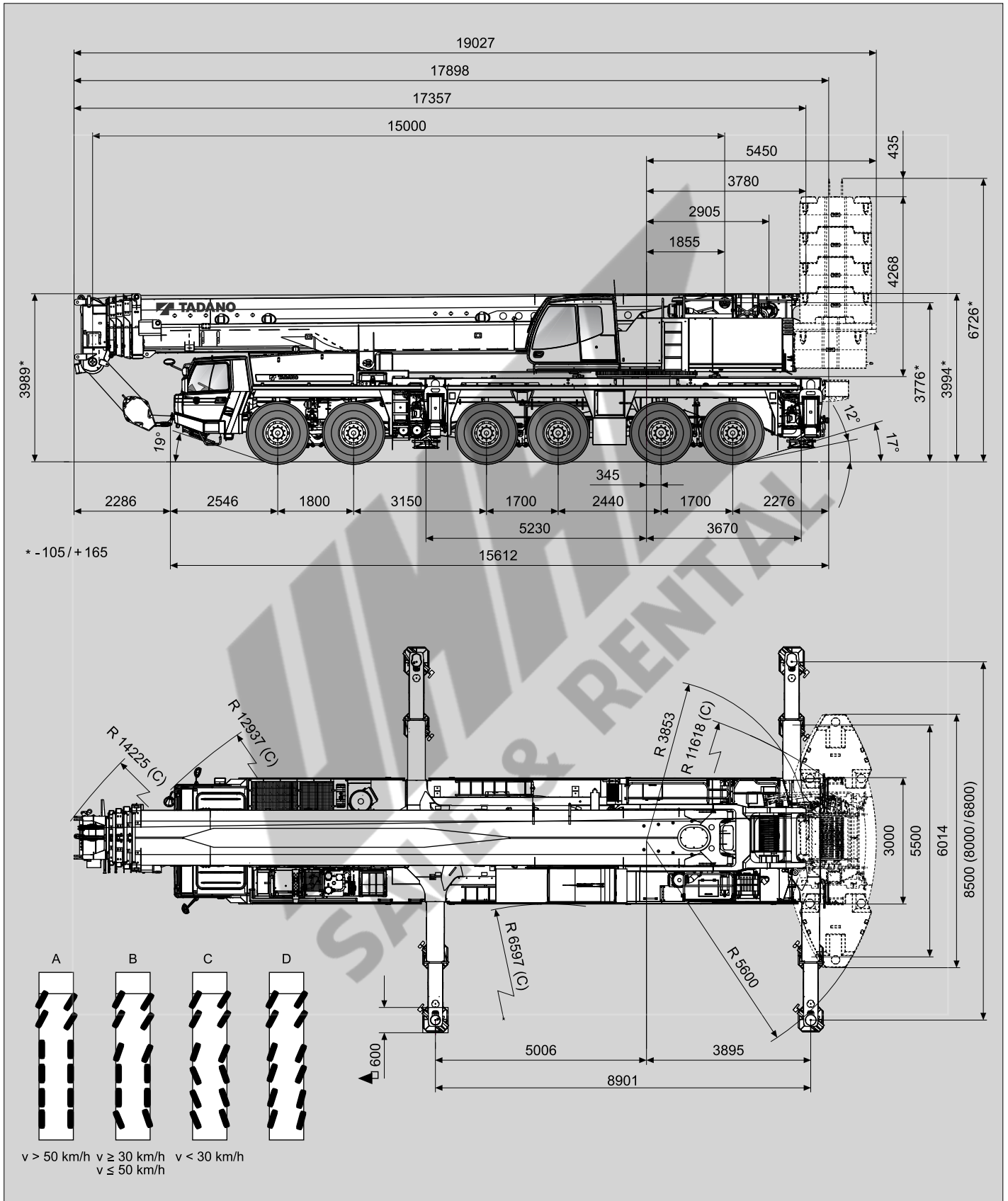

Gewichte / Geschwindigkeiten
Weights / Working speeds
Poids / Vitesses
Pesos / Velocidades de trabajo

	Achse / Axle Essieu / Eje	1	2	3	4	5	6	Gesamtgewicht / Total weight Poids total / Peso total
	(t)	12	12	12	12	12	12	

* Incl. 12,5 t Hakengeschrir, Werkzeugkasten, Antrieb 12 x 8 x 12, Bereifung 445/95 R 25 (16.00 R 25).

* Incl. 12,5 t swivel hook, toolbox, drive 12 x 8 x 12, tyres 445/95 R 25 (16.00 R 25).

* Incl. 12,5 t elingues, boîte à outils, entraînement 12 x 8 x 12, pneus 445/95 R 25 (16.00 R 25).

* Incl. 12,5 t gancho de bola, caja de herramientas, tracción 12 x 8 x 12, neumáticos 445/95 R 25 (16.00 R 25).

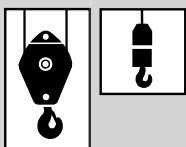
	Traglast / Lifting capacity / Force de levage / Capacidad de elevación	Rollen / Sheaves Pulies / Poleas	Stränge / Parts of line Brins / Ramales de cable	Gewicht / Weight Poid / Peso
	250 t*	9	19	1800 kg
200 t*	7	15	1600 kg	
160 t*	5	11	1400 kg	
100 t*	3	7	1300 kg	
40 t	1	3	600 kg/800 kg	
12,5 t	–	1	410 kg	





* Doppelhaken

* Rams horn

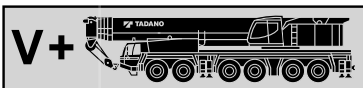
* Moufle avec crochet marin



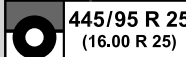



* Gancho doble



	1	2	3	4	5	6	7	8	9	10	11	12	R1	R2	
km/h	3.6	4.6	5.9	7.6	9.6	12.3	16.3	20.9	27.0	34.6	43.9	56.3	3.9	4.9	54.9%
	5.5	7.0	9.1	11.7	14.8	19.0	25.1	32.1	41.6	53.3	67.5	85.0	5.9	7.6	54.9%
	3.9	5.0	6.4	8.3	10.5	13.4	17.7	22.7	29.4	37.7	47.7	61.2	4.2	5.4	53.5%*
km/h	6.0	7.7	9.9	12.7	16.1	20.6	27.3	35.0	45.2	58.0	73.5	85.0	6.5	8.3	49.2%
	6.0	7.7	9.9	12.7	16.1	20.6	27.3	35.0	45.2	58.0	73.5	85.0	6.5	8.3	49.2%

* Mit Geländeübersetzung
* Off road range

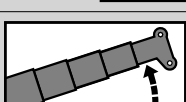
* Avec mode tout terrain
* Con transmisión todo terreno

V+ 	Stufenlos Infinitely variable Progressivement variable Infinitamente variable	Seil Rope Câble Cable	Max. Seilzug Max. single line pull Effort maxi au brin simple Trio máximo por ramal
	0 - 125 m/min für einfachen Strang single line au brin simple ramal simple	23 mm / 350 m	120 kN
	0 - 125 m/min für einfachen Strang single line au brin simple ramal simple	23 mm / 580 m	120 kN
	0 - 1.1 min ⁻¹		
	- 0,8° - + 83,5° ca. 50 s approx. 50 s env. 50 s aproximadamente 50 s		
	15.0 m - 60.0 m ca. 500 s approx. 500 s env. 500 s aproximadamente 500 s		

Hubhöhen
Lifting heights
Hauteurs de levage
Alturas de elevación

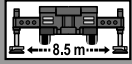
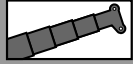

138t

DIN / ISO / EN

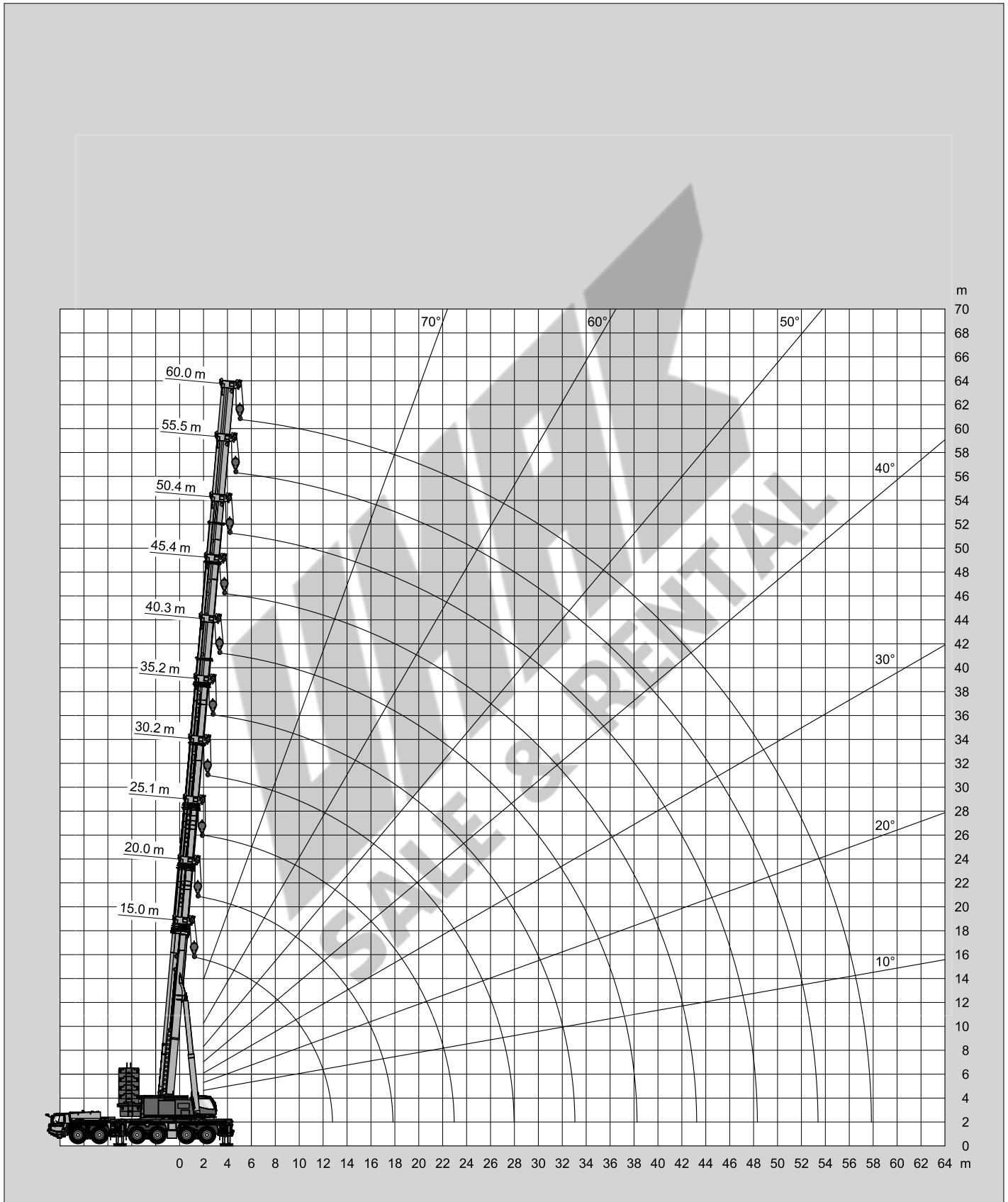

Tragfähigkeiten
Lifting capacities
Capacités de levage
Capacidades de elevación

138t **118t** ¹⁾

DIN/ISO/EN

m	15.0 m*	15.0 m	20.0 m	25.1 m	30.2 m	35.2 m	40.3 m	45.4 m	50.4 m	55.5 m	60.0 m
2.7	400.0***										
3.0	360.0**	1) 200.0	170.0	162.0							
3.5	307.0**	200.0	170.0	162.0							
4.0	264.6**	200.0	170.0	162.0	139.0						
4.5	230.0**	194.6	170.0	162.0	139.0						
5.0	200.6**	182.4	170.0	162.0	139.0	123.4					
6.0		163.8	161.4	160.8	139.0	113.8	84.1				
7.0		147.0	146.8	146.3	127.9	103.1	84.1	71.5			
8.0		132.4	132.0	131.3	118.2	94.2	84.1	71.5			
9.0		119.8	119.4	118.8	109.8	86.7	79.5	69.5	54.2		
10.0		109.2	108.8	108.1	102.6	81.2	73.6	65.7	54.2	45.0	
11.0		100.2	99.8	99.7	96.3	76.5	68.5	62.4	54.0	45.0	38.0
12.0		91.0	91.9	91.9	90.7	72.3	64.0	59.3	50.9	44.6	38.0
14.0			79.1	79.0	79.2	65.3	56.5	52.7	45.6	40.4	38.0
16.0			69.1	69.0	69.1	59.5	50.5	47.1	41.3	36.9	35.0
18.0			45.9	60.9	61.0	54.8	45.6	42.6	37.6	33.9	32.3
20.0				55.0	54.3	50.8	41.6	38.8	34.6	31.4	29.5
22.0				44.4	48.6	47.3	38.1	35.5	32.0	29.0	27.1
24.0					43.9	44.4	35.2	32.7	29.7	26.9	25.0
26.0					38.2	40.3	32.6	30.3	27.7	25.1	23.2
28.0					26.9	36.4	30.4	28.3	26.0	23.5	21.6
30.0						33.1	28.3	26.4	24.5	22.1	20.2
32.0						26.9	26.3	24.8	23.1	20.8	18.9
34.0							24.5	23.5	21.9	19.6	17.8
36.0							22.9	22.3	20.8	18.6	16.6
38.0							16.4	20.9	19.6	17.7	15.5
40.0								19.7	18.4	16.8	14.5
42.0								17.8	17.3	16.1	13.5
44.0									16.3	15.4	12.7
46.0									15.4	14.7	11.9
48.0									12.8	14.0	11.2
50.0										13.2	10.5
52.0										12.5	9.9
54.0											9.4
56.0											8.9
58.0											7.1

MB

1) 360° Traglasten < 8 m Arbeitsradius max. 118 t Gegengewicht / 360° Lifting capacities < 8 m working radius max. 118 t counterweight / 360° forces de levage < 8 m portée max. 118 t contrepoids / 360° capacidades de elevación < 8 m radio de giro max. 118 t contrapeso
 *) Arbeitsbereich 0° / Working area 0° / Limitation de zone 0° / Limitación del área 0°
 **) Mit Schwerlasteinrichtung 1, Zentralabstützung und Zusatzrollen / With heavy duty attachment 1, center support and additional sheaves
 ***) Mit Schwerlasteinrichtung 2, Zentralabstützung, Zusatzrollen und Hubwerk 2 / With heavy duty attachment 2, center support, additional sheaves and auxiliary winch

Tragfähigkeiten
Lifting capacities
Capacités de levage
Capacidades de elevación

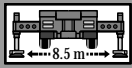
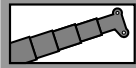

118t

DIN/ISO/EN

 m	15.0 m	20.0 m	25.1 m	30.2 m	35.2 m	40.3 m	45.4 m	50.4 m	55.5 m	60.0 m
3.0	200.0	170.0	162.0							
3.5	200.0	170.0	162.0							
4.0	200.0	170.0	162.0	139.0						
4.5	194.6	170.0	162.0	139.0						
5.0	182.4	170.0	162.0	139.0	123.4					
6.0	161.8	161.4	160.8	139.0	113.8	84.1				
7.0	143.5	143.2	142.5	127.9	103.1	84.1	71.5			
8.0	128.6	128.3	127.6	118.2	94.2	84.1	71.5	54.2		
9.0	116.2	115.9	115.1	109.8	86.7	79.5	69.5	54.2	45.0	
10.0	105.8	105.4	105.4	102.6	81.2	73.6	65.7	54.2	45.0	38.0
11.0	96.9	96.5	96.4	96.3	76.5	68.5	62.4	54.0	45.0	38.0
12.0	89.3	88.8	88.7	88.9	72.3	64.0	59.3	50.9	44.6	38.0
14.0		76.2	76.1	76.3	65.3	56.5	52.7	45.6	40.4	38.0
16.0		66.0	65.8	66.0	59.5	50.5	47.1	41.3	36.9	35.0
18.0		45.9	58.2	57.3	54.8	45.6	42.6	37.6	33.9	32.3
20.0			50.3	49.4	50.5	41.6	38.8	34.6	31.4	29.5
22.0			44.2	43.2	44.2	38.1	35.5	32.0	29.0	27.1
24.0				40.1	39.1	35.2	32.7	29.7	26.9	25.0
26.0				36.0	35.0	32.6	30.3	27.7	25.1	23.2
28.0				26.9	31.5	30.4	28.3	26.0	23.5	21.6
30.0					28.6	27.8	26.4	24.5	22.1	20.2
32.0					26.1	25.2	24.8	23.1	20.8	18.9
34.0						23.0	23.5	21.9	19.6	17.8
36.0						21.0	21.8	20.8	18.6	16.6
38.0						16.4	20.0	19.6	17.7	15.5
40.0							18.4	18.3	16.8	14.5
42.0							17.0	16.9	16.1	13.5
44.0								15.6	15.4	12.7
46.0								14.5	14.7	11.9
48.0								12.8	13.7	11.2
50.0									12.8	10.5
52.0									11.9	9.9
54.0										9.4
56.0										8.9
58.0										7.1

SALE & RENTAL

Tragfähigkeiten
Lifting capacities
Capacités de levage
Capacidades de elevación

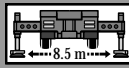
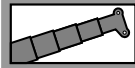

98t

DIN/ISO/EN

→ m	15.0 m	20.0 m	25.1 m	30.2 m	35.2 m	40.3 m	45.4 m	50.4 m	55.5 m	60.0 m
3.0	200.0	170.0	162.0							
3.5	200.0	170.0	162.0							
4.0	200.0	170.0	162.0	139.0						
4.5	192.4	170.0	162.0	139.0						
5.0	179.8	170.0	162.0	139.0	123.4					
6.0	157.2	156.8	156.2	139.0	113.8	84.1				
7.0	139.2	138.8	138.1	127.9	103.1	84.1	71.5			
8.0	124.5	124.1	123.4	118.2	94.2	84.1	71.5	54.2		
9.0	112.3	111.9	111.8	109.8	86.7	79.5	69.5	54.2	45.0	
10.0	102.0	101.6	101.6	101.8	81.2	73.6	65.7	54.2	45.0	38.0
11.0	93.1	92.6	92.5	92.8	76.5	68.5	62.4	54.0	45.0	38.0
12.0	85.1	84.6	84.6	84.8	72.3	64.0	59.3	50.9	44.6	38.0
14.0		70.7	71.7	70.8	65.3	56.5	52.7	45.6	40.4	38.0
16.0		58.3	59.1	58.2	59.4	50.5	47.1	41.3	36.9	35.0
18.0		45.9	50.0	50.0	50.2	45.6	42.6	37.6	33.9	32.3
20.0			43.0	44.1	43.2	41.6	38.8	34.6	31.4	29.5
22.0			37.8	38.6	37.7	37.0	35.5	32.0	29.0	27.1
24.0				34.2	33.2	32.6	32.7	29.7	26.9	25.0
26.0				30.6	29.6	28.9	29.3	27.7	25.1	23.2
28.0				26.9	26.6	25.7	26.6	26.0	23.5	21.6
30.0					23.9	23.0	23.9	23.9	22.1	20.2
32.0					21.7	20.7	21.5	21.5	20.8	18.9
34.0						18.7	19.5	19.5	19.6	17.8
36.0						17.0	17.7	17.7	18.0	16.6
38.0						15.5	16.2	16.4	16.5	15.5
40.0							14.8	15.6	15.1	14.5
42.0							13.6	14.5	13.8	13.5
44.0								13.4	12.7	12.7
46.0								12.5	11.7	11.7
48.0								11.6	10.8	10.8
50.0									9.9	9.9
52.0									9.2	9.2
54.0										8.5
56.0										7.8
58.0										7.1

MB

Tragfähigkeiten
Lifting capacities
Capacités de levage
Capacidades de elevación

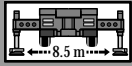
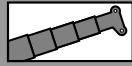

78t

DIN/ISO/EN

→ m	15.0 m	20.0 m	25.1 m	30.2 m	35.2 m	40.3 m	45.4 m	50.4 m	55.5 m	60.0 m
3.0	200.0	170.0	162.0							
3.5	200.0	170.0	162.0							
4.0	200.0	170.0	162.0	139.0						
4.5	188.1	170.0	162.0	139.0						
5.0	174.7	170.0	162.0	139.0	123.4					
6.0	152.3	152.0	151.3	139.0	113.8	84.1				
7.0	134.5	134.1	133.5	127.9	103.1	84.1	71.5			
8.0	120.0	119.6	119.6	118.2	94.2	84.1	71.5	54.2		
9.0	107.4	106.9	106.9	107.1	86.7	79.5	69.5	54.2	45.0	
10.0	96.6	96.2	96.2	95.4	81.2	73.6	65.7	54.2	45.0	38.0
11.0	86.8	86.2	87.3	84.5	76.5	68.5	62.4	54.0	45.0	38.0
12.0	76.0	75.4	76.4	75.5	72.3	64.0	59.3	50.9	44.6	38.0
14.0		59.7	60.6	60.2	61.0	56.5	52.7	45.6	40.4	38.0
16.0		50.8	49.7	51.0	50.1	49.3	47.1	41.3	36.9	35.0
18.0		43.1	43.3	43.0	42.1	41.5	41.7	37.6	33.9	32.3
20.0			37.3	37.0	36.1	35.4	35.9	34.6	31.4	29.5
22.0			32.7	32.2	31.3	30.5	31.5	31.5	29.0	27.1
24.0				28.3	27.3	26.5	27.4	27.5	26.9	25.0
26.0				25.1	24.0	23.2	24.1	24.1	24.5	23.2
28.0				22.5	21.3	20.5	21.3	22.0	21.7	21.6
30.0					19.0	18.3	19.0	20.1	19.4	19.5
32.0					17.1	17.3	17.6	18.1	17.4	17.5
34.0						16.4	16.6	16.3	15.6	15.7
36.0						15.6	15.3	14.8	14.1	14.2
38.0						14.6	13.9	13.4	12.7	12.8
40.0							12.8	12.2	11.5	11.6
42.0							11.7	11.2	10.4	10.5
44.0								10.2	9.4	9.5
46.0								9.4	8.6	8.6
48.0								8.6	7.8	7.8
50.0									7.1	7.1
52.0									6.5	6.4
54.0										5.8
56.0										5.3
58.0										4.8

Tragfähigkeiten
Lifting capacities
Capacités de levage
Capacidades de elevación

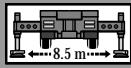
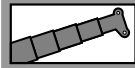

58t

DIN/ISO/EN

 m	15.0 m	20.0 m	25.1 m	30.2 m	35.2 m	40.3 m	45.4 m	50.4 m	55.5 m	60.0 m
3.0	200.0	170.0	162.0							
3.5	200.0	170.0	162.0							
4.0	197.5	170.0	162.0	139.0						
4.5	182.3	170.0	162.0	139.0						
5.0	169.0	168.7	162.0	139.0	123.4					
6.0	146.9	146.5	145.9	139.0	113.8	84.1				
7.0	128.6	128.2	128.2	123.4	103.1	84.1	71.5			
8.0	113.2	112.8	110.0	103.4	94.2	84.1	71.5	54.2		
9.0	99.1	98.5	95.0	88.5	85.6	79.5	69.5	54.2	45.0	
10.0	83.2	82.6	82.5	77.1	75.1	70.6	65.7	54.2	45.0	38.0
11.0	71.3	70.8	71.9	70.9	66.6	62.8	60.8	54.0	45.0	38.0
12.0	62.2	63.7	62.7	63.5	59.7	56.3	54.8	50.9	44.6	38.0
14.0		50.4	50.9	50.7	49.1	46.3	45.9	44.4	40.4	38.0
16.0		41.3	41.8	41.5	40.6	38.9	38.8	37.6	36.9	35.0
18.0		34.7	35.0	34.7	33.7	33.0	33.2	32.5	31.7	31.1
20.0			29.7	29.3	28.3	27.6	28.6	29.2	27.6	27.0
22.0			25.8	25.1	24.1	24.1	25.4	25.5	24.2	23.7
24.0				23.0	20.7	22.3	22.5	22.0	21.3	20.9
26.0				20.3	18.4	20.1	19.6	19.2	18.5	18.6
28.0				18.2	17.2	17.8	17.3	16.8	16.1	16.3
30.0					15.8	15.8	15.3	14.9	14.1	14.3
32.0					14.3	14.2	13.6	13.2	12.5	12.6
34.0						12.7	12.2	11.7	11.0	11.1
36.0						11.5	10.9	10.4	9.7	9.8
38.0						10.5	9.8	9.3	8.6	8.7
40.0							8.9	8.3	7.6	7.7
42.0							8.1	7.5	6.7	6.8
44.0								6.7	6.0	6.0
46.0								6.0	5.2	5.3
48.0								5.5	4.6	4.6
50.0									4.0	4.1
52.0									3.5	3.5
54.0										3.0
56.0										2.6
58.0										2.3

MB

Tragfähigkeiten
Lifting capacities
Capacités de levage
Capacidades de elevación



DIN/ISO/EN

 m	15.0 m	20.0 m	25.1 m	30.2 m	35.2 m	40.3 m	45.4 m	50.4 m	55.5 m	60.0 m
3.0	200.0	170.0	162.0							
3.5	200.0	170.0	162.0							
4.0	194.2	170.0	162.0	139.0						
4.5	179.1	170.0	162.0	139.0						
5.0	165.8	165.4	162.0	139.0	123.4					
6.0	143.4	143.0	142.3	133.4	113.8	84.1				
7.0	124.3	123.9	116.2	108.2	100.2	84.1	71.5			
8.0	107.9	103.4	96.2	90.4	86.8	80.9	71.5	54.2		
9.0	87.8	87.1	83.2	80.3	74.9	70.0	67.2	54.2	45.0	
10.0	73.5	73.3	72.0	70.1	65.5	61.4	59.3	54.2	45.0	38.0
11.0	62.9	64.4	64.5	61.9	58.0	54.5	53.4	51.3	45.0	38.0
12.0	54.7	56.2	56.8	55.3	51.9	48.7	48.0	46.1	44.6	38.0
14.0		44.3	44.8	44.6	42.1	39.4	39.2	39.0	37.0	36.0
16.0		35.6	36.2	35.9	34.9	32.7	33.7	33.0	31.1	30.4
18.0		29.4	30.0	29.5	28.4	28.7	29.6	28.2	26.5	26.0
20.0			25.2	25.9	23.5	26.0	25.5	24.4	22.9	22.4
22.0			21.6	22.1	21.5	22.2	21.7	21.2	19.9	19.5
24.0				19.2	19.0	19.1	18.6	18.2	17.4	17.1
26.0				16.8	16.5	16.7	16.2	15.7	15.0	15.0
28.0				15.0	14.6	14.6	14.1	13.6	12.9	13.1
30.0					12.9	12.9	12.4	11.9	11.2	11.3
32.0					11.5	11.4	10.9	10.4	9.7	9.8
34.0						10.2	9.6	9.2	8.5	8.6
36.0						9.1	8.5	8.1	7.3	7.5
38.0						8.3	7.6	7.1	6.4	6.5
40.0							6.8	6.2	5.5	5.6
42.0							6.0	5.5	4.7	4.8
44.0								4.8	4.0	4.1
46.0								4.2	3.4	3.5
48.0								3.7	2.9	2.9
50.0									2.4	2.4
52.0									2.0	2.0
54.0										1.5



DIN/ISO/EN

 m	15.0 m	20.0 m	25.1 m	30.2 m	35.2 m	40.3 m	45.4 m	50.4 m	55.5 m	60.0 m
3.0	200.0	170.0	162.0							
3.5	200.0	170.0	162.0							
4.0	187.0	170.0	162.0	139.0						
4.5	172.0	170.0	162.0	139.0						
5.0	157.6	157.2	139.6	126.6	113.4					
6.0	132.9	117.6	108.1	101.0	91.5	83.5				
7.0	101.9	91.8	88.4	81.8	74.8	68.6	65.5			
8.0	81.2	77.6	73.2	68.0	62.1	57.0	54.9	51.8		
9.0	65.6	64.7	61.3	57.1	52.4	48.8	49.4	46.2	42.9	
10.0	54.6	54.7	52.2	49.0	45.0	45.4	43.0	40.4	37.5	36.2
11.0	44.9	46.8	45.6	44.0	39.2	40.4	38.0	35.7	33.2	32.1
12.0	37.8	39.6	40.1	39.2	36.5	35.9	33.8	31.8	29.6	28.6
14.0		29.6	30.5	31.4	30.1	29.0	27.3	25.8	23.9	23.2
16.0		23.1	23.9	24.8	24.7	24.0	22.6	21.3	19.6	19.1
18.0		18.6	19.2	20.0	19.9	20.2	19.0	17.8	16.3	15.9
20.0			15.8	16.5	16.4	16.6	16.1	15.0	13.6	13.3
22.0			13.2	13.8	13.6	13.8	13.3	12.8	11.5	11.3
24.0				11.7	11.5	11.6	11.1	10.7	9.7	9.5
26.0				10.0	9.7	9.8	9.3	8.9	8.2	8.0
28.0				8.7	8.3	8.4	7.9	7.4	6.7	6.7
30.0					7.1	7.1	6.6	6.2	5.5	5.6
32.0					6.2	6.1	5.6	5.1	4.4	4.5
34.0						5.2	4.7	4.2	3.5	3.6
36.0						4.5	3.9	3.4	2.7	2.8
38.0						3.9	3.2	2.7	1.9	2.0
40.0							2.6	2.1		
42.0							2.1	1.5		

			16.5t	DIN/ISO/EN
--	---	---	--------------	-------------------

 m	15.0 m	20.0 m	25.1 m	30.2 m	35.2 m	40.3 m	45.4 m	50.4 m	55.5 m	60.0 m
3.0	200.0	170.0	162.0							
3.5	200.0	170.0	162.0							
4.0	184.0	170.0	162.0	139.0						
4.5	167.8	167.4	142.5	127.0						
5.0	153.1	137.9	123.3	112.5	100.0					
6.0	113.9	100.5	95.3	86.7	78.1	70.1				
7.0	86.9	81.3	75.4	68.8	62.0	57.7	56.4			
8.0	68.5	64.7	60.7	56.0	50.8	51.1	47.3	44.0		
9.0	55.4	53.1	50.8	48.8	45.7	43.5	40.5	37.7	34.7	
10.0	44.3	44.7	43.1	41.8	39.5	37.7	35.1	32.8	30.2	29.1
11.0	36.1	38.1	37.2	36.3	34.5	33.0	30.8	28.8	26.5	25.6
12.0	30.1	32.0	32.5	32.0	30.4	29.2	27.3	25.5	23.5	22.7
14.0		23.5	24.5	25.4	24.2	23.3	21.8	20.4	18.6	18.1
16.0		18.0	18.8	19.7	19.7	19.1	17.8	16.6	15.0	14.6
18.0		14.3	14.9	15.7	15.6	15.8	14.7	13.6	12.1	11.8
20.0			12.0	12.7	12.6	12.8	12.1	11.1	9.8	9.5
22.0			9.9	10.5	10.3	10.5	10.0	9.1	7.9	7.7
24.0				8.6	8.4	8.6	8.1	7.5	6.3	6.1
26.0				7.1	6.9	7.0	6.5	6.0	5.0	4.9
28.0				6.1	5.6	5.7	5.2	4.7	3.9	3.8
30.0					4.6	4.6	4.1	3.6	2.9	2.8
32.0					3.9	3.7	3.2	2.7		
34.0						3.0	2.4	1.9		
36.0						2.4	1.8			
38.0						1.9				

MB

			7.5t	DIN/ISO/EN
--	---	---	-------------	-------------------

 m	15.0 m	20.0 m	25.1 m	30.2 m	35.2 m	40.3 m	45.4 m	50.4 m	55.5 m	60.0 m
3.0	200.0	170.0	162.0							
3.5	198.0	170.0	162.0							
4.0	179.8	170.0	162.0	139.0						
4.5	162.8	139.7	122.3	109.9						
5.0	134.2	114.4	105.5	93.8	82.0					
6.0	94.1	86.1	77.8	69.6	61.4	60.2				
7.0	69.0	64.3	60.0	56.4	52.0	48.5	44.3			
8.0	53.0	50.6	48.0	45.8	42.7	40.1	36.9	34.1		
9.0	42.5	41.2	39.6	38.2	35.8	33.9	31.3	29.0	26.3	
10.0	33.7	34.3	33.3	32.5	30.6	29.2	27.0	25.0	22.6	21.7
11.0	27.1	29.1	28.5	28.1	26.5	25.3	23.5	21.6	19.3	18.6
12.0	22.2	24.1	24.7	24.5	23.2	22.1	20.3	18.6	16.6	16.0
14.0		17.3	18.2	18.7	17.7	17.0	15.5	14.2	12.5	12.1
16.0		12.4	13.4	14.3	13.8	13.3	12.1	10.9	9.5	9.1
18.0		9.3	10.0	10.8	10.8	10.6	9.5	8.5	7.1	6.9
20.0			7.6	8.3	8.2	8.5	7.5	6.6	5.3	5.1
22.0			5.8	6.4	6.3	6.5	5.9	5.0	3.8	
24.0				5.0	4.8	5.0	4.4	3.7		
26.0				3.9	3.6	3.7	3.2			
28.0				3.1	2.7	2.7	2.2			
30.0					1.9	1.9				

Tragfähigkeiten
Lifting capacities
Capacités de levage
Capacidades de elevación



→ m	15.0 m	20.0 m	25.1 m	30.2 m	35.2 m	40.3 m	45.4 m	50.4 m	55.5 m	60.0 m
3.0	200.0	170.0	162.0							
3.5	195.1	170.0	162.0							
4.0	175.4	156.6	139.0	127.0						
4.5	148.3	122.9	111.1	97.0						
5.0	117.9	104.5	93.0	80.6	69.2					
6.0	80.1	72.8	66.4	61.2	55.5	50.9				
7.0	57.4	54.0	50.5	47.6	43.8	40.7	37.1			
8.0	43.7	42.1	40.2	38.5	35.8	33.5	30.7	28.0		
9.0	34.7	34.0	32.9	31.9	29.8	28.1	25.5	23.1	20.4	
10.0	27.2	28.0	27.3	26.7	24.9	23.5	21.3	19.3	17.0	16.2
11.0	21.6	22.9	22.7	22.4	21.0	19.9	18.0	16.3	14.3	13.6
12.0	16.9	19.1	19.1	19.0	17.9	17.0	15.4	13.9	12.0	11.5
14.0		12.6	13.8	14.1	13.3	12.7	11.4	10.1	8.6	8.2
16.0		8.6	9.6	10.6	10.1	9.6	8.5	7.5	6.1	5.8
18.0		6.1	6.8	7.7	7.6	7.4	6.4	5.4		
20.0			4.8	5.6	5.5	5.6	4.7	3.8		
22.0			3.4	4.0	3.9	4.1	3.4			
24.0				2.8	2.6	2.8				
26.0				1.9	1.7	1.8				



→ m	15.0 m	20.0 m	25.1 m	30.2 m	35.2 m	40.3 m	45.4 m	50.4 m	55.5 m	60.0 m
3.0	200.0	170.0	162.0							
3.5	190.8	170.0	162.0							
4.0	171.0	156.6	139.0	127.0						
4.5	135.6	113.6	97.1	83.1						
5.0	103.3	90.3	79.4	72.1	64.2					
6.0	68.3	62.9	57.8	53.7	48.8	45.0				
7.0	49.7	47.2	44.5	42.1	38.9	36.2	33.0			
8.0	38.2	37.1	35.6	34.2	31.8	29.9	27.3	25.0		
9.0	30.3	30.0	29.2	28.4	26.6	25.2	23.0	21.1	18.8	
10.0	23.7	24.8	24.4	24.1	22.6	21.5	19.7	18.0	16.0	15.3
11.0	18.8	20.8	20.7	20.6	19.4	18.5	16.9	15.4	13.6	13.1
12.0	15.1	17.0	17.8	17.8	16.8	16.1	14.6	13.3	11.7	11.2
14.0		11.8	12.8	13.6	12.9	12.3	11.1	10.0	8.6	8.2
16.0		8.3	9.2	10.1	10.0	9.6	8.5	7.5	6.1	5.8
18.0		6.0	6.7	7.5	7.4	7.4	6.4	5.4		
20.0			4.8	5.6	5.5	5.6	4.7	3.8		
22.0			3.4	4.0	3.9	4.0	3.4			
24.0				2.8	2.6	2.8				
26.0				1.9	1.7	1.8				



UNOFFICIAL
SALE & RENTAL

Hubhöhen
Lifting heights
Hauteurs de levage
Alturas de elevación

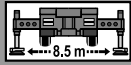
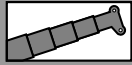

138t

DIN / ISO / EN

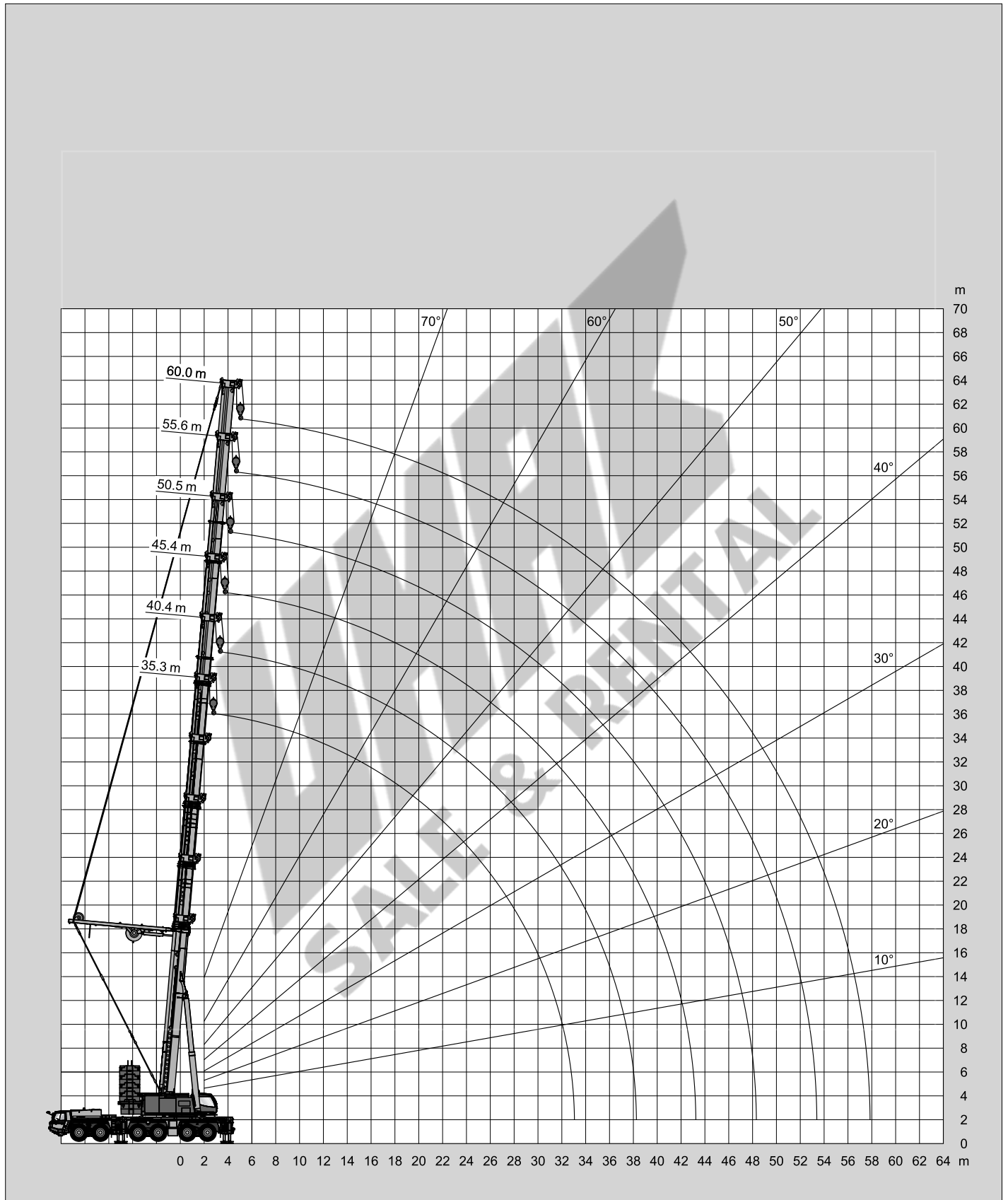

Tragfähigkeiten
Lifting capacities
Capacités de levage
Capacidades de elevación



→ m	35.2 m	40.3 m	45.4 m	50.4 m	55.5 m	60.0 m
6.0	118.0	84.1				
7.0	112.5	84.1	68.0			
8.0	101.4	84.1	68.0	58.0		
9.0	93.8	84.1	68.0	58.0	45.0	
10.0	86.3	82.4	68.0	58.0	45.0	34.9
11.0	79.5	76.8	68.0	58.0	45.0	34.7
12.0	74.5	71.1	68.0	58.0	44.7	34.5
14.0	65.3	62.7	59.9	58.0	44.4	34.2
16.0	58.0	55.5	53.7	51.5	44.0	33.7
18.0	52.4	50.2	48.0	46.7	43.7	33.4
20.0	47.5	45.5	43.9	42.5	41.2	33.0
22.0	43.5	41.5	40.0	39.0	37.7	32.7
24.0	40.0	38.4	36.9	35.7	34.7	32.4
26.0	36.5	35.5	34.0	33.2	32.2	31.2
28.0	32.9	33.0	31.6	30.7	30.0	29.1
30.0	29.6	30.7	29.5	28.8	28.1	27.1
32.0	22.3	27.7	27.6	27.1	26.2	25.5
34.0		25.1	25.8	25.3	24.7	23.7
36.0		21.4	23.6	24.0	23.3	22.6
38.0		13.4	21.6	22.5	22.1	21.2
40.0			19.7	20.7	21.0	20.2
42.0			14.8	19.0	19.8	19.2
44.0				17.5	18.2	18.2
46.0				15.1	16.9	16.9
48.0				9.9	15.6	15.7
50.0					14.5	14.5
52.0					11.2	13.5
54.0						12.5
56.0						9.9
58.0						4.7

MB + PS

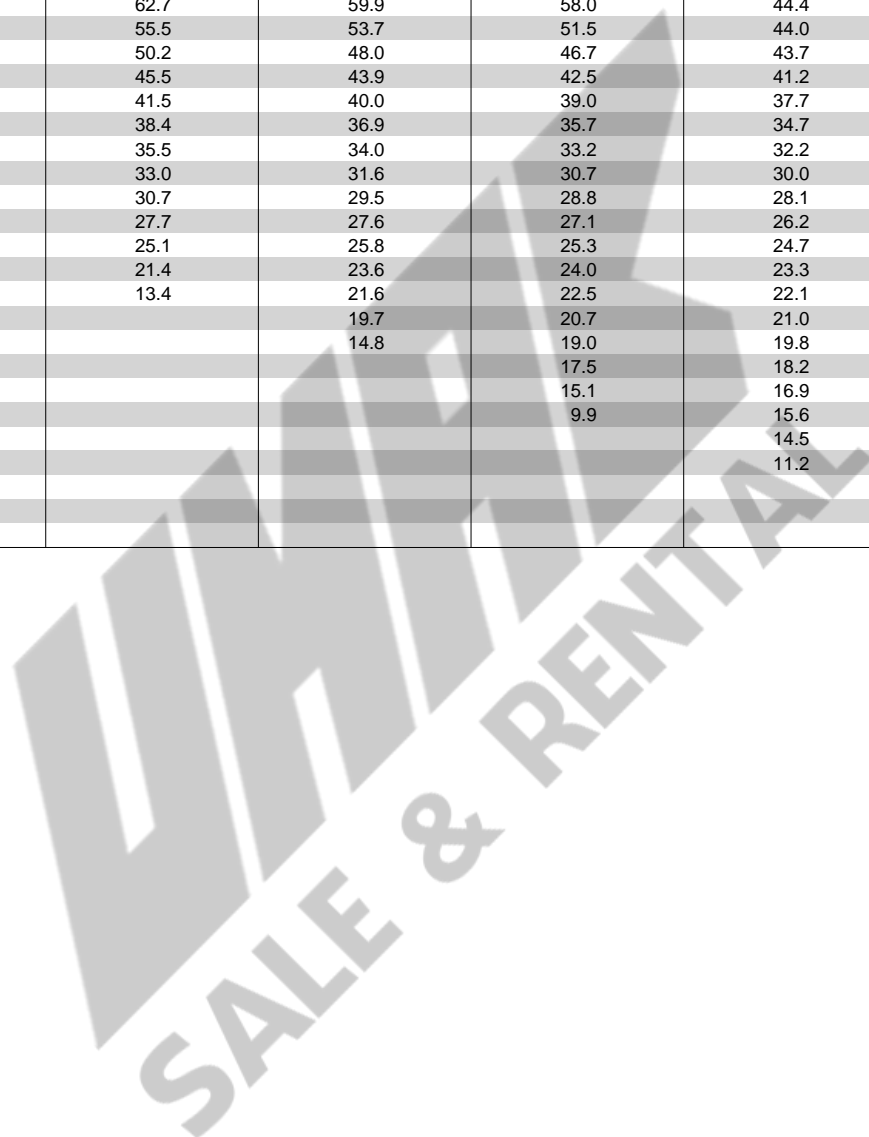

Tragfähigkeiten
Lifting capacities
Capacités de levage
Capacidades de elevación



 m	35.2 m	40.3 m	45.4 m	50.4 m	55.5 m	60.0 m
4.0	118.0					
4.5	118.0					
5.0	118.0					
6.0	118.0	84.1				
7.0	112.5	84.1	68.0			
8.0	101.4	84.1	68.0	58.0		
9.0	93.8	84.1	68.0	58.0	45.0	
10.0	86.3	82.4	68.0	58.0	45.0	34.9
11.0	79.5	76.8	68.0	58.0	45.0	34.7
12.0	74.5	71.1	68.0	58.0	44.7	34.5
14.0	65.3	62.7	59.9	58.0	44.4	34.2
16.0	58.0	55.5	53.7	51.5	44.0	33.7
18.0	52.4	50.2	48.0	46.7	43.7	33.4
20.0	47.5	45.5	43.9	42.5	41.2	33.0
22.0	41.3	41.5	40.0	39.0	37.7	32.7
24.0	36.0	37.2	36.9	35.7	34.7	32.4
26.0	31.7	32.9	33.7	33.2	32.2	31.2
28.0	28.1	29.3	30.0	30.7	30.0	29.1
30.0	25.0	26.2	26.9	27.8	28.1	27.1
32.0	22.3	23.4	24.3	25.2	25.9	25.5
34.0		21.0	21.8	22.8	23.6	23.7
36.0		18.9	19.7	20.7	21.5	21.6
38.0		13.4	17.8	18.8	19.6	19.7
40.0			16.2	17.1	17.9	18.0
42.0			14.7	15.6	16.4	16.5
44.0				14.3	15.0	15.1
46.0				13.0	13.8	13.9
48.0				9.9	12.7	12.8
50.0					11.7	11.7
52.0					10.7	10.8
54.0						10.0
56.0						9.2
58.0						4.7

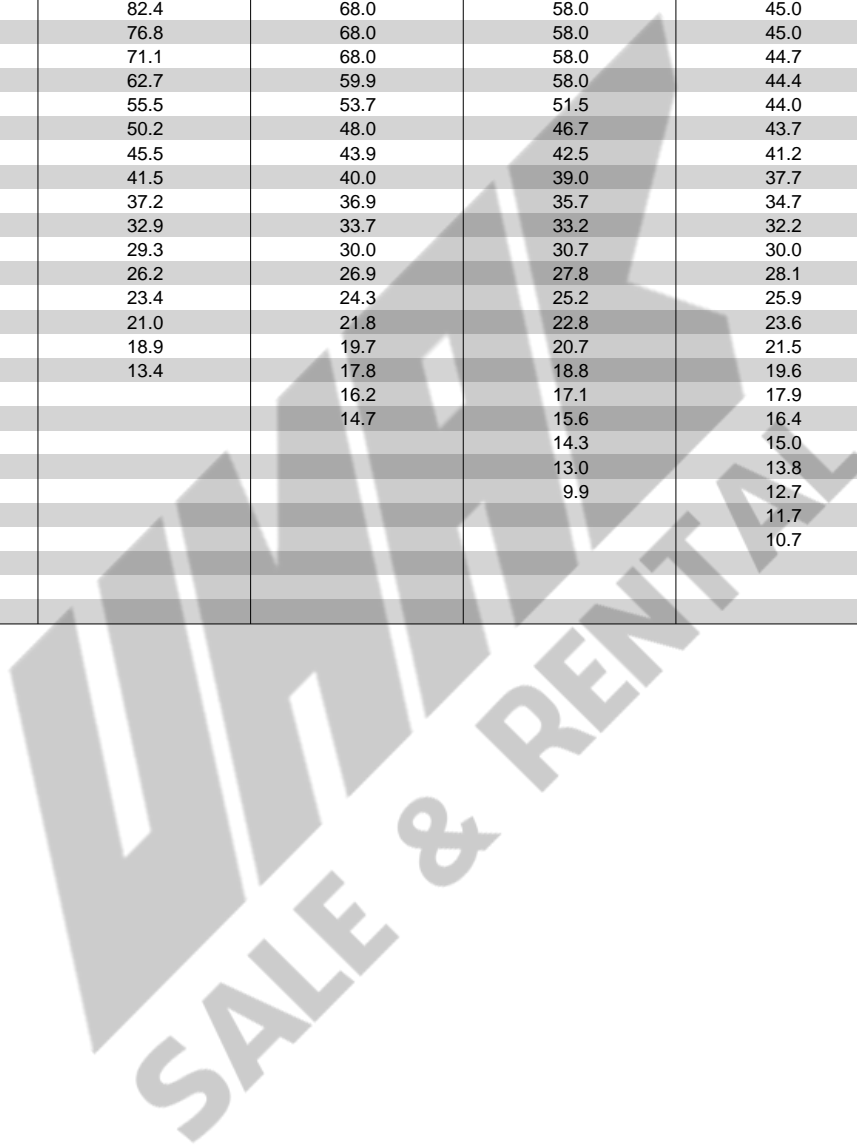

Tragfähigkeiten
Lifting capacities
Capacités de levage
Capacidades de elevación



→ m	35.2 m	40.3 m	45.4 m	50.4 m	55.5 m	60.0 m
4.0	118.0					
4.5	118.0					
5.0	118.0					
6.0	118.0	84.1				
7.0	112.5	84.1	68.0			
8.0	101.4	84.1	68.0	58.0		
9.0	93.8	84.1	68.0	58.0	45.0	
10.0	86.3	82.4	68.0	58.0	45.0	34.9
11.0	79.5	76.8	68.0	58.0	45.0	34.7
12.0	74.5	71.1	68.0	58.0	44.7	34.5
14.0	65.3	62.7	59.9	58.0	44.4	34.2
16.0	57.2	55.5	53.7	51.5	44.0	33.7
18.0	47.7	49.1	48.0	46.7	43.7	33.4
20.0	40.5	41.8	42.6	42.5	41.2	33.0
22.0	34.8	36.0	36.8	37.8	37.7	32.7
24.0	30.2	31.4	32.2	33.1	33.9	32.4
26.0	26.2	27.5	28.3	29.3	30.1	30.1
28.0	22.9	24.1	25.0	26.0	26.8	26.9
30.0	20.1	21.3	22.1	23.1	24.0	24.1
32.0	17.7	18.8	19.7	20.7	21.5	21.6
34.0		16.7	17.5	18.5	19.3	19.4
36.0		14.8	15.6	16.6	17.5	17.5
38.0		13.2	14.0	15.0	15.8	15.9
40.0			12.6	13.5	14.3	14.4
42.0			11.3	12.2	13.0	13.1
44.0				11.0	11.8	11.9
46.0				10.0	10.7	10.8
48.0				9.0	9.7	9.8
50.0					8.8	8.9
52.0					8.0	8.1
54.0						7.4
56.0						6.7
58.0						4.7

MB + PS

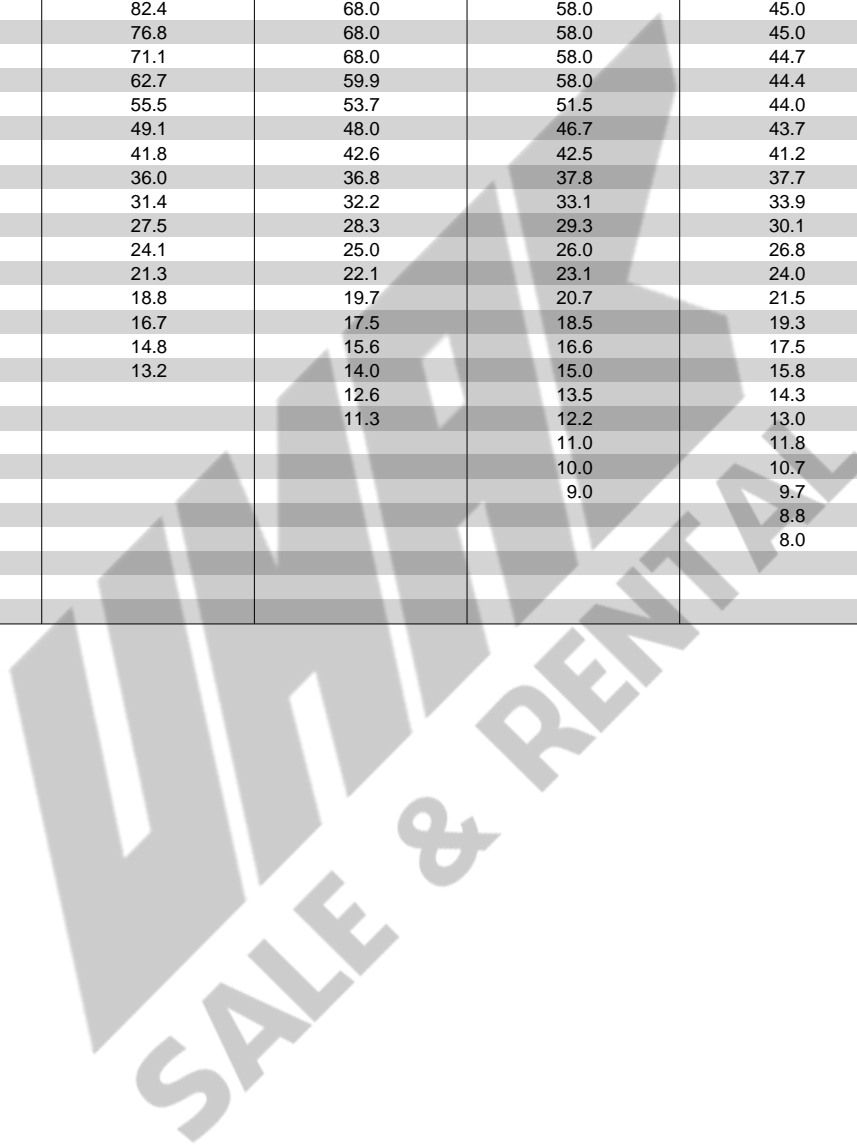

Hubhöhen
Lifting heights
Hauteurs de levage
Alturas de elevación

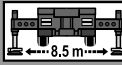
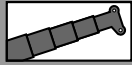

138t

DIN/ISO/EN

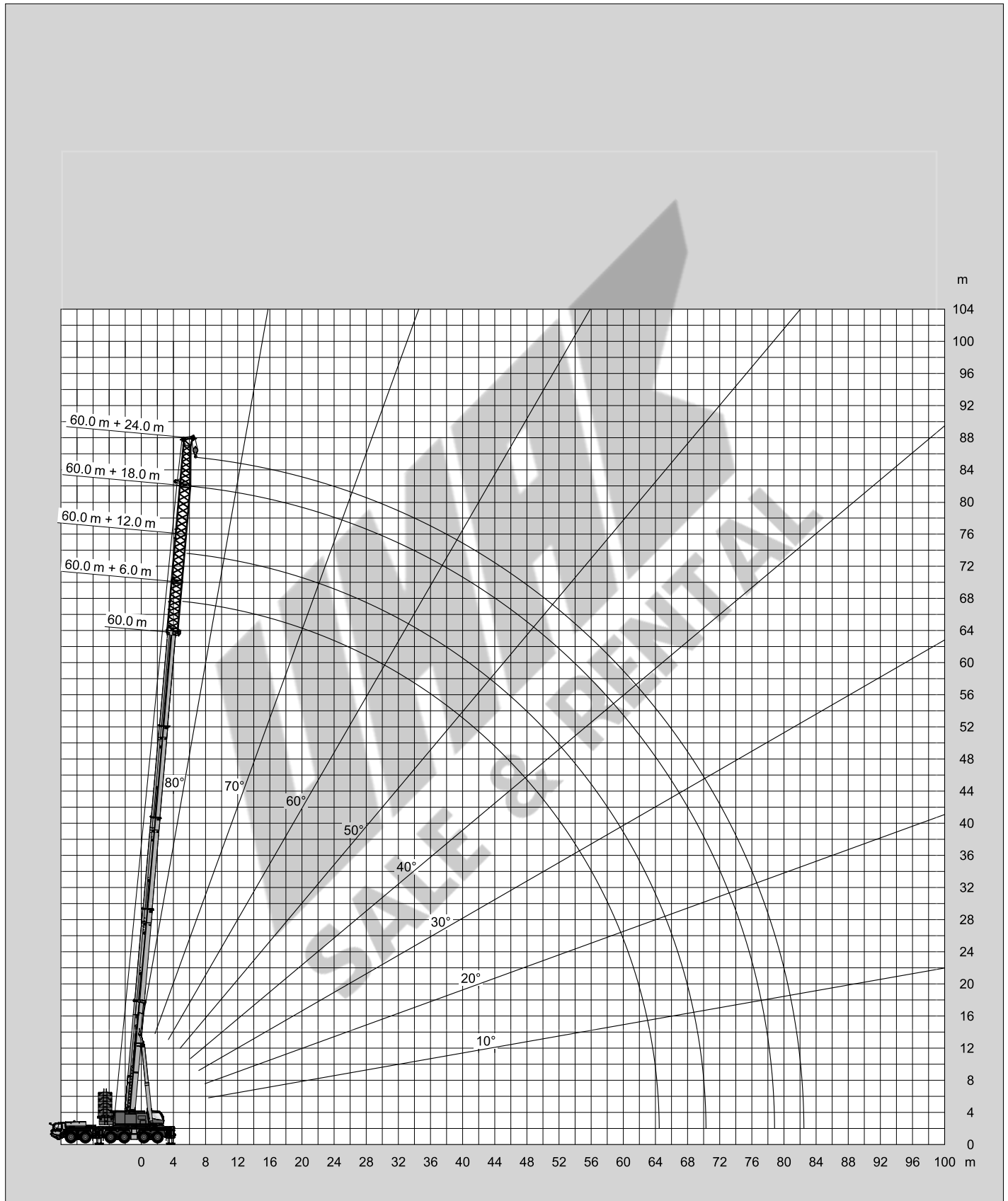

Tragfähigkeiten
Lifting capacities
Capacités de levage
Capacidades de elevación

138t

DIN/ISO/EN

--> m	LFJ 6.0 m					LFJ 12.0 m					LFJ 18.0 m					LFJ 24.0 m				
	40.4 m	45.4 m	50.5 m	55.6 m	60.0 m	40.4 m	45.4 m	50.5 m	55.6 m	60.0 m	40.4 m	45.4 m	50.5 m	55.6 m	60.0 m	40.4 m	45.4 m	50.5 m	55.6 m	60.0 m
7.0	54.2																			
8.0	50.7	43.2																		
9.0	47.6	40.8	32.2			43.5														
10.0	44.9	38.6	30.5	26.8		41.0	34.9				34.3					25.5				
11.0	42.5	36.8	29.0	25.5	24.2	38.8	33.1	26.1			32.8					24.6				
12.0	40.4	35.1	27.6	24.2	23.0	36.8	31.5	24.8	22.1		31.4	28.7				23.8	22.6			
14.0	36.8	32.2	25.2	22.1	21.0	33.4	28.8	22.6	20.3	19.1	29.0	26.2	20.9	18.2		22.2	21.4	18.8		
16.0	33.8	29.7	23.3	20.4	19.3	30.6	26.5	20.8	18.7	17.6	26.9	24.1	19.2	16.8	16.0	20.8	20.2	17.3	15.2	
18.0	31.3	27.5	21.7	18.9	18.0	28.2	24.6	19.3	17.3	16.3	25.0	22.3	17.8	15.7	14.9	19.5	19.1	16.1	14.1	13.4
20.0	29.2	25.5	20.3	17.7	16.8	26.2	23.0	18.0	16.1	15.2	23.4	20.8	16.5	14.6	13.9	18.2	18.1	15.0	13.1	12.5
22.0	27.4	23.9	19.1	16.6	15.7	24.5	21.6	16.8	15.0	14.2	22.0	19.5	15.4	13.7	13.1	17.1	17.0	14.1	12.3	11.7
24.0	25.8	22.4	18.0	15.6	14.8	23.0	20.4	15.9	14.1	13.3	20.7	18.3	14.5	12.9	12.3	16.1	16.1	13.2	11.6	11.0
26.0	24.4	21.2	17.1	14.8	14.0	21.7	19.3	15.0	13.3	12.6	19.6	17.3	13.6	12.2	11.5	15.2	15.3	12.4	10.9	10.4
28.0	22.9	20.0	16.2	14.0	13.3	20.5	18.2	14.2	12.6	11.9	18.6	16.4	12.9	11.5	10.9	14.4	14.5	11.7	10.3	9.9
30.0	21.5	19.0	15.5	13.4	12.6	19.5	17.3	13.5	12.0	11.3	17.6	15.6	12.2	10.9	10.3	13.6	13.8	11.0	9.8	9.4
32.0	20.3	18.2	14.8	12.8	12.1	18.6	16.4	12.9	11.4	10.7	16.8	14.8	11.6	10.3	9.8	13.0	13.2	10.5	9.3	8.9
34.0	19.2	17.3	14.3	12.2	11.5	17.7	15.6	12.3	10.9	10.2	16.1	14.2	11.1	9.8	9.3	12.3	12.6	9.9	8.9	8.4
36.0	18.2	16.6	13.7	11.7	11.1	17.0	14.9	11.8	10.4	9.8	15.4	13.6	10.6	9.4	8.9	11.8	12.0	9.5	8.4	8.0
38.0	17.3	16.0	13.2	11.3	10.6	16.3	14.3	11.3	9.9	9.4	14.7	13.0	10.1	8.9	8.5	11.3	11.5	9.0	8.0	7.6
40.0	16.5	15.4	12.8	10.9	10.2	15.7	13.7	10.9	9.5	9.0	14.1	12.5	9.7	8.6	8.1	10.8	11.1	8.6	7.7	7.3
44.0	12.9	14.1	12.1	10.2	9.5	14.3	12.7	10.2	8.8	8.3	13.1	11.5	9.0	7.9	7.5	10.0	10.3	7.9	7.0	6.6
48.0		13.1	11.5	9.6	9.0	13.2	11.9	9.6	8.3	7.7	12.2	10.7	8.4	7.3	6.9	9.3	9.6	7.3	6.5	6.0
52.0			11.2	9.1	8.5		11.3	9.1	7.8	7.3	11.5	10.0	7.9	6.8	6.3	8.7	9.0	6.8	6.0	5.3
56.0				8.8	7.8			8.7	7.4	6.6	8.2	9.4	7.4	6.4	5.7	8.2	8.4	6.4	5.6	4.7
60.0				4.3	6.9			7.4	7.0	6.0		8.8	7.1	6.0	5.1	7.8	8.0	6.0	5.2	4.2
64.0									6.9	5.5			6.9	5.8	4.6		7.5	5.7	4.8	3.7
68.0										5.0				5.5	4.2			5.5	4.5	3.3
72.0															3.8			4.5	4.2	3.0
76.0																			4.0	2.6
80.0																				2.4

MB+LFJ

SALE & RENTAL

Tragfähigkeiten
Lifting capacities
Capacités de levage
Capacidades de elevación

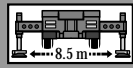
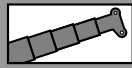

118t

DIN/ISO/EN

m	LFJ 6.0 m					LFJ 12.0 m					LFJ 18.0 m					LFJ 24.0 m						
	40.4 m	45.4 m	50.5 m	55.6 m	60.0 m	40.4 m	45.4 m	50.5 m	55.6 m	60.0 m	40.4 m	45.4 m	50.5 m	55.6 m	60.0 m	40.4 m	45.4 m	50.5 m	55.6 m	60.0 m		
7.0	54.2																					
8.0	50.7	43.2																				
9.0	47.6	40.8	32.2			43.5																
10.0	44.9	38.6	30.5	26.8		41.0	34.9				34.3					25.5						
11.0	42.5	36.8	29.0	25.5	24.2	38.8	33.1	26.1			32.8					24.6						
12.0	40.4	35.1	27.6	24.2	23.0	36.8	31.5	24.8	22.1		31.4	28.7				23.8	22.6					
14.0	36.8	32.2	25.2	22.1	21.0	33.4	28.8	22.6	20.3	19.1	29.0	26.2	20.9	18.2		22.2	21.4	18.8				
16.0	33.8	29.7	23.3	20.4	19.3	30.6	26.5	20.8	18.7	17.6	26.9	24.1	19.2	16.8	16.0	20.8	20.2	17.3	15.2			
18.0	31.3	27.5	21.7	18.9	18.0	28.2	24.6	19.3	17.3	16.3	25.0	22.3	17.8	15.7	14.9	19.5	19.1	16.1	14.1	13.4		
20.0	29.2	25.5	20.3	17.7	16.8	26.2	23.0	18.0	16.1	15.2	23.4	20.8	16.5	14.6	13.9	18.2	18.1	15.0	13.1	12.5		
22.0	27.4	23.9	19.1	16.6	15.7	24.5	21.6	16.8	15.0	14.2	22.0	19.5	15.4	13.7	13.1	17.1	17.0	14.1	12.3	11.7		
24.0	25.8	22.4	18.0	15.6	14.8	23.0	20.4	15.9	14.1	13.3	20.7	18.3	14.5	12.9	12.3	16.1	16.1	13.2	11.6	11.0		
26.0	24.4	21.2	17.1	14.8	14.0	21.7	19.3	15.0	13.3	12.6	19.6	17.3	13.6	12.2	11.5	15.2	15.3	12.4	10.9	10.4		
28.0	22.9	20.0	16.2	14.0	13.3	20.5	18.2	14.2	12.6	11.9	18.6	16.4	12.9	11.5	10.9	14.4	14.5	11.7	10.3	9.9		
30.0	21.5	19.0	15.5	13.4	12.6	19.5	17.3	13.5	12.0	11.3	17.6	15.6	12.2	10.9	10.3	13.6	13.8	11.0	9.8	9.4		
32.0	20.3	18.2	14.8	12.8	12.1	18.6	16.4	12.9	11.4	10.7	16.8	14.8	11.6	10.3	9.8	13.0	13.2	10.5	9.3	8.9		
34.0	19.2	17.3	14.3	12.2	11.5	17.7	15.6	12.3	10.9	10.2	16.1	14.2	11.1	9.8	9.3	12.3	12.6	9.9	8.9	8.4		
36.0	18.2	16.6	13.7	11.7	11.1	17.0	14.9	11.8	10.4	9.8	15.4	13.6	10.6	9.4	8.9	11.8	12.0	9.5	8.4	8.0		
38.0	17.3	16.0	13.2	11.3	10.6	16.3	14.3	11.3	9.9	9.4	14.7	13.0	10.1	8.9	8.5	11.3	11.5	9.0	8.0	7.6		
40.0	16.5	15.4	12.8	10.9	10.2	15.7	13.7	10.9	9.5	9.0	14.1	12.5	9.7	8.6	8.1	10.8	11.1	8.6	7.7	7.3		
44.0	12.9	14.1	12.1	10.2	9.5	14.3	12.7	10.2	8.8	8.3	13.1	11.5	9.0	7.9	7.5	10.0	10.3	7.9	7.0	6.6		
48.0		12.7	11.5	9.6	9.0	12.9	11.9	9.6	8.3	7.7	12.2	10.7	8.4	7.3	6.9	9.3	9.6	7.3	6.5	6.0		
52.0			11.2	9.1	8.5		11.2	9.1	7.8	7.3	11.5	10.0	7.9	6.8	6.3	8.7	9.0	6.8	6.0	5.3		
56.0				8.8	7.8			8.7	7.4	6.6	8.2	9.4	7.4	6.4	5.7	8.2	8.4	6.4	5.6	4.7		
60.0				4.3	6.9			7.4	7.0	6.0		8.6	7.1	6.0	5.1	7.8	8.0	6.0	5.2	4.2		
64.0									6.9	5.5				6.9	5.8	4.6		7.5	5.7	4.8	3.7	
68.0										5.0					5.5	4.2			5.5	4.5	3.3	
72.0															3.8				4.5	4.2	3.0	
76.0																			4.0	4.0	2.6	
80.0																					2.4	



Tragfähigkeiten
Lifting capacities
Capacités de levage
Capacidades de elevación







DIN/ISO/EN

m	LFJ 6.0 m					LFJ 12.0 m					LFJ 18.0 m					LFJ 24.0 m					
	40.4 m	45.4 m	50.5 m	55.6 m	60.0 m	40.4 m	45.4 m	50.5 m	55.6 m	60.0 m	40.4 m	45.4 m	50.5 m	55.6 m	60.0 m	40.4 m	45.4 m	50.5 m	55.6 m	60.0 m	
7.0	54.2																				
8.0	50.7	43.2																			
9.0	47.6	40.8	32.2			43.5															
10.0	44.9	38.6	30.5	26.8		41.0	34.9				34.3				25.5						
11.0	42.5	36.8	29.0	25.5	24.2	38.8	33.1	26.1			32.8				24.6						
12.0	40.4	35.1	27.6	24.2	23.0	36.8	31.5	24.8	22.1		31.4	28.7			23.8	22.6					
14.0	36.8	32.2	25.2	22.1	21.0	33.4	28.8	22.6	20.3	19.1	29.0	26.2	20.9	18.2	22.2	21.4	18.8				
16.0	33.8	29.7	23.3	20.4	19.3	30.6	26.5	20.8	18.7	17.6	26.9	24.1	19.2	16.8	16.0	20.8	20.2	17.3	15.2		
18.0	31.3	27.5	21.7	18.9	18.0	28.2	24.6	19.3	17.3	16.3	25.0	22.3	17.8	15.7	14.9	19.5	19.1	16.1	14.1	13.4	
20.0	29.2	25.5	20.3	17.7	16.8	26.2	23.0	18.0	16.1	15.2	23.4	20.8	16.5	14.6	13.9	18.2	18.1	15.0	13.1	12.5	
22.0	27.4	23.9	19.1	16.6	15.7	24.5	21.6	16.8	15.0	14.2	22.0	19.5	15.4	13.7	13.1	17.1	17.0	14.1	12.3	11.7	
24.0	25.8	22.4	18.0	15.6	14.8	23.0	20.4	15.9	14.1	13.3	20.7	18.3	14.5	12.9	12.3	16.1	16.1	13.2	11.6	11.0	
26.0	23.0	21.2	17.1	14.8	14.0	21.7	19.3	15.0	13.3	12.6	19.6	17.3	13.6	12.2	11.5	15.2	15.3	12.4	10.9	10.4	
28.0	20.2	20.0	16.2	14.0	13.3	20.5	18.2	14.2	12.6	11.9	18.6	16.4	12.9	11.5	10.9	14.4	14.5	11.7	10.3	9.9	
30.0	17.9	18.3	15.5	13.4	12.6	18.5	17.3	13.5	12.0	11.3	17.6	15.6	12.2	10.9	10.3	13.6	13.8	11.0	9.8	9.4	
32.0	15.9	16.3	14.8	12.8	12.1	16.5	16.4	12.9	11.4	10.7	16.8	14.8	11.6	10.3	9.8	13.0	13.2	10.5	9.3	8.9	
34.0	14.2	14.5	14.3	12.2	11.5	14.7	15.0	12.3	10.9	10.2	15.3	14.2	11.1	9.8	9.3	12.3	12.6	9.9	8.9	8.4	
36.0	12.7	13.0	13.6	11.7	11.1	13.2	13.5	11.8	10.4	9.8	13.8	13.6	10.6	9.4	8.9	11.8	12.0	9.5	8.4	8.0	
38.0	11.3	11.7	12.3	11.3	10.6	11.8	12.1	11.3	9.9	9.4	12.4	12.5	10.1	8.9	8.5	11.3	11.5	9.0	8.0	7.6	
40.0	10.1	10.5	11.1	10.9	10.2	10.6	10.9	10.9	9.5	9.0	11.2	11.3	9.7	8.6	8.1	10.8	11.1	8.6	7.7	7.3	
44.0	8.2	8.4	9.0	9.4	9.5	8.6	8.8	9.2	8.8	8.3	9.1	9.2	9.0	7.9	7.5	9.4	9.4	7.9	7.0	6.6	
48.0		6.8	7.3	7.7	7.8	7.0	7.1	7.5	7.9	7.7	7.4	7.5	7.8	7.3	6.9	7.7	7.6	7.3	6.5	6.0	
52.0			6.0	6.4	6.4		5.8	6.1	6.5	6.4	6.1	6.1	6.4	6.7	6.3	6.2	6.2	6.4	6.0	5.3	
56.0				5.2	5.2			4.9	5.3	5.2	4.9	4.9	5.2	5.5	5.3	5.1	5.0	5.2	5.4	4.7	
60.0				4.3	4.2			4.0	4.3	4.2		4.0	4.2	4.4	4.3	4.1	4.0	4.2	4.3	4.1	
64.0									3.4	3.3			3.4	3.6	3.4		3.1	3.3	3.4	3.3	
68.0										2.6				2.8	2.6			2.6	2.7	2.5	
72.0															2.0			1.9	2.0	1.8	
76.0																			1.5		
80.0																					

MB+LFJ

SALE & RENTAL

Tragfähigkeiten
Lifting capacities
Capacités de levage
Capacidades de elevación

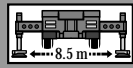
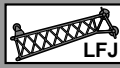
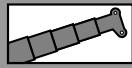

58t

DIN/ISO/EN

m	LFJ 6.0 m					LFJ 12.0 m					LFJ 18.0 m					LFJ 24.0 m					
	40.4 m	45.4 m	50.5 m	55.6 m	60.0 m	40.4 m	45.4 m	50.5 m	55.6 m	60.0 m	40.4 m	45.4 m	50.5 m	55.6 m	60.0 m	40.4 m	45.4 m	50.5 m	55.6 m	60.0 m	
7.0	54.2																				
8.0	50.7	43.2																			
9.0	47.6	40.8	32.2			43.5															
10.0	44.9	38.6	30.5	26.8		41.0	34.9				34.3					25.5					
11.0	42.5	36.8	29.0	25.5	24.2	38.8	33.1	26.1			32.8					24.6					
12.0	40.4	35.1	27.6	24.2	23.0	36.8	31.5	24.8	22.1		31.4	28.7				23.8	22.6				
14.0	36.8	32.2	25.2	22.1	21.0	33.4	28.8	22.6	20.3	19.1	29.0	26.2	20.9	18.2		22.2	21.4	18.8			
16.0	33.8	29.7	23.3	20.4	19.3	30.6	26.5	20.8	18.7	17.6	26.9	24.1	19.2	16.8	16.0	20.8	20.2	17.3	15.2		
18.0	31.3	27.5	21.7	18.9	18.0	28.2	24.6	19.3	17.3	16.3	25.0	22.3	17.8	15.7	14.9	19.5	19.1	16.1	14.1	13.4	
20.0	27.1	25.5	20.3	17.7	16.8	26.2	23.0	18.0	16.1	15.2	23.4	20.8	16.5	14.6	13.9	18.2	18.1	15.0	13.1	12.5	
22.0	23.1	23.3	19.1	16.6	15.7	23.5	21.6	16.8	15.0	14.2	22.0	19.5	15.4	13.7	13.1	17.1	17.0	14.1	12.3	11.7	
24.0	19.7	20.2	18.0	15.6	14.8	20.4	20.4	15.9	14.1	13.3	20.7	18.3	14.5	12.9	12.3	16.1	16.1	13.2	11.6	11.0	
26.0	16.9	17.4	17.1	14.8	14.0	17.6	17.9	15.0	13.3	12.6	18.3	17.3	13.6	12.2	11.5	15.2	15.3	12.4	10.9	10.4	
28.0	14.6	15.0	15.7	14.0	13.3	15.3	15.6	14.2	12.6	11.9	15.9	16.0	12.9	11.5	10.9	14.4	14.5	11.7	10.3	9.9	
30.0	12.6	13.1	13.7	13.4	12.6	13.3	13.6	13.5	12.0	11.3	13.9	14.0	12.2	10.9	10.3	13.6	13.8	11.0	9.8	9.4	
32.0	11.0	11.4	12.0	12.5	12.1	11.6	11.9	12.3	11.4	10.7	12.2	12.3	11.6	10.3	9.8	12.6	12.6	10.5	9.3	8.9	
34.0	9.5	9.9	10.6	11.0	11.1	10.1	10.4	10.8	10.9	10.2	10.7	10.8	11.1	9.8	9.3	11.1	11.1	9.9	8.9	8.4	
36.0	8.3	8.7	9.3	9.8	9.8	8.9	9.1	9.5	10.0	9.8	9.5	9.5	10.0	9.4	8.9	9.8	9.8	9.5	8.4	8.0	
38.0	7.2	7.6	8.2	8.6	8.7	7.7	8.0	8.4	8.9	8.7	8.3	8.4	8.8	8.9	8.5	8.6	8.6	8.6	8.8	8.0	7.6
40.0	6.3	6.6	7.2	7.6	7.7	6.8	7.0	7.4	7.8	7.7	7.3	7.4	7.8	8.0	7.9	7.6	7.6	7.8	7.7	7.3	
44.0	4.7	4.9	5.5	5.9	6.0	5.1	5.3	5.7	6.1	6.0	5.6	5.7	6.1	6.3	6.2	5.9	5.9	6.1	6.2	6.1	
48.0		3.7	4.2	4.6	4.6	3.8	4.0	4.3	4.7	4.6	4.3	4.3	4.7	4.9	4.8	4.5	4.5	4.7	4.8	4.6	
52.0			3.1	3.5	3.5		2.9	3.2	3.6	3.5	3.1	3.2	3.5	3.7	3.6	3.3	3.3	3.5	3.7	3.5	
56.0				2.5	2.5			2.3	2.6	2.5	2.3	2.2	2.5	2.8	2.6	2.4	2.3	2.5	2.7	2.5	
60.0				1.8	1.7			1.5	1.8	1.7		1.5	1.7	1.9	1.8	1.6	1.5	1.7	1.8	1.7	
64.0																					
68.0																					
72.0																					
76.0																					
80.0																					

SALE & RENTAL



UNIVERSAL
SALE & RENTAL

Hubhöhen
Lifting heights
Hauteurs de levage
Alturas de elevación

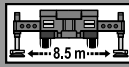
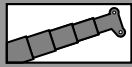

138t

DIN/ISO/EN

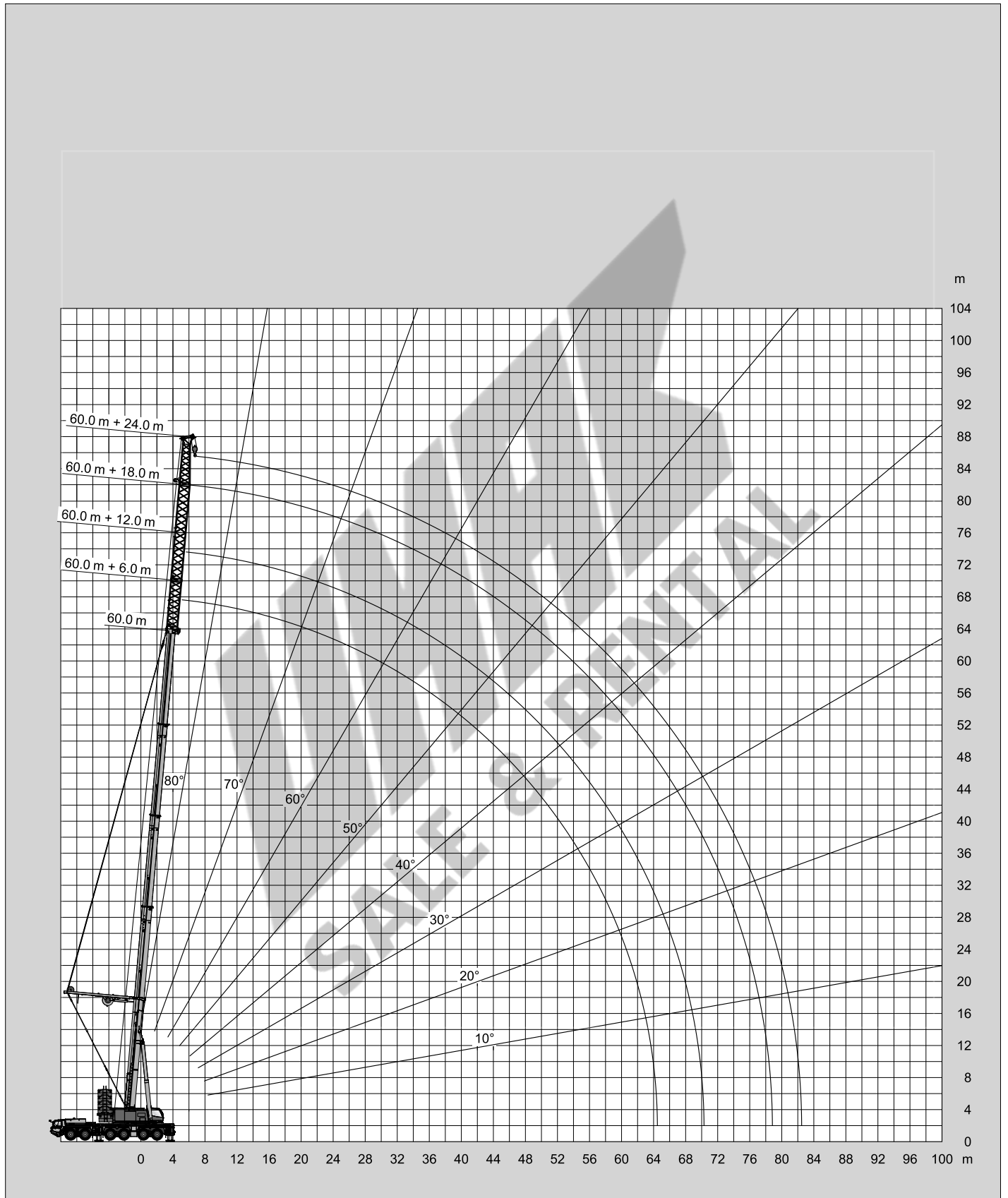

Tragfähigkeiten
Lifting capacities
Capacités de levage
Capacidades de elevación



m	LFJ 6.0 m					LFJ 12.0 m					LFJ 18.0 m					LFJ 24.0 m				
	40.4 m	45.4 m	50.5 m	55.6 m	60.0 m	40.4 m	45.4 m	50.5 m	55.6 m	60.0 m	40.4 m	45.4 m	50.5 m	55.6 m	60.0 m	40.4 m	45.4 m	50.5 m	55.6 m	60.0 m
7.0	58.6																			
8.0	58.6	51.1																		
9.0	58.6	51.1	39.9			47.4														
10.0	58.6	51.1	38.3	31.8		47.4	38.4				33.3					23.7				
11.0	58.6	51.1	36.8	30.6	28.1	47.4	38.4	31.2			33.3					23.7				
12.0	58.6	51.1	35.5	29.4	28.0	47.4	38.4	29.9	23.9		33.2	29.1				23.7	20.9			
14.0	58.5	50.5	33.2	27.3	26.1	45.2	38.4	27.7	23.9	20.9	31.1	29.1	22.8	17.9		23.0	20.9	16.8		
16.0	51.7	48.3	31.1	25.6	24.4	42.7	38.4	25.8	22.3	20.9	29.1	28.5	22.6	17.9	15.8	21.6	20.9	16.8	13.2	
18.0	46.1	44.1	29.4	24.0	23.0	40.4	38.3	24.2	20.8	19.9	27.3	27.0	21.0	17.9	15.4	20.4	19.9	16.8	13.2	11.2
20.0	41.6	39.8	27.9	22.7	21.8	37.1	35.7	22.8	19.5	18.7	25.5	25.7	19.7	17.2	15.0	19.2	19.0	16.8	13.2	10.9
22.0	37.7	36.1	26.5	21.5	20.6	33.7	32.4	21.5	18.4	17.7	23.9	24.4	18.5	16.1	14.6	18.1	18.0	16.1	13.2	10.6
24.0	34.5	33.0	25.3	20.4	19.6	30.8	29.6	20.4	17.4	16.7	22.5	23.1	17.5	15.2	14.1	17.2	17.2	15.2	13.2	10.2
26.0	31.7	30.3	24.2	19.5	18.7	28.3	27.2	19.4	16.5	15.9	21.2	21.9	16.6	14.4	13.7	16.3	16.4	14.3	12.6	9.8
28.0	29.3	27.9	23.3	18.6	17.9	26.2	25.1	18.5	15.7	15.1	20.0	20.8	15.7	13.6	13.2	15.4	15.7	13.6	11.9	9.4
30.0	27.1	25.9	22.4	17.8	16.7	24.2	23.2	17.7	15.0	14.4	19.0	19.8	15.0	12.9	12.6	14.6	15.0	12.9	11.3	9.0
32.0	24.4	24.1	21.6	17.2	15.6	22.5	21.6	17.0	14.3	13.4	18.0	18.8	14.3	12.3	11.9	13.9	14.3	12.3	10.8	8.7
34.0	22.0	22.5	20.9	16.5	14.6	21.0	20.1	16.3	13.7	12.5	17.2	18.0	13.7	11.8	11.1	13.2	13.7	11.7	10.2	8.3
36.0	19.9	20.4	20.3	15.9	13.7	19.7	18.8	15.7	13.2	11.7	16.4	17.2	13.1	11.3	10.3	12.6	13.1	11.2	9.8	7.9
38.0	18.0	18.5	19.3	15.4	12.8	18.5	17.6	15.2	12.7	10.9	15.7	16.1	12.6	10.8	9.6	12.0	12.5	10.7	9.3	7.5
40.0	16.3	16.9	17.6	14.9	12.1	17.1	16.6	14.7	12.2	10.3	15.0	15.1	12.2	10.4	9.0	11.5	12.0	10.3	8.9	7.1
44.0	11.0	14.0	14.7	14.1	10.8	14.3	14.6	13.8	11.4	9.1	13.9	13.4	11.3	9.6	8.0	10.5	11.1	9.5	8.2	6.5
48.0		11.7	12.4	12.9	9.7	11.9	12.3	12.7	10.7	8.2	12.6	12.0	10.6	9.0	7.1	9.7	10.3	8.9	7.6	5.8
52.0			10.4	10.9	8.8		10.3	10.8	10.1	7.3	10.7	10.7	10.0	8.4	6.3	9.0	9.6	8.3	7.1	5.2
56.0				9.3	7.8			9.1	9.6	6.6	8.8	9.2	9.5	7.9	5.7	8.5	8.7	7.8	6.7	4.7
60.0				2.7	6.9			5.9	8.1	6.0		7.6	8.1	7.5	5.1	8.0	7.8	7.4	6.3	4.2
64.0									6.8	5.5			6.9	7.2	4.6		6.8	6.8	5.9	3.7
68.0										5.0				6.1	4.2			5.9	5.6	3.3
72.0															3.8			3.2	5.2	3.0
76.0																			4.0	2.6
80.0																				2.4

MB + LFJ + PS

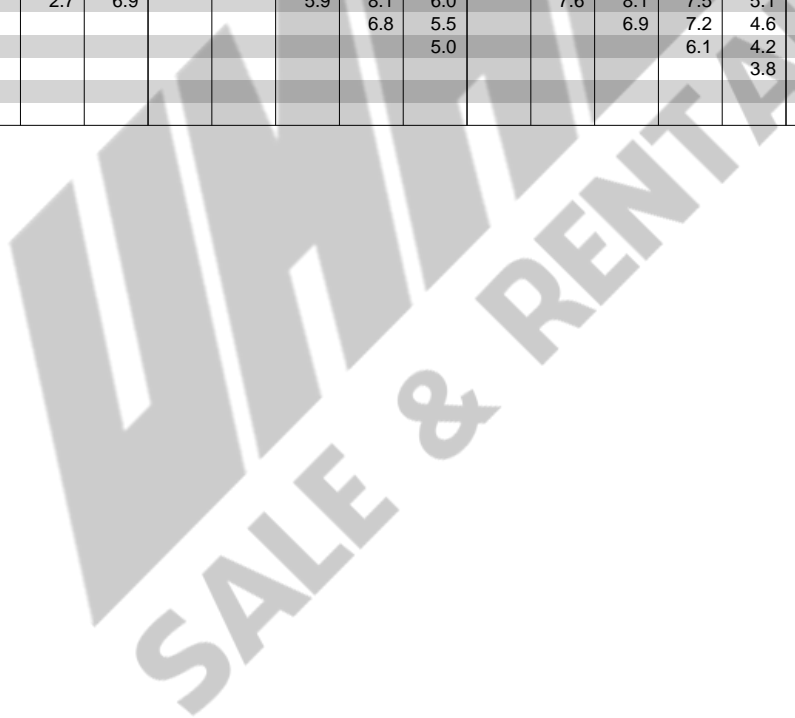

Tragfähigkeiten
Lifting capacities
Capacités de levage
Capacidades de elevación



m	LFJ 6.0 m					LFJ 12.0 m					LFJ 18.0 m					LFJ 24.0 m				
	40.4 m	45.4 m	50.5 m	55.6 m	60.0 m	40.4 m	45.4 m	50.5 m	55.6 m	60.0 m	40.4 m	45.4 m	50.5 m	55.6 m	60.0 m	40.4 m	45.4 m	50.5 m	55.6 m	60.0 m
7.0	58.6																			
8.0	58.6	51.1																		
9.0	58.6	51.1	39.9			47.4														
10.0	58.6	51.1	38.3	31.8		47.4					33.3					23.7				
11.0	58.6	51.1	36.8	30.6	28.1	47.4					33.3					23.7				
12.0	58.6	51.1	35.5	29.4	28.0	47.4	38.4		23.9		33.2					23.7				
14.0	58.5	50.5	33.2	27.3	26.1	45.2	38.4		23.9	20.9	31.1			17.9		23.0				
16.0	51.7	48.3	31.1	25.6	24.4	42.7	38.4	25.8	22.3	20.9	29.1	28.5		17.9	15.8	21.6			13.2	
18.0	46.1	44.1	29.4	24.0	23.0	40.4	38.3	24.2	20.8	19.9	27.3	27.0		17.9	15.4	20.4	19.9		13.2	
20.0	41.6	39.8	27.9	22.7	21.8	37.1	35.7	22.8	19.5	18.7	25.5	25.7	19.7	17.2	15.0	19.2	19.0		13.2	10.9
22.0	37.7	36.1	26.5	21.5	20.6	33.7	32.4	21.5	18.4	17.7	23.9	24.4	18.5	16.1	14.6	18.1	18.0		13.2	10.6
24.0	34.5	33.0	25.3	20.4	19.6	30.8	29.6	20.4	17.4	16.7	22.5	23.1	17.5	15.2	14.1	17.2	17.2		13.2	10.2
26.0	31.7	30.3	24.2	19.5	18.7	28.3	27.2	19.4	16.5	15.9	21.2	21.9	16.6	14.4	13.7	16.3	16.4	14.3	12.6	9.8
28.0	29.3	27.9	23.3	18.6	17.9	26.2	25.1	18.5	15.7	15.1	20.0	20.8	15.7	13.6	13.2	15.4	15.7	13.6	11.9	9.4
30.0	27.1	25.9	22.4	17.8	16.7	24.2	23.2	17.7	15.0	14.4	19.0	19.8	15.0	12.9	12.6	14.6	15.0	12.9	11.3	9.0
32.0	25.2	24.1	21.6	17.2	15.6	22.5	21.6	17.0	14.3	13.4	18.0	18.8	14.3	12.3	11.9	13.9	14.3	12.3	10.8	8.7
34.0	23.5	22.5	20.9	16.5	14.6	21.0	20.1	16.3	13.7	12.5	17.2	18.0	13.7	11.8	11.1	13.2	13.7	11.7	10.2	8.3
36.0	21.5	21.0	20.3	15.9	13.7	19.7	18.8	15.7	13.2	11.7	16.4	17.2	13.1	11.3	10.3	12.6	13.1	11.2	9.8	7.9
38.0	19.6	19.7	19.3	15.4	12.8	18.5	17.6	15.2	12.7	10.9	15.7	16.1	12.6	10.8	9.6	12.0	12.5	10.7	9.3	7.5
40.0	17.9	18.0	17.9	14.9	12.1	17.4	16.6	14.7	12.2	10.3	15.0	15.1	12.2	10.4	9.0	11.5	12.0	10.3	8.9	7.1
44.0				14.1	10.8	15.4	14.7	13.8	11.4	9.1	13.9	13.4	11.3	9.6	8.0	10.5	11.1	9.5	8.2	6.5
48.0				13.0	9.7	13.5	13.1	12.8	10.7	8.2	12.6	12.0	10.6	9.0	7.1	9.7	10.3	8.9	7.6	5.8
52.0									10.1	7.3	11.4	10.7	10.0	8.4	6.3	9.0	9.6	8.3	7.1	5.2
56.0									9.6	6.6	6.8	9.7		7.9	5.7	8.5	8.7	7.8	6.7	4.7
60.0														7.5	5.1	8.0	7.8	7.4	6.3	4.2
64.0																			5.9	3.7
68.0																				
72.0																				
76.0																				
80.0																				



Tragfähigkeiten
Lifting capacities
Capacités de levage
Capacidades de elevación



m	LFJ 6.0 m					LFJ 12.0 m					LFJ 18.0 m					LFJ 24.0 m				
	40.4 m	45.4 m	50.5 m	55.6 m	60.0 m	40.4 m	45.4 m	50.5 m	55.6 m	60.0 m	40.4 m	45.4 m	50.5 m	55.6 m	60.0 m	40.4 m	45.4 m	50.5 m	55.6 m	60.0 m
7.0	58.6																			
8.0	58.6	51.1																		
9.0	58.6	51.1	39.9			47.4														
10.0	58.6	51.1	38.3	31.8		47.4	38.4				33.3					23.7				
11.0	58.6	51.1	36.8	30.6	28.1	47.4	38.4	31.2			33.3					23.7				
12.0	58.6	51.1	35.5	29.4	28.0	47.4	38.4	29.9	23.9		33.2	29.1				23.7	20.9			
14.0	56.7	50.5	33.2	27.3	26.1	45.2	38.4	27.7	23.9	20.9	31.1	29.1	22.8	17.9		23.0	20.9	16.8		
16.0	47.9	47.1	31.1	25.6	24.4	42.7	38.4	25.8	22.3	20.9	29.1	28.5	22.6	17.9	15.8	21.6	20.9	16.8	13.2	
18.0	41.1	40.5	29.4	24.0	23.0	40.4	38.3	24.2	20.8	19.9	27.3	27.0	21.0	17.9	15.4	20.4	19.9	16.8	13.2	11.2
20.0	35.6	35.3	27.9	22.7	21.8	35.5	35.0	22.8	19.5	18.7	25.5	25.7	19.7	17.2	15.0	19.2	19.0	16.8	13.2	10.9
22.0	30.6	30.9	26.5	21.5	20.6	31.2	30.8	21.5	18.4	17.7	23.9	24.4	18.5	16.1	14.6	18.1	18.0	16.1	13.2	10.6
24.0	26.3	26.9	25.3	20.4	19.6	27.3	27.3	20.4	17.4	16.7	22.5	23.1	17.5	15.2	14.1	17.2	17.2	15.2	13.2	10.2
26.0	22.8	23.4	24.2	19.5	18.7	23.8	24.2	19.4	16.5	15.9	21.2	21.9	16.6	14.4	13.7	16.3	16.4	14.3	12.6	9.8
28.0	19.9	20.5	21.3	18.6	17.9	20.8	21.2	18.5	15.7	15.1	20.0	20.8	15.7	13.6	13.2	15.4	15.7	13.6	11.9	9.4
30.0	17.4	18.0	18.8	17.8	16.7	18.3	18.7	17.7	15.0	14.4	19.0	19.3	15.0	12.9	12.6	14.6	15.0	12.9	11.3	9.0
32.0	15.3	15.9	16.7	17.2	15.6	16.2	16.6	17.0	14.3	13.4	17.0	17.2	14.3	12.3	11.9	13.9	14.3	12.3	10.8	8.7
34.0	13.5	14.0	14.8	15.3	14.6	14.3	14.7	15.2	13.7	12.5	15.1	15.3	13.7	11.8	11.1	13.2	13.7	11.7	10.2	8.3
36.0	11.9	12.4	13.2	13.7	13.7	12.7	13.1	13.6	13.2	11.7	13.5	13.7	13.1	11.3	10.3	12.6	13.1	11.2	9.8	7.9
38.0	10.5	11.0	11.7	12.3	12.4	11.3	11.6	12.1	12.6	10.9	12.1	12.2	12.6	10.8	9.6	12.0	12.5	10.7	9.3	7.5
40.0	9.2	9.7	10.5	11.0	11.1	10.0	10.4	10.8	11.4	10.3	10.8	10.9	11.4	10.4	9.0	11.2	11.3	10.3	8.9	7.1
44.0	7.1	7.6	8.3	8.8	8.9	7.8	8.2	8.7	9.2	9.1	8.6	8.7	9.2	9.5	8.0	9.0	9.1	9.3	8.2	6.5
48.0		5.8	6.5	7.0	7.1	6.1	6.4	6.9	7.4	7.3	6.8	6.9	7.4	7.7	7.1	7.2	7.3	7.5	7.6	5.8
52.0			5.0	5.5	5.6		4.9	5.4	5.9	5.8	5.3	5.5	5.9	6.2	6.1	5.7	5.8	6.0	6.2	5.2
56.0				4.3	4.3			4.1	4.6	4.5	4.1	4.2	4.6	4.9	4.8	4.4	4.5	4.7	4.9	4.7
60.0				2.7	3.3			3.1	3.5	3.4		3.1	3.5	3.8	3.7	3.3	3.4	3.6	3.8	3.7
64.0									2.6	2.5			2.6	2.9	2.7		2.4	2.7	2.9	2.7
68.0										1.7				2.0	1.9			1.9	2.1	1.9
72.0																				
76.0																				
80.0																				

MB + LFJ + PS

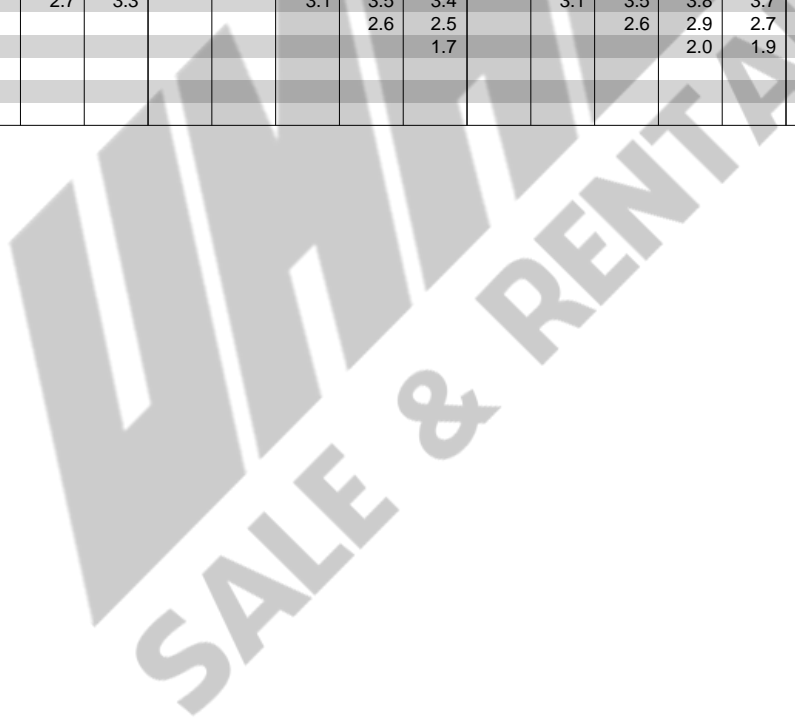

Tragfähigkeiten
Lifting capacities
Capacités de levage
Capacidades de elevación



m	LFJ 6.0 m					LFJ 12.0 m					LFJ 18.0 m					LFJ 24.0 m				
	40.4 m	45.4 m	50.5 m	55.6 m	60.0 m	40.4 m	45.4 m	50.5 m	55.6 m	60.0 m	40.4 m	45.4 m	50.5 m	55.6 m	60.0 m	40.4 m	45.4 m	50.5 m	55.6 m	60.0 m
7.0	58.6																			
8.0	58.6	51.1																		
9.0	58.6	51.1	39.9			47.4														
10.0	58.6	51.1	38.3	31.8		47.4	38.4				33.3				23.7					
11.0	58.6	51.1	36.8	30.6	28.1	47.4	38.4	31.2			33.3				23.7					
12.0	55.1	51.1	35.5	29.4	28.0	47.4	38.4	29.9	23.9		33.2	29.1			23.7	20.9				
14.0	45.3	44.4	33.2	27.3	26.1	44.6	38.4	27.7	23.9	20.9	31.1	29.1	22.8	17.9	23.0	20.9	16.8			
16.0	37.9	37.3	31.1	25.6	24.4	37.6	36.9	25.8	22.3	20.9	29.1	28.5	22.6	17.9	15.8	21.6	20.9	16.8	13.2	
18.0	32.1	31.8	29.4	24.0	23.0	32.1	31.6	24.2	20.8	19.9	27.3	27.0	21.0	17.9	15.4	20.4	19.9	16.8	13.2	11.2
20.0	27.5	27.3	27.4	22.7	21.8	27.6	27.3	22.8	19.5	18.7	25.5	25.7	19.7	17.2	15.0	19.2	19.0	16.8	13.2	10.9
22.0	23.5	23.6	23.8	21.5	20.6	23.9	23.7	21.5	18.4	17.7	23.9	23.7	18.5	16.1	14.6	18.1	18.0	16.1	13.2	10.6
24.0	19.9	20.5	20.8	20.4	19.6	20.8	20.7	20.4	17.4	16.7	21.1	20.8	17.5	15.2	14.1	17.2	17.2	15.2	13.2	10.2
26.0	16.9	17.5	18.3	18.5	18.1	17.8	18.1	18.2	16.5	15.9	18.6	18.3	16.6	14.4	13.7	16.3	16.4	14.3	12.6	9.8
28.0	14.4	15.0	15.8	16.3	16.0	15.3	15.7	16.1	15.7	15.1	16.2	16.2	15.7	13.6	13.2	15.4	15.7	13.6	11.9	9.4
30.0	12.3	12.9	13.7	14.2	14.2	13.2	13.6	14.1	14.5	14.1	14.1	14.2	14.5	12.9	12.6	14.6	14.3	12.9	11.3	9.0
32.0	10.5	11.1	11.9	12.4	12.5	11.4	11.8	12.3	12.8	12.5	12.2	12.4	12.9	12.3	11.9	12.8	12.7	12.3	10.8	8.7
34.0	8.9	9.5	10.3	10.8	11.0	9.8	10.2	10.7	11.3	11.2	10.7	10.8	11.3	11.6	11.1	11.2	11.2	11.4	10.2	8.3
36.0	7.6	8.1	8.9	9.5	9.6	8.4	8.8	9.3	9.9	9.8	9.3	9.4	9.9	10.2	10.0	9.8	9.8	10.1	9.8	7.9
38.0	6.4	6.9	7.7	8.2	8.4	7.2	7.6	8.1	8.6	8.6	8.1	8.2	8.7	9.0	8.9	8.5	8.6	8.8	9.1	7.5
40.0	5.4	5.9	6.6	7.2	7.3	6.2	6.5	7.0	7.6	7.5	7.0	7.1	7.6	7.9	7.8	7.4	7.5	7.7	8.0	7.1
44.0	3.6	4.1	4.8	5.3	5.5	4.4	4.7	5.2	5.7	5.6	5.1	5.3	5.7	6.0	5.9	5.6	5.6	5.9	6.1	5.9
48.0		2.6	3.3	3.9	4.0	2.9	3.2	3.7	4.2	4.1	3.6	3.8	4.2	4.5	4.4	4.1	4.1	4.4	4.6	4.4
52.0			2.1	2.6	2.7		2.0	2.5	3.0	2.9	2.4	2.5	3.0	3.3	3.2	2.8	2.9	3.1	3.3	3.2
56.0				1.6	1.7				1.9	1.8			1.5	1.9	2.2	2.1	1.7	1.8	2.0	2.2
60.0																				
64.0																				
68.0																				
72.0																				
76.0																				
80.0																				

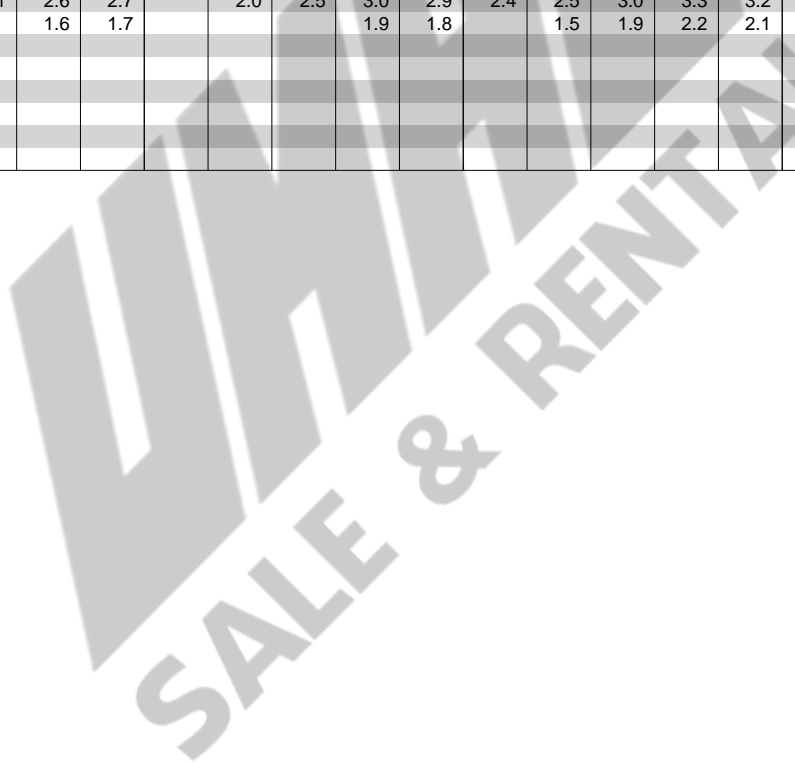

Notizen
Notes
Notas



UNIVERSAL
SALE & RENTAL

Hubhöhen
Lifting heights
Hauteurs de levage
Alturas de elevación

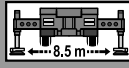
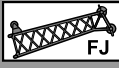
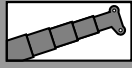

138t Heavy Duty

DIN/ISO/EN

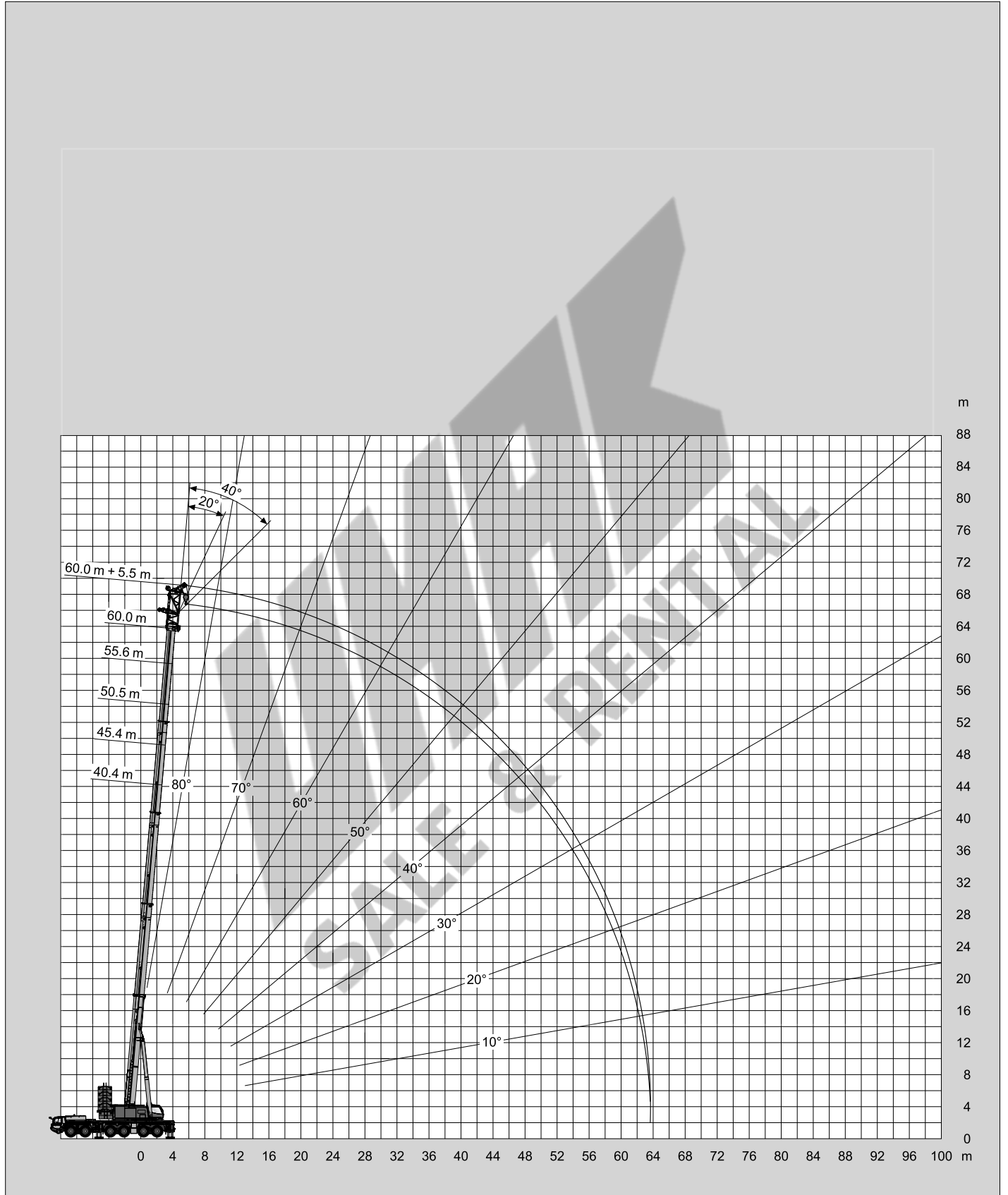





Tragfähigkeiten
Lifting capacities
Capacités de levage
Capacidades de elevación



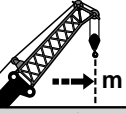

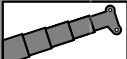

138t Heavy Duty
DIN/ISO/EN

 m	40.4 m + 5.5 m			45.4 m + 5.5 m			50.5 m + 5.5 m			55.6 m + 5.5 m			60.0 m + 5.5 m		
	0°	20°	40°	0°	20°	40°	0°	20°	40°	0°	20°	40°	0°	20°	40°
7.0	51.5														
8.0	48.2	45.4		40.6											
9.0	45.4	42.9	41.3	38.4	35.9		30.2								
10.0	42.9	40.7	39.3	36.5	34.3	32.8	28.7	27.0		25.3					
11.0	40.7	38.8	37.5	34.8	32.8	31.4	27.3	25.7	24.7	24.1	22.6		22.9		
12.0	38.7	37.0	35.8	33.2	31.4	30.2	26.0	24.6	23.7	23.0	21.7	20.7	21.8	20.6	
14.0	35.3	33.9	33.0	30.6	29.1	28.1	23.8	22.7	21.9	21.0	20.2	19.4	19.9	19.1	18.4
16.0	32.5	31.3	30.6	28.4	27.1	26.3	22.0	21.2	20.5	19.4	18.7	18.2	18.4	17.7	17.3
18.0	30.2	29.2	28.6	26.3	25.4	24.7	20.5	19.7	19.2	18.0	17.4	17.0	17.0	16.5	16.1
20.0	28.1	27.3	26.8	24.5	23.9	23.3	19.2	18.5	18.0	16.8	16.3	15.9	15.9	15.4	15.1
22.0	26.4	25.7	25.3	22.9	22.3	22.0	18.0	17.4	17.1	15.7	15.3	15.0	14.9	14.5	14.2
24.0	24.9	24.2	23.9	21.5	21.0	20.8	17.0	16.5	16.2	14.8	14.4	14.2	14.0	13.6	13.4
26.0	23.5	23.0	22.7	20.3	19.9	19.7	16.2	15.7	15.4	14.0	13.6	13.4	13.2	12.9	12.7
28.0	22.1	21.9	21.7	19.2	18.8	18.7	15.4	14.9	14.7	13.3	13.0	12.8	12.5	12.2	12.1
30.0	20.7	20.7	20.7	18.2	17.9	17.8	14.7	14.3	14.1	12.6	12.3	12.2	11.9	11.7	11.5
32.0	19.5	19.5	19.4	17.3	17.1	17.0	14.0	13.7	13.5	12.0	11.8	11.6	11.3	11.1	11.0
34.0	18.4	18.4	18.4	16.6	16.3	16.2	13.5	13.2	13.0	11.5	11.3	11.2	10.8	10.6	10.5
36.0	17.4	17.4	17.4	15.9	15.7	15.6	13.0	12.7	12.6	11.0	10.8	10.7	10.4	10.2	10.1
38.0	16.5	16.5		15.3	15.1	15.0	12.5	12.3	12.2	10.6	10.4	10.3	9.9	9.8	9.7
40.0	15.8	15.8		14.7	14.5	14.5	12.1	11.9	11.8	10.2	10.0	10.0	9.6	9.4	9.3
44.0				13.2	13.3		11.4	11.2	11.2	9.5	9.4	9.3	8.9	8.7	8.7
48.0				10.6			10.9	10.8		8.9	8.8	8.8	8.3	8.2	8.2
52.0							10.1	10.2		8.5	8.4		7.6	7.7	7.7
56.0										8.2	8.2		6.6	6.6	
60.0													5.7	5.7	

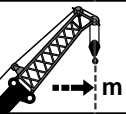



118t Heavy Duty
DIN/ISO/EN

 m	40.4 m + 5.5 m			45.4 m + 5.5 m			50.5 m + 5.5 m			55.6 m + 5.5 m			60.0 m + 5.5 m		
	0°	20°	40°	0°	20°	40°	0°	20°	40°	0°	20°	40°	0°	20°	40°
7.0	51.5														
8.0	48.2	45.4		40.6											
9.0	45.4	42.9	41.3	38.4	35.9		30.2								
10.0	42.9	40.7	39.3	36.5	34.3	32.8	28.7	27.0		25.3					
11.0	40.7	38.8	37.5	34.8	32.8	31.4	27.3	25.7	24.7	24.1	22.6		22.9		
12.0	38.7	37.0	35.8	33.2	31.4	30.2	26.0	24.6	23.7	23.0	21.7	20.7	21.8	20.6	
14.0	35.3	33.9	33.0	30.6	29.1	28.1	23.8	22.7	21.9	21.0	20.2	19.4	19.9	19.1	18.4
16.0	32.5	31.3	30.6	28.4	27.1	26.3	22.0	21.1	20.5	19.4	18.7	18.2	18.4	17.7	17.3
18.0	30.2	29.2	28.6	26.3	25.4	24.7	20.5	19.7	19.2	18.0	17.4	17.0	17.0	16.5	16.1
20.0	28.1	27.3	26.8	24.5	23.9	23.3	19.2	18.5	18.0	16.8	16.3	15.9	15.9	15.4	15.1
22.0	26.4	25.7	25.3	22.9	22.3	22.0	18.0	17.4	17.1	15.7	15.3	15.0	14.9	14.5	14.2
24.0	24.9	24.2	23.9	21.5	21.0	20.8	17.0	16.5	16.2	14.8	14.4	14.2	14.0	13.6	13.4
26.0	23.5	23.0	22.7	20.3	19.9	19.7	16.2	15.7	15.4	14.0	13.6	13.4	13.2	12.9	12.7
28.0	22.1	21.9	21.7	19.2	18.8	18.7	15.4	14.9	14.7	13.3	13.0	12.8	12.5	12.2	12.1
30.0	20.7	20.7	20.7	18.2	17.9	17.8	14.7	14.3	14.1	12.6	12.3	12.2	11.9	11.7	11.5
32.0	19.5	19.5	19.4	17.3	17.1	17.0	14.0	13.7	13.5	12.0	11.8	11.6	11.3	11.1	11.0
34.0	18.4	18.4	18.4	16.6	16.3	16.2	13.5	13.2	13.0	11.5	11.3	11.2	10.8	10.6	10.5
36.0	17.4	17.4	17.4	15.9	15.7	15.6	13.0	12.7	12.6	11.0	10.8	10.7	10.4	10.2	10.1
38.0	16.5	16.5		15.3	15.1	15.0	12.5	12.3	12.2	10.6	10.4	10.3	9.9	9.8	9.7
40.0	15.8	15.8		14.7	14.5	14.5	12.1	11.9	11.8	10.2	10.0	10.0	9.6	9.4	9.3
44.0				13.2	13.3		11.4	11.2	11.2	9.5	9.4	9.3	8.9	8.7	8.7
48.0				10.6			10.9	10.8		8.9	8.8	8.8	8.3	8.2	8.2
52.0							10.1	10.1		8.5	8.4		7.6	7.7	7.7
56.0										8.2	8.2		6.6	6.6	
60.0													5.7	5.7	

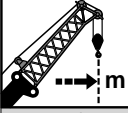
Tragfähigkeiten
Lifting capacities
Capacités de levage
Capacidades de elevación



	40.4 m + 5.5 m			45.4 m + 5.5 m			50.5 m + 5.5 m			55.6 m + 5.5 m			60.0 m + 5.5 m		
	0°	20°	40°	0°	20°	40°	0°	20°	40°	0°	20°	40°	0°	20°	40°
7.0	51.5														
8.0	48.2	45.4		40.6											
9.0	45.4	42.9	41.3	38.4	35.9		30.2								
10.0	42.9	40.7	39.3	36.5	34.3	32.8	28.7	27.0		25.3					
11.0	40.7	38.8	37.5	34.8	32.8	31.4	27.3	25.7	24.7	24.1	22.6		22.9		
12.0	38.7	37.0	35.8	33.2	31.4	30.2	26.0	24.6	23.7	23.0	21.7	20.7	21.8	20.6	
14.0	35.3	33.9	33.0	30.6	29.1	28.1	23.8	22.7	21.9	21.0	20.2	19.4	19.9	19.1	18.4
16.0	32.5	31.3	30.6	28.4	27.1	26.3	22.0	21.1	20.5	19.4	18.7	18.2	18.4	17.7	17.3
18.0	30.2	29.2	28.6	26.3	25.4	24.7	20.5	19.7	19.2	18.0	17.4	17.0	17.0	16.5	16.1
20.0	26.0	26.6	26.8	24.5	23.9	23.3	19.2	18.5	18.0	16.8	16.3	15.9	15.9	15.4	15.1
22.0	22.1	22.6	22.9	22.1	22.3	22.0	18.0	17.4	17.1	15.7	15.3	15.0	14.9	14.5	14.2
24.0	18.6	19.0	19.3	18.9	19.4	19.7	17.0	16.5	16.2	14.8	14.4	14.2	14.0	13.6	13.4
26.0	15.8	16.2	16.4	16.1	16.5	16.8	16.2	15.7	15.4	14.0	13.6	13.4	13.2	12.9	12.7
28.0	13.4	13.7	13.9	13.8	14.1	14.3	14.4	14.8	14.7	13.3	13.0	12.8	12.5	12.2	12.1
30.0	11.4	11.7	11.8	11.8	12.1	12.2	12.5	12.8	12.9	12.6	12.3	12.2	11.9	11.7	11.5
32.0	9.7	10.0	10.1	10.1	10.3	10.5	10.7	11.0	11.2	11.3	11.6	11.6	11.3	11.1	11.0
34.0	8.3	8.5	8.5	8.6	8.8	8.9	9.3	9.5	9.6	9.9	10.1	10.2	9.9	10.2	10.4
36.0	7.0	7.2	7.2	7.3	7.5	7.6	8.0	8.2	8.3	8.6	8.8	8.9	8.6	8.9	9.0
38.0	5.9	6.0		6.2	6.4	6.4	6.8	7.0	7.1	7.4	7.6	7.7	7.5	7.7	7.8
40.0	4.9	5.0		5.2	5.4	5.4	5.8	6.0	6.1	6.4	6.6	6.7	6.5	6.7	6.7
44.0				3.6	3.7		4.2	4.3	4.3	4.7	4.8	4.9	4.7	4.9	5.0
48.0				2.3			2.8	2.9		3.3	3.4	3.4	3.3	3.5	3.5
52.0							1.7	1.7		2.2	2.2		2.2	2.3	2.3





UNIVERSAL
SALE & RENTAL

Hubhöhen
Lifting heights
Hauteurs de levage
Alturas de elevación

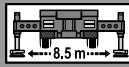
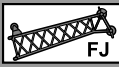
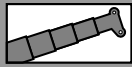

138t

DIN/ISO/EN

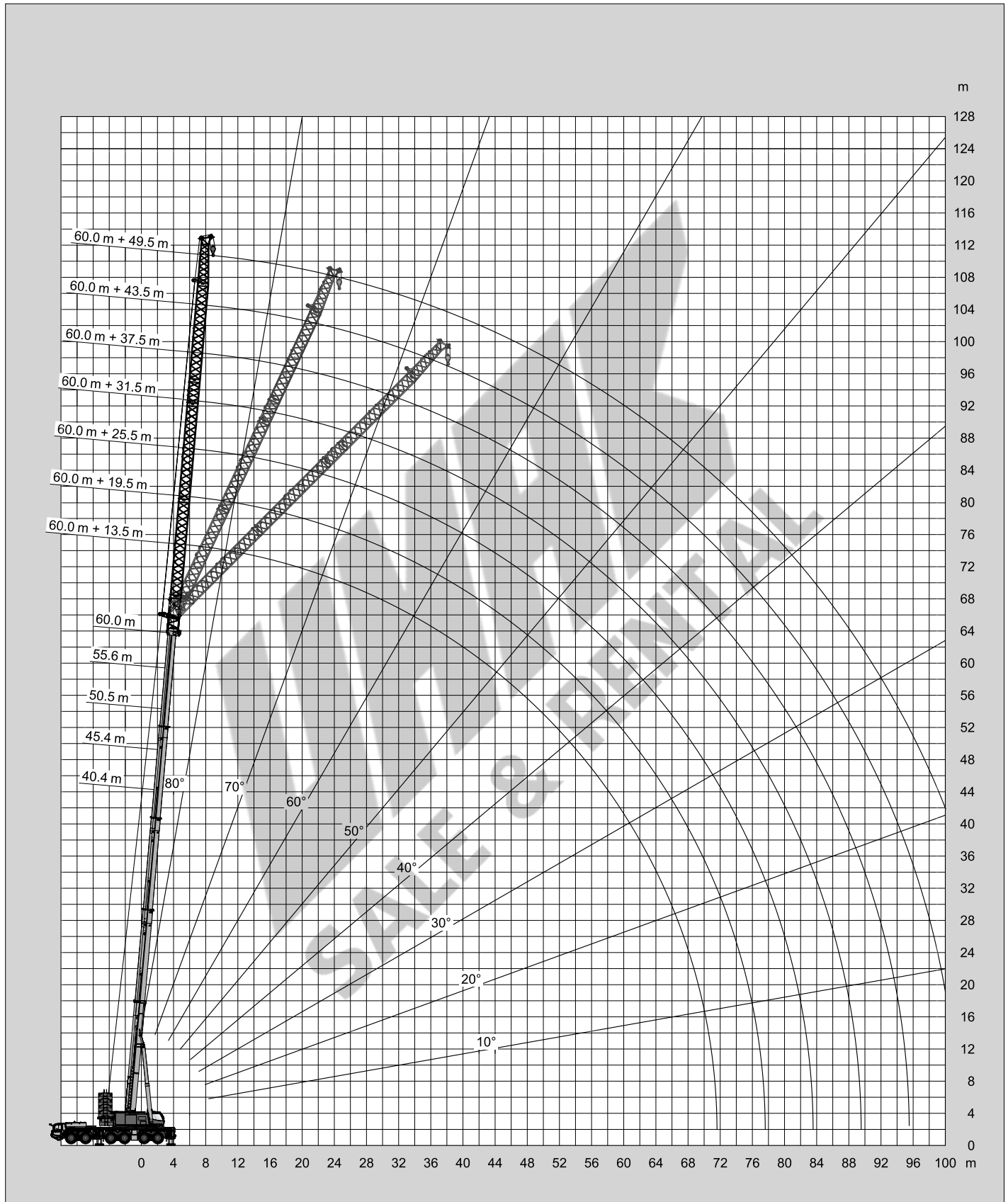

Tragfähigkeiten
Lifting capacities
Capacités de levage
Capacidades de elevación



m	40.4 m + 13.5 m			45.4 m + 13.5 m			50.5 m + 13.5 m			55.6 m + 13.5 m			60.0 m + 13.5 m		
	0°	20°	40°	0°	20°	40°	0°	20°	40°	0°	20°	40°	0°	20°	40°
8.0	43.7														
9.0	41.7			35.1											
10.0	39.2			33.2			26.1								
11.0	37.1			31.5			24.8				21.8				
12.0	35.1	29.2		29.9			23.5				20.8			19.6	
14.0	31.9	27.6		27.3	23.7		21.4	18.0			19.0			18.0	
16.0	29.1	26.1	22.7	25.1	22.1	20.1	19.6	16.9			17.6	15.0		16.6	14.2
18.0	26.9	24.5	21.8	23.3	20.6	19.0	18.1	16.0	14.1		16.2	14.1	12.7	15.3	13.4
20.0	24.9	22.9	21.0	21.7	19.4	17.9	16.9	15.2	13.5		15.0	13.3	12.1	14.2	12.6
22.0	23.3	21.5	20.3	20.3	18.3	17.0	15.8	14.3	13.0		14.0	12.6	11.5	13.2	12.0
24.0	21.8	20.2	19.2	19.1	17.3	16.2	14.8	13.5	12.5		13.1	12.0	11.0	12.4	11.4
26.0	20.5	19.1	18.3	18.1	16.5	15.5	13.9	12.8	12.0		12.4	11.4	10.6	11.6	10.8
28.0	19.4	18.1	17.4	17.1	15.7	14.8	13.2	12.1	11.5		11.7	10.9	10.1	11.0	10.3
30.0	18.4	17.3	16.6	16.2	15.0	14.2	12.5	11.6	11.0		11.0	10.3	9.8	10.4	9.7
32.0	17.4	16.5	15.9	15.4	14.4	13.7	11.9	11.0	10.5		10.5	9.8	9.4	9.8	9.3
34.0	16.6	15.8	15.3	14.6	13.8	13.2	11.3	10.6	10.1		9.9	9.4	9.0	9.4	8.8
36.0	15.9	15.1	14.7	13.9	13.3	12.7	10.8	10.1	9.7		9.5	9.0	8.6	8.9	8.4
38.0	15.2	14.5	14.1	13.3	12.8	12.3	10.4	9.7	9.4		9.0	8.6	8.3	8.5	8.1
40.0	14.6	14.0	13.7	12.7	12.3	12.0	10.0	9.4	9.0		8.7	8.2	8.0	8.1	7.7
44.0	13.4	13.1	12.9	11.8	11.4	11.2	9.2	8.7	8.5		8.0	7.6	7.4	7.5	7.1
48.0	11.9	12.0		10.9	10.6	10.5	8.6	8.2	8.0		7.4	7.1	6.9	6.9	6.6
52.0				9.9	10.0		8.1	7.8	7.6		6.9	6.6	6.5	6.1	6.0
56.0				7.2			7.8	7.5			6.5	6.3	6.2	5.4	5.3
60.0							7.5	7.3			6.2	6.0		4.8	4.7
64.0											5.9	5.8		4.3	4.3
68.0														3.8	3.8



m	40.4 m + 19.5 m			45.4 m + 19.5 m			50.5 m + 19.5 m			55.6 m + 19.5 m			60.0 m + 19.5 m		
	0°	20°	40°	0°	20°	40°	0°	20°	40°	0°	20°	40°	0°	20°	40°
9.0	34.2														
10.0	32.8			29.9											
11.0	31.5			28.7			22.6								
12.0	30.3			27.3			21.5				18.8				
14.0	28.1			24.8			19.7				17.1			16.2	
16.0	26.3	20.6		22.8	19.2		18.1				15.8			14.9	
18.0	24.7	19.5		21.1	18.0		16.7	13.5			14.6	12.1		13.8	
20.0	23.0	18.6	16.0	19.6	17.0		15.5	12.8			13.6	11.4		12.9	10.8
22.0	21.4	17.8	15.4	18.3	16.0	14.6	14.4	12.2	10.6		12.7	10.8		12.1	10.3
24.0	20.1	17.1	14.9	17.2	15.1	13.8	13.5	11.6	10.2		12.0	10.2	9.1	11.3	9.7
26.0	18.8	16.4	14.5	16.2	14.3	13.2	12.7	11.1	9.8		11.2	9.7	8.7	10.6	9.3
28.0	17.8	15.8	14.0	15.3	13.6	12.6	11.9	10.6	9.4		10.6	9.3	8.4	10.0	8.8
30.0	16.8	15.3	13.6	14.5	13.0	12.1	11.3	10.2	9.1		10.0	8.9	8.1	9.4	8.4
32.0	15.9	14.8	13.3	13.8	12.4	11.6	10.7	9.7	8.8		9.4	8.5	7.8	8.9	8.1
34.0	15.1	14.1	13.0	13.1	11.9	11.2	10.2	9.3	8.5		8.9	8.1	7.5	8.4	7.7
36.0	14.4	13.5	12.7	12.6	11.4	10.8	9.7	8.9	8.3		8.5	7.8	7.2	8.0	7.4
38.0	13.8	12.9	12.4	12.0	11.0	10.4	9.2	8.5	8.0		8.1	7.5	7.0	7.6	7.1
40.0	13.2	12.4	12.0	11.5	10.6	10.0	8.8	8.1	7.7		7.7	7.2	6.8	7.3	6.8
44.0	12.1	11.5	11.2	10.6	9.9	9.4	8.1	7.5	7.2		7.0	6.6	6.4	6.6	6.0
48.0	11.3	10.8	10.5	9.8	9.3	8.9	7.5	7.0	6.8		6.5	6.1	5.9	5.9	5.6
52.0	10.2	10.1		9.1	8.8	8.5	7.0	6.6	6.4		6.0	5.7	5.5	5.1	5.0
56.0	9.1	9.2		8.3	8.3		6.6	6.2	6.1		5.5	5.3	5.2	4.5	4.4
60.0				7.4	7.5		6.2	5.9	5.8		5.0	4.8	4.8	3.9	3.9
64.0							6.0	5.7			4.6	4.5	4.4	3.4	3.4
68.0											4.3	4.2		3.0	3.0
72.0											3.6	4.0		2.6	2.7
76.0														2.3	2.4

Tragfähigkeiten
Lifting capacities
Capacités de levage
Capacidades de elevación



m	40.4 m + 25.5 m			45.4 m + 25.5 m			50.5 m + 25.5 m			55.6 m + 25.5 m			60.0 m + 25.5 m		
	0°	20°	40°	0°	20°	40°	0°	20°	40°	0°	20°	40°	0°	20°	40°
10.0	27.8														
11.0	26.7														
12.0	25.7														
14.0	23.9				23.6			19.5						14.8	
16.0	22.2				20.7			17.8				15.6		13.6	
18.0	20.8	16.1			19.4			16.3				14.3		12.6	
20.0	19.6	15.3			18.1	14.4		15.1				13.2		11.7	
22.0	18.5	14.6			16.9	13.8		14.1				12.3		10.9	
24.0	17.5	13.9			15.8	13.2		13.2	10.4			11.5	9.4	10.2	8.5
26.0	16.6	13.3	10.9		14.8	12.6	10.8	12.3	9.9			10.8	8.9	10.2	8.5
28.0	15.8	12.8	10.6		14.0	12.2	10.5	11.5	9.5			10.1	8.4	9.6	8.1
30.0	15.1	12.3	10.3		13.2	11.6	10.2	10.9	9.0	7.9		9.5	8.0	9.1	7.7
32.0	14.5	11.9	10.0		12.5	11.1	9.9	10.2	8.7	7.6		9.0	7.6	8.6	7.3
34.0	13.9	11.4	9.8		11.9	10.6	9.7	9.7	8.3	7.3		8.6	7.3	8.1	7.0
36.0	13.3	11.1	9.5		11.3	10.1	9.4	8.7	7.7	6.8		8.1	7.0	7.7	6.7
38.0	12.7	10.7	9.3		10.8	9.7	9.0	8.7	7.7	6.8		7.7	6.7	7.3	6.4
40.0	12.1	10.4	9.1		10.4	9.3	8.7	8.3	7.4	6.6		7.3	6.4	6.9	6.1
44.0	11.1	9.8	8.8		9.5	8.6	8.1	7.9	7.1	6.4		6.9	6.2	6.5	5.9
48.0	10.2	9.3	8.5		8.8	8.1	7.6	7.2	6.6	6.1		6.3	5.7	5.3	5.4
52.0	9.5	8.9	8.4		8.2	7.5	7.2	6.6	6.1	5.8		5.7	5.3	4.9	4.8
56.0	8.7	8.5	8.3		7.7	7.1	6.8	6.6	6.1	5.7		5.1	4.8	4.7	4.3
60.0	7.7	7.9			7.1	6.8	6.6	6.1	5.7	5.4		4.5	4.3	4.2	3.7
64.0					6.2	6.4		5.2	4.9	4.7		4.1	3.9	3.8	3.1
68.0					4.1			4.8	4.5	4.4		3.6	3.5	3.4	2.7
72.0								4.4	4.2			3.3	3.1	3.1	2.3
76.0								4.2	4.0			3.0	2.9	2.8	1.9
												2.8	2.7	2.7	1.7



m	40.4 m + 31.5 m			45.4 m + 31.5 m			50.5 m + 31.5 m			55.6 m + 31.5 m			60.0 m + 31.5 m		
	0°	20°	40°	0°	20°	40°	0°	20°	40°	0°	20°	40°	0°	20°	40°
11.0	22.7														
12.0	21.9														
14.0	20.4				20.2										
16.0	19.0				18.9										
18.0	17.8				17.7										
20.0	16.7				16.7										
22.0	15.8	11.5			15.7										
24.0	14.9	10.9			14.9										
26.0	14.1	10.4			14.1	10.8									
28.0	13.4	10.0			13.4	10.3									
30.0	12.8	9.6	7.8		12.7	9.9									
32.0	12.2	9.2	7.5		12.1	9.5									
34.0	11.6	8.8	7.3		11.4	9.1	7.5								
36.0	11.1	8.5	7.1		10.8	8.8	7.3								
38.0	10.6	8.2	6.9		10.3	8.5	7.1								
40.0	10.1	7.9	6.8		9.9	8.2	6.9								
44.0	9.3	7.4	6.4		9.3	7.9	6.7								
48.0	8.6	7.0	6.2		8.5	7.4	6.4								
52.0	8.0	6.6	6.0		7.8	7.0	6.1								
56.0	7.5	6.3	5.8		7.2	6.6	5.9								
60.0	7.0	6.1	5.7		6.7	6.1	5.7								
64.0	6.4	5.9	5.7		6.2	5.7	5.4								
68.0	5.3	5.9			5.6	5.3	5.1								
72.0					5.1	4.9	4.8								
76.0					4.4	4.5									
80.0															
84.0															

Tragfähigkeiten
Lifting capacities
Capacités de levage
Capacidades de elevación

m	40.4 m + 37.5 m			45.4 m + 37.5 m			50.5 m + 37.5 m			55.6 m + 37.5 m			60.0 m + 37.5 m		
	0°	20°	40°	0°	20°	40°	0°	20°	40°	0°	20°	40°	0°	20°	40°
12.0	18.3														
14.0	17.2			15.9											
16.0	16.2			15.1			13.5			11.0					
18.0	15.3			14.3			12.9			11.0			9.7		
20.0	14.5			13.6			12.1			10.7			9.7		
22.0	13.7			12.9			11.3			9.9			9.5		
24.0	12.8			12.3			10.5			9.2			8.8		
26.0	12.0	8.5		11.7	8.4		9.9			8.6			8.2		
28.0	11.3	8.1		11.1	8.1		9.3	7.2		8.1			7.7		
30.0	10.7	7.8		10.6	7.7		8.7	6.9		7.6	6.2		7.3		
32.0	10.1	7.5		10.1	7.4		8.3	6.6		7.2	5.9		6.9	5.4	
34.0	9.6	7.1		9.7	7.1		7.8	6.3		6.8	5.6		6.5	5.0	
36.0	9.1	6.9	5.6	9.2	6.8	5.5	7.4	6.0		6.4	5.3		6.1	4.7	
38.0	8.7	6.6	5.4	8.8	6.6	5.4	7.1	5.7	5.0	6.1	5.1		5.8	4.4	
40.0	8.3	6.3	5.3	8.4	6.3	5.2	6.7	5.5	4.8	5.8	4.9	4.3	5.3	4.1	
44.0	7.6	5.9	5.0	7.7	5.9	4.9	6.1	5.1	4.5	5.2	4.5	3.9	4.5	3.6	3.1
48.0	7.0	5.5	4.7	7.1	5.5	4.7	5.4	4.7	4.2	4.5	4.0	3.5	3.7	3.2	2.7
52.0	6.4	5.2	4.5	6.6	5.2	4.5	4.8	4.3	3.8	3.8	3.6	3.2	3.1	2.8	2.4
56.0	6.0	4.9	4.3	5.9	4.9	4.3	4.2	3.8	3.5	3.3	3.1	2.8	2.6	2.4	2.2
60.0	5.6	4.6	4.2	5.3	4.7	4.1	3.7	3.4	3.2	2.8	2.7	2.6	2.1	2.1	1.9
64.0	5.2	4.4	4.1	4.8	4.3	4.0	3.3	3.0	2.9	2.4	2.3	2.3	1.7	1.7	1.7
68.0	4.9	4.3	4.1	4.4	4.0	3.8	2.9	2.7	2.6	2.0	1.9	1.9			1.5
72.0	4.7	4.2		4.0	3.7	3.5	2.6	2.4	2.3	1.7	1.6	1.6			
76.0				3.6	3.4		2.3	2.1	2.0						
80.0				1.7			2.0	1.9	1.8						
84.0							1.9	1.7							

m	40.4 m + 43.5 m			45.4 m + 43.5 m			50.5 m + 43.5 m			55.6 m + 43.5 m			60.0 m + 43.5 m		
	0°	20°	40°	0°	20°	40°	0°	20°	40°	0°	20°	40°	0°	20°	40°
14.0	14.2														
16.0	13.4			12.3			10.9								
18.0	12.7			11.7			10.5			9.2					
20.0	12.0			11.1			10.0			8.9			8.2		
22.0	11.3			10.5			9.6			8.6			7.9		
24.0	10.6			10.0			9.2			8.2			7.7		
26.0	10.0			9.5			8.8			7.8			7.4		
28.0	9.3	6.5		9.1			8.3			7.3			6.9		
30.0	8.8	6.2		8.7	6.1		7.8			6.8			6.5		
32.0	8.3	5.9		8.3	5.8		7.3	5.7		6.4			6.1		
34.0	7.8	5.6		7.9	5.6		6.9	5.4		6.0	4.9		5.6		
36.0	7.4	5.4		7.5	5.3		6.5	5.2		5.7	4.6		5.1	3.7	
38.0	7.0	5.1		7.1	5.1		6.2	4.9		5.3	4.3		4.7	3.4	
40.0	6.6	4.9	3.9	6.7	4.9		5.9	4.7		5.0	4.0		4.3	3.1	
44.0	6.0	4.5	3.6	6.1	4.5	3.6	5.1	4.2	3.4	4.2	3.4		3.6	2.7	
48.0	5.5	4.1	3.4	5.6	4.2	3.4	4.4	3.7	3.0	3.5	3.0	2.5	2.9	2.3	1.9
52.0	5.0	3.8	3.2	5.1	3.9	3.2	3.8	3.3	2.7	2.9	2.5	2.1	2.3	1.9	1.6
56.0	4.6	3.6	2.9	4.7	3.6	3.0	3.2	2.9	2.4	2.4	2.2	1.8	1.8	1.6	
60.0	4.2	3.3	2.8	4.3	3.3	2.8	2.7	2.5	2.2	1.9	1.8	1.5			
64.0	3.9	3.1	2.6	3.8	3.1	2.6	2.3	2.1	1.9	1.5					
68.0	3.6	2.9	2.5	3.3	2.9	2.5	1.9	1.7	1.6						
72.0	3.3	2.7	2.4	2.9	2.6	2.4	1.6								
76.0	3.1	2.6	2.4	2.6	2.3	2.1									
80.0	2.8	2.5		2.3	2.0	1.9									
84.0				2.1	1.8										

Tragfähigkeiten
Lifting capacities
Capacités de levage
Capacidades de elevación

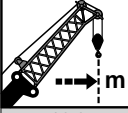

	40.4 m + 49.5 m			45.4 m + 49.5 m			50.5 m + 49.5 m			55.6 m + 49.5 m			60.0 m + 49.5 m		
	0°	20°	40°	0°	20°	40°	0°	20°	40°	0°	20°	40°	0°	20°	40°
16.0	10.7			9.8											
18.0	10.1			9.3			8.2								
20.0	9.6			8.8			7.8			6.8					
22.0	9.0			8.3			7.5			6.5			6.0		
24.0	8.5			7.9			7.1			6.3			5.8		
26.0	8.1			7.5			6.8			6.0			5.6		
28.0	7.6			7.1			6.5			5.8			5.4		
30.0	7.2			6.8			6.2			5.6			5.2		
32.0	6.7	4.6		6.5			5.9			5.3			4.9		
34.0	6.3	4.4		6.2	4.3		5.6			5.1			4.7		
36.0	6.0	4.1		5.9	4.1		5.4	4.0		4.9			4.2		
38.0	5.6	3.9		5.6	3.9		5.2	3.8		4.6	3.4		3.8	2.6	
40.0	5.3	3.7		5.3	3.7		4.9	3.6		4.2	3.1		3.5	2.3	
44.0	4.7	3.4		4.8	3.4		4.4	3.2		3.5	2.6		2.8	1.9	
48.0	4.2	3.0	2.2	4.3	3.0	2.2	3.6	2.8		2.8	2.1		2.2	1.5	
52.0	3.8	2.7	1.9	3.9	2.8	1.9	3.0	2.4	1.8	2.2	1.7		1.8		
56.0	3.4	2.4	1.7	3.5	2.5	1.7	2.5	2.0	1.5	1.7					
60.0	3.1	2.1	1.5	3.2	2.2	1.6	2.0	1.7							
64.0	2.8	1.9		2.9	2.0		1.6								
68.0	2.5	1.7		2.4	1.8										
72.0	2.2	1.5		2.0	1.6										
76.0	1.9			1.7											
80.0	1.7														
84.0	1.5														

WMA SALE & RENTAL

Tragfähigkeiten
Lifting capacities
Capacités de levage
Capacidades de elevación



m	40.4 m + 13.5 m			45.4 m + 13.5 m			50.5 m + 13.5 m			55.6 m + 13.5 m			60.0 m + 13.5 m		
	0°	20°	40°	0°	20°	40°	0°	20°	40°	0°	20°	40°	0°	20°	40°
8.0	43.7														
9.0	41.7			35.1											
10.0	39.2			33.2			26.1								
11.0	37.1			31.5			24.8				21.8				
12.0	35.1	29.2		29.9			23.5				20.8			19.6	
14.0	31.9	27.6		27.3	23.7		21.4	18.0			19.0			18.0	
16.0	29.1	26.1	22.7	25.1	22.1	20.1	19.6	16.9			17.6	15.0		16.6	14.2
18.0	26.9	24.5	21.8	23.3	20.6	19.0	18.1	16.0	14.1		16.2	14.1	12.7	15.3	13.4
20.0	24.9	22.9	21.0	21.7	19.4	17.9	16.9	15.2	13.5		15.0	13.3	12.1	14.2	12.6
22.0	23.3	21.5	20.3	20.3	18.3	17.0	15.8	14.3	13.0		14.0	12.6	11.5	13.2	12.0
24.0	21.8	20.2	19.2	19.1	17.3	16.2	14.8	13.5	12.5		13.1	12.0	11.0	12.4	11.4
26.0	20.5	19.1	18.3	18.1	16.5	15.5	13.9	12.8	12.0		12.4	11.4	10.6	11.6	10.8
28.0	19.4	18.1	17.4	17.1	15.7	14.8	13.2	12.1	11.5		11.7	10.9	10.1	11.0	10.3
30.0	18.4	17.3	16.6	16.2	15.0	14.2	12.5	11.6	11.0		11.0	10.3	9.8	10.4	9.7
32.0	17.4	16.5	15.9	15.4	14.4	13.7	11.9	11.0	10.5		10.5	9.8	9.4	9.8	9.3
34.0	16.6	15.8	15.3	14.6	13.8	13.2	11.3	10.6	10.1		9.9	9.4	9.0	9.4	8.8
36.0	15.9	15.1	14.7	13.9	13.3	12.7	10.8	10.1	9.7		9.5	9.0	8.6	8.9	8.4
38.0	15.2	14.5	14.1	13.3	12.8	12.3	10.4	9.7	9.4		9.0	8.6	8.3	8.5	8.1
40.0	14.6	14.0	13.7	12.7	12.3	12.0	10.0	9.4	9.0		8.7	8.2	8.0	8.1	7.7
44.0	13.4	13.1	12.9	11.8	11.4	11.2	9.2	8.7	8.5		8.0	7.6	7.4	7.5	7.1
48.0	11.8	12.0		10.9	10.6	10.5	8.6	8.2	8.0		7.4	7.1	6.9	6.9	6.6
52.0				9.9	10.0		8.1	7.8	7.6		6.9	6.6	6.5	6.1	6.0
56.0				7.2			7.8	7.5			6.5	6.3	6.2	5.4	5.3
60.0							7.5	7.3			6.2	6.0		4.8	4.7
64.0											5.9	5.8		4.3	4.3
68.0														3.8	3.8

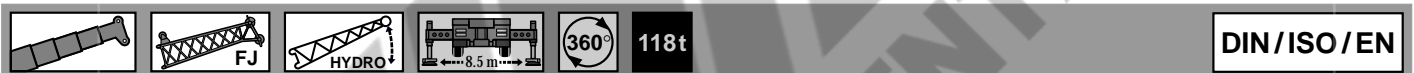

m	40.4 m + 19.5 m			45.4 m + 19.5 m			50.5 m + 19.5 m			55.6 m + 19.5 m			60.0 m + 19.5 m		
	0°	20°	40°	0°	20°	40°	0°	20°	40°	0°	20°	40°	0°	20°	40°
9.0	34.2														
10.0	32.8			29.9											
11.0	31.5			28.7			22.6								
12.0	30.3			27.3			21.5				18.8				
14.0	28.1			24.8			19.7				17.1			16.2	
16.0	26.3	20.6		22.8	19.2		18.1				15.8			14.9	
18.0	24.7	19.5		21.1	18.0		16.7	13.5			14.6	12.1		13.8	
20.0	23.0	18.6	16.0	19.6	17.0		15.5	12.8			13.6	11.4		12.9	10.8
22.0	21.4	17.8	15.4	18.3	16.0	14.6	14.4	12.2	10.6		12.7	10.8		12.1	10.3
24.0	20.1	17.1	14.9	17.2	15.1	13.8	13.5	11.6	10.2		12.0	10.2	9.1	11.3	9.7
26.0	18.8	16.4	14.5	16.2	14.3	13.2	12.7	11.1	9.8		11.2	9.7	8.7	10.6	9.3
28.0	17.8	15.8	14.0	15.3	13.6	12.6	11.9	10.6	9.4		10.6	9.3	8.4	10.0	8.8
30.0	16.8	15.3	13.6	14.5	13.0	12.1	11.3	10.2	9.1		10.0	8.9	8.1	9.4	8.4
32.0	15.9	14.8	13.3	13.8	12.4	11.6	10.7	9.7	8.8		9.4	8.5	7.8	8.9	8.1
34.0	15.1	14.1	13.0	13.1	11.9	11.2	10.2	9.3	8.5		8.9	8.1	7.5	8.4	7.7
36.0	14.4	13.5	12.7	12.6	11.4	10.8	9.7	8.9	8.3		8.5	7.8	7.2	8.0	7.4
38.0	13.8	12.9	12.4	12.0	11.0	10.4	9.2	8.5	8.0		8.1	7.5	7.0	7.6	7.1
40.0	13.2	12.4	12.0	11.5	10.6	10.0	8.8	8.1	7.7		7.7	7.2	6.8	7.3	6.8
44.0	12.1	11.5	11.2	10.6	9.9	9.4	8.1	7.5	7.2		7.0	6.6	6.4	6.6	6.0
48.0	11.3	10.8	10.5	9.8	9.3	8.9	7.5	7.0	6.8		6.5	6.1	5.9	5.9	5.6
52.0	10.2	10.1		9.1	8.8	8.5	7.0	6.6	6.4		6.0	5.7	5.5	5.1	5.0
56.0	8.8	9.0		8.3	8.3		6.6	6.2	6.1		5.5	5.3	5.2	4.5	4.4
60.0				7.4	7.5		6.2	5.9	5.8		5.0	4.8	4.8	3.9	3.9
64.0							6.0	5.7			4.6	4.5	4.4	3.4	3.4
68.0											4.3	4.2		3.0	3.0
72.0											3.6	4.0		2.6	2.7
76.0														2.3	2.4

Tragfähigkeiten
Lifting capacities
Capacités de levage
Capacidades de elevación



m	40.4 m + 25.5 m			45.4 m + 25.5 m			50.5 m + 25.5 m			55.6 m + 25.5 m			60.0 m + 25.5 m		
	0°	20°	40°	0°	20°	40°	0°	20°	40°	0°	20°	40°	0°	20°	40°
10.0	27.8														
11.0	26.7														
12.0	25.7			23.6			19.5								
14.0	23.9			22.1			17.8			15.6			14.8		
16.0	22.2			20.7			16.3			14.3			13.6		
18.0	20.8	16.1		19.4			15.1			13.2			12.6		
20.0	19.6	15.3		18.1	14.4		14.1			12.3			11.7		
22.0	18.5	14.6		16.9	13.8		13.2	10.4		11.5	9.4		10.9		
24.0	17.5	13.9		15.8	13.2		12.3	9.9		10.8	8.9		10.2	8.5	
26.0	16.6	13.3	10.9	14.8	12.6	10.8	11.5	9.5		10.1	8.4		9.6	8.1	
28.0	15.8	12.8	10.6	14.0	12.2	10.5	10.9	9.0	7.9	9.5	8.0		9.1	7.7	
30.0	15.1	12.3	10.3	13.2	11.6	10.2	10.2	8.7	7.6	9.0	7.6	6.8	8.6	7.3	6.5
32.0	14.5	11.9	10.0	12.5	11.1	9.9	9.7	8.3	7.3	8.6	7.3	6.5	8.1	7.0	6.3
34.0	13.9	11.4	9.8	11.9	10.6	9.7	9.2	8.0	7.0	8.1	7.0	6.3	7.7	6.7	6.0
36.0	13.3	11.1	9.5	11.3	10.1	9.4	8.7	7.7	6.8	7.7	6.7	6.1	7.3	6.4	5.8
38.0	12.7	10.7	9.3	10.8	9.7	9.0	8.3	7.4	6.6	7.3	6.4	5.8	6.9	6.1	5.6
40.0	12.1	10.4	9.1	10.4	9.3	8.7	7.9	7.1	6.4	6.9	6.2	5.6	6.5	5.9	5.4
44.0	11.1	9.8	8.8	9.5	8.6	8.1	7.2	6.6	6.1	6.3	5.7	5.3	5.8	5.4	4.9
48.0	10.2	9.3	8.5	8.8	8.1	7.6	6.6	6.1	5.8	5.7	5.3	4.9	5.0	4.8	4.5
52.0	9.5	8.9	8.4	8.2	7.5	7.2	6.1	5.7	5.4	5.1	4.8	4.7	4.3	4.1	4.1
56.0	8.7	8.5	8.3	7.7	7.1	6.8	5.7	5.3	5.1	4.5	4.3	4.2	3.7	3.6	3.6
60.0	7.7	7.9		7.1	6.8	6.6	5.2	4.9	4.7	4.1	3.9	3.8	3.1	3.1	3.2
64.0				6.2	6.4		4.8	4.5	4.4	3.6	3.5	3.4	2.7	2.7	2.8
68.0				4.1			4.4	4.2		3.3	3.1	3.1	2.3	2.3	2.4
72.0							4.2	4.0		3.0	2.9		1.9	2.0	2.1
76.0										2.8	2.7		1.6	1.7	

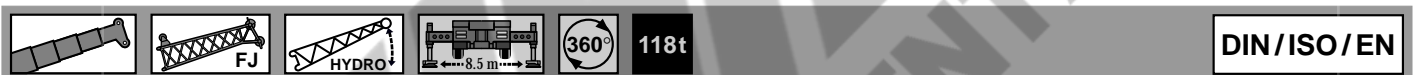

m	40.4 m + 31.5 m			45.4 m + 31.5 m			50.5 m + 31.5 m			55.6 m + 31.5 m			60.0 m + 31.5 m		
	0°	20°	40°	0°	20°	40°	0°	20°	40°	0°	20°	40°	0°	20°	40°
11.0	22.7														
12.0	21.9			20.2											
14.0	20.4			18.9			16.2								
16.0	19.0			17.7			14.8			13.6			12.0		
18.0	17.8			16.7			13.7			12.5			11.9		
20.0	16.7			15.7			12.7			11.6			11.0		
22.0	15.8	11.5		14.9			11.9			10.7			10.2		
24.0	14.9	10.9		14.1	10.8		11.1	8.7		10.0			9.6		
26.0	14.1	10.4		13.4	10.3		10.5	8.2		9.4	7.6		9.0		
28.0	13.4	10.0		12.7	9.9		9.9	7.9		8.8	7.2		8.4	6.9	
30.0	12.8	9.6	7.8	12.1	9.5		9.3	7.5		8.3	6.9		7.9	6.6	
32.0	12.2	9.2	7.5	11.4	9.1	7.5	8.8	7.2		7.9	6.6		7.5	6.3	
34.0	11.6	8.8	7.3	10.8	8.8	7.3	8.3	6.9	6.0	7.5	6.3		7.1	5.9	
36.0	11.1	8.5	7.1	10.3	8.5	7.1	7.9	6.6	5.7	7.1	6.0	5.3	6.7	5.5	4.7
38.0	10.6	8.2	6.9	9.8	8.2	6.9	7.5	6.3	5.5	6.7	5.7	5.1	6.4	5.2	4.4
40.0	10.1	7.9	6.8	9.3	7.9	6.7	7.1	6.1	5.4	6.4	5.5	4.9	5.9	4.9	4.2
44.0	9.3	7.4	6.4	8.5	7.4	6.4	6.4	5.7	5.0	5.8	5.0	4.6	5.0	4.3	3.8
48.0	8.6	7.0	6.2	7.8	7.0	6.1	5.9	5.3	4.7	5.1	4.7	4.2	4.2	3.9	3.4
52.0	8.0	6.6	6.0	7.2	6.6	5.9	5.2	4.8	4.5	4.4	4.2	3.9	3.6	3.4	3.1
56.0	7.5	6.3	5.8	6.7	6.1	5.7	4.7	4.3	4.1	3.9	3.7	3.6	3.0	3.0	2.8
60.0	7.0	6.1	5.7	6.2	5.7	5.4	4.2	3.9	3.7	3.4	3.2	3.1	2.5	2.5	2.5
64.0	6.4	5.9	5.7	5.6	5.3	5.1	3.7	3.5	3.4	2.9	2.8	2.8	2.1	2.1	2.2
68.0	5.3	5.8		5.1	4.9	4.8	3.4	3.2	3.1	2.6	2.5	2.4	1.7	1.8	1.9
72.0				4.4	4.5		3.1	2.9	2.8	2.2	2.1	2.1			1.6
76.0							2.9	2.7		2.0	1.9	1.9			
80.0										1.7	1.6				
84.0										1.6					

Tragfähigkeiten
Lifting capacities
Capacités de levage
Capacidades de elevación



m	40.4 m + 37.5 m			45.4 m + 37.5 m			50.5 m + 37.5 m			55.6 m + 37.5 m			60.0 m + 37.5 m		
	0°	20°	40°	0°	20°	40°	0°	20°	40°	0°	20°	40°	0°	20°	40°
12.0	18.3														
14.0	17.2			15.9											
16.0	16.2			15.1			13.5			11.0					
18.0	15.3			14.3			12.9			11.0			9.7		
20.0	14.5			13.6			12.1			10.7			9.7		
22.0	13.7			12.9			11.3			9.9			9.5		
24.0	12.8			12.3			10.5			9.2			8.8		
26.0	12.0	8.5		11.7	8.4		9.9			8.6			8.2		
28.0	11.3	8.1		11.1	8.1		9.3	7.2		8.1			7.7		
30.0	10.7	7.8		10.6	7.7		8.7	6.9		7.6	6.2		7.3		
32.0	10.1	7.5		10.1	7.4		8.3	6.6		7.2	5.9		6.9	5.4	
34.0	9.6	7.1		9.7	7.1		7.8	6.3		6.8	5.6		6.5	5.0	
36.0	9.1	6.9	5.6	9.2	6.8	5.5	7.4	6.0		6.4	5.3		6.1	4.7	
38.0	8.7	6.6	5.4	8.8	6.6	5.4	7.1	5.7	5.0	6.1	5.1		5.8	4.4	
40.0	8.3	6.3	5.3	8.4	6.3	5.2	6.7	5.5	4.8	5.8	4.9	4.3	5.3	4.1	
44.0	7.6	5.9	5.0	7.7	5.9	4.9	6.1	5.1	4.5	5.2	4.5	3.9	4.5	3.6	3.1
48.0	7.0	5.5	4.7	7.1	5.5	4.7	5.4	4.7	4.2	4.5	4.0	3.5	3.7	3.2	2.7
52.0	6.4	5.2	4.5	6.6	5.2	4.5	4.8	4.3	3.8	3.8	3.6	3.2	3.1	2.8	2.4
56.0	6.0	4.9	4.3	5.9	4.9	4.3	4.2	3.8	3.5	3.3	3.1	2.8	2.6	2.4	2.2
60.0	5.6	4.6	4.2	5.3	4.7	4.1	3.7	3.4	3.2	2.8	2.7	2.6	2.1	2.1	1.9
64.0	5.2	4.4	4.1	4.8	4.3	4.0	3.3	3.0	2.9	2.4	2.3	2.3	1.7	1.7	1.7
68.0	4.9	4.3	4.1	4.4	4.0	3.8	2.9	2.7	2.6	2.0	1.9	1.9			1.5
72.0	4.7	4.2		4.0	3.7	3.5	2.6	2.4	2.3	1.7	1.6	1.6			
76.0				3.6	3.4		2.3	2.1	2.0						
80.0				1.7			2.0	1.9	1.8						
84.0							1.9	1.7							



m	40.4 m + 43.5 m			45.4 m + 43.5 m			50.5 m + 43.5 m			55.6 m + 43.5 m			60.0 m + 43.5 m		
	0°	20°	40°	0°	20°	40°	0°	20°	40°	0°	20°	40°	0°	20°	40°
14.0	14.2														
16.0	13.4			12.3			10.9								
18.0	12.7			11.7			10.5			9.2					
20.0	12.0			11.1			10.0			8.9			8.2		
22.0	11.3			10.5			9.6			8.6			7.9		
24.0	10.6			10.0			9.2			8.2			7.7		
26.0	10.0			9.5			8.8			7.8			7.4		
28.0	9.3	6.5		9.1			8.3			7.3			6.9		
30.0	8.8	6.2		8.7	6.1		7.8			6.8			6.5		
32.0	8.3	5.9		8.3	5.8		7.3	5.7		6.4			6.1		
34.0	7.8	5.6		7.9	5.6		6.9	5.4		6.0	4.9		5.6		
36.0	7.4	5.4		7.5	5.3		6.5	5.2		5.7	4.6		5.1	3.7	
38.0	7.0	5.1		7.1	5.1		6.2	4.9		5.3	4.3		4.7	3.4	
40.0	6.6	4.9	3.9	6.7	4.9		5.9	4.7		5.0	4.0		4.3	3.1	
44.0	6.0	4.5	3.6	6.1	4.5	3.6	5.1	4.2	3.4	4.2	3.4		3.6	2.7	
48.0	5.5	4.1	3.4	5.6	4.2	3.4	4.4	3.7	3.0	3.5	3.0	2.5	2.9	2.3	1.9
52.0	5.0	3.8	3.2	5.1	3.9	3.2	3.8	3.3	2.7	2.9	2.5	2.1	2.3	1.9	1.6
56.0	4.6	3.6	2.9	4.7	3.6	3.0	3.2	2.9	2.4	2.4	2.2	1.8	1.8	1.6	
60.0	4.2	3.3	2.8	4.3	3.3	2.8	2.7	2.5	2.2	1.9	1.8	1.5			
64.0	3.9	3.1	2.6	3.8	3.1	2.6	2.3	2.1	1.9	1.5					
68.0	3.6	2.9	2.5	3.3	2.9	2.5	1.9	1.7	1.6						
72.0	3.3	2.7	2.4	2.9	2.6	2.4	1.6								
76.0	3.1	2.6	2.4	2.6	2.3	2.1									
80.0	2.8	2.5		2.3	2.0	1.9									
84.0				2.1	1.8										

Tragfähigkeiten
Lifting capacities
Capacités de levage
Capacidades de elevación

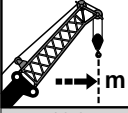

 m	40.4 m + 49.5 m			45.4 m + 49.5 m			50.5 m + 49.5 m			55.6 m + 49.5 m			60.0 m + 49.5 m		
	0°	20°	40°	0°	20°	40°	0°	20°	40°	0°	20°	40°	0°	20°	40°
16.0	10.7			9.8											
18.0	10.1			9.3			8.2								
20.0	9.6			8.8			7.8			6.8					
22.0	9.0			8.3			7.5			6.5			6.0		
24.0	8.5			7.9			7.1			6.3			5.8		
26.0	8.1			7.5			6.8			6.0			5.6		
28.0	7.6			7.1			6.5			5.8			5.4		
30.0	7.2			6.8			6.2			5.6			5.2		
32.0	6.7	4.6		6.5			5.9			5.3			4.9		
34.0	6.3	4.4		6.2	4.3		5.6			5.1			4.7		
36.0	6.0	4.1		5.9	4.1		5.4	4.0		4.9			4.2		
38.0	5.6	3.9		5.6	3.9		5.2	3.8		4.6	3.4		3.8	2.6	
40.0	5.3	3.7		5.3	3.7		4.9	3.6		4.2	3.1		3.5	2.3	
44.0	4.7	3.4		4.8	3.4		4.4	3.2		3.5	2.6		2.8	1.9	
48.0	4.2	3.0	2.2	4.3	3.0	2.2	3.6	2.8		2.8	2.1		2.2	1.5	
52.0	3.8	2.7	1.9	3.9	2.8	1.9	3.0	2.4	1.8	2.2	1.7		1.8		
56.0	3.4	2.4	1.7	3.5	2.5	1.7	2.5	2.0	1.5	1.7					
60.0	3.1	2.1	1.5	3.2	2.2	1.6	2.0	1.7							
64.0	2.8	1.9		2.9	2.0		1.6								
68.0	2.5	1.7		2.4	1.8										
72.0	2.2	1.5		2.0	1.6										
76.0	1.9			1.7											
80.0	1.7														
84.0	1.5														



Tragfähigkeiten
Lifting capacities
Capacités de levage
Capacidades de elevación



m	40.4 m + 13.5 m			45.4 m + 13.5 m			50.5 m + 13.5 m			55.6 m + 13.5 m			60.0 m + 13.5 m		
	0°	20°	40°	0°	20°	40°	0°	20°	40°	0°	20°	40°	0°	20°	40°
8.0	43.7														
9.0	41.7			35.1											
10.0	39.2			33.2			26.1								
11.0	37.1			31.5			24.8				21.8				
12.0	35.1	29.2		29.9			23.5				20.8			19.6	
14.0	31.9	27.6		27.3	23.7		21.4	18.0			19.0			18.0	
16.0	29.1	26.1	22.7	25.1	22.1	20.1	19.6	16.9			17.6	15.0		16.6	14.2
18.0	26.9	24.5	21.8	23.3	20.6	19.0	18.1	16.0	14.1		16.2	14.1	12.7	15.3	13.4
20.0	24.9	22.9	21.0	21.7	19.4	17.9	16.9	15.2	13.5		15.0	13.3	12.1	14.2	12.6
22.0	22.3	21.5	20.3	20.3	18.3	17.0	15.8	14.3	13.0		14.0	12.6	11.5	13.2	12.0
24.0	19.4	20.2	19.2	19.1	17.3	16.2	14.8	13.5	12.5		13.1	12.0	11.0	12.4	11.4
26.0	16.6	18.1	18.3	16.7	16.5	15.5	13.9	12.8	12.0		12.4	11.4	10.6	11.6	10.8
28.0	14.3	15.6	16.6	14.5	15.7	14.8	13.2	12.1	11.5		11.7	10.9	10.1	11.0	10.3
30.0	12.3	13.4	14.3	12.5	13.7	14.2	12.5	11.6	11.0		11.0	10.3	9.8	10.4	9.7
32.0	10.6	11.6	12.4	10.8	11.9	12.7	11.2	11.0	10.5		10.5	9.8	9.4	9.8	9.3
34.0	9.1	10.0	10.7	9.3	10.3	11.0	9.7	10.6	10.1		9.9	9.4	9.0	9.4	8.8
36.0	7.8	8.6	9.2	8.0	8.9	9.5	8.4	9.3	9.7		8.8	9.0	8.6	8.7	8.4
38.0	6.7	7.4	7.9	6.9	7.7	8.2	7.2	8.1	8.6		7.7	8.5	8.3	7.5	8.1
40.0	5.7	6.3	6.7	5.9	6.6	7.1	6.2	7.0	7.5		6.7	7.4	7.9	6.5	7.3
44.0	4.0	4.5	4.7	4.2	4.8	5.1	4.5	5.1	5.5		4.9	5.6	6.0	4.8	5.5
48.0	2.7	3.0		2.8	3.3	3.4	3.2	3.6	3.9		3.5	4.1	4.4	3.4	4.0
52.0				1.7	2.0		2.0	2.4	2.5		2.4	2.8	3.0	2.2	2.7
56.0												1.7	1.9		1.7

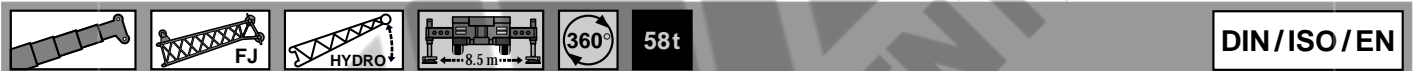

m	40.4 m + 19.5 m			45.4 m + 19.5 m			50.5 m + 19.5 m			55.6 m + 19.5 m			60.0 m + 19.5 m		
	0°	20°	40°	0°	20°	40°	0°	20°	40°	0°	20°	40°	0°	20°	40°
9.0	34.2														
10.0	32.8			29.9											
11.0	31.5			28.7			22.6								
12.0	30.3			27.3			21.5				18.8				
14.0	28.1			24.8			19.7				17.1			16.2	
16.0	26.3	20.6		22.8	19.2		18.1				15.8			14.9	
18.0	24.7	19.5		21.1	18.0		16.7	13.5			14.6	12.1		13.8	
20.0	23.0	18.6	16.0	19.6	17.0		15.5	12.8			13.6	11.4		12.9	10.8
22.0	21.4	17.8	15.4	18.3	16.0	14.6	14.4	12.2	10.6		12.7	10.8		12.1	10.3
24.0	19.4	17.1	14.9	17.2	15.1	13.8	13.5	11.6	10.2		12.0	10.2	9.1	11.3	9.7
26.0	17.0	16.4	14.5	16.2	14.3	13.2	12.7	11.1	9.8		11.2	9.7	8.7	10.6	9.3
28.0	14.9	15.8	14.0	14.6	13.6	12.6	11.9	10.6	9.4		10.6	9.3	8.4	10.0	8.8
30.0	12.9	14.6	13.6	12.9	13.0	12.1	11.3	10.2	9.1		10.0	8.9	8.1	9.4	8.4
32.0	11.1	12.7	13.3	11.1	12.4	11.6	10.7	9.7	8.8		9.4	8.5	7.8	8.9	8.1
34.0	9.7	11.1	12.3	9.7	11.2	11.2	10.0	9.3	8.5		8.9	8.1	7.5	8.4	7.7
36.0	8.4	9.7	10.7	8.4	9.7	10.8	8.7	8.9	8.3		8.5	7.8	7.2	8.0	7.4
38.0	7.2	8.4	9.3	7.2	8.5	9.4	7.6	8.5	8.0		7.8	7.5	7.0	7.6	7.1
40.0	6.2	7.3	8.0	6.2	7.3	8.2	6.6	7.7	7.7		6.8	7.2	6.8	6.6	6.8
44.0	4.5	5.4	5.9	4.5	5.4	6.1	4.8	5.8	6.5		5.0	6.0	6.4	4.9	5.9
48.0	3.1	3.8	4.1	3.1	3.9	4.3	3.4	4.2	4.8		3.6	4.5	5.1	3.5	4.3
52.0	2.0	2.5		2.0	2.6	2.9	2.3	2.9	3.3		2.5	3.2	3.6	2.3	3.0
56.0								1.8	2.1		1.5	2.1	2.4		2.0
60.0															2.4

Tragfähigkeiten
Lifting capacities
Capacités de levage
Capacidades de elevación

58t

DIN / ISO / EN

	40.4 m + 25.5 m			45.4 m + 25.5 m			50.5 m + 25.5 m			55.6 m + 25.5 m			60.0 m + 25.5 m		
	0°	20°	40°	0°	20°	40°	0°	20°	40°	0°	20°	40°	0°	20°	40°
10.0	27.8														
11.0	26.7														
12.0	25.7			23.6			19.5								
14.0	23.9			22.1			17.8			15.6			14.8		
16.0	22.2			20.7			16.3			14.3			13.6		
18.0	20.8	16.1		19.4			15.1			13.2			12.6		
20.0	19.6	15.3		18.1	14.4		14.1			12.3			11.7		
22.0	18.5	14.6		16.9	13.8		13.2	10.4		11.5	9.4		10.9		
24.0	17.5	13.9		15.8	13.2		12.3	9.9		10.8	8.9		10.2	8.5	
26.0	16.6	13.3	10.9	14.8	12.6	10.8	11.5	9.5		10.1	8.4		9.6	8.1	
28.0	15.0	12.8	10.6	14.0	12.2	10.5	10.9	9.0	7.9	9.5	8.0		9.1	7.7	
30.0	13.3	12.3	10.3	12.9	11.6	10.2	10.2	8.7	7.6	9.0	7.6	6.8	8.6	7.3	6.5
32.0	11.6	11.9	10.0	11.4	11.1	9.9	9.7	8.3	7.3	8.6	7.3	6.5	8.1	7.0	6.3
34.0	10.1	11.4	9.8	10.1	10.6	9.7	9.2	8.0	7.0	8.1	7.0	6.3	7.7	6.7	6.0
36.0	8.8	10.6	9.5	8.7	10.1	9.4	8.7	7.7	6.8	7.7	6.7	6.1	7.3	6.4	5.8
38.0	7.7	9.2	9.3	7.6	9.2	9.0	7.7	7.4	6.6	7.3	6.4	5.8	6.9	6.1	5.6
40.0	6.6	8.1	9.1	6.6	8.1	8.7	6.7	7.1	6.4	6.8	6.2	5.6	6.5	5.9	5.4
44.0	4.9	6.1	7.1	4.8	6.1	7.1	5.0	6.3	6.1	5.1	5.7	5.3	4.9	5.4	4.9
48.0	3.5	4.5	5.2	3.4	4.5	5.3	3.6	4.7	5.6	3.7	4.8	4.9	3.5	4.7	4.5
52.0	2.3	3.1	3.6	2.2	3.1	3.8	2.4	3.3	4.0	2.5	3.5	4.3	2.3	3.4	4.1
56.0		1.9	2.2		2.0	2.4		2.2	2.7		2.4	3.0		2.2	2.9
60.0									1.6			1.9			

58t

DIN / ISO / EN

	40.4 m + 31.5 m			45.4 m + 31.5 m			50.5 m + 31.5 m			55.6 m + 31.5 m			60.0 m + 31.5 m		
	0°	20°	40°	0°	20°	40°	0°	20°	40°	0°	20°	40°	0°	20°	40°
11.0	22.7														
12.0	21.9			20.2											
14.0	20.4			18.9			16.2								
16.0	19.0			17.7			14.8			13.6			12.0		
18.0	17.8			16.7			13.7			12.5			11.9		
20.0	16.7			15.7			12.7			11.6			11.0		
22.0	15.8	11.5		14.9			11.9			10.7			10.2		
24.0	14.9	10.9		14.1	10.8		11.1	8.7		10.0			9.6		
26.0	14.1	10.4		13.4	10.3		10.5	8.2		9.4	7.6		9.0		
28.0	13.4	10.0		12.7	9.9		9.9	7.9		8.8	7.2		8.4	6.9	
30.0	12.8	9.6	7.8	12.1	9.5		9.3	7.5		8.3	6.9		7.9	6.6	
32.0	11.7	9.2	7.5	11.3	9.1	7.5	8.8	7.2		7.9	6.6		7.5	6.3	
34.0	10.3	8.8	7.3	10.0	8.8	7.3	8.3	6.9	6.0	7.5	6.3		7.1	5.9	
36.0	9.0	8.5	7.1	8.8	8.5	7.1	7.9	6.6	5.7	7.1	6.0	5.3	6.7	5.5	4.7
38.0	7.8	8.2	6.9	7.7	8.2	6.9	7.5	6.3	5.5	6.7	5.7	5.1	6.4	5.2	4.4
40.0	6.8	7.9	6.8	6.7	7.9	6.7	6.8	6.1	5.4	6.4	5.5	4.9	5.9	4.9	4.2
44.0	5.1	6.6	6.4	4.9	6.6	6.4	5.0	5.7	5.0	5.2	5.0	4.6	4.8	4.3	3.8
48.0	3.6	5.0	6.1	3.5	4.9	6.1	3.6	5.0	4.7	3.9	4.7	4.2	3.5	3.9	3.4
52.0	2.5	3.6	4.4	2.3	3.5	4.5	2.4	3.7	4.5	2.7	4.0	3.9	2.4	3.4	3.1
56.0	1.5	2.4	3.0		2.4	3.1		2.5	3.3		2.8	3.6		2.7	2.8
60.0			1.8			1.9			2.2			2.5			2.4

Tragfähigkeiten
Lifting capacities
Capacités de levage
Capacidades de elevación

 m	40.4 m + 37.5 m			45.4 m + 37.5 m			50.5 m + 37.5 m			55.6 m + 37.5 m			60.0 m + 37.5 m		
	0°	20°	40°	0°	20°	40°	0°	20°	40°	0°	20°	40°	0°	20°	40°
12.0	18.3														
14.0	17.2			15.9											
16.0	16.2			15.1			13.5			11.0					
18.0	15.3			14.3			12.9			11.0			9.7		
20.0	14.5			13.6			12.1			10.7			9.7		
22.0	13.7			12.9			11.3			9.9			9.5		
24.0	12.8			12.3			10.5			9.2			8.8		
26.0	12.0	8.5		11.7	8.4		9.9			8.6			8.2		
28.0	11.3	8.1		11.1	8.1		9.3	7.2		8.1			7.7		
30.0	10.7	7.8		10.6	7.7		8.7	6.9		7.6	6.2		7.3		
32.0	10.1	7.5		10.1	7.4		8.3	6.6		7.2	5.9		6.9	5.4	
34.0	9.6	7.1		9.7	7.1		7.8	6.3		6.8	5.6		6.5	5.0	
36.0	9.1	6.9	5.6	8.8	6.8	5.5	7.4	6.0		6.4	5.3		6.1	4.7	
38.0	8.1	6.6	5.4	7.8	6.6	5.4	7.1	5.7	5.0	6.1	5.1		5.8	4.4	
40.0	7.1	6.3	5.3	6.9	6.3	5.2	6.7	5.5	4.8	5.8	4.9	4.3	5.3	4.1	
44.0	5.3	5.9	5.0	5.1	5.9	4.9	5.3	5.1	4.5	5.2	4.5	3.9	4.5	3.6	3.1
48.0	3.9	5.5	4.7	3.7	5.4	4.7	4.0	4.7	4.2	3.9	4.0	3.5	3.5	3.2	2.7
52.0	2.7	4.1	4.5	2.5	4.0	4.5	2.8	4.3	3.8	2.8	3.6	3.2		2.8	2.4
56.0	1.7	2.9	3.9		2.8	3.9		3.1	3.5		3.1	2.8		2.4	2.2
60.0		1.9	2.7		1.8	2.7		2.1	3.0			2.6			1.9
64.0			1.5												

 m	40.4 m + 43.5 m			45.4 m + 43.5 m			50.5 m + 43.5 m			55.6 m + 43.5 m			60.0 m + 43.5 m		
	0°	20°	40°	0°	20°	40°	0°	20°	40°	0°	20°	40°	0°	20°	40°
14.0	14.2														
16.0	13.4			12.3			10.9								
18.0	12.7			11.7			10.5			9.2					
20.0	12.0			11.1			10.0			8.9			8.2		
22.0	11.3			10.5			9.6			8.6			7.9		
24.0	10.6			10.0			9.2			8.2			7.7		
26.0	10.0			9.5			8.8			7.8			7.4		
28.0	9.3	6.5		9.1			8.3			7.3			6.9		
30.0	8.8	6.2		8.7	6.1		7.8			6.8			6.5		
32.0	8.3	5.9		8.3	5.8		7.3	5.7		6.4			6.1		
34.0	7.8	5.6		7.9	5.6		6.9	5.4		6.0	4.9		5.6		
36.0	7.4	5.4		7.5	5.3		6.5	5.2		5.7	4.6		5.1	3.7	
38.0	7.0	5.1		7.1	5.1		6.2	4.9		5.3	4.3		4.7	3.4	
40.0	6.6	4.9	3.9	6.6	4.9		5.9	4.7		5.0	4.0		4.3	3.1	
44.0	5.4	4.5	3.6	5.0	4.5	3.6	4.9	4.2	3.4	4.2	3.4		3.6	2.7	
48.0	4.0	4.1	3.4	3.7	4.2	3.4	3.6	3.7	3.0	3.5	3.0	2.5	2.9	2.3	1.9
52.0	2.7	3.8	3.2	2.6	3.9	3.2	2.5	3.3	2.7		2.5	2.1		1.9	1.6
56.0	1.7	3.2	2.9		3.1	3.0		2.9	2.4		2.2	1.8			
60.0		2.1	2.8			2.8			2.2			1.5			
64.0			2.1												

Tragfähigkeiten
Lifting capacities
Capacités de levage
Capacidades de elevación

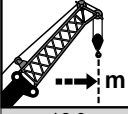

 m	40.4 m + 49.5 m			45.4 m + 49.5 m			50.5 m + 49.5 m			55.6 m + 49.5 m			60.0 m + 49.5 m		
	0°	20°	40°	0°	20°	40°	0°	20°	40°	0°	20°	40°	0°	20°	40°
16.0	10.7			9.8											
18.0	10.1			9.3			8.2								
20.0	9.6			8.8			7.8			6.8					
22.0	9.0			8.3			7.5			6.5			6.0		
24.0	8.5			7.9			7.1			6.3			5.8		
26.0	8.1			7.5			6.8			6.0			5.6		
28.0	7.6			7.1			6.5			5.8			5.4		
30.0	7.2			6.8			6.2			5.6			5.2		
32.0	6.7	4.6		6.5			5.9			5.3			4.9		
34.0	6.3	4.4		6.2	4.3		5.6			5.1			4.7		
36.0	6.0	4.1		5.9	4.1		5.4	4.0		4.9			4.2		
38.0	5.6	3.9		5.6	3.9		5.2	3.8		4.6	3.4		3.8	2.6	
40.0	5.3	3.7		5.3	3.7		4.9	3.6		4.2	3.1		3.5	2.3	
44.0	4.7	3.4		4.8	3.4		4.4	3.2		3.5	2.6		2.8	1.9	
48.0	3.9	3.0	2.2	3.5	3.0	2.2	3.4	2.8		2.8	2.1			1.5	
52.0	2.7	2.7	1.9		2.8	1.9		2.4	1.8		1.7				
56.0		2.4	1.7		2.5	1.7		2.0	1.5						
60.0		2.1	1.5			1.6									

WMA
SALE & RENTAL



UNIVERSAL
SALE & RENTAL

Hubhöhen
Lifting heights
Hauteurs de levage
Alturas de elevación







138t Heavy Duty
DIN/ISO/EN

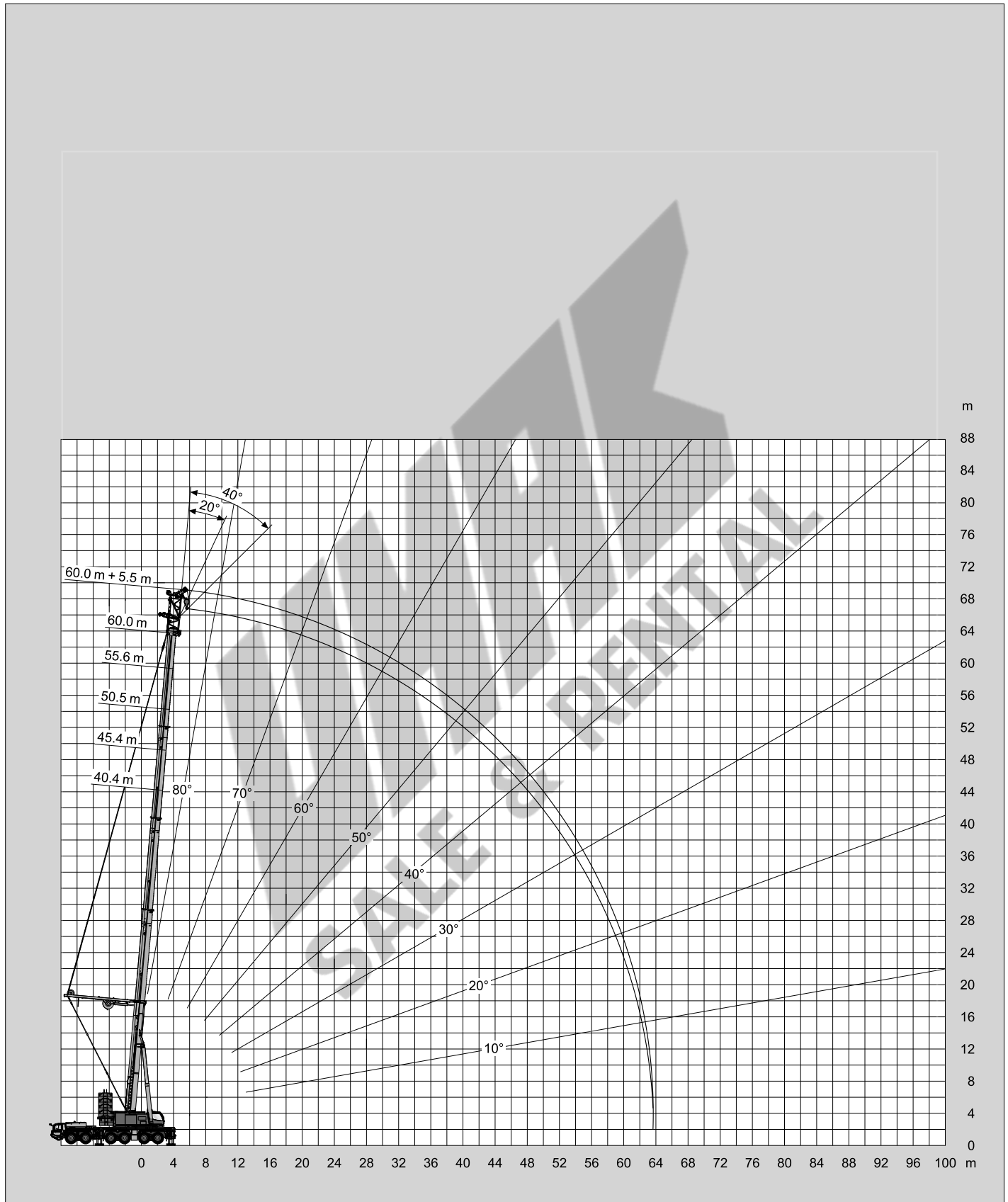

Tragfähigkeiten
Lifting capacities
Capacités de levage
Capacidades de elevación





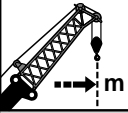

138t Heavy Duty
 DIN/ISO/EN

 m	40.4 m + 5.5 m			45.4 m + 5.5 m			50.5 m + 5.5 m			55.6 m + 5.5 m			60.0 m + 5.5 m		
	0°	20°	40°	0°	20°	40°	0°	20°	40°	0°	20°	40°	0°	20°	40°
7.0	58.6														
8.0	58.6	58.6		52.8											
9.0	58.6	58.6	55.0	52.8	55.8		36.6								
10.0	58.6	58.6	53.9	52.5	48.8	46.4	35.2	31.5			29.7				
11.0	58.6	57.7	52.9	51.2	47.7	45.5	34.0	30.6	28.4	28.6	26.2		27.2		
12.0	58.6	56.5	51.9	50.0	46.7	44.6	32.9	29.7	27.6	27.6	25.4	23.9	26.2	24.2	
14.0	56.8	54.2	50.2	47.8	44.8	42.9	30.9	28.1	26.3	25.8	23.8	22.6	24.6	22.8	21.6
16.0	50.2	48.4	47.2	45.9	43.2	41.5	29.2	26.7	25.1	24.2	22.5	21.4	23.1	21.5	20.5
18.0	44.8	43.4	42.5	42.5	41.1	40.3	27.7	25.4	24.1	22.8	21.3	20.3	21.8	20.4	19.5
20.0	40.3	39.2	38.6	38.3	37.2	36.5	26.3	24.3	23.2	21.5	20.2	19.4	20.6	19.4	18.6
22.0	36.5	35.7	35.2	34.7	33.8	33.3	25.1	23.4	22.3	20.4	19.3	18.5	19.6	18.5	17.8
24.0	33.3	32.7	32.3	31.6	30.9	30.6	24.1	22.5	21.6	19.5	18.4	17.8	18.7	17.7	17.1
26.0	30.6	30.1	29.8	29.0	28.4	28.2	23.1	21.7	20.9	18.6	17.6	17.1	17.8	16.9	16.4
28.0	28.2	27.7	27.6	26.7	26.3	26.0	22.3	21.0	20.3	17.8	16.9	16.5	16.8	16.3	15.8
30.0	26.0	25.7	25.6	24.7	24.3	24.2	21.5	20.3	19.7	17.1	16.3	15.9	15.6	15.2	14.9
32.0	24.2	23.9	23.8	22.9	22.6	22.5	20.8	19.7	19.2	16.4	15.7	15.3	14.5	14.1	13.9
34.0	22.5	22.3	22.3	21.3	21.1	21.0	20.2	19.2	18.8	15.8	15.2	14.9	13.5	13.2	13.0
36.0	21.0	20.9	20.9	19.8	19.7	19.6	19.4	18.7	18.4	15.3	14.7	14.4	12.6	12.3	12.2
38.0	19.6	19.5		18.6	18.4	18.4	18.1	18.0	17.9	14.8	14.3	14.0	11.8	11.6	11.5
40.0	18.4	18.4		17.4	17.3	17.3	17.0	16.8	16.8	14.3	13.9	13.7	11.0	10.9	10.8
44.0				15.3	15.3		15.0	14.9	14.9	13.5	13.2	13.1	9.7	9.6	9.6
48.0				8.9			13.4	13.3		12.9	12.6	12.6	8.7	8.6	8.6
52.0							9.5	9.7		11.7	11.7		7.6	7.7	7.7
56.0										9.5	9.6		6.6	6.6	
60.0													5.7	5.7	





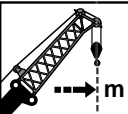

118t Heavy Duty
 DIN/ISO/EN

 m	40.4 m + 5.5 m			45.4 m + 5.5 m			50.5 m + 5.5 m			55.6 m + 5.5 m			60.0 m + 5.5 m		
	0°	20°	40°	0°	20°	40°	0°	20°	40°	0°	20°	40°	0°	20°	40°
7.0	58.6														
8.0	58.6	58.6		52.8											
9.0	58.6	58.6	55.0	52.8	55.8		36.6								
10.0	58.6	58.6	53.9	52.5	48.8	46.4	35.2	31.5			29.7				
11.0	58.6	57.7	52.9	51.2	47.7	45.5	34.0	30.6	28.4	28.6	26.2		27.2		
12.0	58.6	56.5	51.9	50.0	46.7	44.6	32.9	29.7	27.6	27.6	25.4	23.9	26.2	24.2	
14.0	56.8	54.2	50.2	47.8	44.8	42.9	30.9	28.1	26.3	25.8	23.8	22.6	24.6	22.8	21.6
16.0	50.2	48.4	47.2	45.9	43.2	41.5	29.2	26.7	25.1	24.2	22.5	21.4	23.1	21.5	20.5
18.0	44.8	43.4	42.5	42.5	41.1	40.3	27.7	25.4	24.1	22.8	21.3	20.3	21.8	20.4	19.5
20.0	40.3	39.2	38.6	38.3	37.2	36.5	26.3	24.3	23.2	21.5	20.2	19.4	20.6	19.4	18.6
22.0	36.5	35.7	35.2	34.7	33.8	33.3	25.1	23.4	22.3	20.4	19.3	18.5	19.6	18.5	17.8
24.0	33.3	32.7	32.3	31.6	30.9	30.6	24.1	22.5	21.6	19.5	18.4	17.8	18.7	17.7	17.1
26.0	30.6	30.1	29.8	29.0	28.4	28.2	23.1	21.7	20.9	18.6	17.6	17.1	17.8	16.9	16.4
28.0	28.2	27.7	27.6	26.7	26.3	26.0	22.3	21.0	20.3	17.8	16.9	16.5	16.8	16.3	15.8
30.0	26.0	25.7	25.6	24.7	24.3	24.2	21.5	20.3	19.7	17.1	16.3	15.9	15.6	15.2	14.9
32.0	23.2	23.5	23.6	22.9	22.6	22.5	20.8	19.7	19.2	16.4	15.7	15.3	14.5	14.1	13.9
34.0	20.8	21.0	21.0	21.2	21.1	21.0	20.2	19.2	18.8	15.8	15.2	14.9	13.5	13.2	13.0
36.0	18.6	18.8	18.8	19.1	19.3	19.4	19.4	18.7	18.4	15.3	14.7	14.4	12.6	12.3	12.2
38.0	16.7	16.8		17.2	17.4	17.4	17.9	18.0	17.9	14.8	14.3	14.0	11.8	11.6	11.5
40.0	15.0	15.1		15.5	15.6	15.7	16.2	16.4	16.5	14.3	13.9	13.7	11.0	10.9	10.8
44.0				12.6	12.7		13.3	13.5	13.5	13.5	13.2	13.1	9.7	9.6	9.6
48.0				8.9			11.0	11.1		11.6	11.7	11.7	8.7	8.6	8.6
52.0							9.0	9.0		9.6	9.7		7.6	7.7	7.7
56.0										7.9	8.0		6.6	6.6	
60.0													5.7	5.7	

MB + FJ + PS

Tragfähigkeiten
Lifting capacities
Capacités de levage
Capacidades de elevación

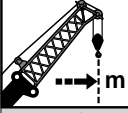

	40.4 m + 5.5 m			45.4 m + 5.5 m			50.5 m + 5.5 m			55.6 m + 5.5 m			60.0 m + 5.5 m		
	0°	20°	40°	0°	20°	40°	0°	20°	40°	0°	20°	40°	0°	20°	40°
7.0	58.6														
8.0	58.6	58.6		52.8											
9.0	58.6	58.6	55.0	52.8	55.8		36.6								
10.0	58.6	58.6	53.9	52.5	48.8	46.4	35.2	31.5			29.7				
11.0	58.6	57.7	52.9	51.2	47.7	45.5	34.0	30.6	28.4	29.7	28.6	26.2		27.2	
12.0	54.6	56.0	51.9	50.0	46.7	44.6	32.9	29.7	27.6	27.6	25.4	23.9	26.2	24.2	
14.0	44.5	45.7	46.6	43.6	44.7	42.9	30.9	28.1	26.3	25.8	23.8	22.6	24.6	22.8	21.6
16.0	37.0	37.9	38.7	36.4	37.3	38.1	29.2	26.7	25.1	24.2	22.5	21.4	23.1	21.5	20.5
18.0	31.1	32.0	32.6	30.8	31.6	32.2	27.7	25.4	24.1	22.8	21.3	20.3	21.8	20.4	19.5
20.0	26.4	27.1	27.6	26.2	26.9	27.4	26.3	24.3	23.2	21.5	20.2	19.4	20.6	19.4	18.6
22.0	22.4	23.1	23.4	22.4	23.0	23.5	22.6	23.2	22.3	20.4	19.3	18.5	19.6	18.5	17.8
24.0	18.8	19.3	19.6	19.3	19.8	20.2	19.6	20.1	20.5	19.5	18.4	17.8	18.7	17.7	17.1
26.0	15.7	16.2	16.4	16.2	16.7	17.0	17.0	17.4	17.8	17.2	17.6	17.1	16.9	16.9	16.4
28.0	13.2	13.6	13.8	13.7	14.1	14.4	14.5	14.9	15.2	15.1	15.5	15.8	14.8	15.2	15.5
30.0	11.1	11.4	11.6	11.6	11.9	12.1	12.4	12.8	13.0	13.1	13.5	13.7	12.9	13.3	13.6
32.0	9.3	9.5	9.6	9.8	10.1	10.2	10.5	10.9	11.1	11.2	11.6	11.8	11.3	11.7	11.9
34.0	7.7	7.9	8.0	8.2	8.4	8.6	9.0	9.3	9.4	9.6	9.9	10.1	9.8	10.1	10.3
36.0	6.3	6.5	6.5	6.8	7.0	7.1	7.6	7.8	7.9	8.3	8.5	8.7	8.4	8.7	8.8
38.0	5.1	5.2		5.6	5.8	5.8	6.4	6.6	6.7	7.0	7.3	7.4	7.2	7.4	7.5
40.0	4.0	4.1		4.5	4.7	4.7	5.3	5.5	5.5	5.9	6.1	6.2	6.1	6.3	6.4
44.0				2.7	2.8		3.4	3.6	3.6	4.1	4.2	4.3	4.2	4.4	4.5
48.0							1.9	2.0		2.6	2.7	2.7	2.7	2.8	2.9
52.0														1.5	1.5

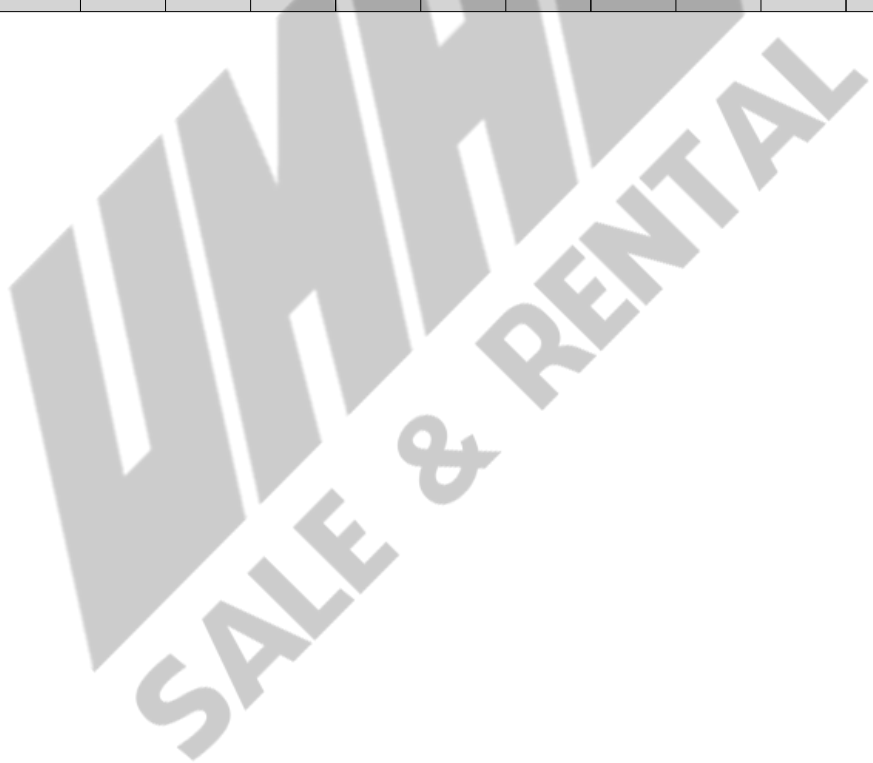



UNIVERSAL
SALE & RENTAL

Hubhöhen
Lifting heights
Hauteurs de levage
Alturas de elevación







138t
DIN/ISO/EN

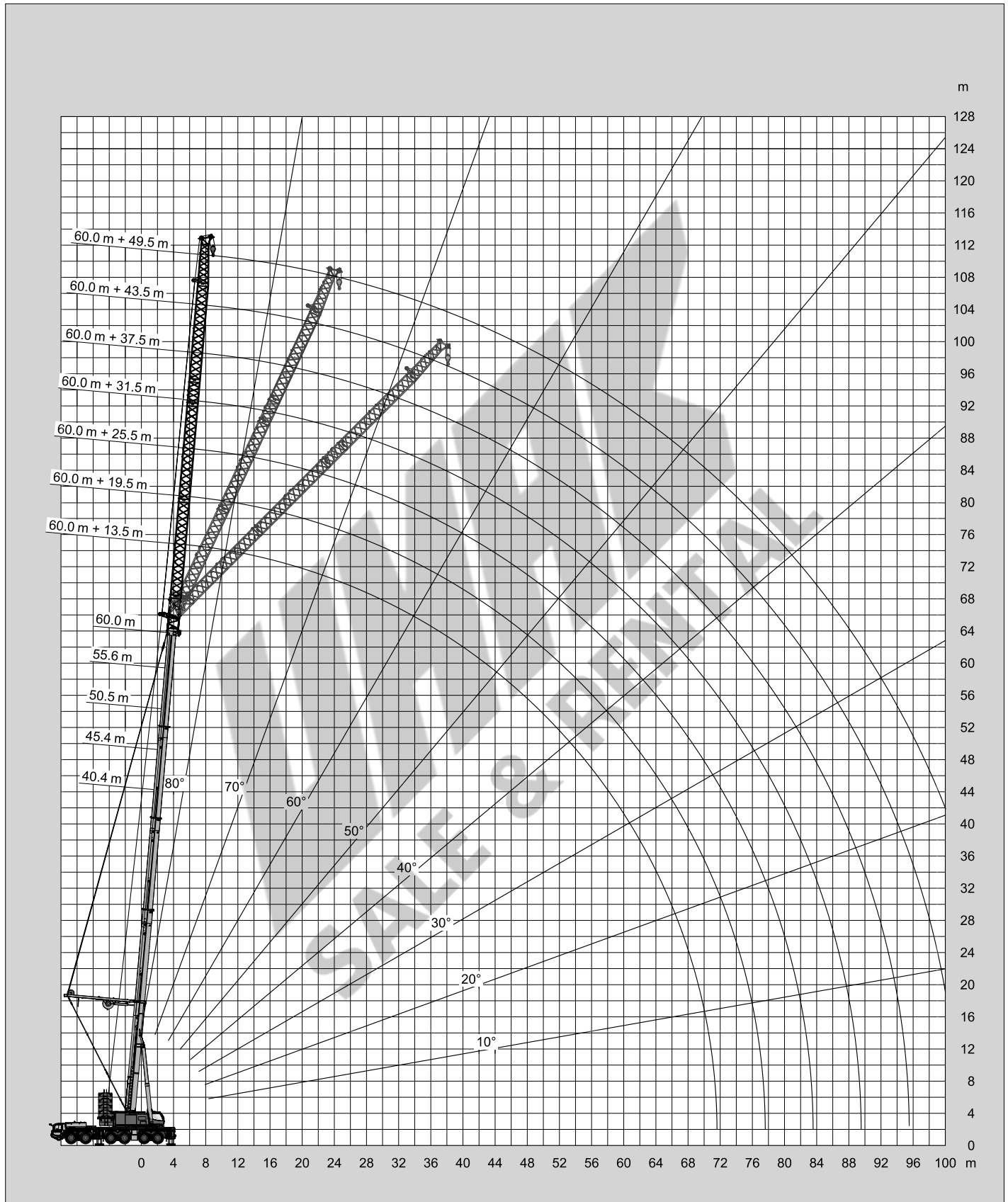

Tragfähigkeiten
Lifting capacities
Capacités de levage
Capacidades de elevación

m	40.4 m + 13.5 m			45.4 m + 13.5 m			50.5 m + 13.5 m			55.6 m + 13.5 m			60.0 m + 13.5 m		
	0°	20°	40°	0°	20°	40°	0°	20°	40°	0°	20°	40°	0°	20°	40°
8.0	45.4														
9.0	45.4			36.6											
10.0	45.4			36.6			29.5								
11.0	45.4			36.6			29.4				22.4				
12.0	44.8	33.7		36.6			28.2				22.4			19.5	
14.0	42.2	32.1		36.6	30.8		26.1	20.3			22.4			19.5	
16.0	39.8	30.6	25.7	36.6	29.6	24.9	24.2	19.2			20.9	17.1		19.5	16.4
18.0	37.6	29.3	24.9	36.1	28.4	24.2	22.7	18.2	15.6		19.5	16.2	14.2	18.6	15.5
20.0	35.3	28.1	24.1	33.9	27.4	23.5	21.3	17.3	15.0		18.3	15.3	13.6	17.5	14.7
22.0	32.0	27.1	23.4	30.6	26.4	22.8	20.1	16.5	14.5		17.2	14.6	13.0	16.5	14.0
24.0	29.2	26.1	22.8	27.9	25.6	22.3	19.0	15.8	14.0		16.2	13.9	12.5	15.6	13.4
26.0	26.7	25.3	22.3	25.5	24.1	21.8	18.1	15.2	13.5		15.4	13.3	12.0	14.8	12.8
28.0	24.6	23.5	21.8	23.5	22.3	21.3	17.2	14.6	13.1		14.6	12.7	11.5	14.0	12.2
30.0	22.7	21.8	21.3	21.7	20.7	20.2	16.4	14.0	12.7		13.9	12.2	11.1	13.1	11.7
32.0	21.1	20.3	19.3	20.1	19.3	18.9	15.8	13.6	12.3		13.3	11.7	10.8	12.1	11.2
34.0	19.6	19.0	18.7	18.6	18.0	17.6	15.1	13.1	12.0		12.7	11.2	10.4	11.2	10.5
36.0	18.3	17.8	17.5	17.4	16.8	16.5	14.5	12.7	11.7		12.1	10.8	10.1	10.4	9.8
38.0	17.1	16.7	16.5	16.2	15.8	15.6	14.0	12.3	11.4		11.6	10.5	9.8	9.7	9.2
40.0	16.0	15.7	15.5	15.1	14.8	14.6	13.5	12.0	11.2		11.2	10.1	9.5	9.0	8.6
44.0	14.1	13.9	13.9	13.3	13.1	13.0	12.7	11.4	10.7		10.4	9.5	9.0	7.9	7.6
48.0	12.5	12.4		11.8	11.6	11.6	11.5	10.9	10.4		9.7	9.0	8.6	6.9	6.7
52.0				10.5	10.4		10.2	10.1	10.1		9.2	8.5	8.2	6.1	6.0
56.0				5.7			9.1	9.0			8.7	8.2	8.0	5.4	5.3
60.0							6.4	7.6			7.9	7.9		4.8	4.7
64.0											6.5	7.1		4.3	4.3
68.0														3.8	3.8

m	40.4 m + 19.5 m			45.4 m + 19.5 m			50.5 m + 19.5 m			55.6 m + 19.5 m			60.0 m + 19.5 m		
	0°	20°	40°	0°	20°	40°	0°	20°	40°	0°	20°	40°	0°	20°	40°
9.0	32.6														
10.0	32.6			28.2											
11.0	32.6			28.2			21.6								
12.0	32.6			28.2			21.6				16.7				
14.0	32.6			28.2			21.6				16.7			14.5	
16.0	31.2	23.3		28.2	22.3		21.3				16.7			14.4	
18.0	29.4	22.2		28.1	21.4		19.8	15.0			16.7	13.6		14.0	
20.0	27.9	21.3	17.7	26.9	20.6		18.5	14.3			16.0	12.8		13.6	12.4
22.0	26.5	20.4	17.1	25.6	19.8	16.7	17.4	13.6	11.5		15.0	12.2		13.1	11.8
24.0	25.2	19.6	16.6	24.5	19.1	16.2	16.4	13.0	11.1		14.1	11.6	10.1	12.7	11.2
26.0	24.0	18.9	16.2	23.2	18.5	15.8	15.5	12.4	10.7		13.4	11.0	9.7	12.1	10.7
28.0	22.4	18.2	15.8	21.3	17.9	15.4	14.7	11.9	10.3		12.6	10.5	9.3	11.6	10.2
30.0	20.7	17.7	15.4	19.7	17.4	15.1	14.0	11.4	10.0		12.0	10.1	9.0	11.1	9.8
32.0	19.2	17.1	15.0	18.2	16.9	14.7	13.3	11.0	9.7		11.4	9.7	8.7	10.6	9.4
34.0	17.8	16.6	14.7	16.9	16.1	14.4	12.7	10.6	9.4		10.9	9.3	8.4	9.8	9.0
36.0	16.6	16.0	14.5	15.8	15.1	14.2	12.2	10.2	9.2		10.4	8.9	8.1	9.1	8.4
38.0	15.5	15.0	14.2	14.7	14.2	13.9	11.7	9.9	8.9		9.9	8.6	7.8	8.4	7.8
40.0	14.5	14.1	13.9	13.7	13.3	13.1	11.2	9.6	8.7		9.5	8.3	7.6	7.8	7.3
44.0	12.8	12.5	12.5	12.0	11.8	11.6	10.4	9.0	8.3		8.8	7.7	7.2	6.7	6.4
48.0	11.3	11.2	11.1	10.6	10.4	10.4	9.8	8.6	8.0		8.1	7.3	6.8	5.9	5.6
52.0	10.1	10.0		9.4	9.3	9.3	9.1	8.2	7.7		7.6	6.9	6.5	5.1	5.0
56.0	7.7	9.0		8.4	8.3		8.1	7.9	7.5		7.1	6.5	6.2	4.5	4.4
60.0				7.4	7.4		7.2	7.2	7.2		6.7	6.2	6.0	3.9	3.9
64.0							6.5	6.4			6.2	6.0	5.8	3.4	3.4
68.0											5.5	5.5		3.0	3.0
72.0											2.3	3.7		2.6	2.7
76.0														2.0	2.4

MB + FJ + PS

Tragfähigkeiten
Lifting capacities
Capacités de levage
Capacidades de elevación



Lift Height (m)	40.4 m + 25.5 m			45.4 m + 25.5 m			50.5 m + 25.5 m			55.6 m + 25.5 m			60.0 m + 25.5 m		
	0°	20°	40°	0°	20°	40°	0°	20°	40°	0°	20°	40°	0°	20°	40°
10.0	24.7														
11.0	24.7														
12.0	24.7			21.4			16.6								
14.0	24.7			21.4			16.6			12.6			10.8		
16.0	24.7			21.4			16.6			12.6			10.8		
18.0	24.3	17.0		21.4			16.6			12.6			10.4		
20.0	23.0	16.2		21.4	16.2		16.3			12.6			10.0		
22.0	21.7	15.5		21.1	15.5		15.2	11.5		12.6	10.5		9.6		
24.0	20.6	14.8		20.1	14.8		14.3	10.9		12.6	9.9		9.2	9.6	
26.0	19.6	14.1	11.3	19.2	14.3	11.3	13.5	10.4		11.8	9.4		8.8	9.1	
28.0	18.7	13.6	11.0	18.4	13.7	11.0	12.7	10.0	8.5	11.1	9.0		8.3	8.7	
30.0	17.7	13.1	10.7	17.7	13.2	10.7	12.1	9.6	8.2	10.5	8.6	7.5	7.9	8.2	6.9
32.0	16.8	12.6	10.4	16.7	12.8	10.5	11.5	9.2	7.9	10.0	8.2	7.2	7.4	7.7	6.5
34.0	15.9	12.1	10.2	15.5	12.3	10.2	10.9	8.8	7.6	9.5	7.9	6.9	7.0	7.3	6.2
36.0	15.2	11.7	9.9	14.4	11.9	10.0	10.4	8.5	7.4	9.0	7.6	6.7	6.6	6.8	5.9
38.0	14.2	11.3	9.7	13.4	11.6	9.8	10.0	8.2	7.2	8.6	7.3	6.5	6.1	6.5	5.7
40.0	13.3	11.0	9.5	12.5	11.2	9.6	9.6	7.9	7.0	8.2	7.0	6.3	5.8	6.1	5.4
44.0	11.7	10.4	9.2	11.0	10.6	9.3	8.8	7.4	6.6	7.5	6.5	5.9	5.0	5.5	4.9
48.0	10.3	9.9	9.0	9.6	9.4	9.0	8.2	7.0	6.3	6.9	6.0	5.5	4.4	4.8	4.5
52.0	9.2	9.0	8.8	8.5	8.4	8.4	7.6	6.6	6.1	6.4	5.7	5.2	3.8	4.1	4.1
56.0	8.2	8.1	8.1	7.5	7.5	7.5	7.2	6.3	5.8	6.0	5.3	4.9	3.2	3.6	3.6
60.0	7.3	7.3		6.7	6.6	6.7	6.4	6.0	5.7	5.5	4.9	4.6	2.8	3.1	3.2
64.0				5.9	5.9		5.6	5.6	5.6	5.1	4.6	4.4	2.3	2.7	2.8
68.0				2.8			5.0	5.0		4.8	4.3	4.2	2.0	2.3	2.4
72.0							3.3	4.4		4.2	4.1		1.6	2.0	2.1
76.0										3.5	3.7			1.7	



Lift Height (m)	40.4 m + 31.5 m			45.4 m + 31.5 m			50.5 m + 31.5 m			55.6 m + 31.5 m			60.0 m + 31.5 m		
	0°	20°	40°	0°	20°	40°	0°	20°	40°	0°	20°	40°	0°	20°	40°
11.0	18.6														
12.0	18.6			16.1											
14.0	18.6			16.1			12.4								
16.0	18.6			16.1			12.4			8.6			7.3		
18.0	18.6			16.1			12.4			8.6			7.0		
20.0	18.6			16.1			12.4			8.6			6.7		
22.0	17.8	12.1		16.1			12.4			8.6			6.3		
24.0	16.7	11.5		16.1	11.5		12.4	9.4		8.6			6.0		
26.0	15.7	11.0		15.7	11.0		11.9	9.0		8.6	8.5		5.6		
28.0	14.8	10.5		15.1	10.6		11.2	8.6		8.4	8.1		5.3	7.2	
30.0	14.0	10.1	8.1	14.4	10.2		10.6	8.2		8.3	7.7		4.9	6.7	
32.0	13.2	9.7	7.8	13.7	9.8	7.8	10.1	7.9		8.1	7.3		4.6	6.3	
34.0	12.5	9.3	7.6	13.0	9.4	7.6	9.6	7.5	6.4	7.9	7.0		4.2	5.9	
36.0	11.9	9.0	7.4	12.4	9.1	7.4	9.1	7.2	6.2	7.7	6.7	5.8	3.9	5.5	4.7
38.0	11.4	8.7	7.2	11.8	8.8	7.2	8.7	7.0	6.0	7.5	6.4	5.6	3.5	5.2	4.4
40.0	10.9	8.4	7.0	11.3	8.5	7.1	8.3	6.7	5.8	7.3	6.2	5.4	3.2	4.9	4.2
44.0	9.9	7.8	6.7	9.9	8.0	6.8	7.6	6.2	5.4	6.8	5.7	5.0	2.6	4.3	3.8
48.0	9.2	7.4	6.5	8.7	7.5	6.5	7.0	5.8	5.1	6.2	5.2	4.6	2.1	3.9	3.4
52.0	8.3	7.0	6.3	7.6	7.2	6.3	6.5	5.5	4.9	5.6	4.7	4.2	1.6	3.4	3.1
56.0	7.3	6.7	6.1	6.7	6.7	6.1	6.0	5.1	4.6	5.0	4.3	3.9		3.0	2.8
60.0	6.5	6.4	6.1	5.9	5.9	5.9	5.6	4.8	4.4	4.6	3.9	3.6		2.5	2.5
64.0	5.8	5.8	5.8	5.2	5.2	5.2	4.9	4.5	4.2	4.1	3.6	3.3		2.1	2.2
68.0	4.1	5.1		4.6	4.6	4.6	4.3	4.3	4.0	3.8	3.3	3.1		1.8	1.9
72.0				4.0	4.0		3.7	3.8	3.8	3.3	3.1	2.9			1.6
76.0							3.2	3.3		2.9	2.8	2.8			
80.0										2.5	2.6				

Tragfähigkeiten
Lifting capacities
Capacités de levage
Capacidades de elevación



m	40.4 m + 37.5 m			45.4 m + 37.5 m			50.5 m + 37.5 m			55.6 m + 37.5 m			60.0 m + 37.5 m		
	0°	20°	40°	0°	20°	40°	0°	20°	40°	0°	20°	40°	0°	20°	40°
12.0	14.1														
14.0	14.1			12.2											
16.0	14.1			12.2			8.8			6.0					
18.0	14.1			12.2			8.8			6.0			4.7		
20.0	14.1			12.2			8.8			6.0			4.4		
22.0	14.1			12.2			8.8			6.0			4.2		
24.0	13.9			12.2			8.8			6.0			3.8		
26.0	13.0	9.0		12.2	9.0		8.8			6.0			3.5		
28.0	12.2	8.6		12.2	8.6		8.8	7.8		5.8			3.2		
30.0	11.6	8.2		11.8	8.2		8.8	7.5		5.7	6.9		2.9		
32.0	10.9	7.8		11.2	7.9		8.8	7.1		5.5	6.5		2.6	5.4	
34.0	10.3	7.5		10.6	7.6		8.8	6.8		5.3	6.2		2.2	5.0	
36.0	9.8	7.2	5.8	10.1	7.3	5.8	8.4	6.5		5.2	5.9		1.9	4.7	
38.0	9.3	6.9	5.6	9.7	7.0	5.6	8.0	6.3	5.3	5.0	5.7		1.6	4.4	
40.0	8.9	6.7	5.5	9.2	6.8	5.5	7.6	6.0	5.1	4.8	5.4	4.6		4.1	
44.0	8.1	6.2	5.2	8.4	6.3	5.2	6.9	5.6	4.7	4.3	4.9	4.2		3.6	3.1
48.0	7.4	5.8	4.9	7.7	5.9	4.9	6.3	5.2	4.4	3.9	4.3	3.8		3.2	2.7
52.0	6.8	5.5	4.7	7.0	5.6	4.7	5.8	4.7	4.0	3.4	3.9	3.4		2.8	2.4
56.0	6.3	5.2	4.5	6.1	5.3	4.6	5.4	4.4	3.7	3.0	3.5	3.1		2.4	2.2
60.0	5.9	4.9	4.4	5.4	5.0	4.4	4.9	4.0	3.5	2.5	3.1	2.8		2.1	1.9
64.0	5.3	4.7	4.3	4.7	4.7	4.3	4.5	3.7	3.3	2.1	2.8	2.5		1.6	1.7
68.0	4.7	4.5	4.3	4.1	4.1	4.2	3.9	3.4	3.1	1.6	2.5	2.3			1.5
72.0	4.1	4.1		3.6	3.6	3.7	3.3	3.2	2.9		2.3	2.1			
76.0				3.1	3.1		2.9	2.9	2.8		2.1	1.9			
80.0							2.4	2.5	2.5		1.9	1.8			
84.0								2.1	2.1		1.7	1.7			



m	40.4 m + 43.5 m			45.4 m + 43.5 m			50.5 m + 43.5 m			55.6 m + 43.5 m			60.0 m + 43.5 m		
	0°	20°	40°	0°	20°	40°	0°	20°	40°	0°	20°	40°	0°	20°	40°
14.0	10.1														
16.0	10.1			8.6			5.9								
18.0	10.1			8.6			5.9			3.5					
20.0	10.1			8.6			5.9			3.5			2.2		
22.0	10.1			8.6			5.9			3.5			1.9		
24.0	10.1			8.6			5.9			3.5			1.6		
26.0	10.1			8.6			5.9			3.4					
28.0	10.1	6.9		8.6			5.9			3.2					
30.0	9.5	6.5		8.6	6.5		5.9			3.1					
32.0	9.0	6.2		8.6	6.2		5.9	6.1		2.9					
34.0	8.4	5.9		8.6	5.9		5.9	5.9		2.8	4.8				
36.0	8.0	5.7		8.2	5.7		5.9	5.6		2.6	4.8			3.1	
38.0	7.6	5.4		7.8	5.5		5.9	5.3		2.4	4.6			3.1	
40.0	7.2	5.2	4.0	7.4	5.2		5.9	5.0		2.2	4.3			3.1	
44.0	6.5	4.8	3.7	6.7	4.8	3.7	5.9	4.4	3.5	1.8	3.7			2.7	
48.0	5.9	4.4	3.5	6.1	4.5	3.5	5.3	4.0	3.2		3.2	2.7		2.3	1.9
52.0	5.3	4.1	3.2	5.6	4.2	3.3	4.7	3.5	2.8		2.8	2.3		1.9	1.6
56.0	4.9	3.8	3.0	5.1	3.9	3.1	4.1	3.2	2.6		2.4	2.0		1.6	
60.0	4.5	3.5	2.9	4.6	3.6	2.9	3.7	2.8	2.3		2.1	1.7			
64.0	4.1	3.2	2.7	3.9	3.3	2.8	3.3	2.5	2.1		1.8	1.5			
68.0	3.8	3.0	2.6	3.3	3.1	2.6	2.9	2.3	1.9		1.5				
72.0	3.3	2.8	2.6	2.8	2.9	2.5	2.5	2.0	1.7						
76.0	2.9	2.7	2.6	2.3	2.4	2.5	2.0	1.8	1.6						
80.0	1.8	2.5		1.9	2.0	2.0	1.6	1.6	1.5						
84.0				1.6	1.6										

MB + FJ + PS

Tragfähigkeiten
Lifting capacities
Capacités de levage
Capacidades de elevación



	40.4 m + 49.5 m			45.4 m + 49.5 m			50.5 m + 49.5 m			55.6 m + 49.5 m					
	0°	20°	40°	0°	20°	40°	0°	20°	40°	0°	20°	40°			
16.0	6.7			5.5											
18.0	6.7			5.5			3.2								
20.0	6.7			5.5			3.2								
22.0	6.7			5.5			3.2								
24.0	6.7			5.5			3.2								
26.0	6.7			5.5			3.2								
28.0	6.7			5.5			3.2								
30.0	6.7			5.5			3.2								
32.0	6.7	4.8		5.5			3.2								
34.0	6.6	4.5		5.5	4.4		3.2								
36.0	6.2	4.3		5.5	4.2		3.2	4.1							
38.0	5.8	4.1		5.5	4.0		3.2	3.9			2.3				
40.0	5.5	3.9		5.5	3.8		3.2	3.7			2.3				
44.0	4.9	3.5		5.0	3.5		3.2	3.4			2.3				
48.0	4.4	3.1	2.2	4.6	3.2	2.2	3.2	3.0			2.3				
52.0	4.0	2.8	2.0	4.1	2.9	2.0	3.2	2.6	1.9		2.0	1.5			
56.0	3.6	2.5	1.8	3.8	2.6	1.8	3.2	2.2	1.6		1.6				
60.0	3.3	2.2	1.6	3.4	2.3	1.6	2.7	1.9							
64.0	2.9	2.0	1.5	3.1	2.1	1.5	2.3	1.6							
68.0	2.5	1.8		2.7	1.9		2.0								
72.0	2.3	1.6		2.2	1.7		1.7								
76.0	2.0			1.7	1.5										
80.0	1.8														
84.0	1.5														



Tragfähigkeiten
Lifting capacities
Capacités de levage
Capacidades de elevación



m	40.4 m + 13.5 m			45.4 m + 13.5 m			50.5 m + 13.5 m			55.6 m + 13.5 m			60.0 m + 13.5 m		
	0°	20°	40°	0°	20°	40°	0°	20°	40°	0°	20°	40°	0°	20°	40°
8.0	45.4														
9.0	45.4			36.6											
10.0	45.4			36.6			29.5								
11.0	45.4			36.6			29.4			22.4					
12.0	44.8	33.7		36.6			28.2			22.4			19.5		
14.0	42.2	32.1		36.6	30.8		26.1	20.3		22.4			19.5		
16.0	39.8	30.6	25.7	36.6	29.6	24.9	24.2	19.2		20.9	17.1		19.5	16.4	
18.0	37.6	29.3	24.9	36.1	28.4	24.2	22.7	18.2	15.6	19.5	16.2	14.2	18.6	15.5	
20.0	35.3	28.1	24.1	33.9	27.4	23.5	21.3	17.3	15.0	18.3	15.3	13.6	17.5	14.7	13.1
22.0	32.0	27.1	23.4	30.6	26.4	22.8	20.1	16.5	14.5	17.2	14.6	13.0	16.5	14.0	12.5
24.0	29.2	26.1	22.8	27.9	25.6	22.3	19.0	15.8	14.0	16.2	13.9	12.5	15.6	13.4	12.0
26.0	26.7	25.3	22.3	25.5	24.1	21.8	18.1	15.2	13.5	15.4	13.3	12.0	14.8	12.8	11.6
28.0	24.6	23.5	21.8	23.5	22.3	21.3	17.2	14.6	13.1	14.6	12.7	11.5	14.0	12.2	11.1
30.0	22.7	21.8	21.3	21.7	20.7	20.2	16.4	14.0	12.7	13.9	12.2	11.1	13.1	11.7	10.7
32.0	21.1	20.3	19.9	20.1	19.3	18.9	15.8	13.6	12.3	13.3	11.7	10.8	12.1	11.2	10.4
34.0	19.6	19.0	18.7	18.6	18.0	17.6	15.1	13.1	12.0	12.7	11.2	10.4	11.2	10.5	10.0
36.0	18.3	17.8	17.5	17.4	16.8	16.5	14.5	12.7	11.7	12.1	10.8	10.1	10.4	9.8	9.5
38.0	17.1	16.7	16.5	16.2	15.8	15.6	14.0	12.3	11.4	11.6	10.5	9.8	9.7	9.2	8.9
40.0	16.0	15.7	15.5	15.1	14.8	14.6	13.5	12.0	11.2	11.2	10.1	9.5	9.0	8.6	8.4
44.0	13.3	13.8	13.9	13.3	13.1	13.0	12.7	11.4	10.7	10.4	9.5	9.0	7.9	7.6	7.4
48.0	10.9	11.3		11.2	11.6	11.6	11.5	10.9	10.4	9.7	9.0	8.6	6.9	6.7	6.6
52.0				9.2	9.5		9.6	10.1	10.1	9.2	8.5	8.2	6.1	6.0	5.9
56.0				5.7			8.0	8.3		8.4	8.2	8.0	5.4	5.3	5.3
60.0							6.4	6.7		7.0	7.2		4.8	4.7	4.8
64.0										5.7	5.9		4.3	4.3	
68.0													3.8	3.8	



m	40.4 m + 19.5 m			45.4 m + 19.5 m			50.5 m + 19.5 m			55.6 m + 19.5 m			60.0 m + 19.5 m		
	0°	20°	40°	0°	20°	40°	0°	20°	40°	0°	20°	40°	0°	20°	40°
9.0	32.6														
10.0	32.6			28.2											
11.0	32.6			28.2			21.6								
12.0	32.6			28.2			21.6			16.7					
14.0	32.6			28.2			21.6			16.7			14.5		
16.0	31.2	23.3		28.2	22.3		21.3			16.7			14.4		
18.0	29.4	22.2		28.1	21.4		19.8	15.0		16.7	13.6		14.0		
20.0	27.9	21.3	17.7	26.9	20.6		18.5	14.3		16.0	12.8		13.6	12.4	
22.0	26.5	20.4	17.1	25.6	19.8	16.7	17.4	13.6	11.5	15.0	12.2		13.1	11.8	
24.0	25.2	19.6	16.6	24.5	19.1	16.2	16.4	13.0	11.1	14.1	11.6	10.1	12.7	11.2	
26.0	24.0	18.9	16.2	23.2	18.5	15.8	15.5	12.4	10.7	13.4	11.0	9.7	12.1	10.7	9.4
28.0	22.4	18.2	15.8	21.3	17.9	15.4	14.7	11.9	10.3	12.6	10.5	9.3	11.6	10.2	9.0
30.0	20.7	17.7	15.4	19.7	17.4	15.1	14.0	11.4	10.0	12.0	10.1	9.0	11.1	9.8	8.7
32.0	19.2	17.1	15.0	18.2	16.9	14.7	13.3	11.0	9.7	11.4	9.7	8.7	10.6	9.4	8.4
34.0	17.8	16.6	14.7	16.9	16.1	14.4	12.7	10.6	9.4	10.9	9.3	8.4	9.8	9.0	8.0
36.0	16.6	16.0	14.5	15.8	15.1	14.2	12.2	10.2	9.2	10.4	8.9	8.1	9.1	8.4	7.6
38.0	15.5	15.0	14.2	14.7	14.2	13.9	11.7	9.9	8.9	9.9	8.6	7.8	8.4	7.8	7.3
40.0	14.5	14.1	13.9	13.7	13.3	13.1	11.2	9.6	8.7	9.5	8.3	7.6	7.8	7.3	7.0
44.0	12.8	12.5	12.5	12.0	11.8	11.6	10.4	9.0	8.3	8.8	7.7	7.2	6.7	6.4	6.3
48.0	11.3	11.2	11.1	10.6	10.4	10.4	9.8	8.6	8.0	8.1	7.3	6.8	5.9	5.6	5.6
52.0	9.6	10.0		9.4	9.3	9.3	9.1	8.2	7.7	7.6	6.9	6.5	5.1	5.0	5.0
56.0	7.7	8.2		8.0	8.3		8.1	7.9	7.5	7.1	6.5	6.2	4.5	4.4	4.4
60.0				6.6	6.9		6.9	7.2	7.2	6.7	6.2	6.0	3.9	3.9	3.9
64.0							5.7	6.0		5.9	6.0	5.8	3.4	3.4	3.5
68.0										4.8	5.1		3.0	3.0	3.1
72.0										2.3	3.7		2.6	2.7	
76.0													2.0	2.4	

MB + FJ + PS

Tragfähigkeiten
Lifting capacities
Capacités de levage
Capacidades de elevación



m	40.4 m + 25.5 m			45.4 m + 25.5 m			50.5 m + 25.5 m			55.6 m + 25.5 m			60.0 m + 25.5 m		
	0°	20°	40°	0°	20°	40°	0°	20°	40°	0°	20°	40°	0°	20°	40°
10.0	24.7														
11.0	24.7														
12.0	24.7			21.4			16.6								
14.0	24.7			21.4			16.6			12.6			10.8		
16.0	24.7			21.4			16.6			12.6			10.8		
18.0	24.3	17.0		21.4			16.6			12.6			10.4		
20.0	23.0	16.2		21.4	16.2		16.3			12.6			10.0		
22.0	21.7	15.5		21.1	15.5		15.2	11.5		12.6	10.5		9.6		
24.0	20.6	14.8		20.1	14.8		14.3	10.9		12.6	9.9		9.2	9.6	
26.0	19.6	14.1	11.3	19.2	14.3	11.3	13.5	10.4		11.8	9.4		8.8	9.1	
28.0	18.7	13.6	11.0	18.4	13.7	11.0	12.7	10.0	8.5	11.1	9.0		8.3	8.7	
30.0	17.7	13.1	10.7	17.7	13.2	10.7	12.1	9.6	8.2	10.5	8.6	7.5	7.9	8.2	6.9
32.0	16.8	12.6	10.4	16.7	12.8	10.5	11.5	9.2	7.9	10.0	8.2	7.2	7.4	7.7	6.5
34.0	15.9	12.1	10.2	15.5	12.3	10.2	10.9	8.8	7.6	9.5	7.9	6.9	7.0	7.3	6.2
36.0	15.2	11.7	9.9	14.4	11.9	10.0	10.4	8.5	7.4	9.0	7.6	6.7	6.6	6.8	5.9
38.0	14.2	11.3	9.7	13.4	11.6	9.8	10.0	8.2	7.2	8.6	7.3	6.5	6.1	6.5	5.7
40.0	13.3	11.0	9.5	12.5	11.2	9.6	9.6	7.9	7.0	8.2	7.0	6.3	5.8	6.1	5.4
44.0	11.7	10.4	9.2	11.0	10.6	9.3	8.8	7.4	6.6	7.5	6.5	5.9	5.0	5.5	4.9
48.0	10.3	9.9	9.0	9.6	9.4	9.0	8.2	7.0	6.3	6.9	6.0	5.5	4.4	4.8	4.5
52.0	9.2	9.0	8.8	8.5	8.4	8.4	7.6	6.6	6.1	6.4	5.7	5.2	3.8	4.1	4.1
56.0	8.2	8.1	8.1	7.5	7.5	7.5	7.2	6.3	5.8	6.0	5.3	4.9	3.2	3.6	3.6
60.0	7.0	7.3		6.7	6.6	6.7	6.4	6.0	5.7	5.5	4.9	4.6	2.8	3.1	3.2
64.0				5.7	5.9		5.6	5.6	5.6	5.1	4.6	4.4	2.3	2.7	2.8
68.0				2.8			4.8	5.0		4.8	4.3	4.2	2.0	2.3	2.4
72.0							3.3	4.1		4.0	4.1		1.6	2.0	2.1
76.0										3.2	3.4			1.7	



m	40.4 m + 31.5 m			45.4 m + 31.5 m			50.5 m + 31.5 m			55.6 m + 31.5 m			60.0 m + 31.5 m		
	0°	20°	40°	0°	20°	40°	0°	20°	40°	0°	20°	40°	0°	20°	40°
11.0	18.6														
12.0	18.6			16.1											
14.0	18.6			16.1			12.4								
16.0	18.6			16.1			12.4			8.6			7.3		
18.0	18.6			16.1			12.4			8.6			7.0		
20.0	18.6			16.1			12.4			8.6			6.7		
22.0	17.8	12.1		16.1			12.4			8.6			6.3		
24.0	16.7	11.5		16.1	11.5		12.4	9.4		8.6			6.0		
26.0	15.7	11.0		15.7	11.0		11.9	9.0		8.6	8.5		5.6		
28.0	14.8	10.5		15.1	10.6		11.2	8.6		8.4	8.1		5.3	7.2	
30.0	14.0	10.1	8.1	14.4	10.2		10.6	8.2		8.3	7.7		4.9	6.7	
32.0	13.2	9.7	7.8	13.7	9.8	7.8	10.1	7.9		8.1	7.3		4.6	6.3	
34.0	12.5	9.3	7.6	13.0	9.4	7.6	9.6	7.5	6.4	7.9	7.0		4.2	5.9	
36.0	11.9	9.0	7.4	12.4	9.1	7.4	9.1	7.2	6.2	7.7	6.7	5.8	3.9	5.5	4.7
38.0	11.4	8.7	7.2	11.8	8.8	7.2	8.7	7.0	6.0	7.5	6.4	5.6	3.5	5.2	4.4
40.0	10.9	8.4	7.0	11.3	8.5	7.1	8.3	6.7	5.8	7.3	6.2	5.4	3.2	4.9	4.2
44.0	9.9	7.8	6.7	9.9	8.0	6.8	7.6	6.2	5.4	6.8	5.7	5.0	2.6	4.3	3.8
48.0	9.2	7.4	6.5	8.7	7.5	6.5	7.0	5.8	5.1	6.2	5.2	4.6	2.1	3.9	3.4
52.0	8.3	7.0	6.3	7.6	7.2	6.3	6.5	5.5	4.9	5.6	4.7	4.2	1.6	3.4	3.1
56.0	7.3	6.7	6.1	6.7	6.7	6.1	6.0	5.1	4.6	5.0	4.3	3.9		3.0	2.8
60.0	6.5	6.4	6.1	5.9	5.9	5.9	5.6	4.8	4.4	4.6	3.9	3.6		2.5	2.5
64.0	5.8	5.8	5.8	5.2	5.2	5.2	4.9	4.5	4.2	4.1	3.6	3.3		2.1	2.2
68.0	4.1	5.1		4.6	4.6	4.6	4.3	4.3	4.0	3.8	3.3	3.1		1.8	1.9
72.0				3.8	4.0		3.7	3.8	3.8	3.3	3.1	2.9			1.6
76.0							3.1	3.3		2.9	2.8	2.8			
80.0										2.5	2.6				

Tragfähigkeiten
Lifting capacities
Capacités de levage
Capacidades de elevación



Lift Height (m)	40.4 m + 37.5 m			45.4 m + 37.5 m			50.5 m + 37.5 m			55.6 m + 37.5 m			60.0 m + 37.5 m		
	0°	20°	40°	0°	20°	40°	0°	20°	40°	0°	20°	40°	0°	20°	40°
12.0	14.1														
14.0	14.1			12.2											
16.0	14.1			12.2			8.8			6.0					
18.0	14.1			12.2			8.8			6.0			4.7		
20.0	14.1			12.2			8.8			6.0			4.4		
22.0	14.1			12.2			8.8			6.0			4.2		
24.0	13.9			12.2			8.8			6.0			3.8		
26.0	13.0	9.0		12.2	9.0		8.8			6.0			3.5		
28.0	12.2	8.6		12.2	8.6		8.8	7.8		5.8			3.2		
30.0	11.6	8.2		11.8	8.2		8.8	7.5		5.7	6.9		2.9		
32.0	10.9	7.8		11.2	7.9		8.8	7.1		5.5	6.5		2.6	5.4	
34.0	10.3	7.5		10.6	7.6		8.8	6.8		5.3	6.2		2.2	5.0	
36.0	9.8	7.2	5.8	10.1	7.3	5.8	8.4	6.5		5.2	5.9		1.9	4.7	
38.0	9.3	6.9	5.6	9.7	7.0	5.6	8.0	6.3	5.3	5.0	5.7		1.6	4.4	
40.0	8.9	6.7	5.5	9.2	6.8	5.5	7.6	6.0	5.1	4.8	5.4	4.6		4.1	
44.0	8.1	6.2	5.2	8.4	6.3	5.2	6.9	5.6	4.7	4.3	4.9	4.2		3.6	3.1
48.0	7.4	5.8	4.9	7.7	5.9	4.9	6.3	5.2	4.4	3.9	4.3	3.8		3.2	2.7
52.0	6.8	5.5	4.7	7.0	5.6	4.7	5.8	4.7	4.0	3.4	3.9	3.4		2.8	2.4
56.0	6.3	5.2	4.5	6.1	5.3	4.6	5.4	4.4	3.7	3.0	3.5	3.1		2.4	2.2
60.0	5.9	4.9	4.4	5.4	5.0	4.4	4.9	4.0	3.5	2.5	3.1	2.8		2.1	1.9
64.0	5.3	4.7	4.3	4.7	4.7	4.3	4.5	3.7	3.3	2.1	2.8	2.5		1.6	1.7
68.0	4.7	4.5	4.3	4.1	4.1	4.2	3.9	3.4	3.1	1.6	2.5	2.3			1.5
72.0	4.1	4.1		3.6	3.6	3.7	3.3	3.2	2.9		2.3	2.1			
76.0				3.1	3.1		2.9	2.9	2.8		2.1	1.9			
80.0							2.4	2.5	2.5		1.9	1.8			
84.0								2.1	2.1		1.7	1.7			



Lift Height (m)	40.4 m + 43.5 m			45.4 m + 43.5 m			50.5 m + 43.5 m			55.6 m + 43.5 m			60.0 m + 43.5 m		
	0°	20°	40°	0°	20°	40°	0°	20°	40°	0°	20°	40°	0°	20°	40°
14.0	10.1														
16.0	10.1			8.6			5.9								
18.0	10.1			8.6			5.9			3.5					
20.0	10.1			8.6			5.9			3.5			2.2		
22.0	10.1			8.6			5.9			3.5			1.9		
24.0	10.1			8.6			5.9			3.5			1.6		
26.0	10.1			8.6			5.9			3.4					
28.0	10.1	6.9		8.6			5.9			3.2					
30.0	9.5	6.5		8.6	6.5		5.9			3.1					
32.0	9.0	6.2		8.6	6.2		5.9	6.1		2.9					
34.0	8.4	5.9		8.6	5.9		5.9	5.9		2.8	4.8				
36.0	8.0	5.7		8.2	5.7		5.9	5.6		2.6	4.8			3.1	
38.0	7.6	5.4		7.8	5.5		5.9	5.3		2.4	4.6			3.1	
40.0	7.2	5.2	4.0	7.4	5.2		5.9	5.0		2.2	4.3			3.1	
44.0	6.5	4.8	3.7	6.7	4.8	3.7	5.9	4.4	3.5	1.8	3.7			2.7	
48.0	5.9	4.4	3.5	6.1	4.5	3.5	5.3	4.0	3.2		3.2	2.7		2.3	1.9
52.0	5.3	4.1	3.2	5.6	4.2	3.3	4.7	3.5	2.8		2.8	2.3		1.9	1.6
56.0	4.9	3.8	3.0	5.1	3.9	3.1	4.1	3.2	2.6		2.4	2.0		1.6	
60.0	4.5	3.5	2.9	4.6	3.6	2.9	3.7	2.8	2.3		2.1	1.7			
64.0	4.1	3.2	2.7	3.9	3.3	2.8	3.3	2.5	2.1		1.8	1.5			
68.0	3.8	3.0	2.6	3.3	3.1	2.6	2.9	2.3	1.9		1.5				
72.0	3.3	2.8	2.6	2.8	2.9	2.5	2.5	2.0	1.7						
76.0	2.9	2.7	2.6	2.3	2.4	2.5	2.0	1.8	1.6						
80.0	1.8	2.5		1.9	2.0	2.0	1.6	1.6	1.5						
84.0				1.6	1.6										

MB + FJ + PS

Tragfähigkeiten
Lifting capacities
Capacités de levage
Capacidades de elevación

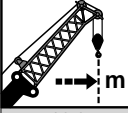

 m	40.4 m + 49.5 m			45.4 m + 49.5 m			50.5 m + 49.5 m			55.6 m + 49.5 m					
	0°	20°	40°	0°	20°	40°	0°	20°	40°	0°	20°	40°			
16.0	6.7			5.5											
18.0	6.7			5.5			3.2								
20.0	6.7			5.5			3.2								
22.0	6.7			5.5			3.2								
24.0	6.7			5.5			3.2								
26.0	6.7			5.5			3.2								
28.0	6.7			5.5			3.2								
30.0	6.7			5.5			3.2								
32.0	6.7	4.8		5.5			3.2								
34.0	6.6	4.5		5.5	4.4		3.2								
36.0	6.2	4.3		5.5	4.2		3.2	4.1							
38.0	5.8	4.1		5.5	4.0		3.2	3.9			2.3				
40.0	5.5	3.9		5.5	3.8		3.2	3.7			2.3				
44.0	4.9	3.5		5.0	3.5		3.2	3.4			2.3				
48.0	4.4	3.1	2.2	4.6	3.2	2.2	3.2	3.0			2.3				
52.0	4.0	2.8	2.0	4.1	2.9	2.0	3.2	2.6	1.9		2.0	1.5			
56.0	3.6	2.5	1.8	3.8	2.6	1.8	3.2	2.2	1.6		1.6				
60.0	3.3	2.2	1.6	3.4	2.3	1.6	2.7	1.9							
64.0	2.9	2.0	1.5	3.1	2.1	1.5	2.3	1.6							
68.0	2.5	1.8		2.7	1.9		2.0								
72.0	2.3	1.6		2.2	1.7		1.7								
76.0	2.0			1.7	1.5										
80.0	1.8														
84.0	1.5														



Tragfähigkeiten
Lifting capacities
Capacités de levage
Capacidades de elevación



m	40.4 m + 13.5 m			45.4 m + 13.5 m			50.5 m + 13.5 m			55.6 m + 13.5 m			60.0 m + 13.5 m		
	0°	20°	40°	0°	20°	40°	0°	20°	40°	0°	20°	40°	0°	20°	40°
8.0	45.4														
9.0	45.4			36.6											
10.0	45.4			36.6			29.5								
11.0	45.4			36.6			29.4				22.4				
12.0	44.8	33.7		36.6			28.2				22.4			19.5	
14.0	42.2	32.1		36.6	30.8		26.1	20.3			22.4			19.5	
16.0	36.3	30.6	25.7	35.5	29.6	24.9	24.2	19.2			20.9	17.1		19.5	16.4
18.0	30.8	29.3	24.9	30.3	28.4	24.2	22.7	18.2	15.6		19.5	16.2	14.2	18.6	15.5
20.0	26.4	28.1	24.1	26.0	27.4	23.5	21.3	17.3	15.0		18.3	15.3	13.6	17.5	14.7
22.0	22.7	24.8	23.4	22.4	24.4	22.8	20.1	16.5	14.5		17.2	14.6	13.0	16.5	14.0
24.0	19.6	21.5	22.8	19.4	21.2	22.3	19.0	15.8	14.0		16.2	13.9	12.5	15.6	13.4
26.0	16.9	18.6	20.0	16.8	18.5	19.9	16.9	15.2	13.5		15.4	13.3	12.0	14.8	12.8
28.0	14.4	15.9	17.1	14.7	16.2	17.4	14.8	14.6	13.1		14.6	12.7	11.5	14.0	12.2
30.0	12.2	13.6	14.6	12.6	14.0	15.1	13.0	14.0	12.7		13.1	12.2	11.1	12.7	11.7
32.0	10.4	11.6	12.5	10.8	12.0	13.0	11.2	12.4	12.3		11.5	11.7	10.8	11.1	11.2
34.0	8.8	9.9	10.7	9.2	10.3	11.1	9.6	10.7	11.6		10.1	11.2	10.4	9.8	10.5
36.0	7.5	8.4	9.1	7.8	8.8	9.5	8.2	9.3	10.0		8.7	9.8	10.1	8.5	9.6
38.0	6.3	7.1	7.7	6.6	7.5	8.1	7.0	7.9	8.6		7.5	8.5	9.1	7.4	8.4
40.0	5.2	5.9	6.4	5.5	6.3	6.9	5.9	6.8	7.4		6.4	7.3	7.9	6.3	7.2
44.0	3.4	3.9	4.1	3.7	4.3	4.7	4.1	4.8	5.2		4.6	5.3	5.8	4.5	5.2
48.0	1.9	2.2		2.2	2.7	2.9	2.6	3.2	3.5		3.0	3.7	4.0	3.0	3.6
52.0								1.8	2.0		1.8	2.3	2.5	1.7	2.2



m	40.4 m + 19.5 m			45.4 m + 19.5 m			50.5 m + 19.5 m			55.6 m + 19.5 m			60.0 m + 19.5 m		
	0°	20°	40°	0°	20°	40°	0°	20°	40°	0°	20°	40°	0°	20°	40°
9.0	32.6														
10.0	32.6			28.2											
11.0	32.6			28.2			21.6								
12.0	32.6			28.2			21.6				16.7				
14.0	32.6			28.2			21.6				16.7			14.5	
16.0	31.2	23.3		28.2	22.3		21.3				16.7			14.4	
18.0	29.4	22.2		28.1	21.4		19.8	15.0			16.7	13.6		14.0	
20.0	26.4	21.3	17.7	25.8	20.6		18.5	14.3			16.0	12.8		13.6	12.4
22.0	22.8	20.4	17.1	22.3	19.8	16.7	17.4	13.6	11.5		15.0	12.2		13.1	11.8
24.0	19.8	19.6	16.6	19.4	19.1	16.2	16.4	13.0	11.1		14.1	11.6	10.1	12.7	11.2
26.0	17.3	18.9	16.2	17.0	18.5	15.8	15.5	12.4	10.7		13.4	11.0	9.7	12.1	10.7
28.0	15.1	17.3	15.8	14.8	17.1	15.4	14.7	11.9	10.3		12.6	10.5	9.3	11.6	10.2
30.0	13.0	15.1	15.4	13.0	15.0	15.1	13.1	11.4	10.0		12.0	10.1	9.0	11.1	9.8
32.0	11.2	13.1	14.6	11.3	13.2	14.7	11.5	11.0	9.7		11.4	9.7	8.7	10.6	9.4
34.0	9.6	11.3	12.6	9.7	11.4	12.8	10.1	10.6	9.4		10.1	9.3	8.4	9.7	9.0
36.0	8.2	9.7	10.9	8.3	9.9	11.1	8.7	10.2	9.2		8.9	8.9	8.1	8.5	8.4
38.0	7.0	8.4	9.4	7.1	8.5	9.6	7.5	9.0	8.9		7.8	8.6	7.8	7.4	7.8
40.0	5.9	7.1	8.0	6.0	7.3	8.3	6.4	7.7	8.7		6.7	8.0	7.6	6.4	7.3
44.0	4.1	5.1	5.7	4.1	5.2	6.0	4.5	5.7	6.5		4.8	5.9	6.8	4.6	5.8
48.0	2.6	3.3	3.7	2.6	3.5	4.1	3.0	4.0	4.6		3.3	4.3	5.0	3.1	4.2
52.0		1.9			2.1	2.4	1.8	2.6	3.0		2.0	2.8	3.4		2.8
56.0									1.6			1.6	2.1		2.0

MB + FJ + PS

Tragfähigkeiten
Lifting capacities
Capacités de levage
Capacidades de elevación

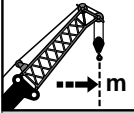

	40.4 m + 25.5 m			45.4 m + 25.5 m			50.5 m + 25.5 m			55.6 m + 25.5 m			60.0 m + 25.5 m		
	0°	20°	40°	0°	20°	40°	0°	20°	40°	0°	20°	40°	0°	20°	40°
10.0	24.7														
11.0	24.7														
12.0	24.7			21.4			16.6								
14.0	24.7			21.4			16.6			12.6			10.8		
16.0	24.7			21.4			16.6			12.6			10.8		
18.0	24.3	17.0		21.4			16.6			12.6			10.4		
20.0	23.0	16.2		21.4	16.2		16.3			12.6			10.0		
22.0	21.7	15.5		21.1	15.5		15.2	11.5		12.6	10.5		9.6		
24.0	19.9	14.8		19.4	14.8		14.3	10.9		12.6	9.9		9.2	9.6	
26.0	17.4	14.1	11.3	17.0	14.3	11.3	13.5	10.4		11.8	9.4		8.8	9.1	
28.0	15.3	13.6	11.0	14.9	13.7	11.0	12.7	10.0	8.5	11.1	9.0		8.3	8.7	
30.0	13.4	13.1	10.7	13.1	13.2	10.7	12.1	9.6	8.2	10.5	8.6	7.5	7.9	8.2	6.9
32.0	11.8	12.6	10.4	11.5	12.8	10.5	11.5	9.2	7.9	10.0	8.2	7.2	7.4	7.7	6.5
34.0	10.2	12.1	10.2	10.1	12.3	10.2	10.1	8.8	7.6	9.5	7.9	6.9	7.0	7.3	6.2
36.0	8.8	10.8	9.9	8.8	10.9	10.0	8.9	8.5	7.4	8.8	7.6	6.7	6.6	6.8	5.9
38.0	7.6	9.4	9.7	7.6	9.5	9.8	7.8	8.2	7.2	7.8	7.3	6.5	6.1	6.5	5.7
40.0	6.5	8.2	9.5	6.5	8.2	9.6	6.7	7.9	7.0	6.8	7.0	6.3	5.8	6.1	5.4
44.0	4.6	6.0	7.1	4.6	6.1	7.3	4.8	6.3	6.6	5.0	6.5	5.9	4.7	5.5	4.9
48.0	3.1	4.3	5.1	3.1	4.4	5.3	3.3	4.6	5.6	3.4	4.8	5.5	3.3	4.7	4.5
52.0	1.8	2.8	3.3	1.8	2.9	3.6	2.0	3.1	3.9	2.2	3.3	4.2		3.2	4.1
56.0		1.5	1.8		1.6	2.1		1.9	2.5		2.1	2.8			2.8

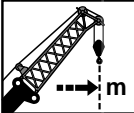

	40.4 m + 31.5 m			45.4 m + 31.5 m			50.5 m + 31.5 m			55.6 m + 31.5 m			60.0 m + 31.5 m		
	0°	20°	40°	0°	20°	40°	0°	20°	40°	0°	20°	40°	0°	20°	40°
11.0	18.6														
12.0	18.6			16.1											
14.0	18.6			16.1			12.4								
16.0	18.6			16.1			12.4			8.6			7.3		
18.0	18.6			16.1			12.4			8.6			7.0		
20.0	18.6			16.1			12.4			8.6			6.7		
22.0	17.8	12.1		16.1			12.4			8.6			6.3		
24.0	16.7	11.5		16.1	11.5		12.4	9.4		8.6			6.0		
26.0	15.7	11.0		15.7	11.0		11.9	9.0		8.6	8.5		5.6		
28.0	14.8	10.5		14.8	10.6		11.2	8.6		8.4	8.1		5.3	7.2	
30.0	13.4	10.1	8.1	13.0	10.2		10.6	8.2		8.3	7.7		4.9	6.7	
32.0	11.8	9.7	7.8	11.5	9.8	7.8	10.1	7.9		8.1	7.3		4.6	6.3	
34.0	10.4	9.3	7.6	10.1	9.4	7.6	9.6	7.5	6.4	7.9	7.0		4.2	5.9	
36.0	9.1	9.0	7.4	8.9	9.1	7.4	8.8	7.2	6.2	7.7	6.7	5.8	3.9	5.5	4.7
38.0	7.9	8.7	7.2	7.8	8.8	7.2	7.7	7.0	6.0	7.5	6.4	5.6	3.5	5.2	4.4
40.0	6.8	8.4	7.0	6.7	8.5	7.1	6.7	6.7	5.8	6.8	6.2	5.4	3.2	4.9	4.2
44.0	4.9	6.7	6.7	4.8	6.7	6.8	4.9	6.2	5.4	5.1	5.7	5.0	2.6	4.3	3.8
48.0	3.4	4.9	6.2	3.3	4.9	6.3	3.4	5.1	5.1	3.7	5.2	4.6	2.1	3.9	3.4
52.0	2.1	3.4	4.4	2.0	3.4	4.5	2.1	3.6	4.8	2.5	3.9	4.2		3.4	3.1
56.0		2.1	2.9		2.2	3.0		2.3	3.3		2.7	3.7			2.8
60.0			1.5									2.4			

Tragfähigkeiten
Lifting capacities
Capacités de levage
Capacidades de elevación



Lift Height (m)	40.4 m + 37.5 m			45.4 m + 37.5 m			50.5 m + 37.5 m			55.6 m + 37.5 m			60.0 m + 37.5 m		
	0°	20°	40°	0°	20°	40°	0°	20°	40°	0°	20°	40°	0°	20°	40°
12.0	14.1														
14.0	14.1			12.2											
16.0	14.1			12.2			8.8			6.0					
18.0	14.1			12.2			8.8			6.0			4.7		
20.0	14.1			12.2			8.8			6.0			4.4		
22.0	14.1			12.2			8.8			6.0			4.2		
24.0	13.9			12.2			8.8			6.0			3.8		
26.0	13.0	9.0		12.2	9.0		8.8			6.0			3.5		
28.0	12.2	8.6		12.2	8.6		8.8	7.8		5.8			3.2		
30.0	11.6	8.2		11.8	8.2		8.8	7.5		5.7	6.9		2.9		
32.0	10.9	7.8		11.2	7.9		8.8	7.1		5.5	6.5		2.6	5.4	
34.0	10.3	7.5		10.2	7.6		8.8	6.8		5.3	6.2		2.2	5.0	
36.0	9.4	7.2	5.8	9.0	7.3	5.8	8.4	6.5		5.2	5.9		1.9	4.7	
38.0	8.3	6.9	5.6	7.9	7.0	5.6	7.9	6.3	5.3	5.0	5.7		1.6	4.4	
40.0	7.2	6.7	5.5	6.9	6.8	5.5	6.9	6.0	5.1	4.8	5.4	4.6		4.1	
44.0	5.3	6.2	5.2	5.2	6.3	5.2	5.2	5.6	4.7	4.3	4.9	4.2		3.6	3.1
48.0	3.8	5.6	4.9	3.6	5.6	4.9	3.8	5.2	4.4	3.7	4.3	3.8		3.2	2.7
52.0	2.5	4.1	4.7	2.3	4.1	4.7	2.6	4.4	4.0	2.5	3.9	3.4		2.8	2.4
56.0		2.8	3.9		2.8	4.0		3.1	3.7		3.1	3.1		2.4	2.2
60.0		1.7	2.6			2.7			3.0			2.8			1.9



Lift Height (m)	40.4 m + 43.5 m			45.4 m + 43.5 m			50.5 m + 43.5 m			55.6 m + 43.5 m			60.0 m + 43.5 m		
	0°	20°	40°	0°	20°	40°	0°	20°	40°	0°	20°	40°	0°	20°	40°
14.0	10.1														
16.0	10.1			8.6			5.9								
18.0	10.1			8.6			5.9			3.5					
20.0	10.1			8.6			5.9			3.5			2.2		
22.0	10.1			8.6			5.9			3.5			1.9		
24.0	10.1			8.6			5.9			3.5			1.6		
26.0	10.1			8.6			5.9			3.4					
28.0	10.1	6.9		8.6			5.9			3.2					
30.0	9.5	6.5		8.6	6.5		5.9			3.1					
32.0	9.0	6.2		8.6	6.2		5.9	6.1		2.9					
34.0	8.4	5.9		8.6	5.9		5.9	5.9		2.8	4.8				
36.0	8.0	5.7		8.2	5.7		5.9	5.6		2.6	4.8			3.1	
38.0	7.6	5.4		7.7	5.5		5.9	5.3		2.4	4.6			3.1	
40.0	7.1	5.2	4.0	6.7	5.2		5.9	5.0		2.2	4.3			3.1	
44.0	5.4	4.8	3.7	5.0	4.8	3.7	4.9	4.4	3.5	1.8	3.7			2.7	
48.0	3.9	4.4	3.5	3.6	4.5	3.5	3.5	4.0	3.2		3.2	2.7		2.3	1.9
52.0	2.6	4.1	3.2		4.2	3.3		3.5	2.8		2.8	2.3		1.9	1.6
56.0		3.2	3.0		3.2	3.1		3.1	2.6		2.4	2.0			
60.0		2.1	2.9			2.9			2.3			1.7			

MB + FJ + PS

Tragfähigkeiten
Lifting capacities
Capacités de levage
Capacidades de elevación



	40.4 m + 49.5 m			45.4 m + 49.5 m			50.5 m + 49.5 m			55.6 m + 49.5 m					
	0°	20°	40°	0°	20°	40°	0°	20°	40°	0°	20°	40°			
16.0	6.7			5.5											
18.0	6.7			5.5			3.2								
20.0	6.7			5.5			3.2								
22.0	6.7			5.5			3.2								
24.0	6.7			5.5			3.2								
26.0	6.7			5.5			3.2								
28.0	6.7			5.5			3.2								
30.0	6.7			5.5			3.2								
32.0	6.7	4.8		5.5			3.2								
34.0	6.6	4.5		5.5	4.4		3.2								
36.0	6.2	4.3		5.5	4.2		3.2	4.1							
38.0	5.8	4.1		5.5	4.0		3.2	3.9			2.3				
40.0	5.5	3.9		5.5	3.8		3.2	3.7			2.3				
44.0	4.9	3.5		4.9	3.5		3.2	3.4			2.3				
48.0	3.9	3.1	2.2	3.5	3.2	2.2	3.2	3.0			2.3				
52.0	2.6	2.8	2.0		2.9	2.0		2.6	1.9		2.0	1.5			
56.0		2.5	1.8		2.6	1.8		2.2	1.6						
60.0			1.6			1.6									
64.0			1.5												

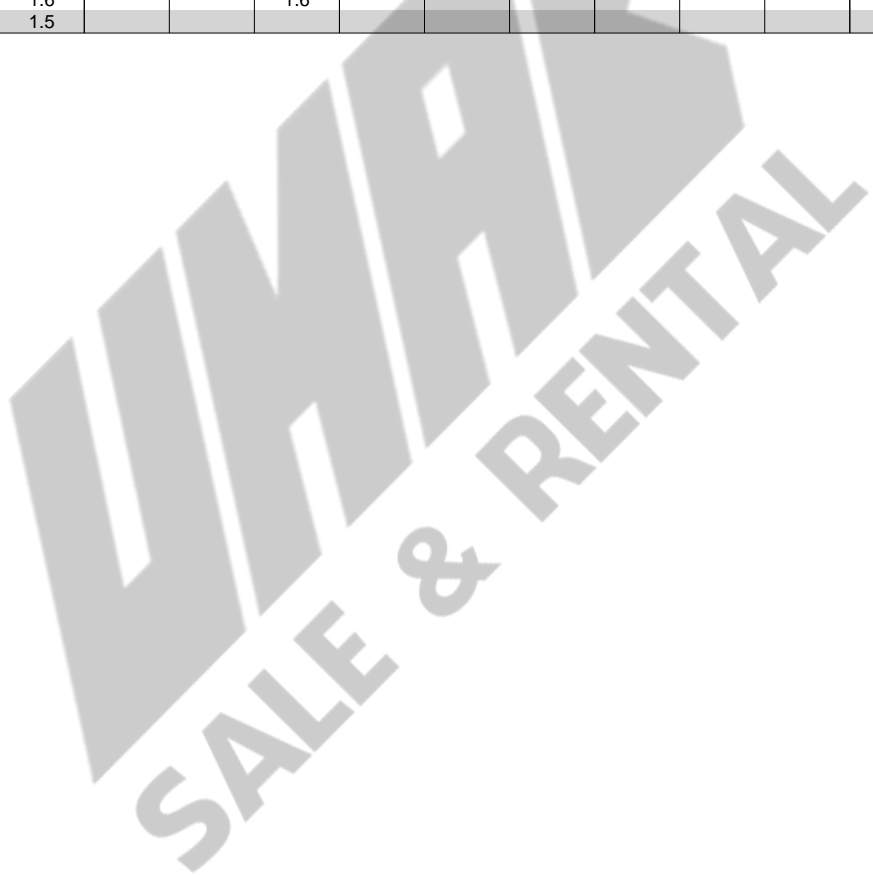

Notizen
Notes
Notas



**UNIVERSAL
SALE & RENTAL**

Hubhöhen
Lifting heights
Hauteurs de levage
Alturas de elevación

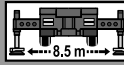
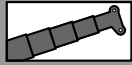

138t

DIN/ISO/EN

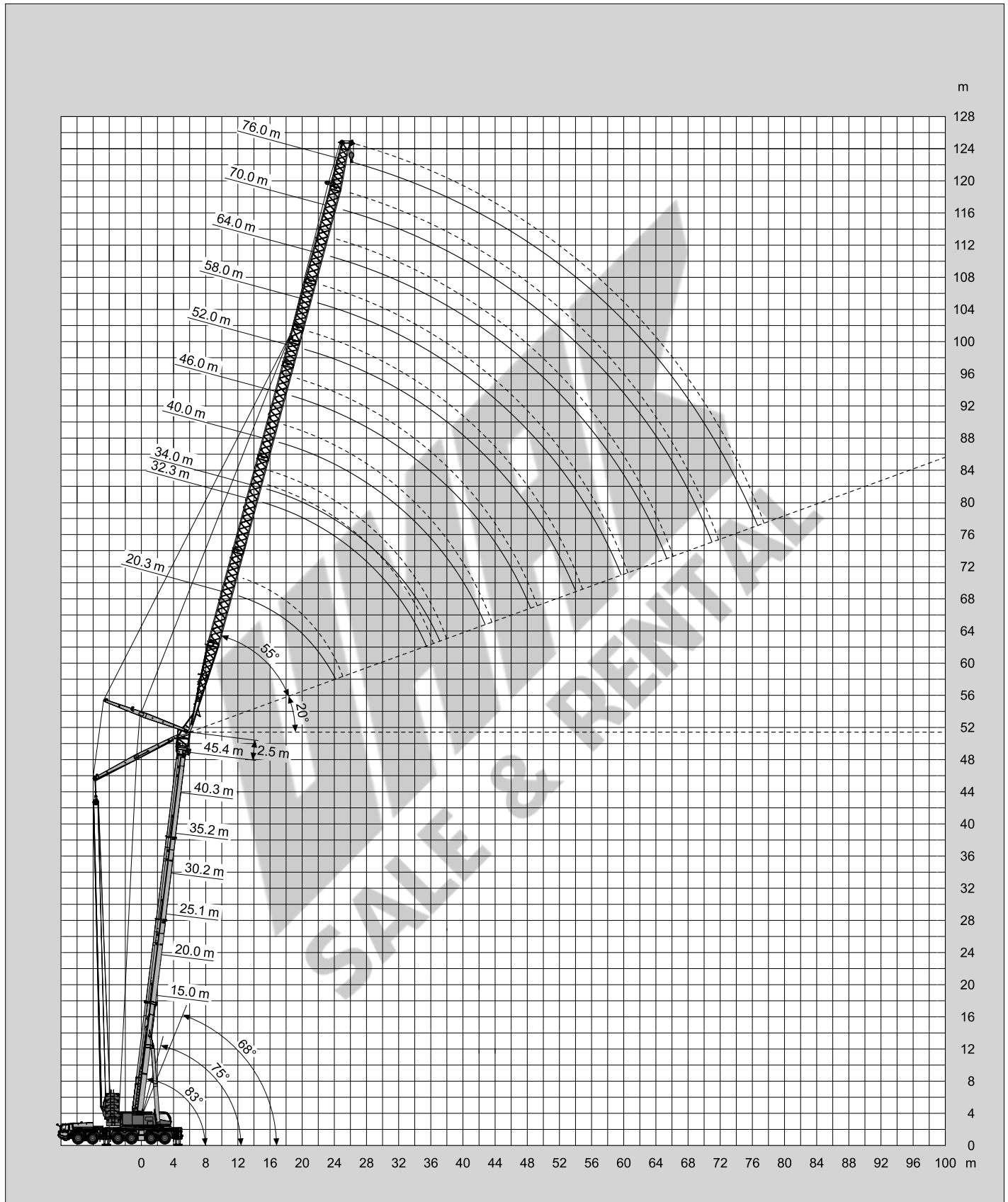

Tragfähigkeiten
Lifting capacities
Capacités de levage
Capacidades de elevación

138t

DIN/ISO/EN

m	15.0 m + 2.5 m + 20.3 m			20.1 m + 2.5 m + 20.3 m			25.1 m + 2.5 m + 20.3 m			30.2 m + 2.5 m + 20.3 m			35.3 m + 2.5 m + 20.3 m		
	83°	75°	68°	83°	75°	68°	83°	75°	68°	83°	75°	68°	83°	75°	68°
14.0							65.6								
16.0		67.4					59.2				55.8				
18.0		61.0			57.3		54.0				51.0			45.7	
20.0		55.8	56.5		52.4		47.1	47.6			46.4			41.6	
22.0		51.3	52.0		47.6		38.1	43.5			43.2	38.6		38.4	
24.0			47.8		44.8	41.8		40.3				35.5			31.9
26.0						39.0		38.2	35.3			33.1			29.4
28.0									32.9				28.4		27.4
30.0													23.8		
32.0															21.4
															19.6

138t

DIN/ISO/EN

m	40.4 m + 2.5 m + 20.3 m			45.4 m + 2.5 m + 20.3 m											
	83°	75°	68°	83°	75°	68°									
18.0	39.0														
20.0	36.6			30.7											
22.0	33.6			28.1											
24.0	31.3			24.1											
26.0		25.8													
28.0		22.1													
30.0		20.3													
32.0															

MB + LJ

Tragfähigkeiten
Lifting capacities
Capacités de levage
Capacidades de elevación

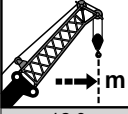

 m	15.0 m + 2.5 m + 32.3 m			20.1 m + 2.5 m + 32.3 m			25.1 m + 2.5 m + 32.3 m			30.2 m + 2.5 m + 32.3 m			35.3 m + 2.5 m + 32.3 m		
	83°	75°	68°	83°	75°	68°	83°	75°	68°	83°	75°	68°	83°	75°	68°
12.0	61.2														
14.0	59.6			49.5			43.5								
16.0	57.2			47.9			42.6			38.1					
18.0	52.2			46.8			41.8			37.5			32.4		
20.0	48.0	48.8		45.1	45.2		41.1			36.8			31.9		
22.0	44.4	45.1		41.8	41.8		39.5	38.8		36.3			31.5		
24.0	41.3	41.9	42.3	39.0	38.9		36.9	36.1		35.0	33.6		31.0		
26.0	38.6	39.2	39.4	36.5	36.4	36.0	34.6	33.8		32.8	31.5		30.4		
28.0	34.4	36.8	37.0	34.3	34.2	33.8	32.6	31.8		30.9	29.2		28.7	26.1	
30.0	28.6	34.6	34.8	32.4	32.2	31.8	30.8	29.9	29.1	29.2	27.3		27.1	22.4	
32.0	20.4	32.7	32.9	24.9	30.5	30.1	29.2	28.3	27.5	27.7	23.4	21.6	22.7	20.3	
34.0		24.9	31.1		28.9	28.5	21.9	26.9	23.8	25.7	21.3	20.0	21.2	19.0	17.8
36.0			29.4		27.3	26.0		23.0	21.7		20.0	18.7		17.7	16.5
38.0						23.0			22.2	20.4		17.5		16.7	15.4
40.0										19.3		16.4		15.8	14.4
42.0												15.5			13.5
44.0															12.7

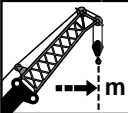

 m	40.4 m + 2.5 m + 32.3 m			45.4 m + 2.5 m + 32.3 m			50.5 m + 2.5 m + 32.3 m							
	83°	75°	68°	83°	75°	68°	83°	75°	68°					
20.0	22.5													
22.0	22.1			17.8			13.7							
24.0	21.7			17.7			13.7							
26.0	21.3			17.4			13.7							
28.0	21.0			17.1			13.5							
30.0	20.7	19.6		16.9			13.3							
32.0	19.6	18.1		16.1	15.3		13.2							
34.0	18.5	16.9		15.1	14.2		12.9	11.7						
36.0	17.6	15.7		14.2	13.2		11.8	10.9						
38.0		14.7	13.5		12.3			10.1						
40.0		13.8	12.6		11.5	11.0		9.4						
42.0		13.0	11.8		10.8	10.3		8.8						
44.0			11.0			9.6		8.2	7.6					
46.0			10.4			9.0			7.1					
48.0						8.4			6.6					
50.0									6.2					

Tragfähigkeiten
Lifting capacities
Capacités de levage
Capacidades de elevación



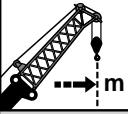

138t
DIN/ISO/EN

 m	15.0 m + 2.5 m + 34.0 m			20.1 m + 2.5 m + 34.0 m			25.1 m + 2.5 m + 34.0 m			30.2 m + 2.5 m + 34.0 m			35.3 m + 2.5 m + 34.0 m		
	83°	75°	68°	83°	75°	68°	83°	75°	68°	83°	75°	68°	83°	75°	68°
14.0	53.2			46.1											
16.0	48.3			45.0			40.1								
18.0	44.1			43.6			39.4								
20.0	40.6	44.5		40.7			38.6							30.0	
22.0	37.6	41.1		37.9	40.8		37.9							29.5	
24.0	35.0	38.0		35.4	38.0		35.6	35.1						29.1	
26.0	32.7	35.4	37.9	33.1	35.6		33.5	32.9						28.7	
28.0	30.7	33.0	35.3	31.1	33.4	33.0	31.6	30.9						27.8	
30.0	29.0	31.0	33.0	29.4	31.5	31.1	29.8	29.1	28.0					26.3	
32.0	24.2	29.2	31.0	27.8	29.8	29.1	28.2	27.5	25.4					25.0	22.1
34.0		27.6	29.2	21.2	28.3	26.1	22.5	23.3	21.9					21.6	20.4
36.0		21.2	27.5		25.3	22.9		22.0	20.5					20.4	19.0
38.0			22.9		21.4	21.7		20.9	19.2					17.7	
40.0						20.8		20.1	18.1					16.5	15.7
42.0									17.3					15.5	14.6
44.0														13.4	13.6
46.0															12.7



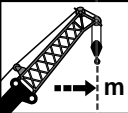

138t
DIN/ISO/EN

 m	40.4 m + 2.5 m + 34.0 m			45.4 m + 2.5 m + 34.0 m			50.5 m + 2.5 m + 34.0 m			55.6 m + 2.5 m + 34.0 m					
	83°	75°	68°	83°	75°	68°	83°	75°	68°	83°	75°	68°			
20.0	21.3														
22.0	20.9			17.0											
24.0	20.5			16.5			13.0					9.2			
26.0	20.2			16.2			12.8					9.0			
28.0	19.9			16.1			12.7					8.7			
30.0	19.6	19.5		15.9			12.6					8.6			
32.0	19.2	18.0		15.8	15.1		12.6					8.5			
34.0	18.4	16.8		15.2	14.0		12.5	11.6				8.5			
36.0	17.4	15.7		14.1	13.1		11.9	10.7				8.5			
38.0	16.6	14.7	13.4	13.3	12.2		11.0	10.0				8.5	8.0		
40.0		13.8	12.5		11.4			9.3				8.1	7.4		
42.0		13.0	11.7		10.7	10.1		8.7					6.9		
44.0		12.3	11.0		10.1	9.5		8.1	7.5				6.4		
46.0			10.3			8.9		7.6	7.0				6.0		
48.0			9.7			8.3			6.5				5.6	5.0	
50.0						7.8			6.1					4.7	
54.0														4.0	

MB + LJ

Tragfähigkeiten
Lifting capacities
Capacités de levage
Capacidades de elevación

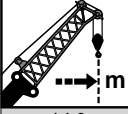

 m	15.0 m + 2.5 m + 40.0 m			20.1 m + 2.5 m + 40.0 m			25.1 m + 2.5 m + 40.0 m			30.2 m + 2.5 m + 40.0 m			35.3 m + 2.5 m + 40.0 m		
	83°	75°	68°	83°	75°	68°	83°	75°	68°	83°	75°	68°	83°	75°	68°
14.0	36.7														
16.0	33.2			33.2											
18.0	30.3			30.4			30.3								
20.0	27.5			28.0			28.2			20.6			21.8		
22.0	24.4	27.5		25.1			26.0			20.3			21.4		
24.0	22.1	24.3		22.3	26.0		23.1			19.8			21.0		
26.0	20.3	22.3		20.7	23.2		21.0	24.9		19.0			20.4		
28.0	18.8	20.6	22.2	19.2	21.4		19.5	22.2		18.0	19.7		19.6		
30.0	17.5	19.0	20.5	17.8	19.9		18.1	20.7		17.0	19.2		18.5	20.4	
32.0	16.3	17.7	19.0	16.6	18.4	20.2	16.9	19.2		16.0	18.2		17.4	19.9	
34.0	15.2	16.5	17.6	15.5	17.2	18.8	15.8	17.9	19.9	15.1	17.2		16.4	19.0	
36.0	14.3	15.4	16.4	14.5	16.0	17.5	14.8	16.7	18.6	14.2	16.2	17.9	15.4	17.9	
38.0	13.4	14.4	15.4	13.6	15.0	16.3	13.9	15.7	17.3	13.5	15.3	16.9	14.5	16.8	
40.0		13.5	14.4	12.8	14.1	15.3	13.1	14.7	16.2	12.7	14.4	16.0	13.7	15.8	14.5
42.0		12.8	13.5		13.2	14.3		13.8	15.2	12.1	13.7	15.1	12.9	14.9	13.6
44.0					12.5	13.5		13.0	14.3		12.9	14.3		14.1	12.8
46.0						12.7			13.4		12.3	13.6		13.4	12.1
48.0									12.7			12.9		12.7	11.4
50.0												12.2			10.8

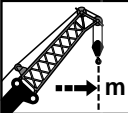

 m	40.4 m + 2.5 m + 40.0 m			45.4 m + 2.5 m + 40.0 m			50.5 m + 2.5 m + 40.0 m			55.6 m + 2.5 m + 40.0 m					
	83°	75°	68°	83°	75°	68°	83°	75°	68°	83°	75°	68°			
24.0	17.5			14.5											
26.0	17.0			14.3			11.7			9.4					
28.0	16.7			14.1			11.2			9.3					
30.0	16.4			14.1			10.9			9.2					
32.0	16.2			14.0			10.9			9.1					
34.0	15.8	16.4		13.9			10.9			8.9					
36.0	15.2	15.8		13.8	13.2		10.9			8.7					
38.0	14.5	14.8		13.5	12.3		10.7	9.9		8.4					
40.0	13.7	13.9		12.6	11.5		10.3	9.2		7.9	7.2				
42.0	13.0	13.1	11.8	11.9	10.8		9.7	8.6		7.4	6.7				
44.0	12.4	12.4	11.1	11.4	10.2		9.2	8.1		7.0	6.2				
46.0		11.7	10.4		9.6	8.9		7.6			5.8				
48.0		11.1	9.8		9.1	8.4		7.1	6.4		5.5				
50.0		10.6	9.2		8.6	7.9		6.7	6.0		5.1	4.5			
54.0			8.3			7.0			5.3		4.5	3.9			
58.0									4.6			3.4			

Tragfähigkeiten
Lifting capacities
Capacités de levage
Capacidades de elevación



	15.0 m + 2.5 m + 46.0 m			20.1 m + 2.5 m + 46.0 m			25.1 m + 2.5 m + 46.0 m			30.2 m + 2.5 m + 46.0 m			35.3 m + 2.5 m + 46.0 m		
	83°	75°	68°	83°	75°	68°	83°	75°	68°	83°	75°	68°	83°	75°	68°
16.0	25.8														
18.0	22.8			23.1											
20.0	20.6			20.6			20.5								
22.0	18.9			19.0			19.1			18.9				18.2	
24.0	17.4	19.1		17.5			17.7			17.7				17.8	
26.0	16.0	17.6		16.2	18.1		16.4			16.5				16.9	
28.0	14.8	16.2		15.0	16.8		15.2			15.4				15.9	
30.0	13.8	15.0		13.9	15.6		14.2	16.1		14.4				15.0	
32.0	12.8	13.9	14.9	13.0	14.4		13.2	15.0		13.5	15.5			14.0	
34.0	12.0	12.9	13.8	12.1	13.5	14.7	12.4	14.0		12.6	14.5			13.2	15.4
36.0	11.2	12.1	12.9	11.4	12.5	13.6	11.6	13.1		11.8	13.6			12.4	14.5
38.0	10.5	11.3	12.0	10.7	11.7	12.8	10.9	12.2	13.5	11.1	12.7			11.6	13.7
40.0	9.8	10.6	11.3	10.0	11.0	11.9	10.2	11.4	12.7	10.4	11.9	13.4		10.9	12.8
42.0	9.3	9.9	10.6	9.4	10.3	11.2	9.6	10.8	11.8	9.8	11.2	12.6		10.3	12.1
44.0	8.7	9.4	9.9	8.9	9.7	10.5	9.1	10.1	11.1	9.2	10.5	11.8		9.7	11.4
46.0		8.8	9.3	8.4	9.2	9.9	8.6	9.5	10.5	8.7	9.9	11.1		9.1	10.7
48.0		8.3	8.8		8.6	9.3		9.0	9.8		9.4	10.4		8.6	10.1
50.0						8.8			9.3		8.8	9.8			9.5
54.0								8.5	8.3			8.8			8.5
58.0															8.6



	40.4 m + 2.5 m + 46.0 m			45.4 m + 2.5 m + 46.0 m			50.5 m + 2.5 m + 46.0 m			55.6 m + 2.5 m + 46.0 m					
	83°	75°	68°	83°	75°	68°	83°	75°	68°	83°	75°	68°			
26.0	15.1			12.7			10.2								
28.0	14.8			12.6			10.1			7.8					
30.0	14.4			12.5			10.0			7.7					
32.0	13.8			12.4			9.8			7.6					
34.0	13.2			12.2			9.8			7.5					
36.0	12.6	14.4		11.9			9.7			7.4					
38.0	11.9	13.9		11.5	12.2		9.6			7.4					
40.0	11.3	13.2		11.1	11.4		9.5	9.0		7.3					
42.0	10.6	12.6		10.6	10.7		9.3	8.4		7.2					
44.0	10.1	12.0		10.1	10.1		9.0	7.9		6.8	6.0				
46.0	9.5	11.3	10.5	9.6	9.5		8.5	7.4		6.4	5.6				
48.0	9.0	10.7	9.9	9.2	9.0	8.2	8.1	7.0		6.1	5.2				
50.0		10.1	9.3	8.7	8.5	7.7	7.7	6.6		5.7	4.9				
54.0		9.1	8.3		7.6	6.9		5.9	5.1		4.3	3.7			
58.0			7.5			6.1		5.3	4.5		3.8	3.2			
62.0						5.5			3.9			2.7			
66.0												2.3			

MB + LJ

Tragfähigkeiten
Lifting capacities
Capacités de levage
Capacidades de elevación



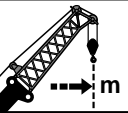

138t
DIN/ISO/EN

 m	15.0 m + 2.5 m + 46.0 m			20.1 m + 2.5 m + 46.0 m			25.1 m + 2.5 m + 46.0 m			30.2 m + 2.5 m + 46.0 m			35.3 m + 2.5 m + 46.0 m		
	83°	75°	68°	83°	75°	68°	83°	75°	68°	83°	75°	68°	83°	75°	68°
16.0	36.7														
18.0	35.8			30.8											
20.0	35.1			30.2			23.7								
22.0	34.3			29.7			23.2			18.5			17.9		
24.0	33.6			29.2			22.8			18.2			17.6		
26.0	32.5	32.7		28.7			22.4			17.9			17.4		
28.0	30.6	30.8		28.3	28.2		22.0			17.7			17.1		
30.0	29.0	29.2		27.1	26.5		21.7	21.8		17.4			16.9		
32.0	27.5	27.6	27.5	25.6	24.0		21.4	21.5		17.2	17.3		16.6		
34.0	26.2	26.3	26.1	23.4	23.5	23.5	21.1	21.1		17.0	17.1		16.4	16.6	
36.0	25.0	25.0	24.9	23.1	22.9	22.4	20.8	20.8		16.8	16.9		16.2	16.2	
38.0	22.1	23.9	23.7	22.4	21.9	21.4	20.5	20.1	19.3	16.6	16.6		16.1	15.2	
40.0	19.7	22.5	22.7	21.2	20.9	20.4	20.2	19.2	18.3	16.4	16.2	14.8	15.9	14.3	
42.0	17.0	20.8	21.7	19.3	20.0	19.5	19.4	18.3	17.2	16.3	15.3	13.8	15.5	13.5	11.8
44.0	14.4	19.1	20.8	16.7	19.3	18.4	18.3	17.3	16.2	16.2	14.4	13.0	15.0	12.7	11.1
46.0		16.8	19.2	13.7	18.5	17.5	16.0	16.5	15.3	16.0	13.7	12.2	14.3	12.0	10.4
48.0		13.9	17.8		17.2	16.6		15.8	14.5	15.3	13.0	11.5	13.8	11.3	9.8
50.0						16.0			15.2	13.7	12.4	10.9		10.8	9.2
54.0										12.6		9.8		9.8	8.2
58.0															7.4



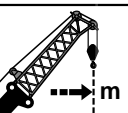

138t
DIN/ISO/EN

 m	40.4 m + 2.5 m + 46.0 m			45.4 m + 2.5 m + 46.0 m			50.5 m + 2.5 m + 46.0 m			55.6 m + 2.5 m + 46.0 m					
	83°	75°	68°	83°	75°	68°	83°	75°	68°	83°	75°	68°			
26.0	14.9			12.9			10.1								
28.0	14.8			12.8			10.0			7.7					
30.0	14.6			12.7			9.9			7.5					
32.0	14.4			12.5			9.8			7.5					
34.0	14.3			12.3			9.7			7.4					
36.0	14.2	14.5		12.2			9.6			7.3					
38.0	14.1	14.4		12.2	11.8		9.6			7.2					
40.0	14.0	13.6		11.9	11.1		9.5	8.7		7.1					
42.0	13.9	12.9		11.4	10.4		9.1	8.1		6.9	6.1				
44.0	13.5	12.1		10.8	9.7		8.7	7.6		6.5	5.6				
46.0	12.9	11.4	10.2	10.3	9.2		8.2	7.1		6.1	5.3				
48.0	12.4	10.8	9.5	9.8	8.6	7.9	7.7	6.7		5.7	4.9				
50.0		10.2	9.0	9.3	8.1	7.4	7.3	6.3	5.4	5.4	4.6				
54.0		9.2	7.9		7.3	6.5		5.5	4.7		4.0	3.3			
58.0			7.1			5.8		4.9	4.1		3.5	2.8			
62.0						5.2			3.6			2.4			
66.0												2.0			

Tragfähigkeiten
Lifting capacities
Capacités de levage
Capacidades de elevación

138t Light

DIN/ISO/EN

	15.0 m + 2.5 m + 52.0 m			20.1 m + 2.5 m + 52.0 m			25.1 m + 2.5 m + 52.0 m			30.2 m + 2.5 m + 52.0 m			35.3 m + 2.5 m + 52.0 m		
	83°	75°	68°	83°	75°	68°	83°	75°	68°	83°	75°	68°	83°	75°	68°
18.0	18.8														
20.0	17.2			17.1											
22.0	15.8			15.8			15.8								
24.0	14.6			14.6			14.7			14.6					
26.0	13.5			13.5			13.7			13.7			13.9		
28.0	12.5	13.6		12.6			12.7			12.8			13.2		
30.0	11.6	12.6		11.7	13.0		11.9			12.0			12.5		
32.0	10.8	11.7		10.9	12.1		11.1	12.5		11.2			11.9		
34.0	10.1	10.8		10.2	11.3		10.3	11.6		10.5	12.0		11.2		
36.0	9.4	10.2	10.8	9.5	10.5		9.7	10.9		9.8	11.3		10.5		
38.0	8.8	9.5	10.1	8.9	9.8	10.7	9.1	10.2		9.2	10.6		9.9	11.6	
40.0	8.3	8.9	9.5	8.4	9.2	10.0	8.5	9.6	10.5	8.7	9.9		9.3	11.0	
42.0	7.8	8.3	8.9	7.9	8.6	9.3	8.0	9.0	9.9	8.2	9.3		8.7	10.3	
44.0	7.3	7.8	8.3	7.4	8.1	8.8	7.6	8.4	9.3	7.7	8.8	9.8	8.2	9.7	
46.0	6.9	7.4	7.8	7.0	7.6	8.2	7.1	7.9	8.7	7.3	8.2	9.2	7.8	9.1	10.4
48.0	6.5	7.0	7.4	6.6	7.2	7.8	6.7	7.5	8.2	6.9	7.8	8.7	7.3	8.6	9.8
50.0	6.2	6.6	6.9	6.3	6.8	7.3	6.4	7.1	7.7	6.5	7.3	8.2	6.9	8.1	9.2
54.0		5.9	6.2		6.1	6.5		6.3	6.9	6.2	6.6	7.3	6.2	7.2	8.2
58.0									6.2		5.9	6.5	6.2	6.4	7.3
62.0											5.9		5.9		6.5

138t Light

DIN/ISO/EN

	40.4 m + 2.5 m + 52.0 m			45.4 m + 2.5 m + 52.0 m			50.5 m + 2.5 m + 52.0 m			55.6 m + 2.5 m + 52.0 m					
	83°	75°	68°	83°	75°	68°	83°	75°	68°	83°	75°	68°			
26.0	12.8														
28.0	12.5			10.8			8.5								
30.0	12.0			10.7			8.4								
32.0	11.5			10.4			8.3			6.1					
34.0	11.0			10.2			8.2			6.1					
36.0	10.4			9.8			8.1			6.0					
38.0	9.9			9.5			8.1			6.0					
40.0	9.4	10.9		9.1	10.2		8.0			5.9					
42.0	8.8	10.4		8.7	9.9		7.9			5.9					
44.0	8.4	9.9		8.3	9.6		7.7	7.8		5.9					
46.0	7.9	9.4		7.9	9.2		7.5	7.3		5.9	5.4				
48.0	7.5	8.9		7.6	8.9		7.2	6.9		5.8	5.1				
50.0	7.1	8.4	9.4	7.2	8.4		7.0	6.5		5.6	4.7				
54.0	6.3	7.5	8.4	6.5	7.6	6.8	6.5	5.8	4.9	5.0	4.2				
58.0		6.7	7.5		6.8	6.1		5.2	4.3	4.5	3.6				
62.0		6.1	6.7		6.2	5.4		4.6	3.8		3.2	2.5			
66.0			6.1			4.9			3.4		2.8	2.2			
70.0									3.0		2.5	1.8			
74.0												1.5			

MB + LJ

Tragfähigkeiten
Lifting capacities
Capacités de levage
Capacidades de elevación



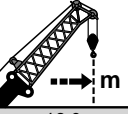

138t
DIN/ISO/EN

 m	15.0 m + 2.5 m + 52.0 m			20.1 m + 2.5 m + 52.0 m			25.1 m + 2.5 m + 52.0 m			30.2 m + 2.5 m + 52.0 m			35.3 m + 2.5 m + 52.0 m		
	83°	75°	68°	83°	75°	68°	83°	75°	68°	83°	75°	68°	83°	75°	68°
18.0	29.8														
20.0	29.2			22.3											
22.0	27.8			21.9			19.6								
24.0	25.4			21.5			19.3			14.8			16.0		
26.0	23.5			21.1			18.9			14.7			15.9		
28.0	22.2	24.5		20.7			18.6			14.6			15.7		
30.0	21.0	22.3		20.4	20.4		18.4			14.5			15.6		
32.0	19.8	21.1		19.5	20.1		18.1	18.1		14.5			15.5		
34.0	18.8	19.9		18.6	19.5		17.9	17.9		14.4	14.4		15.3		
36.0	17.8	18.9	19.8	17.7	19.0		17.5	17.6		14.3	14.3		15.2	15.4	
38.0	16.9	17.9	18.8	16.9	18.1	18.8	16.8	17.4		14.3	14.2		15.1	15.1	
40.0	16.1	17.0	17.9	16.1	17.2	18.2	16.1	17.0	16.8	14.2	14.2		15.0	14.4	
42.0	15.3	16.2	17.0	15.3	16.4	17.4	15.3	16.6	16.0	14.2	14.1		14.9	13.8	
44.0	14.6	15.4	16.1	14.6	15.7	16.6	14.7	15.9	15.4	14.1	14.1	13.6	14.8	13.2	
46.0	13.9	14.7	15.4	14.0	15.0	15.8	14.1	15.2	14.8	13.6	14.0	13.1	14.2	12.7	11.5
48.0	13.2	14.0	14.7	13.4	14.3	15.1	13.5	14.6	14.2	13.2	13.6	12.6	13.8	12.2	11.0
50.0	11.8	13.4	14.0	12.8	13.7	14.5	12.9	14.0	13.7	12.7	13.1	12.1	13.3	11.8	10.6
54.0		11.6	12.8		12.6	13.3		12.9	12.7	11.9	12.2	11.2	12.5	10.8	9.6
58.0									11.8			11.5	10.1	9.8	8.6
62.0												9.3			7.8



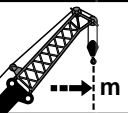

138t
DIN/ISO/EN

 m	40.4 m + 2.5 m + 52.0 m			45.4 m + 2.5 m + 52.0 m			50.5 m + 2.5 m + 52.0 m			55.6 m + 2.5 m + 52.0 m					
	83°	75°	68°	83°	75°	68°	83°	75°	68°	83°	75°	68°			
26.0	13.8														
28.0	13.7			11.2			8.6								
30.0	13.6			11.1			8.5								
32.0	13.5			11.0			8.4			6.0					
34.0	13.4			10.9			8.3			6.0					
36.0	13.3			10.8			8.2			6.0					
38.0	13.2			10.8			8.2			6.0					
40.0	13.0	12.6		10.7	10.8		8.1			5.9					
42.0	12.9	12.1		10.6	10.2		8.0			5.8					
44.0	12.8	11.6		10.4	9.7		8.0	7.5		5.8					
46.0	12.6	11.1		10.2	9.1		7.9	7.0		5.8	5.1				
48.0	12.3	10.7		9.7	8.6		7.7	6.6		5.6	4.7				
50.0	11.8	10.3	9.0	9.2	8.1		7.3	6.2		5.3	4.4				
54.0	10.9	9.3	8.0	8.4	7.3	6.5	6.6	5.5	4.6	4.7	3.8				
58.0		8.4	7.2		6.5	5.7		4.8	4.0	4.2	3.3				
62.0		7.7	6.4		5.9	5.1		4.3	3.5		2.9	2.2			
66.0			5.8			4.5			3.0		2.5	1.8			
70.0									2.6		2.2	1.5			

Tragfähigkeiten
Lifting capacities
Capacités de levage
Capacidades de elevación

138t Light

DIN/ISO/EN

 m	15.0 m + 2.5 m + 58.0 m			20.1 m + 2.5 m + 58.0 m			25.1 m + 2.5 m + 58.0 m			30.2 m + 2.5 m + 58.0 m			35.3 m + 2.5 m + 58.0 m		
	83°	75°	68°	83°	75°	68°	83°	75°	68°	83°	75°	68°	83°	75°	68°
22.0	20.9			19.1											
24.0	19.9			18.8			16.8								
26.0	18.8			18.1			16.6			16.4			14.5		
28.0	17.6			17.3			16.3			16.1			14.4		
30.0	16.7			16.4			16.1			15.7			14.2		
32.0	15.7	16.8		15.6			15.4			15.3			14.1		
34.0	14.8	15.8		14.8	16.0		14.7			14.7			13.8		
36.0	14.0	15.0		14.0	15.2		14.0	15.1		14.1			13.5		
38.0	13.3	14.1		13.3	14.4		13.3	14.5		13.5	14.8		13.1	13.9	
40.0	12.6	13.4	14.1	12.7	13.7		12.7	13.9		12.9	14.2		12.6	13.5	
42.0	12.0	12.7	13.4	12.0	13.0	13.8	12.1	13.2		12.4	13.6		12.2	13.2	
44.0	11.4	12.1	12.7	11.5	12.3	13.1	11.5	12.6	13.5	11.8	13.0		11.7	12.7	
46.0	10.8	11.5	12.0	10.9	11.7	12.5	11.0	12.0	12.9	11.3	12.5		11.3	12.2	
48.0	10.3	10.9	11.4	10.4	11.2	11.9	10.5	11.5	12.3	10.8	11.9	11.4	10.8	11.6	
50.0	9.8	10.4	10.9	9.9	10.7	11.3	10.0	10.9	11.7	10.3	11.4	11.0	10.4	10.9	9.4
54.0	9.0	9.5	9.9	9.1	9.7	10.3	9.2	10.0	10.7	9.4	10.4	10.2	9.6	9.8	8.3
58.0		8.7	9.1		8.9	9.4	8.4	9.1	9.8	8.7	9.6	9.2	8.8	8.9	7.4
62.0						8.6		8.4	9.0		8.8	8.3		8.1	6.6
66.0												7.6		7.5	6.0
70.0															5.4

138t Light

DIN/ISO/EN

 m	40.4 m + 2.5 m + 58.0 m			45.4 m + 2.5 m + 58.0 m			50.5 m + 2.5 m + 58.0 m			55.6 m + 2.5 m + 58.0 m					
	83°	75°	68°	83°	75°	68°	83°	75°	68°	83°	75°	68°			
28.0	11.8														
30.0	11.7														
32.0	11.7			9.3			6.9			4.9					
34.0	11.6			9.3			6.9			4.9					
36.0	11.5			9.2			6.8			4.8					
38.0	11.4			9.1			6.7			4.8					
40.0	11.3	11.4		9.1			6.7			4.7					
42.0	11.1	11.4		9.0			6.7			4.6					
44.0	10.9	11.3		9.0			6.6			4.6					
46.0	10.6	11.1		8.9	8.8		6.6			4.6					
48.0	10.4	10.8		8.9	8.5		6.6	6.4		4.6	4.5				
50.0	10.1	10.3		8.9	8.0		6.6	6.0		4.6	4.2				
54.0	9.4	9.3	8.0	8.2	7.1		6.3	5.3		4.5	3.6				
58.0	8.8	8.3	7.1	7.5	6.4		5.8	4.7		4.0	3.1				
62.0		7.5	6.4	6.9	5.7	5.0	5.2	4.1	3.3	3.6	2.7	1.9			
66.0		6.9	5.7		5.2	4.4	4.8	3.7	2.8		2.3	1.6			
70.0			5.1		4.7	3.9		3.2	2.4		2.0				
74.0						3.5		2.9	2.1						
78.0									1.8						

MB + LJ

Tragfähigkeiten
Lifting capacities
Capacités de levage
Capacidades de elevación

138t

DIN/ISO/EN

m	15.0 m + 2.5 m + 58.0 m			20.1 m + 2.5 m + 58.0 m			25.1 m + 2.5 m + 58.0 m			30.2 m + 2.5 m + 58.0 m			35.3 m + 2.5 m + 58.0 m		
	83°	75°	68°	83°	75°	68°	83°	75°	68°	83°	75°	68°	83°	75°	68°
20.0	25.6														
22.0	23.9			19.9											
24.0	23.0			19.7			17.5								
26.0	22.6			19.4			17.3			16.7			14.6		
28.0	22.3			19.2			17.1			16.5			14.4		
30.0	22.0	22.1		19.0			16.9			16.3			14.3		
32.0	21.6	21.7		18.7	18.8		16.7			16.2			14.2		
34.0	21.3	21.5		18.5	18.6		16.6			16.0			14.0		
36.0	20.8	20.6		18.3	18.4		16.4	16.5		15.8			13.9		
38.0	19.9	19.7		18.1	18.0		16.2	16.4		15.7	15.1		13.8	13.9	
40.0	19.1	18.9	18.6	17.9	17.3		16.1	15.7		15.6	14.4		13.7	13.7	
42.0	18.4	18.1	17.8	17.2	16.6	16.0	16.0	15.0		15.1	13.8		13.6	13.1	
44.0	17.7	17.4	17.1	16.6	15.9	15.3	15.5	14.4	13.5	14.6	13.2		13.5	12.6	
46.0	17.1	16.8	16.5	16.0	15.3	14.7	14.9	13.8	13.0	14.0	12.7	11.6	13.4	11.9	
48.0	16.0	16.2	15.9	15.4	14.7	14.2	14.4	13.3	12.4	13.5	12.2	11.1	13.0	11.2	
50.0	14.7	15.7	15.3	14.9	14.2	13.6	13.9	12.8	12.0	13.0	11.7	10.7	12.6	10.6	9.1
54.0	11.3	14.3	14.4	13.0	13.3	12.7	13.0	11.9	11.1	12.2	10.9	9.8	11.5	9.5	8.0
58.0		11.5	13.3		12.5	11.9	10.9	11.2	10.3	11.5	10.2	9.1	10.6	8.5	7.1
62.0						10.8		10.5	9.5		9.5	8.5		7.7	6.3
66.0												7.5		7.1	5.6
70.0															5.1

138t

DIN/ISO/EN

m	40.4 m + 2.5 m + 58.0 m			45.4 m + 2.5 m + 58.0 m			50.5 m + 2.5 m + 58.0 m			55.6 m + 2.5 m + 58.0 m					
	83°	75°	68°	83°	75°	68°	83°	75°	68°	83°	75°	68°			
28.0	11.8														
30.0	11.7														
32.0	11.6			9.2			6.7			4.7					
34.0	11.5			9.1			6.6			4.6					
36.0	11.4			9.0			6.6			4.6					
38.0	11.3			9.0			6.6			4.6					
40.0	11.2			8.9			6.5			4.5					
42.0	11.1	11.2		8.8			6.5			4.4					
44.0	11.0	11.2		8.8			6.4			4.3					
46.0	11.0	10.7		8.7	8.5		6.4			4.3					
48.0	10.9	10.3		8.7	8.1		6.4	6.0		4.3	4.1				
50.0	10.8	9.9		8.6	7.6		6.4	5.7		4.3	3.8				
54.0	10.2	8.9	7.7	7.9	6.8		6.0	4.9		4.2	3.2				
58.0	9.4	8.0	6.8	7.1	6.0		5.4	4.3		3.6	2.7				
62.0		7.2	6.0	6.6	5.4	4.6	4.9	3.8	2.9	3.2	2.3	1.6			
66.0		6.5	5.3		4.8	4.0	4.5	3.3	2.5		1.9				
70.0			4.8		4.4	3.6		2.9	2.1		1.6				
74.0						3.1		2.6	1.7						
78.0									1.5						

Tragfähigkeiten
Lifting capacities
Capacités de levage
Capacidades de elevación



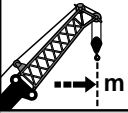

138t Light
DIN/ISO/EN

 m	15.0 m + 2.5 m + 64.0 m			20.1 m + 2.5 m + 64.0 m			25.1 m + 2.5 m + 64.0 m			30.2 m + 2.5 m + 64.0 m			35.3 m + 2.5 m + 64.0 m		
	83°	75°	68°	83°	75°	68°	83°	75°	68°	83°	75°	68°	83°	75°	68°
24.0	16.5														
26.0	15.6			15.0			14.6								
28.0	14.8			14.4			14.1			13.4					
30.0	13.9			13.7			13.5			13.0					
32.0	13.1			13.0			12.9			12.5			11.7		
34.0	12.4	13.2		12.4			12.3			12.0			11.4		
36.0	11.7	12.5		11.7	12.7		11.7			11.6			11.0		
38.0	11.1	11.8		11.1	12.0		11.1	12.2		11.1			10.7		
40.0	10.5	11.2		10.5	11.4		10.6	11.6		10.6	11.6		10.3		
42.0	9.9	10.6	11.1	10.0	10.8		10.1	11.0		10.1	11.1		9.9		
44.0	9.4	10.0	10.5	9.5	10.3		9.6	10.5		9.6	10.7		9.5	10.5	
46.0	9.0	9.5	10.0	9.0	9.8	10.4	9.1	10.0		9.2	10.2		9.1	10.1	
48.0	8.5	9.0	9.5	8.6	9.3	9.9	8.7	9.5	10.3	8.8	9.7		8.8	9.7	
50.0	8.1	8.6	9.0	8.2	8.8	9.4	8.3	9.1	9.8	8.4	9.3	10.1	8.4	9.4	
54.0	7.4	7.8	8.2	7.5	8.0	8.5	7.6	8.3	8.9	7.7	8.5	9.2	7.7	8.6	
58.0	6.7	7.1	7.4	6.8	7.3	7.8	6.9	7.5	8.1	7.0	7.8	8.4	7.1	7.9	7.2
62.0	6.2	6.5	6.8	6.3	6.7	7.1	6.4	6.9	7.4	6.4	7.1	7.7	6.5	7.3	6.6
66.0			6.2		6.1	6.5		6.3	6.8		6.5	7.1	6.0	6.7	5.9
70.0									6.2		6.0	6.5		6.2	5.3
74.0											6.0				4.8



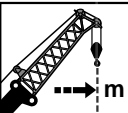

138t Light
DIN/ISO/EN

 m	40.4 m + 2.5 m + 64.0 m			45.4 m + 2.5 m + 64.0 m			50.5 m + 2.5 m + 64.0 m			55.6 m + 2.5 m + 64.0 m					
	83°	75°	68°	83°	75°	68°	83°	75°	68°	83°	75°	68°			
32.0	9.8			7.9			5.7			4.1					
34.0	9.8			7.8			5.7			4.0					
36.0	9.7			7.8			5.6			4.0					
38.0	9.6			7.7			5.5			3.9					
40.0	9.4			7.7			5.4			3.9					
42.0	9.2			7.6			5.4			3.9					
44.0	8.9			7.6			5.4			3.8					
46.0	8.7	9.3		7.5	7.6		5.4			3.8					
48.0	8.4	9.1		7.5	7.5		5.4	5.5		3.7					
50.0	8.2	8.9		7.5	7.5		5.4	5.4		3.7					
54.0	7.6	8.4		7.1	7.0		5.4	5.1		3.7	3.4				
58.0	7.1	7.8		6.8	6.3		5.3	4.5		3.6	2.9				
62.0	6.6	7.2	6.0	6.4	5.6	4.8	5.1	4.0	3.1	3.4	2.4				
66.0	6.1	6.8	5.5	6.0	5.0	4.2	4.6	3.5	2.6		2.1				
70.0		6.2	5.0		4.5	3.7		3.1	2.2		1.7				
74.0		5.7	4.3		4.1	3.3		2.7	1.9		1.5				
78.0			3.7			2.9			1.6						

MB + LJ

Tragfähigkeiten
Lifting capacities
Capacités de levage
Capacidades de elevación



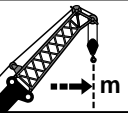

138t
DIN/ISO/EN

 m	15.0 m + 2.5 m + 64.0 m			20.1 m + 2.5 m + 64.0 m			25.1 m + 2.5 m + 64.0 m			30.2 m + 2.5 m + 64.0 m			35.3 m + 2.5 m + 64.0 m		
	83°	75°	68°	83°	75°	68°	83°	75°	68°	83°	75°	68°	83°	75°	68°
24.0	19.3			16.6											
26.0	19.1			16.4			15.8			14.7					
28.0	18.8			16.2			15.7			14.6			12.6		
30.0	18.6			16.0			15.5			14.4			12.5		
32.0	18.3			15.8			15.3			14.3			12.4		
34.0	18.1	18.2		15.7			15.2			14.2			12.3		
36.0	17.9	17.9		15.5	15.6		15.0			14.1			12.2		
38.0	17.7	17.6		15.4	15.4		14.9	14.7		13.9			12.1		
40.0	17.2	16.9		15.2	15.3		14.8	14.1		13.8	13.8		12.0		
42.0	16.6	16.2	15.9	15.1	14.9		14.6	13.5		13.7	13.2		11.9	11.7	
44.0	16.0	15.7	15.3	14.9	14.3		14.1	13.0		13.6	12.7		11.8	11.2	
46.0	15.5	15.1	14.8	14.5	13.8	13.2	13.6	12.5		13.5	12.1		11.7	10.7	
48.0	15.0	14.6	14.2	14.0	13.3	12.7	13.1	12.0	11.2	13.0	11.7		11.7	10.3	
50.0	14.5	14.1	13.8	13.6	12.8	12.2	12.6	11.6	10.7	12.5	11.2	10.1	11.5	9.9	
54.0	13.4	13.2	12.9	12.7	12.0	11.4	11.8	10.8	9.9	11.7	10.4	9.3	10.7	9.1	7.9
58.0	10.8	12.5	12.1	12.0	11.3	10.7	11.1	10.1	9.2	10.9	9.6	8.6	10.0	8.5	7.3
62.0	8.1	11.1	11.5	9.4	10.6	10.0	10.5	9.5	8.6	10.3	9.0	8.0	9.4	7.9	6.7
66.0			10.3		10.1	9.2		8.9	8.0		8.4	7.2	8.9	7.3	6.1
70.0									7.1		7.8	6.4		6.9	5.3
74.0												5.7			4.6



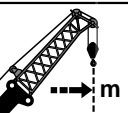

138t
DIN/ISO/EN

 m	40.4 m + 2.5 m + 64.0 m			45.4 m + 2.5 m + 64.0 m			50.5 m + 2.5 m + 64.0 m			55.6 m + 2.5 m + 64.0 m					
	83°	75°	68°	83°	75°	68°	83°	75°	68°	83°	75°	68°			
32.0	9.9			7.8			5.4			3.8					
34.0	9.9			7.8			5.3			3.8					
36.0	9.8			7.7			5.3			3.7					
38.0	9.7			7.7			5.2			3.7					
40.0	9.7			7.6			5.2			3.7					
42.0	9.6			7.6			5.2			3.6					
44.0	9.5			7.5			5.2			3.6					
46.0	9.5	9.3		7.5	7.5		5.2			3.6					
48.0	9.4	8.9		7.4	7.5		5.2	5.3		3.6					
50.0	9.4	8.5		7.4	7.4		5.2	5.2		3.5					
54.0	9.3	7.9		7.3	6.7		5.2	4.8		3.5	3.0				
58.0	9.0	7.3		7.0	5.9		5.1	4.2		3.4	2.5				
62.0	8.4	6.8	5.4	6.4	5.3	4.4	4.7	3.6	2.7	3.0	2.1				
66.0	7.9	6.3	5.0	5.8	4.7	3.9	4.2	3.1	2.3		1.7				
70.0		5.8	4.3		4.2	3.4		2.7	1.9						
74.0		5.3	3.6		3.8	2.8		2.4	1.6						
78.0			3.1			2.2									

Tragfähigkeiten
Lifting capacities
Capacités de levage
Capacidades de elevación





138t

DIN/ISO/EN

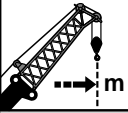
 m	15.0 m + 2.5 m + 70.0 m			20.1 m + 2.5 m + 70.0 m			25.1 m + 2.5 m + 70.0 m			30.2 m + 2.5 m + 70.0 m			35.3 m + 2.5 m + 70.0 m		
	83°	75°	68°	83°	75°	68°	83°	75°	68°	83°	75°	68°	83°	75°	68°
26.0	15.9														
28.0	15.7			14.8			13.8								
30.0	15.5			14.6			13.6								
32.0	15.4			14.5			13.5			12.2			10.6		
34.0	15.2			14.3			13.4			12.1			10.5		
36.0	14.9			14.1			13.3			12.0			10.4		
38.0	14.6	14.9		13.9			13.1			11.9			10.4		
40.0	14.2	14.6		13.6	13.7		12.9	13.1		11.8			10.3		
42.0	13.6	14.1		13.3	13.1		12.7	12.8		11.7			10.2		
44.0	13.1	13.7		12.8	12.7		12.4	12.2		11.6	11.1		10.1		
46.0	12.5	13.1	13.1	12.4	12.2		12.1	11.8		11.5	10.7		10.1	9.3	
48.0	12.0	12.6	12.7	12.0	11.8		11.7	11.3		11.3	10.3		10.0	8.9	
50.0	11.6	12.1	12.3	11.6	11.4	10.8	11.4	10.9		11.1	9.9		9.9	8.6	
54.0	10.7	11.2	11.5	10.7	10.7	10.1	10.7	10.1	9.3	10.5	9.2		9.5	7.9	
58.0	9.9	10.4	10.8	10.0	10.0	9.4	10.0	9.5	8.6	9.8	8.5	7.5	8.8	7.3	6.1
62.0	9.3	9.7	10.0	9.3	9.5	8.9	9.4	8.9	8.0	9.2	7.9	6.9	8.3	6.8	5.7
66.0	7.9	9.0	9.3	8.7	9.0	8.4	8.8	8.3	7.5	8.7	7.4	6.4	7.8	6.4	5.2
70.0		8.2	8.7		8.6	7.7	7.7	7.9	6.8	8.2	7.0	5.8	7.4	5.9	4.7
74.0						6.9		7.1	6.0		6.4	5.1		5.5	4.0
78.0												4.4		4.8	3.4
82.0															2.9





138t

DIN/ISO/EN

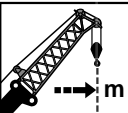
 m	40.4 m + 2.5 m + 70.0 m			45.4 m + 2.5 m + 70.0 m			50.5 m + 2.5 m + 70.0 m								
	83°	75°	68°	83°	75°	68°	83°	75°	68°						
32.0	8.4			6.4			4.5								
34.0	8.4			6.3			4.5								
36.0	8.3			6.3			4.5								
38.0	8.3			6.2			4.5								
40.0	8.2			6.2			4.4								
42.0	8.1			6.1			4.3								
44.0	8.1			6.1			4.3								
46.0	8.0			6.1			4.3								
48.0	8.0	7.7		6.1	6.1		4.2								
50.0	8.0	7.4		6.1	6.1		4.2								
54.0	7.9	6.8		6.0	6.1		4.1	4.2							
58.0	7.9	6.3		6.0	5.7		4.0	3.9							
62.0	7.4	5.8	4.5	6.0	5.1	4.0	4.0	3.4							
66.0	7.0	5.4	4.1	5.6	4.5	3.6	4.0	2.9	2.0						
70.0	6.6	5.0	3.7		4.0	3.2		2.5	1.6						
74.0		4.7	3.4		3.6	2.8		2.1							
78.0		4.4	3.0			2.4									
82.0			2.5			2.0									

MB + LJ

Tragfähigkeiten
Lifting capacities
Capacités de levage
Capacidades de elevación





138t

DIN/ISO/EN

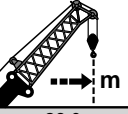
 m	15.0 m + 2.5 m + 76.0 m			20.1 m + 2.5 m + 76.0 m			25.1 m + 2.5 m + 76.0 m			30.2 m + 2.5 m + 76.0 m			35.3 m + 2.5 m + 76.0 m		
	83°	75°	68°	83°	75°	68°	83°	75°	68°	83°	75°	68°	83°	75°	68°
28.0	12.8														
30.0	12.7														
32.0	12.5			12.0			11.4			10.3			9.0		
34.0	12.2			11.7			11.2			10.2			8.9		
36.0	11.9			11.4			10.9			10.1			8.8		
38.0	11.5			11.1			10.7			10.0			8.8		
40.0	11.1	11.6		10.8			10.4			9.9			8.7		
42.0	10.6	11.1		10.4			10.1			9.7			8.6		
44.0	10.2	10.7		10.1	10.5		9.8			9.5			8.6		
46.0	9.8	10.3		9.7	10.2		9.5	10.0		9.2	9.0		8.5	7.7	
48.0	9.4	9.9		9.4	9.8		9.2	9.6		9.0	8.6		8.4	7.3	
50.0	9.1	9.5	9.9	9.0	9.5		8.9	9.3		8.7	8.3		8.2	7.0	
54.0	8.4	8.8	9.1	8.4	8.8		8.3	8.6		8.2	7.7		7.9	6.5	
58.0	7.8	8.1	8.4	7.8	8.2	8.0	7.8	8.1		7.7	7.1	6.1	7.5	6.0	
62.0	7.2	7.5	7.8	7.3	7.7	7.5	7.3	7.5	6.7	7.3	6.6	5.6	7.0	5.5	4.4
66.0	6.7	7.0	7.3	6.8	7.1	7.1	6.8	7.1	6.2	6.8	6.2	5.2	6.6	5.1	4.0
70.0	6.3	6.6	6.8	6.3	6.7	6.7	6.4	6.7	5.8	6.4	5.8	4.8	6.2	4.8	3.6
74.0	5.5	6.1	6.3	5.9	6.2	6.1	6.0	6.3	5.2	6.0	5.4	4.2	4.5	3.3	
78.0			5.9		5.9	5.4		5.6	4.5		4.8	3.6		4.2	3.1
82.0								3.9			4.2	3.0			2.5





138t

DIN/ISO/EN

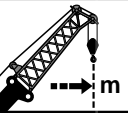
 m	40.4 m + 2.5 m + 76.0 m			45.4 m + 2.5 m + 76.0 m										
	83°	75°	68°	83°	75°	68°								
32.0	7.0			5.2										
34.0	7.0			5.1										
36.0	6.9			5.1										
38.0	6.9			5.0										
40.0	6.8			5.0										
42.0	6.8			5.0										
44.0	6.7			5.0										
46.0	6.7			5.0										
48.0	6.7	6.4		4.9										
50.0	6.6	6.2		4.9										
54.0	6.5	5.6		4.8	4.9									
58.0	6.5	5.2		4.7	4.7									
62.0	6.4	4.8	3.5	4.7	4.5									
66.0	6.0	4.4	3.1	4.7	4.1	2.7								
70.0	5.6	4.0	2.7	4.7	3.7	2.2								
74.0		3.7	2.2		3.2	1.6								
78.0		3.3	1.7		2.9									

Tragfähigkeiten
Lifting capacities
Capacités de levage
Capacidades de elevación

78t

DIN/ISO/EN

 m	15.0 m + 2.5 m + 20.3 m			20.1 m + 2.5 m + 20.3 m			25.1 m + 2.5 m + 20.3 m			30.2 m + 2.5 m + 20.3 m			35.3 m + 2.5 m + 20.3 m		
	83°	75°	68°	83°	75°	68°	83°	75°	68°	83°	75°	68°	83°	75°	68°
12.0	74.4														
14.0	69.6			65.3			61.2								
16.0	58.5	56.5		56.8			53.3			50.2					
18.0	50.4	48.5		49.1	46.3		47.2			44.5			41.7		
20.0	42.2	42.4	41.0	42.9	40.5		41.7	38.4		40.0			37.4		
22.0		37.6	36.3		35.9		37.0	34.0		36.0	32.4		34.0		
24.0			32.9		32.2	30.5		30.6			29.2			26.8	
26.0						27.5		27.7			26.3			24.6	
28.0									25.3				21.1	22.4	
30.0									23.0				19.2		17.5
32.0															16.0

78t

DIN/ISO/EN

 m	40.4 m + 2.5 m + 20.3 m			45.4 m + 2.5 m + 20.3 m											
	83°	75°	68°	83°	75°	68°									
18.0	39.0														
20.0	35.1			30.7											
22.0	31.8			28.1											
24.0	29.1			24.1											
26.0		22.4													
28.0		20.6													
30.0		19.0													

MB + LJ

Tragfähigkeiten
Lifting capacities
Capacités de levage
Capacidades de elevación



	15.0 m + 2.5 m + 32.3 m			20.1 m + 2.5 m + 32.3 m			25.1 m + 2.5 m + 32.3 m			30.2 m + 2.5 m + 32.3 m			35.3 m + 2.5 m + 32.3 m		
	83°	75°	68°	83°	75°	68°	83°	75°	68°	83°	75°	68°	83°	75°	68°
12.0	61.2														
14.0	59.6			49.5			43.5								
16.0	54.6			47.9			42.6			38.1					
18.0	48.2			45.2			41.8			37.5			32.4		
20.0	42.4	40.7		40.4	37.8		37.8			35.5			31.9		
22.0	37.5	36.0		36.2	33.9		34.2	31.0		32.1			29.8		
24.0	33.5	32.1	30.9	32.4	30.2		31.2	28.2		29.2	25.6		27.1		
26.0	30.3	29.0	27.9	29.2	27.2	25.4	28.2	25.7		26.8	23.4		24.9		
28.0	27.6	26.3	25.3	26.6	24.7	23.0	25.6	23.2		24.7	21.5		22.9	19.1	
30.0	25.3	24.0	23.0	24.3	22.5	20.9	23.4	21.1	18.8	22.6	19.7		21.2	17.6	
32.0	20.4	22.0	21.3	22.3	20.6	19.1	21.4	19.3	17.1	20.7	18.0	15.4	19.7	16.3	
34.0		20.3	19.6		18.9	17.6	19.7	17.8	15.7	19.1	16.6	14.1	18.2	15.2	12.3
36.0			18.1			17.6		16.4	14.5		15.2	13.0		13.9	11.3
38.0						15.0			15.1		14.1	11.9		12.9	10.4
40.0									13.3			11.0		11.9	9.6
42.0									12.4			10.2			8.8
44.0															8.1



	40.4 m + 2.5 m + 32.3 m			45.4 m + 2.5 m + 32.3 m			50.5 m + 2.5 m + 32.3 m							
	83°	75°	68°	83°	75°	68°	83°	75°	68°					
20.0	22.5													
22.0	22.1			17.8			13.7							
24.0	21.7			17.7			13.7							
26.0	21.3			17.4			13.7							
28.0	21.0			17.1			13.5							
30.0	19.6	15.5		16.9			13.3							
32.0	18.2	14.3		16.1	12.6		13.2							
34.0	17.0	13.3		15.1	11.6		12.9	10.7						
36.0	15.9	12.4		14.2	10.8		11.8	10.0						
38.0		11.5	8.8		10.0			9.3						
40.0		10.6	8.0		9.3	6.5		8.6						
42.0		9.8	7.4		8.7	6.0		8.0						
44.0			6.8			5.6		7.5	4.7					
46.0			6.2			5.1			4.3					
48.0						4.7			4.0					
50.0									3.6					

Tragfähigkeiten
Lifting capacities
Capacités de levage
Capacidades de elevación



	15.0 m + 2.5 m + 34.0 m			20.1 m + 2.5 m + 34.0 m			25.1 m + 2.5 m + 34.0 m			30.2 m + 2.5 m + 34.0 m			35.3 m + 2.5 m + 34.0 m		
	83°	75°	68°	83°	75°	68°	83°	75°	68°	83°	75°	68°	83°	75°	68°
14.0	53.2			46.1											
16.0	48.3			45.0			40.1			35.7					
18.0	44.1			43.6			39.4			35.1					
20.0	40.6	40.5		39.7			37.1			34.6			30.0		
22.0	37.3	35.7		35.9	33.4		33.6			31.4			29.0		
24.0	33.4	31.9		32.2	30.0		30.5	27.6		28.6			26.4		
26.0	30.1	28.8	27.8	29.0	27.0		27.8	25.2		26.2	22.8		24.2		
28.0	27.4	26.1	25.0	26.4	24.4	22.7	25.3	22.8		24.1	20.9		22.3		
30.0	25.1	23.8	22.9	24.1	22.2	20.6	23.0	20.7	18.3	22.2	19.3		20.6		
32.0	23.0	21.8	21.0	22.0	20.3	18.9	21.1	18.9	16.7	20.3	17.6	15.0	19.1	15.7	
34.0		20.1	19.3	20.3	18.7	17.3	19.4	17.4	15.3	18.7	16.1	13.7	17.8	14.6	
36.0		18.6	17.8		17.3	16.0		16.0	14.1	17.3	14.9	12.5	16.4	13.5	
38.0			16.5		16.1	14.8		14.8	13.0		13.7	11.5		12.4	
40.0						13.7		13.7	12.0		12.7	10.7		11.5	9.1
42.0									11.1			9.8		10.6	8.4
44.0												9.1			7.8
46.0															7.1



	40.4 m + 2.5 m + 34.0 m			45.4 m + 2.5 m + 34.0 m			50.5 m + 2.5 m + 34.0 m			55.6 m + 2.5 m + 34.0 m					
	83°	75°	68°	83°	75°	68°	83°	75°	68°	83°	75°	68°			
20.0	21.3														
22.0	20.9			17.0											
24.0	20.5			16.5			13.0			9.2					
26.0	20.2			16.2			12.8			9.0					
28.0	19.9			16.1			12.7			8.7					
30.0	19.1	14.9		15.9			12.6			8.6					
32.0	17.7	13.8		15.8	12.0		12.6			8.5					
34.0	16.5	12.8		15.1	11.1		12.5	9.8		8.5					
36.0	15.4	11.9		14.1	10.2		11.9	9.1		8.5					
38.0	14.4	11.0	8.3	13.1	9.5		11.0	8.4		8.5	7.8				
40.0		10.2	7.6		8.8			7.8		8.1	7.2				
42.0		9.5	7.0		8.2	5.5		7.2			6.7				
44.0		8.7	6.4		7.6	5.1		6.7	4.0		6.2				
46.0			5.9			4.7		6.2	3.6		5.7				
48.0			5.4			4.3			3.3		5.3	2.6			
50.0						3.9			2.9			2.3			
54.0												1.8			

MB + LJ

Tragfähigkeiten
Lifting capacities
Capacités de levage
Capacidades de elevación

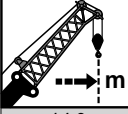

 m	15.0 m + 2.5 m + 40.0 m			20.1 m + 2.5 m + 40.0 m			25.1 m + 2.5 m + 40.0 m			30.2 m + 2.5 m + 40.0 m			35.3 m + 2.5 m + 40.0 m		
	83°	75°	68°	83°	75°	68°	83°	75°	68°	83°	75°	68°	83°	75°	68°
14.0	36.7														
16.0	33.2			33.2											
18.0	30.3			30.4			30.3								
20.0	27.5			28.0			28.2			20.6				21.8	
22.0	24.4	27.5		25.1			26.0			20.3				21.4	
24.0	22.1	24.3		22.3	26.0		23.1			19.8				21.0	
26.0	20.3	22.3		20.7	23.2		21.0	23.8		19.0				20.4	
28.0	18.8	20.6	22.2	19.2	21.4		19.5	21.9		18.0	19.5			19.6	
30.0	17.5	19.0	20.5	17.8	19.9		18.1	20.0		17.0	18.0			18.5	15.8
32.0	16.3	17.7	19.0	16.6	18.4	18.4	16.9	18.3		16.0	16.6			17.4	14.6
34.0	15.2	16.5	17.6	15.5	17.2	16.9	15.8	16.8	14.6	15.1	15.4			16.4	13.5
36.0	14.3	15.4	16.4	14.5	16.0	15.5	14.8	15.4	13.4	14.2	14.1	11.7		15.4	12.5
38.0	13.4	14.4	15.4	13.6	15.0	14.4	13.9	14.2	12.3	13.5	13.0	10.8		14.5	11.7
40.0		13.5	14.4	12.8	14.1	13.3	13.1	13.2	11.4	12.7	12.0	9.9		13.6	10.8
42.0		12.8	13.5		13.2	12.4		12.2	10.6	12.1	11.2	9.2		12.6	9.9
44.0					12.5	11.5		11.4	9.8		10.3	8.5			9.2
46.0						10.7			9.1		9.6	7.8			8.5
48.0									8.5			7.3			7.9
50.0												6.7			5.5

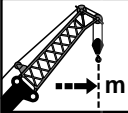

 m	40.4 m + 2.5 m + 40.0 m			45.4 m + 2.5 m + 40.0 m			50.5 m + 2.5 m + 40.0 m			55.6 m + 2.5 m + 40.0 m					
	83°	75°	68°	83°	75°	68°	83°	75°	68°	83°	75°	68°			
24.0	17.5			14.5											
26.0	17.0			14.3			11.7			9.4					
28.0	16.7			14.1			11.2			9.3					
30.0	16.4			14.1			10.9			9.2					
32.0	16.2			14.0			10.9			9.1					
34.0	15.0	11.3		13.9			10.9			8.9					
36.0	14.0	10.4		13.2	9.3		10.9			8.7					
38.0	13.1	9.7		12.3	8.6		10.7	7.6		8.4					
40.0	12.2	9.0		11.5	8.0		10.3	7.0		7.9	6.4				
42.0	11.4	8.4	5.9	10.8	7.4		9.7	6.5		7.4	5.9				
44.0	10.7	7.8	5.4	10.1	6.9		9.2	6.0		7.0	5.5				
46.0		7.3	5.0		6.4	3.9		5.5			5.1				
48.0		6.8	4.6		5.9	3.5		5.1	2.5		4.7				
50.0		6.2	4.2		5.5	3.2		4.7	2.2		4.3	1.6			
54.0			3.4			2.6			1.7		3.6				

Tragfähigkeiten
Lifting capacities
Capacités de levage
Capacidades de elevación



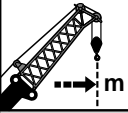

78t Light
DIN/ISO/EN

 m	15.0 m + 2.5 m + 46.0 m			20.1 m + 2.5 m + 46.0 m			25.1 m + 2.5 m + 46.0 m			30.2 m + 2.5 m + 46.0 m			35.3 m + 2.5 m + 46.0 m		
	83°	75°	68°	83°	75°	68°	83°	75°	68°	83°	75°	68°	83°	75°	68°
16.0	25.8														
18.0	22.8			23.1											
20.0	20.6			20.6			20.5								
22.0	18.9			19.0			19.1			18.9				18.2	
24.0	17.4	19.1		17.5			17.7			17.7				17.8	
26.0	16.0	17.6		16.2	18.1		16.4			16.5				16.9	
28.0	14.8	16.2		15.0	16.8		15.2			15.4				15.9	
30.0	13.8	15.0		13.9	15.6		14.2	16.1		14.4				15.0	
32.0	12.8	13.9	14.9	13.0	14.4		13.2	15.0		13.5	15.5			14.0	
34.0	12.0	12.9	13.8	12.1	13.5	14.7	12.4	14.0		12.6	14.5			13.2	12.4
36.0	11.2	12.1	12.9	11.4	12.5	13.6	11.6	13.1		11.8	13.5			12.4	11.5
38.0	10.5	11.3	12.0	10.7	11.7	12.8	10.9	12.2	11.9	11.1	12.4			11.6	10.7
40.0	9.8	10.6	11.3	10.0	11.0	11.9	10.2	11.4	11.0	10.4	11.4	9.3		10.9	10.0
42.0	9.3	9.9	10.6	9.4	10.3	11.2	9.6	10.8	10.2	9.8	10.6	8.6		10.3	9.3
44.0	8.7	9.4	9.9	8.9	9.7	10.5	9.1	10.1	9.4	9.2	9.8	7.9		9.7	8.7
46.0		8.8	9.3	8.4	9.2	9.9	8.6	9.5	8.8	8.7	9.1	7.3		9.1	8.1
48.0		8.3	8.8		8.6	9.3		9.0	8.1		8.5	6.7		8.6	7.5
50.0						8.8			7.6		7.9	6.2			6.9
54.0									6.6			5.3			6.0
58.0															3.5



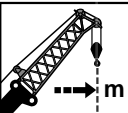

78t Light
DIN/ISO/EN

 m	40.4 m + 2.5 m + 46.0 m			45.4 m + 2.5 m + 46.0 m			50.5 m + 2.5 m + 46.0 m			55.6 m + 2.5 m + 46.0 m					
	83°	75°	68°	83°	75°	68°	83°	75°	68°	83°	75°	68°			
26.0	15.1			12.7			10.2								
28.0	14.8			12.6			10.1			7.8					
30.0	14.4			12.5			10.0			7.7					
32.0	13.8			12.4			9.8			7.6					
34.0	13.2			12.2			9.8			7.5					
36.0	12.6	9.5		11.9			9.7			7.4					
38.0	11.9	8.8		11.5	7.8		9.6			7.4					
40.0	11.3	8.2		10.8	7.2		9.5	6.7		7.3					
42.0	10.6	7.6		10.1	6.7		9.3	6.2		7.2					
44.0	10.0	7.0		9.4	6.2		9.0	5.7		6.8	4.6				
46.0	9.4	6.5	4.2	8.9	5.7		8.5	5.3		6.4	4.2				
48.0	8.8	6.1	3.9	8.3	5.3	2.9	8.1	4.9		6.1	3.9				
50.0		5.6	3.5	7.8	4.9	2.6	7.6	4.5		5.7	3.5				
54.0		4.9	2.9		4.2	2.0		3.8	1.5		2.9				
58.0			2.3			1.5		3.2			2.4				

MB + LJ

Tragfähigkeiten
Lifting capacities
Capacités de levage
Capacidades de elevación

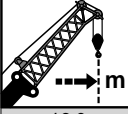

 m	15.0 m + 2.5 m + 46.0 m			20.1 m + 2.5 m + 46.0 m			25.1 m + 2.5 m + 46.0 m			30.2 m + 2.5 m + 46.0 m			35.3 m + 2.5 m + 46.0 m		
	83°	75°	68°	83°	75°	68°	83°	75°	68°	83°	75°	68°	83°	75°	68°
16.0	36.7														
18.0	35.8			30.8											
20.0	35.1			30.2			23.7								
22.0	34.3			29.7			23.2			18.5			17.9		
24.0	31.8			29.2			22.8			18.2			17.6		
26.0	28.8	27.3		27.0			22.4			17.9			17.4		
28.0	26.0	24.6		24.8	22.8		22.0			17.7			17.1		
30.0	23.6	22.3		22.5	20.7		21.1	18.5		17.4			16.9		
32.0	21.6	20.4	19.4	20.5	18.9		19.5	17.1		17.2	14.6		16.4		
34.0	19.9	18.7	17.8	18.8	17.3	15.6	17.9	15.7		16.3	13.5		15.2	11.8	
36.0	18.3	17.2	16.3	17.3	15.8	14.3	16.5	14.4		15.2	12.5		14.1	10.9	
38.0	16.9	15.9	15.1	16.0	14.6	13.1	15.2	13.3	11.3	14.0	11.5		13.2	10.1	
40.0	15.7	14.7	14.0	14.8	13.5	12.1	14.1	12.2	10.4	12.9	10.6	8.4	12.3	9.3	
42.0	14.6	13.7	12.9	13.8	12.5	11.2	13.1	11.3	9.6	12.0	9.7	7.7	11.5	8.7	6.3
44.0	13.7	12.7	12.0	12.9	11.7	10.4	12.2	10.5	8.8	11.1	9.0	7.0	10.8	8.1	5.8
46.0		11.9	11.2	12.0	10.9	9.6	11.3	9.7	8.2	10.4	8.3	6.4	10.0	7.5	5.3
48.0		11.2	10.5		10.1	8.9		9.0	7.5	9.7	7.7	5.9	9.3	6.9	4.9
50.0						8.3		8.4	7.0		7.1	5.4		6.4	4.4
54.0									6.0			4.5		5.4	3.6
58.0															3.0

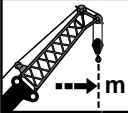

 m	40.4 m + 2.5 m + 46.0 m			45.4 m + 2.5 m + 46.0 m			50.5 m + 2.5 m + 46.0 m			55.6 m + 2.5 m + 46.0 m					
	83°	75°	68°	83°	75°	68°	83°	75°	68°	83°	75°	68°			
26.0	14.9			12.9			10.1			7.7					
28.0	14.8			12.8			10.0			7.5					
30.0	14.6			12.7			9.9			7.5					
32.0	14.4			12.5			9.8			7.4					
34.0	13.4			12.3			9.7			7.3					
36.0	12.5	8.9		11.6			9.6			7.2					
38.0	11.6	8.2		10.8	7.1		9.6			7.1					
40.0	10.8	7.5		10.1	6.5		9.5	6.1		6.9	4.3				
42.0	10.1	6.9		9.4	5.9		9.1	5.6		6.5	3.9				
44.0	9.4	6.4		8.7	5.4		8.7	5.1		6.1	3.5				
46.0	8.8	5.9	3.5	8.1	5.0		8.1	4.7		5.7	3.1				
48.0	8.2	5.4	3.2	7.6	4.6	2.1	7.6	4.3		5.4	2.8				
50.0		5.0	2.8	7.1	4.2	1.8	7.1	3.9		4.3	2.2				
54.0		4.2	2.2		3.5			3.2		2.2	1.6				
58.0			1.7					2.6							

Tragfähigkeiten
Lifting capacities
Capacités de levage
Capacidades de elevación

78t Light

DIN/ISO/EN

m	15.0 m + 2.5 m + 52.0 m			20.1 m + 2.5 m + 52.0 m			25.1 m + 2.5 m + 52.0 m			30.2 m + 2.5 m + 52.0 m			35.3 m + 2.5 m + 52.0 m		
	83°	75°	68°	83°	75°	68°	83°	75°	68°	83°	75°	68°	83°	75°	68°
18.0	18.8														
20.0	17.2			17.1											
22.0	15.8			15.8			15.8								
24.0	14.6			14.6			14.7			14.6					
26.0	13.5			13.5			13.7			13.7			13.9		
28.0	12.5	13.6		12.6			12.7			12.8			13.2		
30.0	11.6	12.6		11.7	13.0		11.9			12.0			12.5		
32.0	10.8	11.7		10.9	12.1		11.1	12.5		11.2			11.9		
34.0	10.1	10.8		10.2	11.3		10.3	11.6		10.5	12.0		11.2		
36.0	9.4	10.2	10.8	9.5	10.5		9.7	10.9		9.8	11.3		10.5		
38.0	8.8	9.5	10.1	8.9	9.8	10.7	9.1	10.2		9.2	10.6		9.9	9.5	
40.0	8.3	8.9	9.5	8.4	9.2	10.0	8.5	9.6	10.5	8.7	9.9		9.3	8.8	
42.0	7.8	8.3	8.9	7.9	8.6	9.3	8.0	9.0	9.6	8.2	9.3		8.7	8.2	
44.0	7.3	7.8	8.3	7.4	8.1	8.8	7.6	8.4	8.9	7.7	8.8	7.3	8.2	7.6	
46.0	6.9	7.4	7.8	7.0	7.6	8.2	7.1	7.9	8.2	7.3	8.2	6.7	7.8	7.1	4.9
48.0	6.5	7.0	7.4	6.6	7.2	7.8	6.7	7.5	7.6	6.9	7.8	6.2	7.3	6.6	4.5
50.0	6.2	6.6	6.9	6.3	6.8	7.3	6.4	7.1	7.1	6.5	7.3	5.7	6.9	6.1	4.1
54.0		5.9	6.2		6.1	6.5		6.3	6.1		6.4	4.8	6.2	5.2	3.4
58.0									5.3		5.5	4.1		4.4	2.8
62.0												3.4			2.2

78t Light

DIN/ISO/EN

m	40.4 m + 2.5 m + 52.0 m			45.4 m + 2.5 m + 52.0 m			50.5 m + 2.5 m + 52.0 m			55.6 m + 2.5 m + 52.0 m					
	83°	75°	68°	83°	75°	68°	83°	75°	68°	83°	75°	68°			
26.0	12.8														
28.0	12.5			10.8			8.5								
30.0	12.0			10.7			8.4								
32.0	11.5			10.4			8.3			6.1					
34.0	11.0			10.2			8.2			6.1					
36.0	10.4			9.8			8.1			6.0					
38.0	9.9			9.5			8.1			6.0					
40.0	9.4	7.3		9.1	6.7		8.0			5.9					
42.0	8.8	6.7		8.7	6.2		7.9			5.9					
44.0	8.4	6.2		8.3	5.7		7.7	4.6		5.9					
46.0	7.9	5.8		7.9	5.2		7.5	4.2		5.9	3.3				
48.0	7.5	5.3		7.6	4.8		7.1	3.8		5.8	3.0				
50.0	7.1	4.9	2.7	7.2	4.4		6.6	3.5		5.6	2.7				
54.0	6.3	4.2	2.2	6.5	3.8	1.5	5.8	2.8		5.0	2.1				
58.0		3.5	1.6		3.1			2.3		4.5	1.6				
62.0		3.0			2.6			1.8							
66.0															

MB + LJ

Tragfähigkeiten
Lifting capacities
Capacités de levage
Capacidades de elevación



	15.0 m + 2.5 m + 52.0 m			20.1 m + 2.5 m + 52.0 m			25.1 m + 2.5 m + 52.0 m			30.2 m + 2.5 m + 52.0 m			35.3 m + 2.5 m + 52.0 m			
	83°	75°	68°	83°	75°	68°	83°	75°	68°	83°	75°	68°	83°	75°	68°	
18.0	29.8															
20.0	29.2			22.3												
22.0	27.8			21.9			19.6									
24.0	25.4			21.5			19.3			14.8				16.0		
26.0	23.5			21.1			18.9			14.7				15.9		
28.0	22.2	24.0		20.7			18.6			14.6				15.7		
30.0	21.0	21.8		20.4	19.8		18.4			14.5				15.6		
32.0	19.8	19.8		19.5	18.2		18.1	15.9		14.5				15.2		
34.0	18.8	18.1		18.3	16.6		17.0	14.7		14.4	12.7			14.1		
36.0	17.8	16.7	15.7	16.8	15.2		15.8	13.6		14.3	11.7			13.1	9.8	
38.0	16.5	15.4	14.5	15.5	14.0	12.4	14.7	12.6		13.4	10.8			12.1	9.0	
40.0	15.2	14.2	13.4	14.3	12.9	11.5	13.5	11.6	9.7	12.5	10.0			11.3	8.3	
42.0	14.2	13.2	12.4	13.3	12.0	10.6	12.5	10.7	8.9	11.7	9.3			10.5	7.7	
44.0	13.2	12.2	11.5	12.3	11.1	9.8	11.6	9.9	8.2	10.9	8.7	6.7		9.8	7.1	
46.0	12.3	11.4	10.7	11.5	10.3	9.0	10.8	9.2	7.5	10.1	8.0	6.1		9.2	6.6	4.4
48.0	11.5	10.7	10.0	10.7	9.6	8.4	10.1	8.5	6.9	9.4	7.4	5.5		8.6	6.1	4.0
50.0	10.8	10.0	9.3	10.0	8.9	7.8	9.4	7.9	6.4	8.8	6.8	5.1		8.1	5.6	3.6
54.0		8.9	8.1		7.8	6.7		6.8	5.4	7.7	5.8	4.2		7.0	4.8	2.9
58.0									4.6		4.9	3.5			4.0	2.3
62.0											2.8					1.8



	40.4 m + 2.5 m + 52.0 m			45.4 m + 2.5 m + 52.0 m			50.5 m + 2.5 m + 52.0 m			55.6 m + 2.5 m + 52.0 m					
	83°	75°	68°	83°	75°	68°	83°	75°	68°	83°	75°	68°			
26.0	13.8														
28.0	13.7			11.2			8.6								
30.0	13.6			11.1			8.5								
32.0	13.5			11.0			8.4			6.0					
34.0	12.4			10.9			8.3			6.0					
36.0	11.5			10.8			8.2			6.0					
38.0	10.7			10.4			8.2			6.0					
40.0	9.9	6.6		9.6	6.0		8.1			5.9					
42.0	9.2	6.0		8.9	5.5		8.0			5.8					
44.0	8.5	5.5		8.3	5.0		7.4	3.8		5.8					
46.0	8.0	5.0		7.7	4.5		6.9	3.5		5.8	2.7				
48.0	7.4	4.6		7.2	4.1		6.4	3.1		5.6	2.3				
50.0	6.9	4.2	2.0	6.7	3.7		5.9	2.7		5.3	2.0				
54.0	6.0	3.5		5.8	3.1		5.1	2.1		4.6	1.5				
58.0		2.8			2.5			1.6		3.9					
62.0		2.3			1.9										

Tragfähigkeiten
Lifting capacities
Capacités de levage
Capacidades de elevación



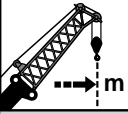

78t Light
DIN/ISO/EN

 m	15.0 m + 2.5 m + 58.0 m			20.1 m + 2.5 m + 58.0 m			25.1 m + 2.5 m + 58.0 m			30.2 m + 2.5 m + 58.0 m			35.3 m + 2.5 m + 58.0 m		
	83°	75°	68°	83°	75°	68°	83°	75°	68°	83°	75°	68°	83°	75°	68°
22.0	20.9			19.1											
24.0	19.9			18.8			16.8								
26.0	18.8			18.1			16.6			16.4			14.5		
28.0	17.6			17.3			16.3			16.1			14.4		
30.0	16.7			16.4			16.1			15.7			14.2		
32.0	15.7	16.8		15.6			15.4			15.3			14.1		
34.0	14.8	15.8		14.8	15.9		14.7			14.7			13.8		
36.0	14.0	15.0		14.0	14.7		14.0	12.6		13.7			12.8		
38.0	13.3	14.1		13.3	13.5		13.3	11.7		12.7	10.0		11.9	8.7	
40.0	12.6	13.4	12.8	12.7	12.4		12.7	10.9		11.8	9.2		11.1	8.1	
42.0	12.0	12.7	11.8	12.0	11.5	10.0	12.0	10.0		11.1	8.6		10.3	7.4	
44.0	11.4	11.8	10.9	11.5	10.6	9.3	11.1	9.2	7.5	10.3	7.9		9.6	6.9	
46.0	10.8	11.0	10.1	10.9	9.8	8.6	10.3	8.5	6.9	9.7	7.4		9.0	6.3	
48.0	10.3	10.3	9.4	10.4	9.1	7.9	9.6	7.9	6.3	9.0	6.8	5.0	8.4	5.8	
50.0	9.8	9.6	8.8	9.7	8.5	7.3	8.9	7.3	5.8	8.4	6.3	4.5	7.9	5.4	3.4
54.0	9.0	8.4	7.6	8.5	7.4	6.3	7.8	6.3	4.9	7.2	5.3	3.7	6.9	4.6	2.7
58.0		7.4	6.7		6.4	5.4	6.8	5.4	4.1	6.3	4.5	3.0	6.0	3.9	2.1
62.0						4.6			4.6	3.4		3.8	2.4	3.3	1.6
66.0												1.9		2.7	



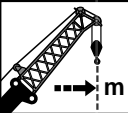

78t Light
DIN/ISO/EN

 m	40.4 m + 2.5 m + 58.0 m			45.4 m + 2.5 m + 58.0 m			50.5 m + 2.5 m + 58.0 m			55.6 m + 2.5 m + 58.0 m					
	83°	75°	68°	83°	75°	68°	83°	75°	68°	83°	75°	68°			
28.0	11.8														
30.0	11.7														
32.0	11.7			9.3			6.9			4.9					
34.0	11.6			9.3			6.9			4.9					
36.0	11.5			9.2			6.8			4.8					
38.0	10.9			9.1			6.7			4.8					
40.0	10.1	6.8		8.7			6.7			4.7					
42.0	9.4	6.2		8.1			6.7			4.6					
44.0	8.8	5.7		7.5			6.6			4.6					
46.0	8.2	5.2		7.0	3.7		6.3			4.6					
48.0	7.6	4.8		6.4	3.3		5.8	2.5		4.6	1.7				
50.0	7.1	4.4		6.0	3.0		5.4	2.1		4.6					
54.0	6.2	3.6	1.6	5.1	2.3		4.6	1.6		4.1					
58.0	5.4	3.0		4.4	1.8		3.9			3.4					
62.0		2.4		3.8			3.2			2.8					
66.0		1.9					2.7								

MB + LJ

Tragfähigkeiten
Lifting capacities
Capacités de levage
Capacidades de elevación

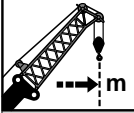

 m	15.0 m + 2.5 m + 58.0 m			20.1 m + 2.5 m + 58.0 m			25.1 m + 2.5 m + 58.0 m			30.2 m + 2.5 m + 58.0 m			35.3 m + 2.5 m + 58.0 m		
	83°	75°	68°	83°	75°	68°	83°	75°	68°	83°	75°	68°	83°	75°	68°
20.0	25.6														
22.0	23.9			19.9											
24.0	23.0			19.7			17.5								
26.0	22.6			19.4			17.3			16.7			14.6		
28.0	22.3			19.2			17.1			16.5			14.4		
30.0	22.0	20.7		19.0			16.9			16.3			14.3		
32.0	20.1	18.8		18.6	16.7		16.7			15.4			14.2		
34.0	18.4	17.1		17.2	15.4		15.5			14.2			13.2		
36.0	16.8	15.7		15.9	14.2		14.4	12.1		13.2			12.2		
38.0	15.5	14.4		14.6	13.0		13.3	11.2		12.1	9.5		11.3	8.1	
40.0	14.3	13.2	12.3	13.4	12.0		12.4	10.3		11.2	8.7		10.5	7.4	
42.0	13.2	12.2	11.4	12.4	11.0	9.6	11.5	9.6		10.4	8.0		9.7	6.8	
44.0	12.3	11.3	10.5	11.5	10.2	8.8	10.6	8.8	7.0	9.7	7.4		9.0	6.2	
46.0	11.4	10.5	9.7	10.6	9.4	8.1	9.8	8.1	6.4	9.1	6.8	4.9	8.4	5.7	
48.0	10.6	9.7	9.0	9.9	8.7	7.4	9.1	7.4	5.8	8.4	6.3	4.4	7.8	5.2	
50.0	9.9	9.1	8.3	9.2	8.0	6.9	8.4	6.8	5.3	7.9	5.8	4.0	7.2	4.8	2.7
54.0	8.6	8.0	7.2	8.0	6.9	5.8	7.3	5.8	4.4	6.8	4.9	3.2	6.3	4.0	2.0
58.0		6.9	6.2		5.9	4.9	6.3	4.9	3.6	5.8	4.0	2.5	5.4	3.2	1.5
62.0						4.1		4.1	2.9		3.3	1.9		2.6	
66.0														2.1	

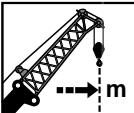

 m	40.4 m + 2.5 m + 58.0 m			45.4 m + 2.5 m + 58.0 m			50.5 m + 2.5 m + 58.0 m			55.6 m + 2.5 m + 58.0 m					
	83°	75°	68°	83°	75°	68°	83°	75°	68°	83°	75°	68°			
28.0	11.8														
30.0	11.7														
32.0	11.6			9.2			6.7			4.7					
34.0	11.5			9.1			6.6			4.6					
36.0	10.7			9.0			6.6			4.6					
38.0	9.9			8.7			6.6			4.6					
40.0	9.1			8.0			6.5			4.5					
42.0	8.4	5.2		7.4			6.5			4.4					
44.0	7.8	4.7		6.8			6.2			4.3					
46.0	7.2	4.2		6.3	3.0		5.6			4.3					
48.0	6.7	3.8		5.8	2.6		5.2	1.8		4.3					
50.0	6.2	3.4		5.3	2.3		4.7	1.5		4.3					
54.0	5.3	2.7		4.5	1.6		3.9			4.0					
58.0	4.5	2.1		3.7			3.2			3.3					
62.0		1.5		3.1			2.6			2.6					
66.0							2.1								

Tragfähigkeiten
Lifting capacities
Capacités de levage
Capacidades de elevación

78t Light

DIN/ISO/EN

 m	15.0 m + 2.5 m + 64.0 m			20.1 m + 2.5 m + 64.0 m			25.1 m + 2.5 m + 64.0 m			30.2 m + 2.5 m + 64.0 m			35.3 m + 2.5 m + 64.0 m		
	83°	75°	68°	83°	75°	68°	83°	75°	68°	83°	75°	68°	83°	75°	68°
24.0	16.5														
26.0	15.6			15.0			14.6								
28.0	14.8			14.4			14.1			13.4					
30.0	13.9			13.7			13.5			13.0					
32.0	13.1			13.0			12.9			12.5			11.7		
34.0	12.4	13.2		12.4			12.3			12.0			11.4		
36.0	11.7	12.5		11.7	12.7		11.7			11.6			11.0		
38.0	11.1	11.8		11.1	12.0		11.1	10.5		11.1			10.3		
40.0	10.5	11.2		10.5	11.4		10.6	9.7		10.6	8.6		9.5		
42.0	9.9	10.6	11.1	10.0	10.7		10.1	9.0		10.1	8.0		8.8		
44.0	9.4	10.0	10.4	9.5	9.9		9.6	8.3		9.6	7.3		8.2	5.4	
46.0	9.0	9.5	9.6	9.0	9.2	7.9	9.1	7.7		9.1	6.8		7.6	4.9	
48.0	8.5	9.0	8.9	8.6	8.5	7.2	8.7	7.2	5.6	8.5	6.3		7.0	4.4	
50.0	8.1	8.6	8.3	8.2	7.9	6.7	8.3	6.6	5.1	7.9	5.8	4.0	6.5	4.0	
54.0	7.4	7.8	7.2	7.5	6.7	5.7	7.3	5.6	4.2	6.9	4.9	3.3	5.6	3.3	
58.0	6.7	6.9	6.2	6.8	5.8	4.8	6.3	4.8	3.5	6.1	4.2	2.6	4.8	2.7	
62.0	6.2	6.0	5.4	6.1	5.0	4.1	5.5	4.0	2.8	5.3	3.5	2.1	4.1	2.1	
66.0			4.6		4.3	3.4		3.4	2.2		2.9	1.6	3.5	1.6	
70.0									1.7		2.4				

78t Light

DIN/ISO/EN

 m	40.4 m + 2.5 m + 64.0 m			45.4 m + 2.5 m + 64.0 m			50.5 m + 2.5 m + 64.0 m			55.6 m + 2.5 m + 64.0 m					
	83°	75°	68°	83°	75°	68°	83°	75°	68°	83°	75°	68°			
32.0	9.8			7.9			5.7			4.1					
34.0	9.8			7.8			5.7			4.0					
36.0	9.7			7.8			5.6			4.0					
38.0	9.3			7.7			5.5			3.9					
40.0	8.6			7.5			5.4			3.9					
42.0	8.0			6.9			5.4			3.9					
44.0	7.4			6.3			5.4			3.8					
46.0	6.8	3.8		5.8	2.5		5.4			3.8					
48.0	6.3	3.4		5.3	2.2		5.4	2.0		3.7					
50.0	5.8	3.1		4.9	1.9		5.0	1.6		3.7					
54.0	5.0	2.4		4.1			4.6			3.1					
58.0	4.2	1.8		3.4			3.8			2.5					
62.0	3.6			2.8			3.2			1.9					
66.0	3.0			2.3			2.6								

MB + LJ

Tragfähigkeiten
Lifting capacities
Capacités de levage
Capacidades de elevación

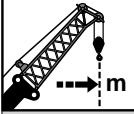

 m	15.0 m + 2.5 m + 64.0 m			20.1 m + 2.5 m + 64.0 m			25.1 m + 2.5 m + 64.0 m			30.2 m + 2.5 m + 64.0 m			35.3 m + 2.5 m + 64.0 m		
	83°	75°	68°	83°	75°	68°	83°	75°	68°	83°	75°	68°	83°	75°	68°
24.0	19.3			16.6											
26.0	19.1			16.4			15.8			14.7					
28.0	18.8			16.2			15.7			14.6			12.6		
30.0	18.6			16.0			15.5			14.4			12.5		
32.0	18.3			15.8			15.3			14.3			12.4		
34.0	17.8	16.6		15.7			14.4			13.6			11.9		
36.0	16.3	15.2		14.9	13.2		13.3			12.5			11.0		
38.0	14.9	13.9		13.8	12.2		12.3	10.1		11.5			10.1		
40.0	13.7	12.8		12.8	11.3		11.4	9.3		10.6	8.1		9.3		
42.0	12.7	11.8	10.7	11.9	10.4		10.6	8.6		9.9	7.4		8.6	5.7	
44.0	11.7	10.9	9.9	11.0	9.6		9.9	7.9		9.2	6.8		8.0	5.2	
46.0	10.9	10.1	9.1	10.2	8.8	7.5	9.2	7.3		8.5	6.2		7.4	4.7	
48.0	10.1	9.3	8.4	9.4	8.1	6.9	8.5	6.7	5.1	7.9	5.7		6.8	4.2	
50.0	9.4	8.6	7.7	8.7	7.5	6.3	8.0	6.2	4.7	7.3	5.2	3.4	6.3	3.8	
54.0	8.1	7.4	6.6	7.5	6.4	5.3	6.8	5.3	3.8	6.3	4.4	2.7	5.4	3.0	
58.0	7.1	6.4	5.6	6.5	5.4	4.4	5.8	4.4	3.1	5.5	3.6	2.0	4.6	2.4	
62.0	6.2	5.5	4.8	5.6	4.6	3.6	5.1	3.6	2.4	4.8	3.0	1.5	3.9	1.8	
66.0			4.1		3.9	3.0		3.0	1.8		2.4		3.2		
70.0											1.8				

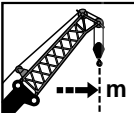

 m	40.4 m + 2.5 m + 64.0 m			45.4 m + 2.5 m + 64.0 m			50.5 m + 2.5 m + 64.0 m			55.6 m + 2.5 m + 64.0 m					
	83°	75°	68°	83°	75°	68°	83°	75°	68°	83°	75°	68°			
32.0	9.9			7.8			5.4			3.8					
34.0	9.9			7.8			5.3			3.8					
36.0	9.4			7.7			5.3			3.7					
38.0	8.7			7.4			5.2			3.7					
40.0	8.0			6.8			5.2			3.7					
42.0	7.3			6.2			5.2			3.6					
44.0	6.7			5.6			5.2			3.6					
46.0	6.2	3.2		5.1	1.8		5.2			3.6					
48.0	5.6	2.8		4.7	1.5		4.8			3.4					
50.0	5.2	2.4		4.2			4.4			3.0					
54.0	4.3	1.7		3.5			4.0			2.3					
58.0	3.6			2.8			3.2			1.7					
62.0	2.9			2.2			2.5								
66.0	2.4			1.6			2.0								

Tragfähigkeiten
Lifting capacities
Capacités de levage
Capacidades de elevación

78t

DIN/ISO/EN

 m	15.0 m + 2.5 m + 70.0 m			20.1 m + 2.5 m + 70.0 m			25.1 m + 2.5 m + 70.0 m			30.2 m + 2.5 m + 70.0 m			35.3 m + 2.5 m + 70.0 m		
	83°	75°	68°	83°	75°	68°	83°	75°	68°	83°	75°	68°	83°	75°	68°
26.0	15.9														
28.0	15.7			14.8			13.8								
30.0	15.5			14.6			13.6								
32.0	15.4			14.5			13.5			12.2			10.6		
34.0	15.2			14.3			13.4			12.1			10.5		
36.0	14.9			14.0			12.8			11.5			9.9		
38.0	14.6	13.4		12.9			11.8			10.6			9.1		
40.0	13.4	12.3		12.0	10.4		10.9	8.8		9.8			8.3		
42.0	12.3	11.3		11.2	9.6		10.1	8.1		9.0			7.6		
44.0	11.4	10.4		10.4	8.9		9.4	7.4		8.4	5.9		7.0		
46.0	10.6	9.6	8.7	9.6	8.2		8.7	6.8		7.7	5.4		6.5	3.7	
48.0	9.8	8.9	8.0	8.9	7.5		8.1	6.3		7.2	4.9		5.9	3.3	
50.0	9.1	8.2	7.3	8.2	6.9	5.7	7.5	5.8		6.6	4.4		5.4	2.9	
54.0	7.8	7.1	6.2	7.0	5.8	4.7	6.5	4.9	3.4	5.7	3.6		4.6	2.2	
58.0	6.8	6.0	5.3	6.0	4.9	3.9	5.6	4.1	2.7	4.8	2.9		3.8	1.6	
62.0	5.9	5.2	4.5	5.2	4.1	3.1	4.8	3.4	2.1	4.1	2.3		3.1		
66.0	5.1	4.4	3.8	4.5	3.4	2.5	4.1	2.7	1.6	3.5	1.7		2.5		
70.0		3.7	3.1		2.8	2.0	3.5	2.2		2.9			2.0		
74.0						1.5		1.6							

78t

DIN/ISO/EN

 m	40.4 m + 2.5 m + 70.0 m			45.4 m + 2.5 m + 70.0 m			50.5 m + 2.5 m + 70.0 m								
	83°	75°	68°	83°	75°	68°	83°	75°	68°						
32.0	8.4			6.4			4.5								
34.0	8.4			6.3			4.5								
36.0	8.3			6.3			4.5								
38.0	8.3			6.2			4.5								
40.0	7.6			6.2			4.4								
42.0	6.9			6.1			4.3								
44.0	6.3			5.8			4.3								
46.0	5.8			5.3			3.9								
48.0	5.3	2.2		4.8	1.5		3.5								
50.0	4.8	1.9		4.3			3.1								
54.0	4.3	1.5		3.9			2.4								
58.0	3.5			3.1			1.8								
62.0	2.9			2.5											
66.0	2.2			1.9											
70.0	1.7														

MB + LJ

Tragfähigkeiten
Lifting capacities
Capacités de levage
Capacidades de elevación



	15.0 m + 2.5 m + 76.0 m			20.1 m + 2.5 m + 76.0 m			25.1 m + 2.5 m + 76.0 m			30.2 m + 2.5 m + 76.0 m			35.3 m + 2.5 m + 76.0 m		
	83°	75°	68°	83°	75°	68°	83°	75°	68°	83°	75°	68°	83°	75°	68°
28.0	12.8														
30.0	12.7														
32.0	12.5			12.0			11.4			10.3			9.0		
34.0	12.2			11.7			11.2			10.2			8.9		
36.0	11.9			11.4			10.9			10.1			8.8		
38.0	11.5			11.1			10.6			9.3			8.4		
40.0	11.1	11.4		10.8			9.8			8.5			7.6		
42.0	10.6	10.4		10.2			9.1			7.8			6.9		
44.0	10.2	9.6		9.4	7.7		8.4			7.2			6.3		
46.0	9.8	8.8		8.7	7.1		7.7	5.7		6.6	4.2		5.7	2.9	
48.0	9.0	8.1		8.1	6.5		7.1	5.2		6.0	3.7		5.2	2.5	
50.0	8.4	7.4	6.5	7.5	6.0		6.6	4.7		5.5	3.3		4.7	2.1	
54.0	7.2	6.3	5.5	6.4	5.0		5.6	3.8		4.6	2.5		4.3	1.7	
58.0	6.1	5.3	4.6	5.4	4.1	3.1	4.7	3.1		3.8	1.9		3.4		
62.0	5.2	4.5	3.8	4.6	3.4	2.4	4.0	2.4		3.1			2.7		
66.0	4.6	3.8	3.1	3.8	2.7	1.8	3.3	1.9		2.5			2.1		
70.0	3.9	3.1	2.5	3.2	2.1		2.7			2.0			1.6		
74.0	3.3	2.5	1.9	2.6	1.6		2.2			1.5					
78.0			1.5												



	40.4 m + 2.5 m + 76.0 m			45.4 m + 2.5 m + 76.0 m											
	83°	75°	68°	83°	75°	68°									
32.0	7.0			5.2											
34.0	7.0			5.1											
36.0	6.9			5.1											
38.0	6.4			5.0											
40.0	5.8			5.0											
42.0	5.2			4.7											
44.0	4.7			4.2											
46.0	4.2			3.7											
48.0	3.7			3.3											
50.0	3.3			2.9											
54.0	2.6			2.2											
58.0	1.9			1.6											



**UNIVERSAL
SALE & RENTAL**

Hubhöhen
Lifting heights
Hauteurs de levage
Alturas de elevación

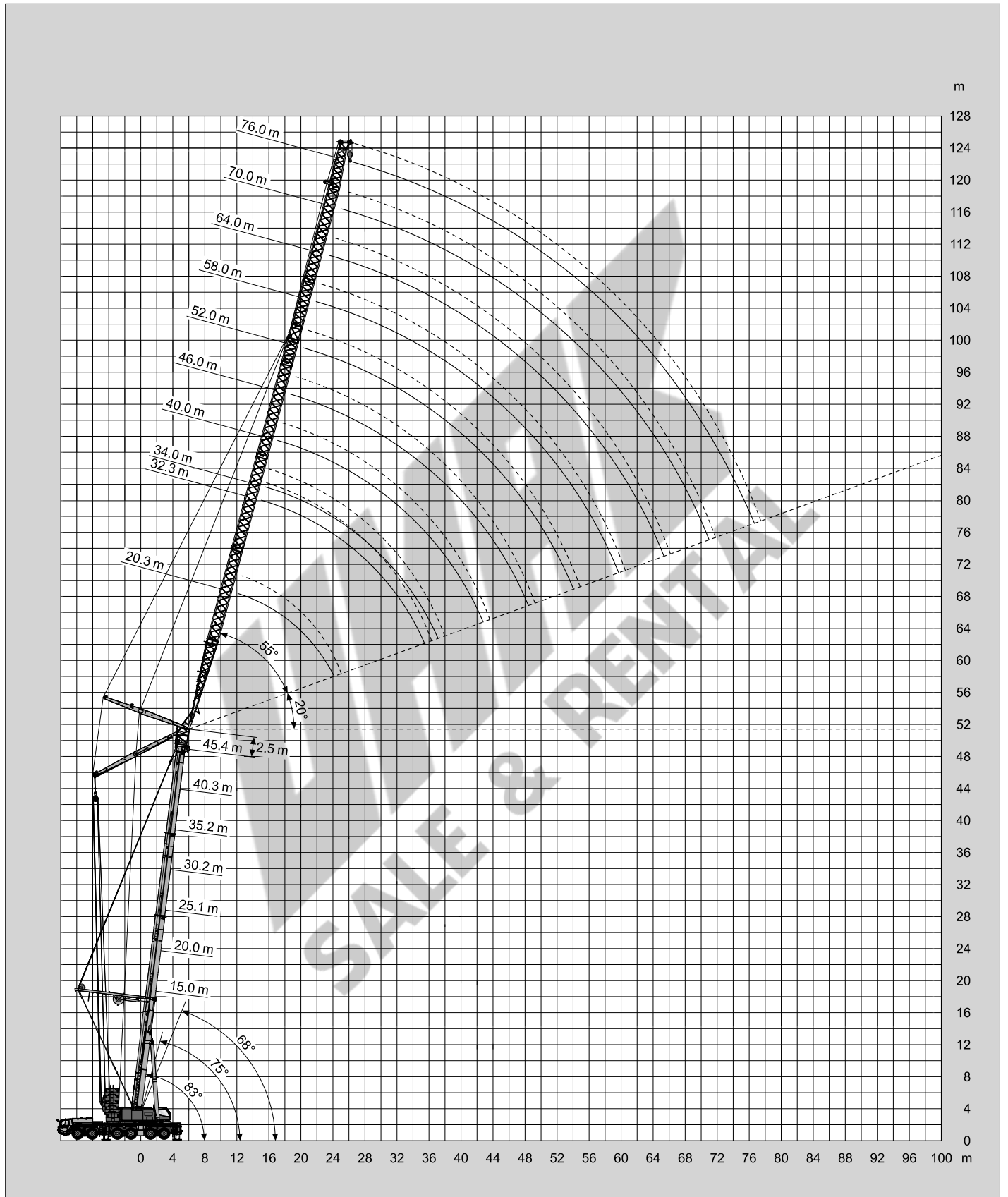

Tragfähigkeiten
Lifting capacities
Capacités de levage
Capacidades de elevación



	35.3 m + 2.5 m + 20.3 m			40.4 m + 2.5 m + 20.3 m			45.4 m + 2.5 m + 20.3 m								
	83°	75°	68°	83°	75°	68°	83°	75°	68°						
16.0	39.8														
18.0	35.5			31.1											
20.0	31.7			27.6			26.7								
22.0	28.0			22.0			21.5								
24.0		30.1		18.7			18.5								
26.0		27.2			21.4				20.8						
28.0		21.3			19.0										
30.0			22.8		16.5										
32.0			20.3			17.9									
34.0															
36.0															
38.0															
40.0															



	35.3 m + 2.5 m + 32.3 m			40.4 m + 2.5 m + 32.3 m			45.4 m + 2.5 m + 32.3 m			50.5 m + 2.5 m + 32.3 m					
	83°	75°	68°	83°	75°	68°	83°	75°	68°	83°	75°	68°			
18.0	30.8														
20.0	30.3			20.8											
22.0	29.4			20.3			16.5			12.5					
24.0	26.9			19.9			16.1			12.1					
26.0	22.4			19.0			15.8			11.9					
28.0	20.4	22.8		17.5			15.6			11.7					
30.0	18.6	20.9		16.0	17.7		15.3			11.6					
32.0	16.9	19.3		14.5	16.2		13.9	15.1		11.3					
34.0	15.2	17.8	19.2	13.1	15.0		12.5	14.2		11.0	11.5				
36.0		16.3	17.8		13.8		11.1	13.0		11.0	11.2				
38.0		14.9	16.5		12.6	13.7		12.0			10.9				
40.0		13.4	15.3		11.5	12.7		11.0	11.9		10.7				
42.0			14.1		10.3	11.7		9.9	11.0		10.2				
44.0			12.9			10.8			10.2		9.1	10.6			
46.0						9.9			9.4			9.4			
48.0									8.6			8.6			
50.0												7.9			
54.0															
58.0															

MB+LJ+PS

Tragfähigkeiten
Lifting capacities
Capacités de levage
Capacidades de elevación



m	35.3 m + 2.5 m + 34.0 m			40.4 m + 2.5 m + 34.0 m			45.4 m + 2.5 m + 34.0 m			50.5 m + 2.5 m + 34.0 m			55.6 m + 2.5 m + 34.0 m		
	83°	75°	68°	83°	75°	68°	83°	75°	68°	83°	75°	68°	83°	75°	68°
18.0	29.1														
20.0	28.5			19.8											
22.0	27.8			19.3			15.6								
24.0	24.4			18.9			15.2			11.5			7.9		
26.0	22.8			18.4			15.0			11.4			7.7		
28.0	21.2	23.5		17.6			14.7			11.4			7.7		
30.0	19.4	22.7		16.1	17.5		14.4			11.1			7.7		
32.0	17.7	21.2		14.6	16.3		13.8	14.4		11.0			7.7		
34.0	16.1	19.5		13.3	15.0		12.7	14.1		10.7	11.1		7.7		
36.0	14.6	18.0		12.0	13.8		11.4	13.2		10.6	10.8		7.5	7.2	
38.0		16.6	18.5		12.7	13.6	10.1	12.0		10.4	10.5		7.2	7.2	
40.0		15.3	17.5		11.7	12.6		11.0			10.5			7.0	
42.0		14.0	16.2		10.6	11.7		10.1	11.0		10.1			7.0	
44.0			15.0			10.8		9.1	10.1		9.3	10.3		7.0	
46.0			13.9			10.0			9.4		8.3	9.3		6.6	6.9
48.0						9.1			8.6			8.6		6.4	6.7
50.0									7.8			7.9			6.4
54.0															6.4



m	35.3 m + 2.5 m + 40.0 m			40.4 m + 2.5 m + 40.0 m			45.4 m + 2.5 m + 40.0 m			50.5 m + 2.5 m + 40.0 m			55.6 m + 2.5 m + 40.0 m		
	83°	75°	68°	83°	75°	68°	83°	75°	68°	83°	75°	68°	83°	75°	68°
20.0	20.8														
22.0	20.4			17.2											
24.0	20.0			16.8			13.4								
26.0	19.6			16.5			13.2			10.3			8.2		
28.0	18.7			16.2			13.1			10.3			8.0		
30.0	17.7	19.1		15.9			13.0			10.2			7.8		
32.0	16.7	18.8		15.6			12.8			10.0			7.7		
34.0	15.7	18.1		15.0	15.4		12.7			9.8			7.5		
36.0	14.8	17.0		14.1	15.0		12.4	12.6		9.7			7.3		
38.0	14.0	15.8		13.0	14.2		11.3	12.1		9.6	9.7		7.2	7.3	
40.0	12.9	14.7	15.7	11.9	13.2		10.3	11.4		9.4	9.5		7.0	7.1	
42.0	11.5	13.6	14.7	10.8	12.3	13.0	9.3	10.5		9.2	9.4		6.9	6.9	
44.0		12.6	13.7		11.5	12.2		9.7	10.2	8.5	9.2		6.7	6.8	
46.0		11.5	12.8		10.6	11.4		9.0	9.5		8.8			6.6	
48.0		10.4	11.9		9.8	10.7		8.3	8.9		8.3	8.8		6.5	
50.0			11.0			10.0		7.5	8.3		7.6	8.1		6.3	6.3
54.0									7.1			7.0		6.0	6.0
58.0												5.9			5.8

Tragfähigkeiten
Lifting capacities
Capacités de levage
Capacidades de elevación

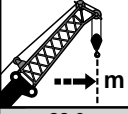

 m	35.3 m + 2.5 m + 46.0 m			40.4 m + 2.5 m + 46.0 m			45.4 m + 2.5 m + 46.0 m			50.5 m + 2.5 m + 46.0 m			55.6 m + 2.5 m + 46.0 m		
	83°	75°	68°	83°	75°	68°	83°	75°	68°	83°	75°	68°	83°	75°	68°
22.0	17.7														
24.0	17.1														
26.0	16.4			14.2			12.6			9.3					
28.0	15.5			13.9			12.5			9.1			6.8		
30.0	14.5			13.7			12.3			9.0			6.7		
32.0	13.7			13.2			12.1			8.8			6.5		
34.0	12.8	14.9		12.6			11.9			8.7			6.4		
36.0	12.0	14.1		12.0	13.3		11.5			8.6			6.3		
38.0	11.3	13.2		11.3	13.0		11.1	11.9		8.4			6.2		
40.0	10.7	12.4		10.7	12.3		10.6	11.7		8.3	8.4		6.1		
42.0	10.1	11.7	13.3	10.1	11.6		10.2	11.4		8.2	8.2		6.0	5.9	
44.0	9.5	11.0	12.5	9.6	10.8		9.7	10.8		8.1	8.1		5.9	5.8	
46.0	9.0	10.4	11.8	9.1	10.1	10.5	9.1	10.1		7.9	8.0		5.7	5.7	
48.0	8.5	9.8	11.1	8.3	9.4	9.8	8.4	9.4	9.8	7.7	7.8		5.6	5.6	
50.0		9.3	10.5		8.7	9.2		8.8	9.2	7.0	7.7	7.7	5.5	5.5	
54.0			9.3		7.4	8.1		7.6	8.2		6.8	7.1		5.3	5.2
58.0						7.0			7.2		5.6	6.2		5.0	5.0
62.0												5.3			4.8
66.0															4.4

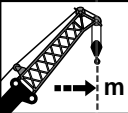

 m	35.3 m + 2.5 m + 46.0 m			40.4 m + 2.5 m + 46.0 m			45.4 m + 2.5 m + 46.0 m			50.5 m + 2.5 m + 46.0 m			55.6 m + 2.5 m + 46.0 m		
	83°	75°	68°	83°	75°	68°	83°	75°	68°	83°	75°	68°	83°	75°	68°
22.0	17.1														
24.0	16.8			14.0											
26.0	16.5			13.8			12.0			9.2					
28.0	16.2			13.7			11.8			9.0			6.6		
30.0	16.0			13.5			11.6			8.9			6.5		
32.0	15.7			13.3			11.5			8.7			6.3		
34.0	15.4	15.4		13.2			11.4			8.6			6.2		
36.0	14.8	15.2		13.0	13.1		11.2			8.5			6.1		
38.0	13.7	14.4		12.2	12.9		11.0	11.2		8.3			6.0		
40.0	12.7	13.5		11.3	12.0		10.6	10.9		8.2	8.2		5.9		
42.0	11.8	12.6	13.0	10.5	11.2		9.7	10.2		8.1	8.1		5.8	5.7	
44.0	10.9	11.8	12.2	9.6	10.4		8.9	9.5		7.9	7.9		5.7	5.6	
46.0	9.9	11.0	11.5	8.8	9.7	10.0	8.2	8.9		7.8	7.8		5.6	5.5	
48.0		10.2	10.7	8.0	9.0	9.4	7.5	8.3	8.5	7.5	7.7		5.5	5.4	
50.0		9.5	10.1		8.4	8.8		7.7	7.9	6.8	7.5	7.5	5.3	5.3	
54.0			8.8		7.1	7.7		6.6	6.9		6.5	6.7		5.0	5.0
58.0						6.6			6.0		5.4	5.8		4.8	4.8
62.0												5.0			4.6
66.0															4.2

MB+LJ+PS

Tragfähigkeiten
Lifting capacities
Capacités de levage
Capacidades de elevación



m	35.3 m + 2.5 m + 52.0 m			40.4 m + 2.5 m + 52.0 m			45.4 m + 2.5 m + 52.0 m			50.5 m + 2.5 m + 52.0 m			55.6 m + 2.5 m + 52.0 m		
	83°	75°	68°	83°	75°	68°	83°	75°	68°	83°	75°	68°	83°	75°	68°
26.0	14.0														
28.0	13.3			12.0			10.2			7.8					
30.0	12.7			11.6			10.1			7.6					
32.0	12.0			11.1			9.8			7.5			5.5		
34.0	11.4			10.5			9.6			7.4			5.4		
36.0	10.7			10.0			9.2			7.3			5.3		
38.0	10.1	11.7		9.5			8.9			7.2			5.2		
40.0	9.5	11.0		9.0	10.4		8.5	9.4		7.1			5.1		
42.0	9.0	10.4		8.5	9.9		8.2	9.2		7.1	7.0		5.1		
44.0	8.5	9.8		8.0	9.4		7.8	8.8		6.9	7.0		5.0		
46.0	8.0	9.3	10.5	7.6	8.9		7.4	8.5		6.7	6.9		4.9	4.8	
48.0	7.6	8.7	9.9	7.2	8.4		7.1	8.2		6.5	6.8		4.9	4.8	
50.0	7.2	8.3	9.3	6.8	8.0	8.9	6.8	7.8		6.3	6.7		4.8	4.7	
54.0		7.4	8.3	6.1	7.2	8.1	6.1	7.1	7.3	5.8	6.5	6.5	4.6	4.5	
58.0		6.7	7.5		6.4	7.2		6.2	6.4		6.0	6.2		4.4	
62.0			6.7			6.3		5.2	5.6		5.2	5.5		4.2	4.1
66.0									4.9			4.7		4.0	4.0
70.0															3.8



m	35.3 m + 2.5 m + 52.0 m			40.4 m + 2.5 m + 52.0 m			45.4 m + 2.5 m + 52.0 m			50.5 m + 2.5 m + 52.0 m			55.6 m + 2.5 m + 52.0 m		
	83°	75°	68°	83°	75°	68°	83°	75°	68°	83°	75°	68°	83°	75°	68°
24.0	15.5														
26.0	15.3														
28.0	15.1			12.9			10.5			7.8					
30.0	14.9			12.7			10.3			7.7					
32.0	14.8			12.6			10.2			7.5			5.4		
34.0	14.6			12.4			10.1			7.4			5.3		
36.0	14.5	14.5		12.3			10.0			7.3			5.2		
38.0	14.4	14.4		12.0			9.9			7.2			5.1		
40.0	14.1	14.2		11.7	11.8		9.7	9.8		7.1			5.0		
42.0	13.2	13.6		10.9	11.3		9.6	9.7		7.0	7.0		4.9		
44.0	12.3	13.1		10.1	10.6		9.4	9.4		7.0	6.9		4.9		
46.0	11.5	12.3	11.1	9.4	9.9		8.7	9.0		6.9	6.8		4.8	4.7	
48.0	10.6	11.6	10.6	8.7	9.3		8.1	8.4		6.8	6.7		4.7	4.6	
50.0	9.8	10.8	10.2	8.1	8.7	8.5	7.4	7.9		6.7	6.6		4.7	4.5	
54.0		9.5	9.4	6.7	7.6	7.8	6.2	6.8	7.0	6.3	6.4	6.4	4.5	4.4	
58.0		8.1	8.8		6.5	6.9		5.9	6.1		5.8	5.9		4.2	
62.0			7.7			6.0		5.0	5.3		4.9	5.1		4.0	3.9
66.0									4.6			4.4			3.8
70.0															3.6

Tragfähigkeiten
Lifting capacities
Capacités de levage
Capacidades de elevación

	35.3 m + 2.5 m + 58.0 m			40.4 m + 2.5 m + 58.0 m			45.4 m + 2.5 m + 58.0 m			50.5 m + 2.5 m + 58.0 m			55.6 m + 2.5 m + 58.0 m		
	83°	75°	68°	83°	75°	68°	83°	75°	68°	83°	75°	68°	83°	75°	68°
26.0	14.1														
28.0	13.9			11.3											
30.0	13.8			11.2											
32.0	13.6			11.1			8.7			6.4			4.4		
34.0	13.4			11.0			8.6			6.3			4.3		
36.0	13.1			10.8			8.5			6.2			4.2		
38.0	12.7	13.3		10.7			8.5			6.1			4.1		
40.0	12.2	13.0		10.6			8.4			6.1			4.1		
42.0	11.8	12.6		10.5	10.5		8.3			6.0			4.0		
44.0	11.4	12.1		10.3	10.4		8.2			5.9			4.0		
46.0	10.9	11.4		9.7	10.0		8.1	8.1		5.8	5.8		3.9		
48.0	10.3	10.7		9.0	9.3		8.1	8.0		5.8	5.7		3.9	3.7	
50.0	9.6	10.1	9.9	8.4	8.7		7.7	7.9		5.7	5.7		3.8	3.7	
54.0	8.4	8.9	9.1	7.3	7.7	7.7	6.7	6.9		5.6	5.5		3.7	3.6	
58.0	7.1	7.8	8.1	6.2	6.7	6.8	5.7	6.0		5.5	5.4	5.3	3.7	3.5	
62.0		6.8	7.1		5.8	6.0		5.2	5.3		5.1	4.8	3.5	3.4	3.2
66.0			6.3		4.9	5.3		4.5	4.6		4.4	4.4		3.3	3.2
70.0						4.6			4.0			3.8		3.2	3.0
74.0												3.2			2.9

	35.3 m + 2.5 m + 58.0 m			40.4 m + 2.5 m + 58.0 m			45.4 m + 2.5 m + 58.0 m			50.5 m + 2.5 m + 58.0 m			55.6 m + 2.5 m + 58.0 m		
	83°	75°	68°	83°	75°	68°	83°	75°	68°	83°	75°	68°	83°	75°	68°
26.0	14.1														
28.0	13.9			11.2											
30.0	13.8			11.1									4.1		
32.0	13.6			11.0			8.6			6.1			4.0		
34.0	13.4			10.8			8.5			6.0			3.9		
36.0	13.3			10.7			8.3			6.0			3.8		
38.0	13.2	13.2		10.6			8.3			5.9			3.8		
40.0	12.8	12.8		10.5			8.2			5.8			3.8		
42.0	12.1	12.3		10.2	10.3		8.1			5.7			3.7		
44.0	11.4	11.7		10.0	10.1		8.0			5.7			3.7		
46.0	10.7	11.0		9.3	9.5		7.9	7.9		5.6	5.5		3.6		
48.0	10.0	10.3	9.9	8.7	8.9		7.8	7.7		5.5	5.5		3.6	3.5	
50.0	9.3	9.7	9.4	8.1	8.3		7.4	7.6		5.5	5.4		3.6	3.4	
54.0	8.0	8.5	8.6	7.0	7.3	7.3	6.3	6.5		5.4	5.2		3.4	3.3	
58.0	6.8	7.5	7.7	5.9	6.4	6.5	5.4	5.7		5.2	5.1	4.8	3.4	3.2	
62.0		6.4	6.8		5.5	5.7		4.9	4.9		4.8	4.3	3.3	3.1	3.0
66.0			5.9		4.6	5.0		4.1	4.3		4.0	3.7		3.0	2.9
70.0						4.2			3.7			3.1		2.9	2.7
74.0												2.5			2.4

MB+LJ+PS

Tragfähigkeiten
Lifting capacities
Capacités de levage
Capacidades de elevación



Lifting height (m)	35.3 m + 2.5 m + 64.0 m			40.4 m + 2.5 m + 64.0 m			45.4 m + 2.5 m + 64.0 m			50.5 m + 2.5 m + 64.0 m			55.6 m + 2.5 m + 64.0 m		
	83°	75°	68°	83°	75°	68°	83°	75°	68°	83°	75°	68°	83°	75°	68°
28.0	12.3														
30.0	12.1														
32.0	11.7			9.5			7.4			5.2			3.5		
34.0	11.4			9.4			7.3			5.1			3.4		
36.0	11.0			9.3			7.3			5.0			3.3		
38.0	10.6			9.2			7.2			5.0			3.3		
40.0	10.2			9.0			7.1			5.0			3.2		
42.0	9.8	10.8		8.8			7.1			5.0			3.2		
44.0	9.4	10.4		8.6			7.0			4.9			3.2		
46.0	9.0	10.0		8.3	8.8		6.9	6.9		4.8			3.1		
48.0	8.6	9.6		8.1	8.7		6.9	6.8		4.8	4.7		3.1		
50.0	8.3	9.2		7.8	8.4		6.8	6.8		4.7	4.7		3.1	2.9	
54.0	7.6	8.5	7.9	7.3	7.7		6.6	6.7		4.7	4.6		2.9	2.8	
58.0	7.0	7.8	7.3	6.6	6.8		6.0	6.1		4.6	4.5		2.9	2.7	
62.0	6.4	7.1	6.7	5.6	6.0	5.6	5.1	5.3	4.6	4.6	4.4	3.9	2.9	2.7	
66.0		6.6	6.2	4.7	5.2	5.1	4.2	4.6	4.2		4.3	3.5	2.8	2.6	2.4
70.0		6.1	5.6		4.5	4.6		4.0	3.6		3.8	3.2		2.6	2.4
74.0			4.9			4.0		3.3	3.1			2.9		2.5	2.3
78.0								2.6	2.6			2.5			1.9



Lifting height (m)	35.3 m + 2.5 m + 64.0 m			40.4 m + 2.5 m + 64.0 m			45.4 m + 2.5 m + 64.0 m			50.5 m + 2.5 m + 64.0 m			55.6 m + 2.5 m + 64.0 m		
	83°	75°	68°	83°	75°	68°	83°	75°	68°	83°	75°	68°	83°	75°	68°
28.0	12.3														
30.0	12.1														
32.0	12.0			9.5			7.4			5.1			3.2		
34.0	11.9			9.4			7.3			5.0			3.1		
36.0	11.7			9.3			7.2			5.0			3.1		
38.0	11.6			9.2			7.1			4.9			3.0		
40.0	11.5			9.1			7.0			4.8			3.0		
42.0	11.4	11.5		9.0			7.0			4.8			2.9		
44.0	11.3	11.0		8.9			6.9			4.7			2.9		
46.0	11.2	10.5		8.8	8.9		6.8	6.8		4.7			2.9		
48.0	11.0	10.1		8.7	8.6		6.8	6.7		4.6	4.5		2.8		
50.0	10.3	9.7		8.3	8.2		6.7	6.7		4.6	4.5		2.8	2.6	
54.0	9.1	8.9	7.5	7.2	7.4		6.4	6.5		4.5	4.4		2.7	2.5	
58.0	7.9	8.3	6.9	6.3	6.5		5.7	5.7		4.4	4.3		2.6	2.5	
62.0	6.8	7.5	6.3	5.3	5.7	5.0	4.8	5.0	4.0	4.4	4.2	3.5	2.6	2.4	
66.0		6.5	5.8		4.9	4.6	4.0	4.3	3.6	4.0	4.1	3.1	2.6	2.3	2.2
70.0		5.6	5.0		4.2	3.9		3.6	3.0		3.5	2.8		2.3	2.1
74.0			4.3			3.3		3.0	2.4		2.9	2.4		2.3	1.7
78.0								1.9	1.9			1.9			

Tragfähigkeiten
Lifting capacities
Capacités de levage
Capacidades de elevación



	35.3 m + 2.5 m + 70.0 m			40.4 m + 2.5 m + 70.0 m			45.4 m + 2.5 m + 70.0 m			50.5 m + 2.5 m + 70.0 m					
	83°	75°	68°	83°	75°	68°	83°	75°	68°	83°	75°	68°			
32.0	10.3			8.1			6.1			4.1					
34.0	10.2			8.0			6.1			4.1					
36.0	10.1			8.0			6.0			3.9					
38.0	10.0			7.9			5.9			3.8					
40.0	9.9			7.8			5.8			3.8					
42.0	9.8			7.8			5.8			3.8					
44.0	9.7			7.7			5.8			3.8					
46.0	9.7	9.1		7.6	7.6		5.7			3.8					
48.0	9.6	8.7		7.6	7.4		5.6	5.6		3.7	3.5				
50.0	9.5	8.4		7.5	7.1		5.6	5.6		3.7	3.5				
54.0	9.1	7.7		7.1	6.5		5.5	5.5		3.6	3.5				
58.0	8.2	7.1	5.8	6.4	6.0		5.4	5.4		3.6	3.4				
62.0	7.1	6.6	5.3	5.5	5.5	4.1	5.0	4.9	3.5	3.5	3.3	2.6			
66.0	6.2	6.2	4.9	4.7	4.9	3.7	4.2	4.2	3.1	3.5	3.3	2.3			
70.0	5.2	5.7	4.3	4.3	4.3	3.4	3.5	3.6	2.8	3.3	3.3	1.7			
74.0		5.1	3.7		3.6	3.1		3.1	2.5		3.0				
78.0			3.1			2.6			2.0						
82.0									1.5						



	35.3 m + 2.5 m + 76.0 m			40.4 m + 2.5 m + 76.0 m			45.4 m + 2.5 m + 76.0 m								
	83°	75°	68°	83°	75°	68°	83°	75°	68°						
32.0	8.7			6.7			4.9								
34.0	8.6			6.7			4.8								
36.0	8.6			6.6			4.8								
38.0	8.5			6.5			4.8								
40.0	8.4			6.5			4.8								
42.0	8.3			6.4			4.7								
44.0	8.3			6.4			4.7								
46.0	8.2	7.4		6.3			4.6								
48.0	8.1	7.1		6.3	6.2		4.6	4.5							
50.0	8.0	6.8		6.3	5.9		4.6	4.5							
54.0	7.7	6.3		6.2	5.4		4.5	4.4							
58.0	7.3	5.8		6.0	4.9		4.4	4.4							
62.0	6.9	5.3	4.0	5.4	4.5	3.1	4.3	4.1	2.5						
66.0	6.2	4.9	3.7	4.7	4.1	2.7	4.1	3.7	2.1						
70.0	5.4	4.6	3.3	4.0	3.8	2.3	3.5	3.4	1.6						
74.0	4.6	4.2	3.0		3.5	1.8		3.0							
78.0		4.0	2.7		3.0			2.5							
82.0			2.2												

MB+LJ+PS

HTLJ / Hubhöhen
 HTLJ / Lifting heights
 HTLJ / Hauteurs de levage
 HTLJ / Alturas de elevación

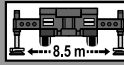
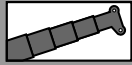

118t

DIN/ISO/EN

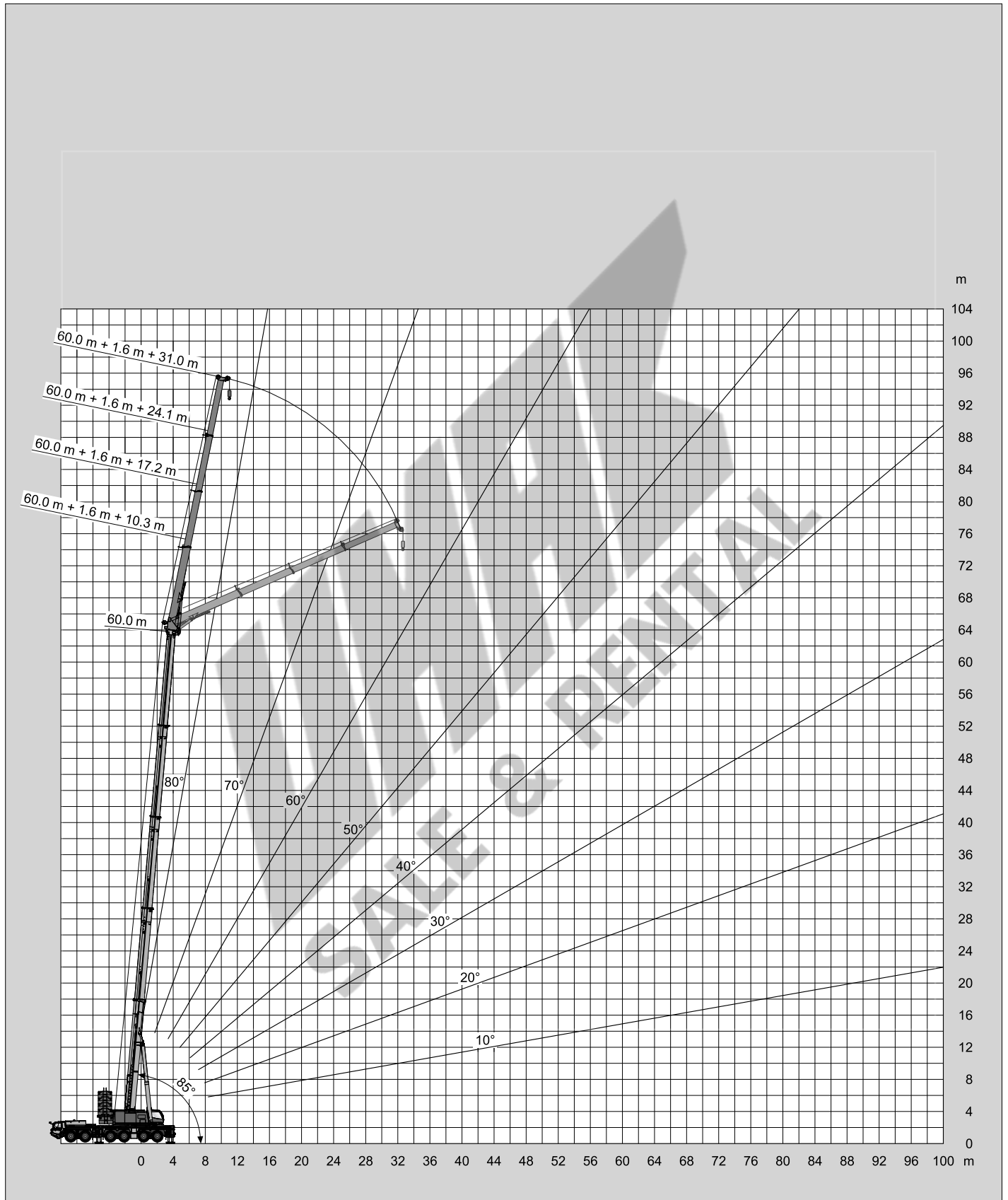

HTLJ / Tragfähigkeiten
 HTLJ / Lifting capacities
 HTLJ / Capacités de levage
 HTLJ / Capacidades de elevación

118t

DIN/ISO/EN

m	40.4 m + 1.6 m + 10.3 m					40.4 m + 1.6 m + 17.2 m					40.4 m + 1.6 m + 24.1 m					40.4 m + 1.6 m + 31.0 m				
	5°	15°	30°	45°	60°	5°	15°	30°	45°	60°	5°	15°	30°	45°	60°	5°	15°	30°	45°	60°
9.0	39.9																			
10.0	37.4					16.7														
11.0	35.2	33.2				16.7														
12.0	33.3	31.5				16.7														
14.0	29.9	28.4	26.8			16.7	16.7				16.1									
16.0	27.0	25.9	24.5	23.6	22.7	16.7	16.7				15.6					10.9				
18.0	24.6	23.7	22.6	21.8	21.3	16.7	16.7	16.7			15.2	13.8				10.8				
20.0	22.6	21.8	20.9	20.2	19.8	16.7	16.7	16.7			14.7	13.3				10.6				
22.0	20.8	20.2	19.4	18.9	18.5	16.7	16.7	16.7	14.4		14.2	12.8				10.3	9.4			
24.0	19.3	18.7	18.1	17.6	17.4	16.7	16.7	16.2	14.0	12.9	13.7	12.4				10.1	9.0			
26.0	16.8	17.2	16.9	16.5	16.3	16.7	16.1	15.4	13.7	12.7	13.2	12.0	10.8			9.8	8.6			
28.0	14.7	15.0	15.3	15.4	15.4	15.6	15.0	14.4	13.3	12.5	12.8	11.7	10.4			9.4	8.3			
30.0	12.7	13.0	13.4	13.6		14.0	14.1	13.6	13.0	12.4	12.4	11.4	10.1	9.3		9.0	7.9	6.9		
32.0	11.1	11.3	11.7	11.8		12.4	12.7	12.8	12.5	12.3	12.0	11.1	9.8	9.1	8.4	8.6	7.6	6.6		
34.0	9.6	9.8	10.1	10.2		10.9	11.3	11.7	11.8	11.7	11.6	10.7	9.5	8.9	8.2	8.3	7.4	6.4		
36.0	8.2	8.5	8.7	8.8		9.6	10.0	10.4	10.7		10.4	10.4	9.3	8.7	8.1	8.0	7.1	6.2	5.7	
38.0	7.0	7.2	7.4			8.4	8.8	9.2	9.5		9.3	9.7	9.1	8.5	8.1	7.7	6.9	6.0	5.5	
40.0	5.9	6.1	6.3			7.4	7.7	8.2	8.4		8.3	8.7	8.9	8.3		7.4	6.6	5.9	5.4	5.1
42.0	5.0	5.1	5.2			6.4	6.7	7.1	7.3		7.3	7.7	8.2	8.2		7.1	6.4	5.7	5.3	5.1
44.0	4.1	4.2	4.2			5.5	5.8	6.1	6.2		6.5	6.9	7.3	7.6		6.9	6.2	5.6	5.2	5.0
46.0	3.2	3.3				4.7	4.9	5.2			5.7	6.1	6.5	6.8		6.6	6.0	5.4	5.1	5.0
48.0	2.5	2.5				3.9	4.2	4.4			4.9	5.3	5.8	6.0		5.9	5.9	5.3	5.0	
50.0						3.2	3.4	3.6			4.3	4.6	5.0			5.3	5.7	5.2	4.9	
54.0						2.0	2.1				3.0	3.3	3.6			4.0	4.5	4.9	4.7	
58.0											2.0	2.2				3.0	3.3	3.8		
62.0																2.1	2.3	2.6		

118t

DIN/ISO/EN

m	45.4 m + 1.6 m + 10.3 m					45.4 m + 1.6 m + 17.2 m					45.4 m + 1.6 m + 24.1 m					45.4 m + 1.6 m + 31.0 m				
	5°	15°	30°	45°	60°	5°	15°	30°	45°	60°	5°	15°	30°	45°	60°	5°	15°	30°	45°	60°
10.0	29.6																			
11.0	28.4					16.7														
12.0	26.9	25.0				16.7														
14.0	24.2	22.7				16.7														
16.0	22.0	20.8	19.4	18.4		16.7	16.7				14.8					10.4				
18.0	20.2	19.1	17.9	17.1	16.6	16.7	16.7				14.4					10.2				
20.0	18.6	17.7	16.6	16.0	15.5	16.7	15.8	14.6			14.1	13.0				10.0				
22.0	17.2	16.4	15.5	14.9	14.6	15.7	14.7	13.7			13.7	12.6				9.8				
24.0	15.9	15.3	14.5	14.0	13.7	14.5	13.7	12.8	12.2	11.8	13.4	12.2				9.6	8.8			
26.0	14.9	14.3	13.6	13.2	13.0	13.5	12.8	12.0	11.5	11.1	12.5	11.7				9.4	8.5			
28.0	13.6	13.4	12.8	12.4	12.3	12.7	12.0	11.3	10.8	10.5	11.7	11.0	10.2			9.3	8.1			
30.0	11.8	12.0	12.1	11.8	11.6	11.9	11.3	10.7	10.2	10.0	10.9	10.3	9.7			8.9	7.8			
32.0	10.2	10.5	10.7	10.9		11.1	10.6	10.1	9.7	9.5	10.3	9.7	9.1	8.7		8.6	7.6	6.5		
34.0	8.8	9.0	9.3	9.5		9.9	10.0	9.5	9.2	9.1	9.7	9.2	8.6	8.3	8.1	8.2	7.3	6.3		
36.0	7.4	7.7	8.0	8.1		8.7	9.1	9.0	8.8	8.6	9.1	8.7	8.2	7.9	7.7	7.9	7.0	6.2	5.6	
38.0	6.3	6.5	6.8	6.9		7.6	8.0	8.4	8.3	8.2	8.3	8.2	7.8	7.5	7.3	7.6	6.8	6.0	5.5	
40.0	5.2	5.4	5.7	5.7		6.6	6.9	7.4	7.6		7.4	7.7	7.3	7.0	6.9	7.4	6.6	5.8	5.4	5.1
42.0	4.2	4.4	4.6			5.7	6.0	6.4	6.6		6.5	6.9	6.8	6.6		7.1	6.4	5.7	5.2	5.1
44.0	3.3	3.5	3.7			4.8	5.1	5.5	5.7		5.7	6.1	6.3	6.1		6.5	6.2	5.5	5.1	5.0
46.0	2.5	2.7	2.8			4.0	4.3	4.7	4.8		4.9	5.3	5.7	5.7		5.8	6.0	5.4	5.0	4.9
48.0						3.2	3.5	3.9	4.0		4.2	4.6	5.1	5.3		5.1	5.5	5.2	4.9	4.9
50.0						2.6	2.8	3.1			3.6	4.0	4.4	4.7		4.5	4.9	5.0	4.8	
54.0											2.4	2.7	3.1			3.4	3.8	4.2	4.2	
58.0													1.9			2.4	2.7	3.2	3.5	
62.0																1.8	2.2			

MB + HTLJ

HTLJ / Tragfähigkeiten
 HTLJ / Lifting capacities
 HTLJ / Capacités de levage
 HTLJ / Capacidades de elevación





118t

DIN/ISO/EN

m	50.5 m + 1.6 m + 10.3 m					50.5 m + 1.6 m + 17.2 m					50.5 m + 1.6 m + 24.1 m					50.5 m + 1.6 m + 31.0 m				
	5°	15°	30°	45°	60°	5°	15°	30°	45°	60°	5°	15°	30°	45°	60°	5°	15°	30°	45°	60°
11.0	20.8																			
12.0	19.8																			
14.0	18.0	16.3				15.8														
16.0	16.5	15.1	13.5			14.4	12.8				12.8									
18.0	15.0	14.0	12.7	11.8	11.2	13.3	11.9				11.8					9.1				
20.0	13.7	13.0	11.9	11.1	10.6	12.3	11.1				10.9	9.7				9.1				
22.0	12.6	12.1	11.2	10.5	10.1	11.4	10.4	9.2			10.1	9.0				9.1				
24.0	11.6	11.1	10.5	10.0	9.6	10.7	9.7	8.7	8.0		9.5	8.5				8.8				
26.0	10.7	10.3	9.9	9.5	9.2	10.0	9.1	8.2	7.6	7.2	8.8	8.0	7.0			8.2	7.4			
28.0	9.9	9.6	9.2	9.0	8.8	9.3	8.6	7.8	7.3	6.9	8.3	7.5	6.7			7.7	6.9			
30.0	8.9	8.7	8.4	8.2	8.0	8.6	8.2	7.4	6.9	6.6	7.8	7.1	6.3			7.3	6.5			
32.0	8.0	7.8	7.5	7.4	7.3	7.8	7.6	7.0	6.6	6.4	7.4	6.7	6.0	5.5		6.8	6.2	5.5		
34.0	7.2	7.0	6.8	6.7		7.1	6.9	6.6	6.3	6.1	6.8	6.4	5.7	5.3	5.0	6.5	5.9	5.2		
36.0	6.4	6.3	6.1	6.0		6.4	6.2	6.0	5.9	5.7	6.1	6.0	5.4	5.1	4.8	6.1	5.5	5.0		
38.0	5.8	5.6	5.5	5.4		5.7	5.6	5.4	5.3	5.2	5.5	5.4	5.2	4.8	4.5	5.7	5.3	4.7	4.3	
40.0	4.8	5.0	4.9	4.9		5.1	5.0	4.9	4.8	4.7	5.0	4.9	4.8	4.5	4.3	5.2	5.0	4.4	4.0	
42.0	3.9	4.1	4.3	4.3		4.6	4.5	4.4	4.3		4.5	4.4	4.3	4.2	4.0	4.7	4.6	4.2	3.8	3.5
44.0	3.0	3.2	3.4	3.5		4.1	4.0	4.0	3.9		4.0	4.0	3.9	3.9		4.2	4.2	3.9	3.5	3.3
46.0		2.4	2.6			3.5	3.6	3.5	3.5		3.6	3.5	3.5	3.5		3.8	3.8	3.6	3.3	3.1
48.0						2.8	3.2	3.1	3.1		3.2	3.2	3.1	3.1		3.4	3.4	3.4	3.1	2.9
50.0						2.2	2.5	2.8	2.7		2.8	2.8	2.8	2.8		3.0	3.0	3.0	2.9	2.8
54.0											1.9	2.1	2.2	2.2		2.4	2.4	2.4	2.4	
58.0																1.8	1.8	1.9	1.9	





118t

DIN/ISO/EN

m	55.6 m + 1.6 m + 10.3 m					55.6 m + 1.6 m + 17.2 m					55.6 m + 1.6 m + 24.1 m					55.6 m + 1.6 m + 31.0 m				
	5°	15°	30°	45°	60°	5°	15°	30°	45°	60°	5°	15°	30°	45°	60°	5°	15°	30°	45°	60°
12.0	14.6																			
14.0	14.6	13.7																		
16.0	13.4	12.5				12.0														
18.0	12.3	11.5	10.6	10.0		11.0	10.0				9.4									
20.0	11.2	10.6	9.8	9.3	8.9	10.0	9.2				9.4					6.4				
22.0	10.3	9.8	9.1	8.6	8.4	9.2	8.5	7.8			8.7	8.0				6.4				
24.0	9.6	9.0	8.5	8.1	7.8	8.5	7.9	7.2			8.1	7.4				6.4				
26.0	8.6	8.4	7.9	7.6	7.4	7.9	7.4	6.8	6.4		7.5	6.9				6.4	6.3			
28.0	7.6	7.5	7.3	7.1	6.9	7.3	6.9	6.3	6.0	5.7	6.9	6.4	5.8			6.4	5.9			
30.0	6.6	6.5	6.4	6.3	6.2	6.6	6.4	5.9	5.5	5.3	6.5	6.0	5.5			6.0	5.5			
32.0	5.8	5.7	5.6	5.6	5.5	5.8	5.7	5.4	5.1	4.9	6.0	5.6	5.1			5.6	5.2			
34.0	5.0	5.0	4.9	4.8	4.8	5.0	5.0	4.9	4.6	4.4	5.4	5.1	4.7	4.4		5.1	4.7	4.3		
36.0	4.3	4.3	4.2	4.2		4.4	4.4	4.4	4.2	4.1	4.7	4.6	4.2	4.0	3.8	4.6	4.3	3.9		
38.0	3.6	3.6	3.6	3.6		3.8	3.8	3.8	3.8	3.7	4.2	4.2	3.9	3.6	3.5	4.2	3.9	3.6		
40.0	3.0	3.0	3.0	3.0		3.2	3.3	3.3	3.3	3.3	3.6	3.7	3.5	3.3	3.2	3.8	3.5	3.3	3.1	
42.0	2.5	2.5	2.5	2.5		2.7	2.8	2.8	2.9	2.8	3.1	3.2	3.2	3.0	2.9	3.3	3.2	2.9	2.8	
44.0	2.0	2.0	2.0	2.0		2.2	2.3	2.4	2.4		2.7	2.8	2.8	2.7	2.6	2.8	2.9	2.7	2.5	2.4
46.0											2.2	2.3	2.5	2.4		2.4	2.6	2.4	2.3	2.2
48.0								1.9	2.0	2.0						2.0	2.2	2.1	2.0	1.9
50.0											1.5	1.6	1.7	1.8		1.7	1.9	1.9	1.8	1.7

HTLJ / Tragfähigkeiten
 HTLJ / Lifting capacities
 HTLJ / Capacités de levage
 HTLJ / Capacidades de elevación

118t

DIN/ISO/EN

m	60.0 m + 1.6 m + 10.3 m					60.0 m + 1.6 m + 17.2 m					60.0 m + 1.6 m + 24.1 m					60.0 m + 1.6 m + 31.0 m				
	5°	15°	30°	45°	60°	5°	15°	30°	45°	60°	5°	15°	30°	45°	60°	5°	15°	30°	45°	60°
14.0	12.0																			
16.0	11.7	11.0				8.0														
18.0	10.7	10.0	9.3			8.0					7.1									
20.0	9.7	9.2	8.6	8.2		8.0	8.0				7.1									
22.0	8.9	8.5	7.9	7.6	7.3	8.0	7.8				7.1						5.7			
24.0	8.2	7.8	7.4	7.1	6.9	7.7	7.2	6.6			7.1	6.6				5.7				
26.0	7.1	7.1	6.8	6.6	6.4	7.1	6.7	6.2			6.6	6.1				5.7				
28.0	6.2	6.1	6.1	6.0	5.8	6.5	6.2	5.8	5.5		6.1	5.7				5.7	5.3			
30.0	5.3	5.3	5.2	5.2	5.1	5.7	5.7	5.3	5.0	4.8	5.7	5.3	4.9			5.3	5.0			
32.0	4.5	4.5	4.5	4.5	4.4	4.9	5.0	4.8	4.5	4.3	5.1	4.8	4.4			4.8	4.5			
34.0	3.8	3.8	3.8	3.8	3.7	4.2	4.3	4.3	4.1	3.9	4.4	4.3	4.0	3.8		4.3	4.1			
36.0	3.1	3.2	3.2	3.2		3.6	3.7	3.8	3.7	3.5	3.8	3.8	3.6	3.4		3.9	3.7	3.4		
38.0	2.5	2.6	2.6	2.6		3.0	3.1	3.2	3.3	3.2	3.3	3.4	3.2	3.1	2.9	3.5	3.3	3.1		
40.0		2.0	2.1	2.1		2.5	2.6	2.7	2.8	2.7	2.8	2.9	2.9	2.7	2.6	3.0	2.9	2.7		
42.0						2.0	2.1	2.2	2.3	2.3	2.3	2.5	2.6	2.4	2.3	2.5	2.6	2.4	2.3	
44.0						1.6	1.7	1.8	1.9		1.9	2.0	2.2	2.2	2.1	2.1	2.3	2.2	2.1	
46.0											1.5	1.6	1.8	1.9	1.8	1.7	1.9	1.9	1.8	
48.0													1.6			1.6	1.6	1.6		

58t

DIN/ISO/EN

m	40.4 m + 1.6 m + 10.3 m					40.4 m + 1.6 m + 17.2 m					40.4 m + 1.6 m + 24.1 m					40.4 m + 1.6 m + 31.0 m					
	5°	15°	30°	45°	60°	5°	15°	30°	45°	60°	5°	15°	30°	45°	60°	5°	15°	30°	45°	60°	
9.0	39.9																				
10.0	37.4					16.7															
11.0	35.2	33.2				16.7															
12.0	33.3	31.5				16.7															
14.0	29.9	28.4	26.8			16.7	16.7				16.1										
16.0	27.0	25.9	24.5	23.6	22.7	16.7	16.7				15.6					10.9					
18.0	22.6	23.7	22.6	21.8	21.3	16.7	16.7	16.7			15.2	13.8				10.8					
20.0	17.7	19.0	20.6	20.2	19.8	16.7	16.7	16.7			14.7	13.3				10.6					
22.0	13.4	14.7	16.4	17.4	17.9	16.6	16.7	16.7	14.4		14.2	12.8				10.3	9.4				
24.0	9.9	11.1	12.6	13.6	14.1	13.2	15.0	16.2	14.0	12.9	13.7	12.4				10.1	9.0				
26.0	7.1	8.1	9.4	10.2	10.6	10.2	12.0	14.1	13.7	12.7	12.5	12.0	10.8			9.8	8.6				
28.0		5.6	6.7	7.4	7.6	7.8	9.3	11.4	12.8	12.5	10.0	11.7	10.4			9.4	8.3				
30.0				5.0		5.7	7.1	8.9	10.3	11.1	7.9	9.8	10.1	9.3		9.0	7.9	6.9			
32.0						3.9	5.1	6.8	8.0	8.5	6.1	7.8	9.8	9.1	8.4	8.1	7.6	6.6			
34.0								4.9	5.9	6.3	4.5	6.0	8.2	8.9	8.2	6.5	7.4	6.4			
36.0									4.1				4.5	6.4	8.0	8.1	5.1	6.9	6.2	5.7	
38.0														4.9	6.3	7.0	3.8	5.5	6.0	5.5	
40.0																		4.2	5.9	5.4	5.1
42.0																		3.1	5.0	5.3	5.1
44.0																			3.8	5.2	5.0
46.0																				4.0	4.8
48.0																				2.9	

MB + HTLJ

HTLJ / Tragfähigkeiten
 HTLJ / Lifting capacities
 HTLJ / Capacités de levage
 HTLJ / Capacidades de elevación





58t

DIN/ISO/EN

m	45.4 m + 1.6 m + 10.3 m					45.4 m + 1.6 m + 17.2 m					45.4 m + 1.6 m + 24.1 m					45.4 m + 1.6 m + 31.0 m					
	5°	15°	30°	45°	60°	5°	15°	30°	45°	60°	5°	15°	30°	45°	60°	5°	15°	30°	45°	60°	
10.0	29.6																				
11.0	28.4					16.7															
12.0	26.9	25.0				16.7															
14.0	24.2	22.7				16.7															
16.0	22.0	20.8	19.4	18.4		16.7	16.7				14.8					10.4					
18.0	20.2	19.1	17.9	17.1	16.6	16.7	16.7				14.4					10.2					
20.0	17.7	17.7	16.6	16.0	15.5	16.7	15.8	14.6			14.1	13.0				10.0					
22.0	13.4	14.8	15.5	14.9	14.6	15.7	14.7	13.7			13.7	12.6				9.8					
24.0	10.0	11.2	12.7	13.8	13.7	13.0	13.7	12.8	12.2	11.8	13.4	12.2				9.6	8.8				
26.0	7.1	8.2	9.5	10.5	10.9	10.1	11.9	12.0	11.5	11.1	12.2	11.7				9.4	8.5				
28.0			6.9	7.6	7.9	7.6	9.2	11.3	10.8	10.5	9.7	11.0	10.2			9.3	8.1				
30.0						5.6	7.0	8.9	10.2	10.0	7.6	9.6	9.7			8.9	7.8				
32.0							5.1	6.8	8.1	8.8	5.8	7.6	9.1	8.7		7.8	7.6	6.5			
34.0								4.9	6.0	6.6		5.8	8.1	8.3	8.1	6.2	7.3	6.3			
36.0										4.6					6.4	7.9	7.7	4.8	6.6	5.6	
38.0														4.8	6.3	7.2		5.2	6.0	5.5	
40.0															4.7	5.5		4.0	5.8	5.4	5.1
42.0																			4.9	5.2	5.1
44.0																			3.7	5.1	5.0
46.0																				4.0	4.9





58t

DIN/ISO/EN

m	50.5 m + 1.6 m + 10.3 m					50.5 m + 1.6 m + 17.2 m					50.5 m + 1.6 m + 24.1 m					50.5 m + 1.6 m + 31.0 m					
	5°	15°	30°	45°	60°	5°	15°	30°	45°	60°	5°	15°	30°	45°	60°	5°	15°	30°	45°	60°	
11.0	20.8																				
12.0	19.8																				
14.0	18.0	16.3				15.8															
16.0	16.5	15.1	13.5			14.4	12.8				12.8										
18.0	15.0	14.0	12.7	11.8	11.2	13.3	11.9				11.8					9.1					
20.0	13.7	13.0	11.9	11.1	10.6	12.3	11.1				10.9	9.7				9.1					
22.0	12.6	12.1	11.2	10.5	10.1	11.4	10.4	9.2			10.1	9.0				9.1					
24.0	10.3	11.1	10.5	10.0	9.6	10.7	9.7	8.7	8.0		9.5	8.5				8.8					
26.0	7.4	8.5	9.9	9.5	9.2	10.0	9.1	8.2	7.6	7.2	8.8	8.0	7.0		8.2	7.4					
28.0			7.2	8.1	8.4	7.8	8.6	7.8	7.3	6.9	8.3	7.5	6.7		7.7	6.9					
30.0						7.2	7.4	6.9	6.6	6.6	7.6	7.1	6.3		7.3	6.5					
32.0							7.0	6.6	6.4	6.4		6.7	6.0	5.5	6.8	6.2	5.5				
34.0									6.3	6.1			5.9	5.7	5.3	5.0	6.1	5.9	5.2		
36.0														5.4	5.1	4.8	4.7	5.5	5.0		
38.0															4.8	4.5		5.2	4.7	4.3	
40.0																4.3			4.4	4.0	
42.0																			4.2	3.8	3.5
44.0																				3.5	3.3
46.0																				3.3	3.1

HTLJ / Tragfähigkeiten
 HTLJ / Lifting capacities
 HTLJ / Capacités de levage
 HTLJ / Capacidades de elevación

58t

DIN/ISO/EN

m	55.6 m + 1.6 m + 10.3 m					55.6 m + 1.6 m + 17.2 m					55.6 m + 1.6 m + 24.1 m					55.6 m + 1.6 m + 31.0 m				
	5°	15°	30°	45°	60°	5°	15°	30°	45°	60°	5°	15°	30°	45°	60°	5°	15°	30°	45°	60°
12.0	14.6																			
14.0	14.6	13.7																		
16.0	13.4	12.5				12.0														
18.0	12.3	11.5	10.6	10.0		11.0	10.0				9.4									
20.0	11.2	10.6	9.8	9.3	8.9	10.0	9.2				9.4					6.4				
22.0	10.3	9.8	9.1	8.6	8.4	9.2	8.5	7.8			8.7	8.0				6.4				
24.0	9.6	9.0	8.5	8.1	7.8	8.5	7.9	7.2			8.1	7.4				6.4				
26.0	8.0	8.4	7.9	7.6	7.4	7.9	7.4	6.8	6.4		7.5	6.9				6.4	6.3			
28.0			7.3	7.1	6.9	7.3	6.9	6.3	6.0	5.7	6.9	6.4	5.8			6.4	5.9			
30.0					6.2		6.4	5.9	5.5	5.3	6.5	6.0	5.5			6.0	5.5			
32.0								5.4	5.1	4.9	6.0	5.6	5.1			5.6	5.2			
34.0									4.6	4.4		5.1	4.7	4.4		5.1	4.7	4.3		
36.0													4.2	4.0	3.8		4.3	3.9		
38.0													3.9	3.6	3.5			3.6		
40.0														3.3	3.2			3.3	3.1	
42.0																		2.9	2.8	
44.0																			2.5	

58t

DIN/ISO/EN

m	60.0 m + 1.6 m + 10.3 m					60.0 m + 1.6 m + 17.2 m					60.0 m + 1.6 m + 24.1 m					60.0 m + 1.6 m + 31.0 m				
	5°	15°	30°	45°	60°	5°	15°	30°	45°	60°	5°	15°	30°	45°	60°	5°	15°	30°	45°	60°
14.0	12.0					8.0														
16.0	11.7	11.0				8.0														
18.0	10.7	10.0	9.3			8.0					7.1									
20.0	9.7	9.2	8.6	8.2		8.0	8.0				7.1									
22.0	8.9	8.5	7.9	7.6	7.3	8.0	7.8				7.1					5.7				
24.0	8.2	7.8	7.4	7.1	6.9	7.7	7.2	6.6			7.1	6.6				5.7				
26.0		7.1	6.8	6.6	6.4	7.1	6.7	6.2			6.6	6.1				5.7				
28.0				6.0	5.8	6.5	6.2	5.8	5.5		6.1	5.7				5.7	5.3			
30.0							5.7	5.3	5.0	4.8	5.7	5.3	4.9			5.3	5.0			
32.0								4.8	4.5	4.3		4.8	4.4			4.8	4.5			
34.0									4.1	3.9						4.1				
36.0													4.0	3.8						
38.0													3.6	3.4				3.7	3.4	
40.0														3.1					3.1	
																			2.7	

MB + HTLJ

Anmerkungen zu den Traglasttabellen
Remarks relating to the rating charts
Remarques relatives aux tableaux des charges
Notas relativas a los graficos de carga

Anmerkungen zu den Traglasttabellen

Die Tragfähigkeiten im Festigkeitsbereich basieren auf DIN 15018 Blatt 2 und Blatt 3 und F.E.M.

Die Tragfähigkeiten im Standsicherheitsbereich entsprechen DIN 15019 Teil 2 / ISO 4305 / EN 13000.

In Abhängigkeit der Auslegerlänge sind bei den Traglasttabellen Windgeschwindigkeiten von max. 10 m/s am Teleskopausleger und max. 7 m/s mit der Auslegerverlängerung zulässig.

Die Tragfähigkeiten sind in metrischen Tonnen angegeben.

Das Gewicht des Lasthakens bzw. der Hakenflasche und weiterer Anschlagmittel ist von der Tragfähigkeit abzuziehen.

Die Tragfähigkeiten für den Teleskopausleger gelten nur bei demon- tierter Spitze.

Die Ausladung ist der horizontale Abstand von Mitte Drehkranz bis Mitte freihängender, nicht schwingender Last.

Tragfähigkeitsänderungen vorbehalten.

Obige Angaben dienen nur zur Information. Die Bedienungsanlei- tungen müssen zu Rate gezogen werden, bevor die Maschine in Betrieb genommen wird. Alle hier gemachten Angaben beziehen sich auf die Standard-Ausführung. Jegliche Ausrüstungsverände- rungen können die angegebenen Werte beeinflussen.

Remarks relating to the rating charts

The lifting capacities in the structural area are based on DIN 15018 parts 2 and 3 and F.E.M.

The lifting capacities in the stability area are based on DIN 15019 part 2 / ISO 4305 / EN 13000.

Maximum admissible wind velocity for working with telescopic boom is 10 m/sec to 7 m/sec depending at boom length and for working with fly jib 7 m/sec.

The lifting capacities are shown in metric tons.

The weight of load handling devices such as hook blocks, slings, etc., must be considered as part of the load and must be deducted from the lifting capacities.

The lifting capacities for the telescopic boom apply to a crane with no boom extensions being stowed or mounted on the crane.

The working radius is the horizontal distance from the centre of rotation to the centre of the freely suspended non-oscillating load.

The lifting capacities are subject to change without prior notice.

The above remarks are for basic information only and the operator's manual must be consulted before operating this crane. All data and performances refer to the standard crane. The addition of optional and other equipment may affect the performance of the crane.

Remarques relatives aux tableaux des charges

Les forces de levage sont conformes aux normes DIN 15018, p. 2 et 3, et F.E.M.

Les forces de levage dans la partie de stabilité au renversement sont conformes aux normes DIN 15019, chap. 2 / ISO 4305 / EN 13000.

Des vitesses de vent sont admissibles entre 7 m/s jusqu'à max 10 m/s en fonction de la longueur de flèche.

Les forces de levage sont données en tonnes métriques.

Le poids du crochet-moufle et de tous les accessoires d'élingage font partie de la charge et sont à déduire des charges indiquées.

Les forces de levage indiquées pour la flèche télescopique s'entendent fléchette déposée.

Comme portée, on entend la distance horizontale du centre de la couronne de rotation au centre de la charge librement suspendue et non oscillante.

Sauf modification de forces de levage.

Les données ci-dessus servent à titre d'information. Avant la mise en marche de la grue il est conseillé d'étudier les instructions de service. Toutes les données indiquées ci-dessus se réfèrent à la machine de base. Tout changement de l'équipement de la grue peut influencer ces valeurs.

Notas relativas a los graficos de carga

En cuanto a los datos referentes a resistencia, las capacidades de carga están basados sobre las normas DIN 15018, pág. 2 y 3, y F.E.M.

En cuanto a los datos referentes a estabilidad anti-vuelco, las capacidades de carga están basados sobre las normas DIN 15019, Cap. 2 / ISO 4305 / EN 13000.

En independencia a la longitud de la pluma, están toleradas velocidades de viento de entre 7 m/s y 10 m/s.

Las capacidades de carga indicadas en las tablas corresponden a toneladas métricas.

Hay que deducir los pesos del gancho, eslingas y de otros dispositivos para fijación de cargas de los valores indicados en las tablas.

Las capacidades de carga referentes a la pluma telescópica valen solamente si el plumín está desmontada.

Como alcance se entiende la distancia horizontal desde el centro de la corona de giro hasta el centro de la carga suspendida libremente y no oscilante.

Salvo modificación de capacidades de carga, sin previo aviso.

Los datos arriba indicados sirven solamente para su información. Hay que leer las instrucciones para el uso antes de la puesta en servicio de la máquina. Todos los datos mencionados en las presentes tablas rigen para los modelos standard. Cualquier modificación del equipo montado puede dar lugar a modi-ficaciones de aquellos valores.

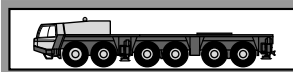

Rahmen Verwindungs- und biegesteife Schweißkonstruktion aus hochfestem Feinkornstahl. Zentralschmieranlage.

Abstützung 4-Punkt-Abstützung, hydraulisch, Bedienungsmöglichkeiten an beiden Seiten des Fahrgestelles und in der Oberwagenkabine.

Abstützbasis 8,5 m (und 8,0 m, 6,8 m, 5,5 m) x 8,9 m.

Motor Mercedes-Benz 8-Zylinder-Dieselmotor OM 502 LA (Euromot III B), wassergekühlt, Leistung 480 kW (653 PS) bei 1800 min⁻¹.

Drehmoment 3000 Nm (306 kpm) bei 1300 min⁻¹. Motorleistung nach 80/1269/EWG. Kraftstoffbehälter 450 l. AdBlue-Behälter 40 l.

Getriebe ZF-TC-Tronic "Heavy Duty", mechanisches Schaltgetriebe mit Wandlerschaltkupplung und integriertem Intarder, elektronisch-pneumatisch betätigter Trockenkupplung und vollautomatischer Schaltung mit 12 Vorwärts- und 2 Rückwärtsgängen. Power and Economy Modus wählbar.

Verteilergetriebe

Antrieb 12 x 8 x 12

Achsen

1. Achse: gelenkt, angetrieben, Differentialsperre quer.
2. Achse: gelenkt, nicht angetrieben.
3. Achse: gelenkt, angetrieben, Differentialsperre längs und quer.
4. Achse: gelenkt, angetrieben, Differentialsperre quer.
5. Achse: gelenkt, angetrieben, Differentialsperre quer.
6. Achse: gelenkt, nicht angetrieben.

Achsaufhängung Hydropneumatische Federung mit Niveauregulierung.

Bremsen Druckluft-Zweikreis-Scheibenbremsanlage. Feststellbremse als Federspeicherbremse an der 3., 4., 5. und 6. Achse wirkend. Intarder mit Bremsomat-Funktion und Konstantdrosselanlage mit Auspuffklappenbremse als Dauerbremse.

Räder 12-fach 445/95 R 25 (16.00 R 25).

Lenkung ZF-Servocom-Zweikreis-Hydraulenlenkung mit Notlenkpumpe. Mechanische Lenkung der 1. und 2. Achse.

Im Betriebsmodus "Straße" werden die Achsen 3-6 bis zu einer Geschwindigkeit von 30 km/h elektronisch mitgelenkt. Ab einer Geschwindigkeit von 30 km/h werden die Achsen 4 und 5 in Geradeausposition verriegelt und ab einer Geschwindigkeit von 50 km/h zusätzlich die Achsen 3 und 6.

Unterwagenkabine Zwei-Mann-Frontfahrerhaus in Stahl- Kunststoff-Verbund-Konstruktion, Sicherheitsverglasung, luftgefederte Sitze (Fahrersitz mit Heizung) und motorabhängige Warmwasserheizung, Radio-CD-Player, Kontroll- und Bedienungselemente für den Fahrbetrieb, Tempomat- / Bremsomat-Funktion.

Elektrische Anlage 24 Volt-Gleichstrom, 2 Batterien, Verdrahtung mit CAN-Bus-Komponenten, integrierte Eigendiagnose Faun-CSS-System, Abstützbeleuchtung. Die elektrische Anlage entspricht der EG-Norm.

Zusatzrüstung (gegen Mehrpreis)
Anhängerkupplung, motorabhängige Zusatzheizung mit Motorvorwärmung, Klimaanlage, ABS, 525/80 R 25 (20.5 R 25) Bereifung, Reserverad, Sonderlackierung und Beschriftung.
Weitere Zusatzrüstung auf Anfrage.

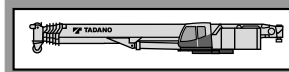

Rahmen Verwindungssteife Schweißkonstruktion mit einer außenverzahnten, dreireihigen Rollendrehverbindung, um 360° unbegrenzt drehbar. Zentralschmieranlage.

Motor Mercedes-Benz 6-Zylinder-Dieselmotor OM 926 LA (Euromot III B), wassergekühlt. Drehzahl ist über Fußpedal stufenlos regelbar, Leistung 195 kW (265 PS) bei 2200 min⁻¹. Drehmoment 1100 Nm (112 kpm) bei 1200 - 1600 min⁻¹, Motorleistung nach DIN 6270B / DIN 6271. Kraftstoffbehälter 230 l. AdBlue-Behälter: 8 l.

Hydraulik System Diesel-hydraulisch mit 3-Kreis-Hydraulik, 1 leistungsgeregelte Axialkolben-Doppelpumpe (hydraulisch verstellbar), 1 Axialkolbenpumpe und 1 Zahnradpumpe, Ölkühler.

Steuerung Zwei 4-fach Kreuzsteuerhebel mit elektrischer Vorsteuerung.

Teleskopausleger Fünfteiliger Teleskopausleger aus hochfestem Feinkornstahl, bestehend aus einem Grundausleger und 4 Teleskopteilen, 1 Teleskopzylinder, hydraulisch unter Teillast teleskopierbar. 15,0 m - 60,0 m lang.

Wippwerk Ein Differentialzylinder mit angebautem Senkbremssperventil.

Hubwerk Axialkolben-Verstell-Motor, Hubwerkstrommel mit eingebautem Planetengetriebe und federbelasteter Hydro-Lamellenbremse mit integriertem Freilauf beim Heben. Hubseil mit 'Super-Stop' Einrichtung.

Drehwerk Axialkolben-Motor, dreistufiges Planetengetriebe mit automatischer Betriebs- und Feststellbremse. Offener Hydraulikkreislauf mit Drehwerk-Freisaltung. Drehgeschwindigkeit stufenlos von 0 - 1,1 min⁻¹.

Gegengewicht Gesamtgewicht 138 t teilbar. Die Bedienung erfolgt mittels einer Fernbedieneinheit.

Oberwagenkabine Großräumige Krankabine in Stahl-Kunststoffausführung mit Sicherheitsverglasung und getönten Scheiben, kippbarem Arbeitsplatz mit verstellbarem, hydraulisch gedämpftem Fahrersitz mit Heizung, motorabhängige und motorunabhängige Warmwasserheizung (mit Motorvorwärmung), Radio-CD-Player, Kontroll- und Bedienungselemente sowie graphische LCD-Anzeige für Kranbetrieb.

Elektrische Anlage 24 Volt-Gleichstrom, 2 Batterien.

Sicherheitseinrichtungen 'Lift- und 'Release Adjuster', (automatische Überwachung des Arbeitsradius in Folge Auslegerverformung durch Lasteinwirkung), Lastmomentbegrenzung (LMB), Windmesser, Arbeitsbereichsbegrenzung, Hubendschalter, Windenendschalter, Seilwindendrehmelder, Sicherheitsventile gegen Rohr- und Schlauchbrüche. Sperrventile an Hydraulik-Zylindern.

Zusatzrüstung (gegen Mehrpreis)
Power-System PS, verschiedene Auslegerverlängerungen, Unterflaschen von 12,5 t bis 250 t, Klimaanlage, 2. Hubwerk, Sonderlackierung und Beschriftung.

Weitere Zusatzrüstung auf Anfrage.

Equipment

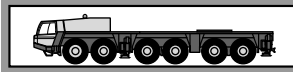

Frame Torsion resistant, welded construction made from high strength, fine-grained steel. Central lubricating system.

Outriggers 4 point, double telescopic hydraulic outriggers with controls on both sides of carrier and in superstructure cab. Outrigger base 8.5 m (8.0 m, 6.8 m, 5.5 m mid extension) x 8.9 m.

Carrier engine Mercedes-Benz 8 cylinder model OM 502 LA (Euromot III B), water-cooled diesel engine. Rated at 480 kW (653 HP) at 1800 min⁻¹. Torque 3000 Nm (306 kpm) at 1300 min⁻¹. Engine rating according to 80 / 1269 / EWG. Fuel tank 450 l. AdBlue-tank 40 l.

Transmission ZF-TC-Tronic HD transmission in "heavy duty" version with torque converter and integrated intarder, electro-pneumatically operated dry-type clutch and automatic gear shifting with 12 forward gears and 2 reverse gears. Power / Economy mode.

Transfer Case

Drive 12 x 8 x 12

Axles

1st axle: steered, driven.
2nd axle: steered, not driven.
3rd axle: steered, driven, with longitudinal differential lock.
4th axle: steered, driven.
5th axle: steered, driven.
6th axle: steered, not driven.
All driven axles with transverse differential locks.

Suspension Hydro-pneumatic with levelling adjustment.

Brake system Service disc brakes: dual circuit compressed air system. Parking brake: spring loaded type acting on 3rd, 4th, 5th and 6th axles. Auxiliary brakes: intarder with 'Bremsomat' function, engine exhaust brake and constant throttle engine brake system.

Tyres (12) 445/95 R 25 (16.00 R 25).

Steering system ZF-Servocom, dual circuit hydraulic steering with emergency steering pump, mechanical hydraulically-assisted steering of front two axles. On road mode the 1st and 2nd axle are permanently steered and mechanically connected to the steering gear unit and the 3rd, 4th, 5th and 6th axle are automatically steered, electro-hydraulically, with the 1st and 2nd axles up to a travel speed of 30 km/h and 50 km/h respectively. At a speed of 30 km/h, the 4th and 5th axles are automatically locked in the straight ahead position. At a speed of 50 km/h, the 3rd and 6th axle is automatically locked in the straight ahead position.

Carrier cab Two man full width cab of composite (steel sheet metal and fibre-glass) structure, with safety glass, air-cushioned adjustable seats (driver seat with heater) and engine dependent hot-water heater, air conditioning, radio- CD-player, complete controls and instrumentation for road travel. 'Tempomat-/ Bremsomat' function.

Electrical system 24 volt DC system, 2 batteries, CAN-Bus system with Faun CSS integrated self-diagnosis system, outrigger lighting. Electrical system conforms with EEC regulations.

Optional Equipment (at extra charge)

Towing attachment, engine independent additional heater with engine pre-heat, ABS, 525/80 R 25 (20.5 R 25) tyres, spare wheel and tyre, special painting and lettering.

Further optional equipment available upon request.

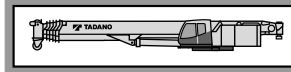

Frame Torsion-resistant, all-welded structure of high strength steel. Connected to carrier by triple roller bearing slewing ring with external gearing for 360° continuous rotation. Central lubricating system.

Superstructure engine Mercedes-Benz 6 cylinder model OM 926 LA (Euromot III B), water cooled, diesel engine. PRM infinitely variable via foot pedal, rating 195 kW (265 HP) at 2200 min⁻¹. Torque 1100 Nm (112 kpm) at 1200 - 1600 min⁻¹. Engine rating according to DIN 6270B / DIN 6271. Fuel tank 230 l. AdBlue-tank 8 l.

Hydraulic system Three circuit diesel hydraulic system with 1 power controlled axial piston double pump (hydraulically adjustable) 1 axial piston pump and 1 gear pump, oil cooler.

Controls Electrical, 2 joy-stick levers for simultaneous operation of crane motions.

Telescopic boom 5 sections, made of high tensile, fine-grained steel, consisting of 1 base section and 4 telescoping sections extended by means of a single telescopic cylinder. All telescope sections extendable under partial load. 15.0 m to 60.0 m long.

Derricking system 1 double acting hydraulic cylinder with integral brake and holding valve.

Main winch Axial piston variable displacement motor, winch drum with integrated planetary reduction and with hydraulically controlled spring-loaded, multiple disc brake. Hoist cable with 'Super-Stop' easy reeving system.

Slewing system Axial piston motor with three-stage planetary gear with automatic service and a parking brake. Open hydraulic circuit with free slewing function. Speed infinitely variable 0 - 1.1 min⁻¹.

Counterweight Total 138 t divisible, assembled and disassembled by hydraulic cylinders operated by remote control.

Superstructure cab Spacious panoramic cab of composite structure with safety (tinted) glass windows, tiltable cockpit with hydraulically cushioned adjustable seat with heater, one engine dependent hot-water heater and one engine independent hot-water heater (with engine pre-heat), air conditioning, radio-CD-player. Complete controls and instrumentation plus LCD graphic display for crane operation.

Electrical system 24 volt DC system, 2 batteries.

Safety devices 'Lift- and Release Adjuster', (automatic radius correction based on boom deflection under load) load moment device (LMD), anemometer, working area limitation, hoist limit switch, lower limit switch and drum turn indicator, safety valves against pipe and hose rupture, holding valves on hydraulic cylinders.

Optional Equipment (at extra charge)

Power-System PS, several boom extensions, hook blocks 12.5 t - 250 t, auxiliary winch, special painting and lettering.

Further optional equipment available upon request.

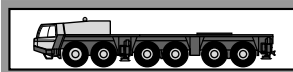

Châssis Construction mécanosoudée, en acier à grain fin très rigide, résistant aux flexions et aux torsions. Graissage centralisé.

Calage Dispositif de calage horizontal et vertical en 4 points, entièrement déployable hydrauliquement. Commande des mouvements sur les deux côtés du porteur et depuis la cabine de la superstructure. Calage 8,5 m (8,0 m, 6,8 m, 5,5 m à mi-extension) x 8,9 m.

Moteur Mercedes Benz diesel 8 cylindres, modèle OM 502 LA (Euromot III B), refroidi par eau, de 480 kW (653 CV) à 1800 min⁻¹. Couple: 3000 Nm (275 kpm) à 1300 min⁻¹. Puissance selon 80/1269/EWG. Capacité du réservoir 450 l. AdBlue-capacité du réservoir 40 l.

Boîte de vitesse Boîte de vitesse ZF-TC-Tronic "Heavy Duty". Boîte mécanique avec convertisseur et Intarder intégré, avec embrayage électro-pneumatique à commande automatique, 12 vitesses AV et 2 vitesses AR. Mode max. performance/économique.

Boîte de transfert

Entraînement 12 x 8 x 12

Essieux

- 1^{er} essieu: directeur, entraîné, blocage de différentiel transversal.
- 2^{ème} essieu: directeur, non entraîné.
- 3^{ème} essieu: directeur, entraîné, blocage de différentiel longitudinal et transversal.
- 4^{ème} essieu: directeur, entraîné, blocage de différentiel transversal.
- 5^{ème} essieu: directeur, entraîné, blocage de différentiel transversal.
- 6^{ème} essieu: directeur, non entraîné.

Suspension Hydro-pneumatique, avec réglage de niveau.

Freins Freins de service à disque: système à double circuit d'air comprimé. Frein de stationnement: avec accumulateurs à ressort agissant sur le 3^{ème}, 4^{ème}, 5^{ème} et 6^{ème} essieu. Freins continus: frein moteur par clapet sur échappement. Ralentisseur hydrodynamique Intarder.

Pneus 12 x 445/95 R 25 (16.00 R 25).

Direction Servocom à double circuit, marque ZF avec pompe de direction auxiliaire. Direction mécanique du 1^{er} et 2^{ème} essieu. En mode "route" les essieux 3 - 6 sont directionnels jusqu'à une vitesse de 30 km/h. A partir d'une vitesse de 30 km/h les essieux 4 et 5 sont verrouillés dans une droite et position à partir de 50 km/h les essieux 3 et 6 sont aussi verrouillés.

Cabine Cabine bi-place, construction en matière composite fibre de verre et acier. Vitrage en verre de sécurité, siège conducteur chauffant suspendu hydrauliquement. Chauffage à eau chaude relié au moteur, radio-CD-player. Organes de contrôle et de commande pour la conduite. Régulateur de vitesse, système automatique de freinage.

Système électrique 24 V courant continu, 2 batteries, connexion circuit électrique avec CAN-Bus. Équipement avec prise diagnostic et avec interprétation de code erreur de système FAUN CSS, éclairage des points de calage. Conforme aux normes CE.

Équipement supplémentaire (avec supplément de prix)
Attache-remorque, chauffage auxiliaire indépendant du moteur avec préchauffage du moteur, climatisation, ABS, pneus 525/80 R 25 (20.5 R 25), roue de secours, peinture spéciale et inscription.
Autres équipements supplémentaires sur demande.

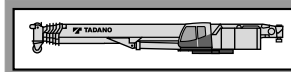

Plate forme Construction mécano-soudée résistante à la torsion. Couronne d'orientation à triple rangée de rouleaux avec denture extérieure pour une rotation à 360° en continu. Graissage centralisé.

Moteur Mercedes Benz diesel 6 cylindres, modèle OM 926 LA (Euromot III B), refroidi par eau. Réglage du nombre de tours par pédale, de 195 kW (265 CV) à 2200 min⁻¹. Couple: 1100 Nm (112 kpm) à 1200 - 1600 min⁻¹. Puissance selon DIN 6270B/DIN 6271. Capacité du réservoir 230 l. AdBlue-capacité du réservoir 8 l.

Système hydraulique Diesel-hydraulique à 3 circuits, 1 double pompe à pistons axiaux à régulation de puissance (à réglage hydraulique) 1 pompe à pistons axiaux et 1 pompe à engrenages, refroidisseur d'huile.

Commande 2 manipulateurs à commande en croix (4 sens), assistés électriquement.

Flèche télescopique 1 flèche de base et 4 éléments télescopiques en acier fin, 1 vérin télescopique, hydrauliquement télescopable avec charge partielle. Longueur de 15,0 m à 60,0 m.

Mécanisme de relevage 1 vérin différentiel muni de clapet de freinage de descente.

Mécanisme de levage Moteur hydraulique à cylindrée variable, tambour de levage avec boîte planétaire incorporée, frein d'arrêt à disques multiples à ressort, libéré lors du levage. Câble de levage avec dispositif 'Super-Stop'.

Orientation Moteur hydraulique avec entraînement planétaire à 3 gammes avec frein de stationnement automatique. Circuit ouvert avec déconnexion de l'orientation. Vitesse de rotation 0 à 1,1 min⁻¹ en continu.

Contrepoids Poids total 138 t divisible, assembles et démantelés grâce à des vérins hydrauliques télécommandés.

Cabine du grutier Cabine de grue spacieuse, construction en matière combinée acier/synthétique, avec vitrage de sécurité en verre teinté, siège chauffant, réglable et amorti hydrauliquement, inclinable avec instruments de commande, chauffage à eau chaude dépendant et indépendant du moteur (avec préchauffage du moteur), radio-CD-player, éléments de commande et de contrôle avec affichage digital pour travaux.

Système électrique 24 V courant continu, 2 batteries.

Dispositifs de sécurité 'Lift- et 'Release Adjuster', limiteur de charge (CEC), anémomètre, limitation de zone de travail, interrupteur de fin de course de levage et de treuil, indicateur du nombre de tours, soupapes de sécurité contre ruptures des conduites et flexibles, clapets sur verins hydraulique.

Équipement supplémentaire (avec supplément de prix)
Power-System PS, sélection de fléchette, mouffles de 12,5 t à 250 t, climatisation, 2^{ème} treuil de levage, peinture spéciale et inscription.
Autres équipements supplémentaires sur demande.

Equipo

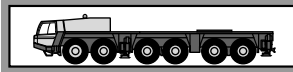

Chasis portante Construcción en acero de alta resistencia soldado, resistente a la torsión y flexión. Engrase centralizado.

Estabilizadores Estabilizadores hidráulicos de 4 puntos. Posibilidad de manejo desde ambos lados del chasis y desde la cabina de la grúa. Base de apoyo 8,5 m (variante 8,0 m, 6,8 m, 5,5 m) x 8,9 m.

Motor Mercedes Benz 8 cilindros; OM 502 LA (Euromot III B), refrigerado por agua. Potencia de 480 kW (653 CV) a 1800 min⁻¹; par 3000 Nm (275 kpm) a 1300 min⁻¹. Potencia de motor según 80/1269/EWG. Depósito de combustible de 450 l. Depósito AdBlue 40 l.

Transmisión Transmisión mecánica modelo ZF-TC Tronic "Heavy Duty". Con convertidor y embrague de puente con Intarder integrado, accionamiento electro-neumático. Embrague seco cambio automático con 12 marchas delanteras + 2 traseras. Modo rendimiento máximo / económico.

Caja Transfer

Tracción 12 x 8 x 12

Ejes

- 1º eje: direccional, accionado, con bloqueo diferencial transversal.
- 2º eje: direccional.
- 3º eje: direccional, accionado, con bloqueo diferencial transversal + longitudinal.
- 4º eje: direccional, accionado, con bloqueo diferencial transversal.
- 5º eje: direccional, accionado, con bloqueo diferencial transversal.
- 6º eje: direccional.

Suspensión Suspensión hidroneumática con regulación de nivel.

Sistemas de frenos Accionamiento neumático con frenos de disco. Frenos de estacionamiento tipo muelles cargados, en los ejes 3º, 4º, 5º y 6º. Intarder con sistema automático de frenado continuo. Sistema de estrangulador sobre el escape.

Neumáticos 12 x 445/95 R 25 (16.00 R 25).

Dirección Dirección hidráulica ZF Servocom de doble circuito y bomba auxiliar de dirección. Dirección mecánica en los ejes 1º y 2º. Ejes 3º - 6º en servicio modo circulación "carretera" acompañan la dirección hasta una velocidad de 30 km/h. A partir de 30 km/h los ejes 4º - 5º se bloquean y quedan sin dirección. A partir de 50 km/h quedan sin dirección los ejes 3º - 6º.

Cabina Cabina para dos personas, en construcción de acero de fibra de vidrio. Cristales de seguridad, asiento con suspensión neumática y calefactado. Calefacción por agua caliente del motor, climatización, radio-CD-player. Elementos de control e instrumentación para la circulación por carretera. Regulador de velocidad, sistema automático de frenado.

Sistema eléctrico Sistema de 24 V c.c. con dos baterías, conexiones eléctricas integradas en el sistema CAN-Bus, sistema integrado de diagnóstico Faun-CSS. Faros de trabajo en los estabilizadores. El sistema eléctrico cumple la normativa CEE.

Equipo adicional (con suplemento de precio)
Embrague de remolque, calefacción adicional con precalefacción del motor, ABS, neumáticos 525/80 R 25 (20.5 R 25), rueda de repuesto, pintura especial y rotulación.
Otros equipamientos sobre pedido.

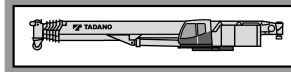

Superestructura Construida en aceros soldados, resistente a la torsión. Corona de giro de dientes externos con un giro de 360°.

Motor Mercedes Benz 6 cilindros modelo OM 926 LA (Euromot III B), refrigerado por agua. Las revoluciones aumentan de forma gradual accionado por el acelerador. Potencia 195 kW (265 Cv) a 2200 min⁻¹. Par 1100 Nm (112 kpm) a 1200 -1600 min⁻¹. Potencia de motor según normativa DIN 6270B/DIN 6271. Depósito de combustible 230 l; depósito de AdBlue 8 l.

Sistema hidráulico Sistema hidráulico de 3 circuitos, 1 bomba doble de pistones axiales (regulada hidráulicamente) 1 bomba axial y 1 bomba dentada. Enfriador de aceite.

Mandos 2 palancas de control de tipo joy-stick para movimientos simultáneos de la grúa (4 direcciones), asistidos eléctricamente.

Pluma telescópica Pluma telescópica compuesta de 5 tramos de acero de alta resistencia, 1 trama base + 4 tramos telescópicos, extensibles bajo carga. Longitud 15,0 m - 60,0 m.

Elevación de pluma Cilindro telescópico con válvula de anti-caída.

Cabestrante principal Motor de pistones axiales variable. Cabestrante con reducción de planetarios y frenos de disco con sistema libre de elevación. Cable de elevación con sistema fácil de guiado 'Super-Stop'.

Sistema de giro Motor hidráulico de pistones axiales con reducción planetaria de tres etapas. Circuito hidráulico abierto con posibilidad con reductor posición veleta. Velocidad de giro gravable desde 0 - 1,1 min⁻¹.

Contrapeso Peso total 138 t divisible. Accionamiento mediante mando a distancia.

Cabina de la grúa Cabina espaciosa y confortable en construcción de acero de fibra de vidrio. Con cristales tintados de seguridad. Asiento de conductor amortiguado hidráulicamente, calefactado. Calefacción independiente, climatización, radio-CD-player. Controles e instrumentación a si como display digital LCD para la operación de la grúa.











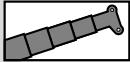

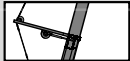
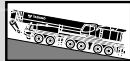
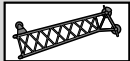







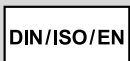

Sistema eléctrico Sistema de 24 V c.c. con dos baterías.

Medidas de seguridad Sistema de 'Lift- and Release Adjuster' limitación de momentos de carga (LMC). Anemómetro limitación de área de trabajo. Final de carrera, control de cabestrante, indicador de vueltas de cabestrante, válvulas de seguridad contra rotura de tuberías y latiguillos. Válvulas de cierre en cilindros hidráulicos.

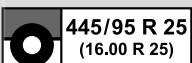
Equipo adicional (con suplemento de precio)
Sistema de potencia PS; Diferentes prolongaciones de plumin; Pastecas desde 12,5 t - 250 t, 2º cabestrante, pintura especial y rotulación.

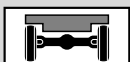
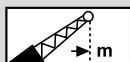
Otros equipamientos sobre pedido.

Symbolerklärung Symbols Glossaire des symboles Glosario de símbolos

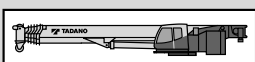
	Teleskopausleger Telescopic boom Flèche télescopique Pluma telescópica		Getriebe / Gang Transmission / Gear Boîte de vitesse / Rapport Transmisión / Marchas
	Power-System		Steigfähigkeit Gradeability Abtitude en pente Superacion de pendientes
	Auslegerverlängerung Boom extension Fléchette Plumín		Gelände Off road Tout-terrain Todo terreno
	Auslegerverlängerung hydraulisch Boom extension hydraulically Fléchette hydrauliquement Plumín hidráulicamente		Straße On road En route En carretera
	Auslegerverlängerung HTLJ Boom extension HTLJ Fléchette HTLJ Plumín HTLJ		Geschwindigkeiten Oberwagen Superstructure speeds Vitesses du partie tournante Velocidades de la superestructura
	Abstützung Outriggers Calage Estabilizadores		Hubwerk Main winch Mécanisme de levage Cabrestante principal
	Drehwerk Slewing system Orientation Sistema de giro		2. Hubwerk Auxiliary winch 2 ^{ème} treuil de levage 2 ^º cabrestante
	Gegengewicht Counterweight Contrepoids Contrapeso		Wippwerk Derricking system Mécanisme de relevage Elevación de pluma
	Siehe Seite 120 As on Page 120 Voyez la page 120 Véase la pagina 120		Teleskopieren Boom telescoping Télescopage de flèche Telescopaje de pluma
	Räder / Größe Tyres / Size Pneus / Largeur Neumáticos / Tamaño de ruedas		Ausladung Radius Portée Radio
	Achslast Axle load Charge à l'essieu Carga por eje		Ausladung Radius Portée Radio
	Unterflasche / Hakengeschild Hook block / Swivel hook Moufle / Elingues Gancho / Gancho de bola		Unterwagen Carrier châssis chasis
	Geschwindigkeiten Unterwagen Carrier speeds Vitesses du châssis Velocidades del chasis		Oberwagen Superstructure partie tournante superestructura

Worldwide offices

TADANO Ltd.

International Division
4-12, Kamezawa 2-chome
Sumida-Ku, Tokyo 130-0014, Japan
Phone: +81-3-3621-7750
Fax: +81-3-3621-7785
E-mail: tdnihq@tadano.co.jp

TADANO Ltd. Middle East

Representative Office
P.O.Box 18302, LOB15-323
Jebel Ali Free Zone, Dubai, UAE
Phone: +971-4-887-1353
Fax: +971-4-887-1703
E-mail: tadano@tadano.ae

TADANO South China Co. Ltd.

Room 1803, 18/F Seaview Commercial
Building 21-24 Connaught Road West
Hong Kong
Phone: +852-2544-9310
Fax: +852-2541-5828
E-mail: info@tadanosc.com

TADANO FAUN GmbH

Faunberg 2
91207 Lauf a. d. Pegnitz
Germany
Phone: +49-9123-955-0
Fax: +49-9123-3085
E-mail: info@tadanofaun.de

TADANO Oceania Pty Ltd.

4 / 12 Archimedes Street Darra
Queensland 4076
Australia
Phone: +61-7-3120-8750
Fax: +61-7-3120-8760
E-mail: pshelton@tadano.com.au

TADANO Korea Co. Ltd.

Dangok Bldg 2F, #642-7, Bokjeong-dong
Sujeong-gu, Seongnam-si, Gyeonggi-do
461-830, Korea
Phone: +82-2-714-1600
Fax: +82-2-3274-1304
E-mail: tadano@korea.com

TADANO MANTIS Corporation

1705 Columbia Avenue, Suite 200
Franklin, Tennessee USA 37065
Phone: +1-800-272-3325
Fax: +1-615-790-6803
E-mail: sales@mantisranes.com

TADANO Brasil Equipamentos de Elevacao Ltda.

Rua Dr. Djalma, Pinheiro Franco
829 Vila Santa Catarina. Sao Paulo-SP
Brazil
Phone: +55-11-4024-4118
E-mail: tadano@tadano.br

TADANO Asia Pte Ltd.

11 Tuas View Crescent
Multico Building
Singapore 637643
Phone: +65-6863-6901
Fax: +65-6863-6902
E-mail: Tdn-crane@tadanoasia.com

TADANO America Corporation

4242 West Greens Road
Houston, TX 77066, USA
Phone: +1-281-869-0030
Fax: +1-281-869-0040
E-mail: sales@tadano-cranes.com

TADANO Ltd. Beijing Office

Jing Guang Centre, Room 2905
Hu Jia Lou, Chao Yang Qu
Beijing, China
Phone: +86-10-6597-3210
Fax: +86-10-6597-3220
E-mail: beijing@tadano.co.jp

Taiwan TADANO Ltd.

16F, No. 39, Sec. 2 Twng-Hwa S. Rd.
Taipei
Taiwan
Phone: +886-2-2754-0252
Fax: +886-2-2709-2086
E-mail: tadano@ms18.hinet.net

Detaillierte Informationen über unsere internationalen Händler und Service Niederlassungen finden Sie im Internet.
For detailed information about our international distributor and service network, please refer to our homepages.
www.tadano.co.jp + www.tadanoaun.de + www.tadanoamerica.com + www.mantisranes.com

Herausgeber / Publisher:

TADANO FAUN GmbH

P.O.Box 10 02 64
91205 Lauf
Germany



BETTER SAFE THAN SORRY.

Accidents are always a risk when working with cranes. For this reason, we do everything we can to keep this risk as low as possible.

With our unique Lift Adjuster on the crane, a technical steering control system allows better control over difficult crane work. The Lift Adjuster is activated by the crane driver and helps considerably in keeping the load from swinging outwards when it is picked up, as normally occurs due to the strain displacement of the main boom.

This means the crane driver can focus his full attention on the load and what's around it, including the employees involved.

The Lift Adjuster offers particular advantages when the crane driver cannot see the load. The Lift Adjuster ensures gentle and swing-free lifting of the load, and therefore more safety for the valuable cargo and the people standing near it.

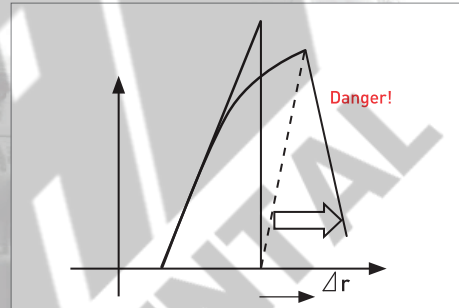

WITHOUT Lift Adjuster

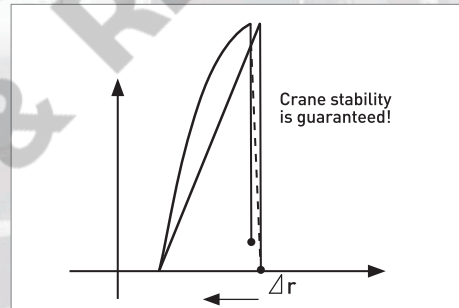

WITH Lift Adjuster

Even if the load and the load environment are in sight, the Lift Adjuster offers many advantages. The crane driver can dedicate all of his attention to the critical task of lifting the load, as he doesn't need to watch the crane equipment to maintain the load radius.

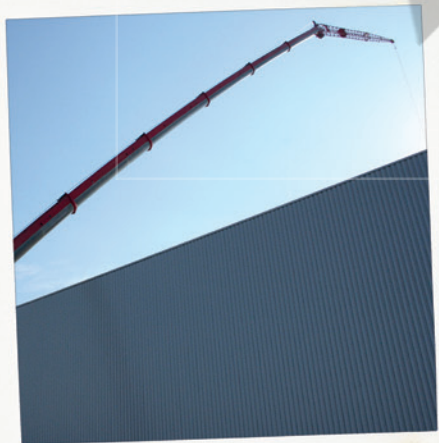

If the load and load environment are out of sight, the danger of crane accidents increases significantly.



The Lift Adjuster is activated at the touch of a button and automatically turns itself off again once the safe load torque has been reached.

WORK SAFELY WITH YOUR CRANE – USE OUR LIFT ADJUSTER.