

Upper Machinery

- UPPER FRAME:** All-welded, precision machined unit.
- TURNABLE BEARING WITH INTEGRAL RING GEAR:**
Outer race is bolted to upper frame, inner race with internal ring gear is bolted to lower frame. Swing pinions mesh with internal, integral ring gear. A machined surface is provided for mounting turntable bearing.
- CONTROL SYSTEM:** Remote controlled hydraulic servo for main hoist, aux. hoist, boom hoist and travel. Mechanical linkage type for swing. Working speed can be precisely controlled by lever stroke.
- PUMP CONTROL SYSTEM:** System reducing pump displacement enables both minute operation and saving energy.
- HYDRAULIC SYSTEM:** System combining variable displacement axial pumps and fixed displacement gear pumps provides both independent and combined operations of all functions.
- Main hoist/aux. hoist/boom hoist motor** — Axial piston motor with counterbalance valve.
 - Swing motor** — Axial piston motors.
 - Travel motor** — Axial piston motors with brake valves. Spring-applied/hydraulic-released multiple disc brakes are fitted.
 - Hydraulic oil reservoir** — 300 liter capacity.
- LOAD HOIST ASSEMBLY:** Front (main) and rear (aux.) operating drums. Each driven by the bi-directional, axial piston motor through reduction gear powering the rope drum in either direction for hoisting or lowering load. 3rd drum equipped as optional extra.
- Clutches** — Power hydraulic actuated, internal expanding, self adjusting 2-shoe type.
 - Brakes** — External contracting band type operated by foot pedal with locking latch. For crane mode, automatic brake (spring applied, hydraulically released) is applied when control lever in neutral position. For bucket mode, free-fall is available when control lever in neutral position.
 - Locks** — Electrically operated drum lock pawl.
- BOOM HOIST ASSEMBLY:** Driven by the bi-directional, axial piston motor through reduction gear powering the rope drum in either direction for hoisting or lowering boom.
- Brake** — Spring applied, hydraulically released external contracting band type.
 - Lock** — Electrically operated drum lock pawl.
- SWING:** Driven by two units of axial piston motors, through reduction gears.
- Brakes** — Brake is applied by spring and released by hydraulic cylinder.
 - Lock** — Mechanically operated pin connection frame lock.
 - Speed** — 2.5 rpm (High), 1.5 rpm (Low)
- OPERATOR'S CAB:** Full vision compartment with safety glass panels, the completely independent cab is insulated against noise and vibration.
- COUNTERWEIGHT:** Removable, 4 blocks mounted on rear of upper frame by bolts.

POWER UNIT:

Make & Model	Mitsubishi 6D22CT
Type	Water-cooled, 4-cycle diesel engine
No. of cylinders	6
Bore & Stroke	130 x 140mm
Displacement	11,149cc
Rated output	250 ps/2,200 rpm
Max. torque	105 kg-m/1,200 rpm
Fuel tank	450 liters

Lower Machinery

- LOWER FRAME:** All welded robust rolled steel, box construction.
- SIDE FRAMES:** All welded robust rolled steel. Connected to lower frame by links and pins. Retracted or extended by hydraulic cylinder.
- ROLLERS:** Heat treated, mounted on bushings with floating seals requiring no further lubrication. Double flange.
- Bottom** — 9 pcs. per side frame.
 - Top** — 3 pcs. per side frame.
- DRIVE SPROCKETS:** Heat treated, involute splined to drive shaft mounted on antifriction bearings.
- IDLERS:** Heat treated, mounted on bushings with floating seals requiring no further lubrication.
- TRACKS:** Heat treated, one lug type, multiple hinged shoes, 45 pcs. per side frame.
- Shoe width** — 810mm (standard)
965mm (optional extra).
 - Note: with 965mm shoe, side frame is not retracted.
- TRACK TENSION ADJUSTER:** Adjusted by hydraulic cylinders at the idler blocks. Tension can be automatically released when abnormal load occurred on tracks.
- TRAVEL AND STEER:** Axial piston motor with reduction gear is located at inner drive end of each crawler side frame. Each track is driven simultaneously or individually for straight-line travel, or pivot turn, or the tracks can be counter-rotated for spin turns.
- Brake** — Spring applied, hydraulically released multiple disc brakes applied automatically when control lever in neutral position.
 - Speed** — Four speed range.
1.3/0.65km/h . . . Pump control "OFF" (ordinally)
0.3/0.15km/h . . . Pump control "ON"

General Dimensions

- A : Height over low gantry unit 3.375m
- A' : Height over high gantry unit 6.380m
- B : Height of cab 3.395m
- C : Counterweight ground clearance 1.400m
- D : Radius of rear end 5.000m
- E : Center of rotation to boom foot pin 1.400m
- F : Center to center distance of tumbler 5.340m
- G : Overall length of crawler 6.415m
- H : Height from ground to boom foot pin 2.275m
- I : Overall width of house 3.400m
- J : Ground clearance 0.535m
- K : Center to center distance of crawler
extended 4.000m
retracted 2.660m
- L : Overall width of crawler
extended 4.810m
retracted 3.470m
- M : Shoe width 0.810m
- N : Height of shoe 1.160m
- O : Tail swing radius at low gantry 5.920m

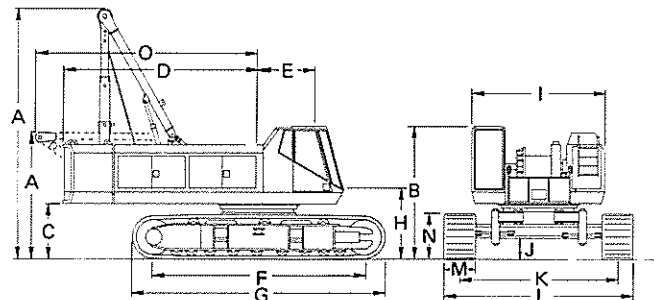

We are constantly improving our products and therefore reserve the right to change designs and specifications without notice.

SUMITOMO (S.H.I.) CONSTRUCTION MACHINERY CO., LTD.

K & T Bldg. 1-28-44, Shinkawa, Chuo-ku, Tokyo 104, Japan

Phone: (03) 3297-8833 Fax: (03) 3297-9849 Telex: J 27961 SHIKENKI

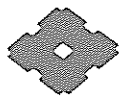

CRANE BOOMS: Lattice construction; round tubular main chords, alloy hi-ten steel, with bracing of round steel tubing.

- Boom connections In-line pin connections.
- Basic boom Two-piece, 12.20m basic length; 6.10m base and 6.10m top section; 1.55m deep and 1.55m wide at connections.
- Boom point machinery Four head sheaves mounted on antifriction bearings.
- Boom extensions Available in 3.05m, 6.10m and 9.15m lengths with pendants. Maximum boom length 57.90m.
- Jib Two-piece; 9.15m basic length with 4.57m long base and top sections, 0.61m deep and 0.81m wide at connections.
- Jib extensions Available in 4.57m jib extensions. Maximum jib length 18.30m.
- Boom plus jib length 48.80m + 18.30m.
51.85m + 13.70m.

HOOK BLOCK:

- 80t, four sheaves Standard.
- 50t, two sheaves Optional extra.
- 30t, one sheave Optional extra.
- 10t, no sheave Standard for jib.

GANTRY: Retractable high gantry.

LINE SPEED:

Drums	Root dia.	Type	Line speed (Hoisting, Lowering)		Cable dia.
			Pump control "OFF" (Ordinary)	Pump control "ON"	
Main hoist (Front)	546mm	Parallel grooved	High 60 m/min Low 30 m/min	High 15 m/min Low 7.5 m/min	26mm
Aux. hoist (Rear)	546mm	Parallel grooved	High 60 m/min Low 30 m/min	High 15 m/min Low 7.5 m/min	26mm
3rd drum (option)	320mm	Parallel grooved	60 m/min	15 m/min	16mm
Boom hoist	420mm	Parallel grooved	40 m/min	10 m/min	20mm

HOIST REEVING:

No. of parts of line	Main hoist							
	8	7	6	5	4	3	2	1
Max. load (t)	80.0	70.6	61.1	51.5	41.6	31.5	21.2	10.7

WORKING WEIGHT AND GROUND PRESSURE:

Shoe width	Weight	Pressure
810mm	74.0t	0.80 kg/cm ²
965mm (Opt)	75.5t	0.68 kg/cm ²

With basic boom and counterweight A, B, C and D.

Weight without counterweight and front attachment: approx. 48t.

COUNTERWEIGHT: A (5.1t), B (6.1t), C (5.1t), D (3.7t)
Total . . . 20.0t

SAFETY DEVICE: Hook over hoist limiting device, boom over hoist limiting device, boom angle indicator, boom back stop, drum pawl lock for main, aux. and boom hoist drum, safety valve in hydraulic circuit, swing lock, swing alarm, load moment limiter (optional extra).

GRADEABILITY: 30% (17°)
with basic boom and counterweight.

We are constantly improving our products and therefore reserve the right to change designs and specifications without notice.

SUMITOMO (S.H.I.) CONSTRUCTION MACHINERY CO., LTD.

K & T Bldg. 1-28-44, Shinkawa, Chuo-ku, Tokyo 104, Japan

LS-218RH₅ CRANE CAPACITIES (WITH CRANE BOOM):

(in metric tons)

Working radius (m)	Boom length (m)															
	12.20	15.25	18.30	21.35	24.40	27.45	30.50	33.55	36.60	39.65	42.70	45.75	48.80	51.85	54.90	57.90
3.8	80.0															
4.0	80.0															
4.5	72.0	68.8														
5.0	58.3	58.3	58.3													
6.0	43.3	43.3	43.3	43.3	43.2											
7.0	34.4	34.4	34.4	34.3	34.2	34.2										
8.0	28.4	28.4	28.3	28.3	28.2	28.2	28.1	28.0								
9.0	24.2	24.1	24.1	24.0	23.9	23.9	23.9	23.8	23.7	23.6						
10.0	21.0	20.9	20.8	20.8	20.7	20.6	20.6	20.5	20.4	20.3	20.3	20.2				
12.0	16.5	16.4	16.4	16.3	16.2	16.1	16.1	16.0	15.9	15.8	15.8	15.7	15.6	15.5	15.4	
14.0		13.4	13.3	13.2	13.1	13.1	13.0	12.9	12.8	12.8	12.7	12.6	12.5	12.5	12.4	12.3
16.0			11.2	11.1	11.0	11.0	10.9	10.8	10.7	10.6	10.5	10.4	10.3	10.2	10.1	10.0
18.0				9.5	9.4	9.4	9.3	9.2	9.1	9.0	8.9	8.8	8.7	8.6	8.5	8.4
20.0				8.3	8.2	8.1	8.0	7.9	7.8	7.7	7.6	7.5	7.5	7.4	7.3	7.2
22.0					7.2	7.2	7.1	7.0	6.9	6.8	6.7	6.6	6.5	6.4	6.3	6.1
24.0						6.3	6.2	6.1	6.0	5.9	5.8	5.7	5.6	5.5	5.4	5.3
26.0							5.5	5.4	5.3	5.2	5.1	5.0	5.0	4.9	4.8	4.6
28.0							5.0	4.9	4.8	4.7	4.6	4.5	4.4	4.3	4.2	4.0
30.0								4.4	4.3	4.2	4.1	4.0	3.9	3.7	3.6	3.5
32.0									3.8	3.7	3.6	3.5	3.4	3.3	3.2	3.1
34.0										3.3	3.2	3.1	3.0	2.9	2.8	2.7
36.0										3.0	2.9	2.8	2.7	2.6	2.5	2.4
38.0											2.6	2.5	2.4	2.3	2.2	2.1

Notes:

- Capacities shown are in metric tons and are based on 75% of minimum tipping loads— over the side — with machine standing level on firm supporting surface under ideal job conditions. Deductions from the lifting crane capacities must be made for weight of hook block.

Kind of hook block (t)	80	50	30	10
Weight of hook block (t)	1.10	0.84	0.64	0.40

- When operating of the main boom peak sheaves with jib on boom the following deductions in machine lifting capacities must be made.

Jib length (m)	9.15	13.70	18.30
Weight to be deducted (t)	1.50	2.10	2.80

- High gantry is required and side frames must be extended for all operating conditions.

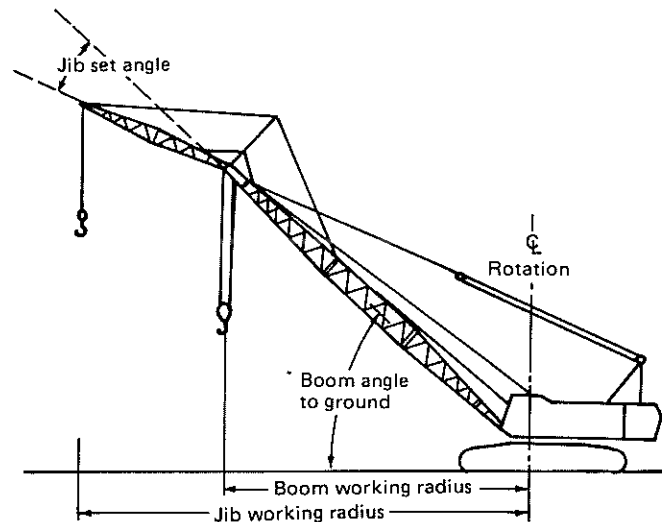

LS-218RH₅ JIB CAPACITIES:

(in metric tons)

Jib length (m)	Jib set angle	Max. jib Capacities
9.15	10°	10.0
	30°	5.0
13.70	10°	8.0
	30°	5.0
18.30	10°	4.5
	30°	3.2

Notes:

- The jib capacities are equal to the crane lifting capacities of the main boom on which the jib is fixed except that they are restricted by the maximum jib capacities shown left.
- Jib working radius does not exceed the working radius of the main boom which fits the jib.
- Deductions from the jib capacities must be made for weight of jib hook block (0.4 t).
- Available boom length to attach the jib is from 36.60m to 51.85m. The maximum jib length is 18.30m.
- The jib set angle to boom must not exceed 30°

Crane 80 metric tons

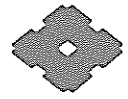

LS-218RH₅ CRANE WORKING RANGES:

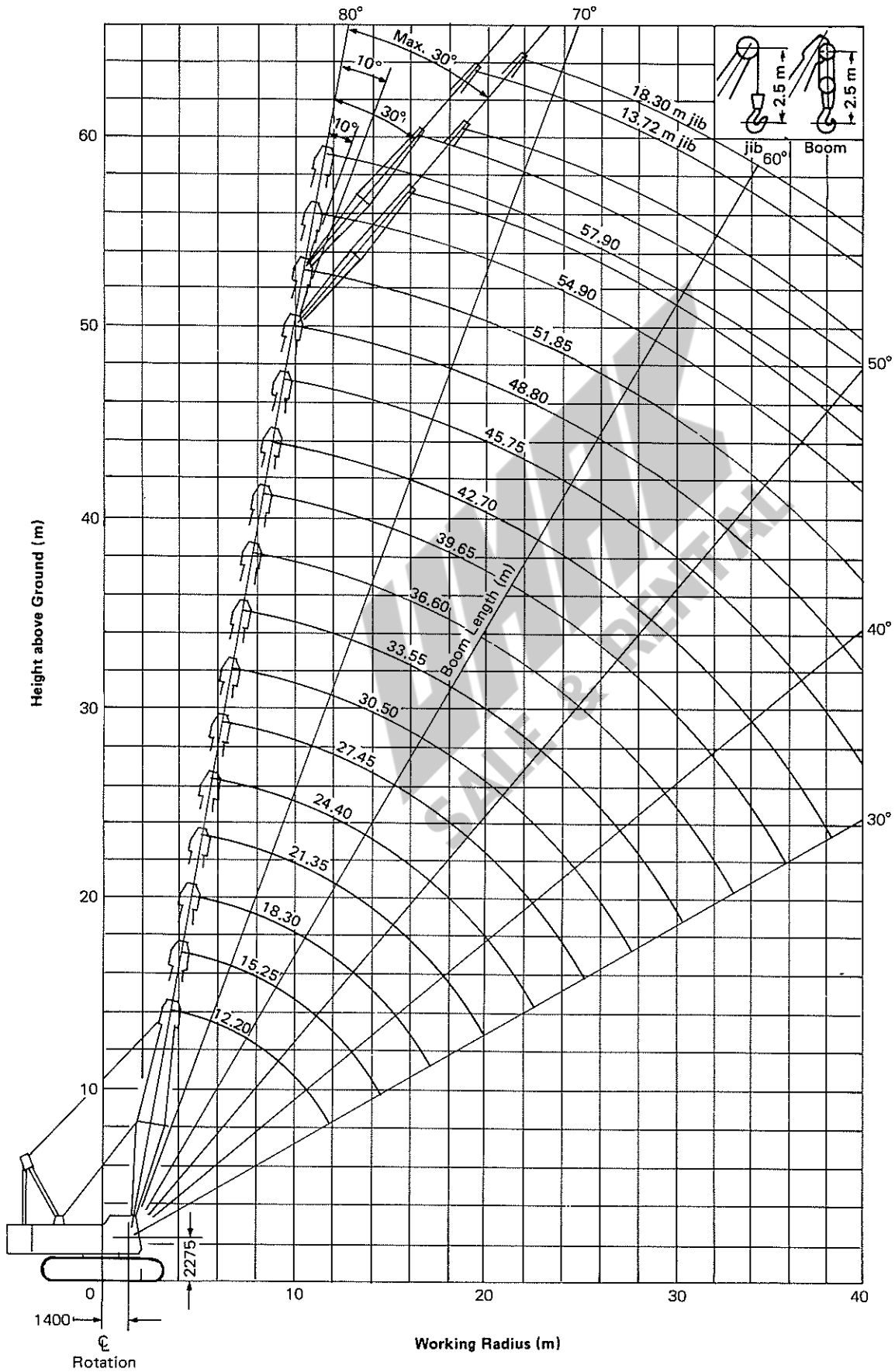

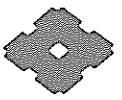

CLAMSHELL BOOMS: Lattice construction; round tubular main chords, alloy hi-ten steel, with bracing of round steel tubing.

Boom connections . . . In-line pin connections.
Basic boom . . . Three-piece, 15.25m basic length; 6.10m base, 3.05m extension and 6.10m top section; 1.55m deep and 1.55m wide at connections.

Boom point machinery . . . Four head sheaves mounted on anti-friction bearings.

Boom extensions . . . Available in 3.05m, 6.10m and 9.15m lengths with pendants.

GANTRY: Retractable high gantry

MAXIMUM CLAMSHELL RATING: 10.0t

LINE SPEED:

Drums	Root dia.	Type	Line speed (Closing, Holding)		Cable dia.
			Pump control "OFF" (Ordinary)	Pump control "ON"	
Holding	546mm	Parallel grooved	High 60 m/min Low 30 m/min	High 15 m/min Low 7.5 m/min	26mm
Closing	546mm	Parallel grooved	High 60 m/min Low 30 m/min	High 15 m/min Low 7.5 m/min	26mm
3rd drum (Option)	320mm	Parallel grooved	60 m/min	15 m/min	16mm
Boom hoist	420mm	Parallel grooved	40 m/min	10 m/min	20mm

Hoisting line speed varies with load.

GANTRY: Retractable high gantry

WORKING WEIGHT AND GROUND PRESSURE:

Shoe width	Weight	Pressure
810 mm	80.0 t	0.86 kg/cm ²

With basic boom, 2.5 m³ bucket and counterweight A, B, C, D.
 Weight without counterweight and front attachment: approx. 48t

LS-218RH5 CLAMSHELL CAPACITIES AND WORKING RANGES:
 (in metric tons)

Boom length (m)								
15.25			18.3			21.35		
R (m)	A (°)	L (t)	R (m)	A (°)	L (t)	R (m)	A (°)	L (t)
8.0	66.9	10.0						
9.0	62.6	10.0	9.0	67.6	10.0			
10.0	58.2	10.0	10.0	64.1	10.0	10.0	68.1	10.0
11.0	53.5	10.0	11.0	60.5	10.0	11.0	65.1	10.0
12.0	48.5	10.0	12.0	56.7	10.0	12.0	62.0	10.0
14.0	36.9	10.0	14.0	48.6	10.0	14.0	55.6	10.0
16.0			16.0	39.2	9.6	16.0	48.7	9.6
18.0						18.0	40.8	8.2

R: Working radius A: Boom angle L: Rated load

Notes:

1. Following weight of bucket plus load should not exceed above rated loads.

Bucket capacity	2.0m ³	2.5m ³	3.0m ³
Bucket weight	4.5t	5.5t	6.5t

2. Boom length shall not exceed 21.35m.

3. Apparent specific gravity of lifting material:
 Earth1.7~1.8t/m³
 Gravel.....1.8~2.0t/m³

4. High gantry is required and side frames must be extended for all operating conditions.

COUNTERWEIGHT: A (5.1t), B (6.1t), C (5.1t), D (3.7t)
 Total . . . 20.0t

SAFETY DEVICE: Boom over hoist limiting device, drum pawl lock for closing, holding and boom hoist drum, swing lock, safety valve in hydraulic circuit, boom angle indicator, boom back stop.

TAGLINE WINDER: Spring-wound, drum-type mounted on boom, double stage type Standard
 Spring-wound, drum-type mounted on boom, triple stage type Optional extra
 Hydraulic type mounted in front of the revolving frame Optional extra

GRADEABILITY: 30% (17°)
 with basic boom, 2.5m³ bucket and counterweight A, B, C, D.

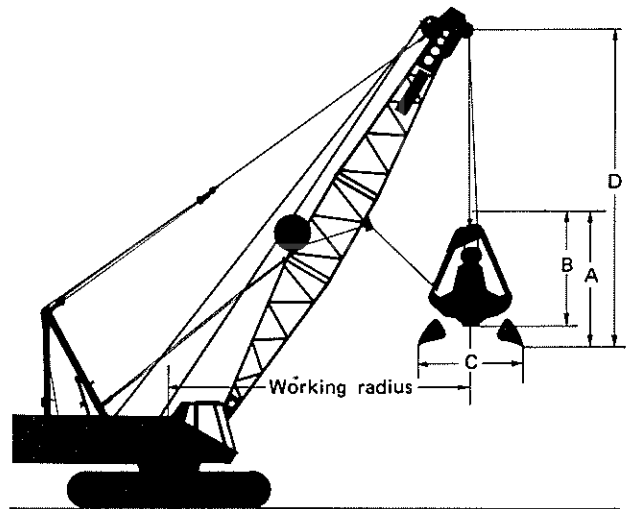

(in meters)

	Bucket capacity	2.0m ³	2.5m ³	3.0m ³ *
A	Bucket overall height (opened)	4.52	4.37	5.37
B	Bucket overall height (closed)	3.69	3.46	4.36
C	Bucket opening width	3.24	3.65	3.65
D	Bucket clearance	7.4	7.4	7.4

* Light duty service

We are constantly improving our products and therefore reserve the right to change designs and specifications without notice.

SUMITOMO (S.H.I.) CONSTRUCTION MACHINERY CO., LTD.

K & T Bldg. 1-28-44, Shinkawa, Chuo-ku, Tokyo 104, Japan

Phone: (03) 3297-8833 Fax: (03) 3297-9849 Telex: J 27961 SHIKENKI

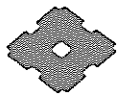

TOWER BOOMS: Lattice constructions; round tubular main chords, alloy, hi-ten steel, with bracing of round steel tubing.

Boom connections In-line pin connections.

Basic boom Three-piece 12.20m (40') basic length; 6.10m (20') base, 0.45m (1½') extension and 5.65m (13½') top section. 1.55m (5'1") deep and 1.55m (5'1") wide at connections.

Boom point machinery Four head sheaves mounted on antifriction bearings.

Tower boom extensions Available in 3.05m (10'), 6.10m (20') and 9.15m (30') lengths with pendants. Maximum boom length 57.90m (190').

Jib Two-piece; 9.15m (30') basic length with 4.57m (15') long base and top sections. 0.61m (2') deep and 0.81m (2'8") wide at connections.

Jib extensions Available in 4.57m (15') jib extension. Maximum jib length 18.30m (60').

Tower boom plus jib 48.80m (160') + 18.30m (60') length
51.85m (170') + 13.70m (45')

HOOK BLOCKS:

80t (176,400 lbs), four sheaves Standard
50t (110,200 lbs), two sheaves Optional extra
30t (66,100 lbs), one sheave Optional extra
10t (22,000 lbs), no sheave Standard for jib
GANTRY: Retractable high gantry.

LS-218RH5 CRANE CAPACITIES (WITH TOWER BOOM):

Unit: metric tons (in 1,000 lbs)

Working radius m (ft. in.)	Boom length (m)															
	12.20 (40')	15.25 (50')	18.30 (60')	21.35 (70')	24.40 (80')	27.45 (90')	30.50 (100')	33.55 (110')	36.60 (120')	39.65 (130')	42.70 (140')	45.75 (150')	48.80 (160')	51.85 (170')	54.90 (180')	57.90 (190')
3.8	80.0 (176.4)															
4.0	80.0 (176.4)															
4.5	66.3 (146.2)	66.3 (146.2)														
5.0	55.1 (121.5)	55.0 (121.3)	54.9 (121.0)													
6.0	41.5 (91.5)	41.4 (91.3)	41.3 (91.1)	41.3 (91.1)	41.2 (90.8)											
7.0	33.3 (73.4)	33.2 (73.2)	33.1 (73.0)	33.0 (72.8)	32.9 (72.5)	32.8 (72.3)										
8.0	27.3 (60.2)	27.2 (60.0)	27.1 (59.8)	27.0 (59.5)	26.9 (59.3)	26.8 (59.1)	26.7 (58.9)	26.6 (58.7)								
9.0	23.3 (51.4)	23.2 (51.2)	23.1 (50.9)	23.0 (50.7)	22.9 (50.5)	22.8 (50.3)	22.7 (50.1)	22.6 (49.8)	22.5 (49.6)							
10.0	20.2 (44.5)	20.1 (44.3)	20.0 (44.1)	20.0 (44.1)	19.9 (43.9)	19.9 (43.9)	19.8 (43.7)	19.7 (43.4)	19.6 (43.2)	19.5 (43.0)	19.4 (42.8)					
12.0	15.8 (34.8)	15.7 (34.6)	15.6 (34.4)	15.6 (34.4)	15.6 (34.4)	15.5 (34.2)	15.5 (34.2)	15.4 (34.0)	15.3 (33.7)	15.2 (33.5)	15.1 (33.3)	15.0 (33.1)	14.9 (32.9)	14.8 (32.6)	14.7 (32.4)	
14.0		12.8 (28.2)	12.8 (28.2)	12.8 (28.2)	12.8 (28.2)	12.7 (28.0)	12.6 (27.8)	12.5 (27.6)	12.4 (27.3)	12.3 (27.1)	12.2 (26.9)	12.1 (26.7)	12.0 (26.5)	11.9 (26.2)	11.8 (26.0)	11.7 (25.8)
16.0			10.7 (23.6)	10.7 (23.6)	10.7 (23.6)	10.6 (23.4)	10.6 (23.3)	10.5 (23.2)	10.4 (22.9)	10.3 (22.7)	10.2 (22.5)	10.1 (22.3)	10.0 (22.1)	9.9 (21.8)	9.8 (21.6)	9.7 (21.4)
18.0				9.1 (20.1)	9.0 (19.8)	9.0 (19.8)	8.9 (19.6)	8.8 (19.4)	8.8 (19.2)	8.7 (19.2)	8.6 (19.0)	8.5 (18.7)	8.4 (18.5)	8.3 (18.3)	8.2 (18.1)	8.1 (17.9)
20.0					7.9 (17.4)	7.9 (17.4)	7.8 (17.2)	7.7 (17.0)	7.6 (16.8)	7.5 (16.5)	7.4 (16.3)	7.3 (16.1)	7.2 (15.9)	7.1 (15.7)	7.0 (15.4)	6.9 (15.2)
22.0						6.9 (15.2)	6.8 (15.0)	6.7 (14.8)	6.6 (14.5)	6.5 (14.3)	6.4 (14.1)	6.3 (13.9)	6.2 (13.7)	6.1 (13.5)	6.0 (13.2)	5.9 (13.0)
24.0							6.0 (13.2)	5.9 (13.0)	5.8 (12.8)	5.7 (12.6)	5.6 (12.3)	5.5 (12.1)	5.4 (11.9)	5.3 (11.7)	5.2 (11.5)	5.1 (11.2)
26.0								5.2 (11.5)	5.1 (11.2)	5.0 (11.0)	4.9 (10.8)	4.8 (10.4)	4.7 (10.1)	4.6 (9.9)	4.5 (9.7)	4.4 (9.5)
28.0									4.7 (10.4)	4.6 (10.1)	4.5 (9.9)	4.4 (9.7)	4.3 (9.5)	4.2 (9.3)	4.0 (8.8)	3.8 (8.4)
30.0										4.1 (9.0)	4.0 (8.8)	3.9 (8.6)	3.8 (8.4)	3.7 (8.4)	3.5 (7.7)	3.0 (6.6)
32.0											3.6 (7.9)	3.5 (7.7)	3.4 (7.5)	3.3 (7.3)	3.0 (6.6)	2.4 (5.3)
34.0												3.0 (6.6)	3.0 (6.6)	2.8 (6.2)	2.5 (5.5)	2.2 (4.9)
36.0													2.7 (6.0)	2.6 (5.7)	2.4 (5.3)	2.1 (4.6)
38.0														2.2 (4.9)	2.0 (4.4)	1.7 (3.7)

Notes:

1. Capacities shown are based on 75% of minimum tipping loads — over the side — with machine standing level on firm supporting surface under ideal job conditions. Deductions from the lifting crane capacities must be made for weight of hook block.

Kind of hook block t (lbs)	80 (176,400)	50 (110,200)	30 (66,100)	10 (22,000)
Weight of hook block t (lbs)	1.10 (2,400)	0.84 (1,900)	0.64 (1,400)	0.40 (900)

- When operating of the main boom peak sheaves with jib on boom the following deductions in machine lifting capacities must be made.
- High gantry is required and side frames must be extended for all operating conditions.

LS-218RH5 JIB CAPACITIES

Unit: metric tons (lbs)

Jib length m (ft)	9.15 (30')	13.70 (45')	18.30 (60')	Short jib
Jib set angle (°)				
10	10.0 (22,000)	8.0 (17,700)	4.5 (9,900)	See note
30	5.0 (11,000)	5.0 (11,000)	3.2 (7,100)	See note
Weight to be deducted t (lbs)	1.50 (3,300)	2.10 (4,600)	2.80 (6,200)	0.30 (660)

LS-218RH5 SHORT JIB LIFTING CAPACITY

Notes:

- Rated load of auxiliary hook is equal to the main boom lifting capacity at each working radius minus 0.3 ton subject to maximum 10 ton load. Deduction from the lifting capacity of auxiliary hook must be made for weight of main hook, aux. hook and other entire sling tools.
- Main hook lifting capacity when equipped short jib shall be rated load of main boom at each working radius minus 0.3 ton. Deduction from the lifting capacities of main hook must be made for weight of main hook, aux. hook and other entire sling tools.
- Short jib is applicable for main boom length from 12.2m to 54.8m.



TOWER BOOMS: Lattice construction; round tubular main chords, alloy, hi-ten, steel, with bracing of round steel tubing.

- Tower connections In-line pin connections.
- Basic tower Five-piece, 22.85m (75') basic length; 6.10m (20') base, one 3.05m (10'), one 6.10m (20') (expand type), one 6.10m (20') extensions and 1.5m (5') cap sections; 1.55m (5'1") deep and 1.55m (5'1") wide at connections.
- Tower extensions Available in 3.05m (10'), 6.10m (20') and 9.15m (30') length with pendants. Maximum tower length 44.20m (145').
- Basic tower jib Three-piece, 19.10m (62'8") basic length; 7.00m (23') base, one 6.00m (19'8") Taper extension and 6.00m(19'8") top sections; 1.00m (3'3") deep and 1.00m (3'3") wide at connections.
- Tower jib point machinery One head sheave mounted on antifriction bearings.
- Tower jib extensions Available in 3.00m (9'10") and 6.00m (19'8") length. Maximum tower jib length 34.10m (111'11").
- Maximum tower plus 44.20m (145') tower + 34.10m (111'11") tower jib.
tower jib length

HOOK BLOCKS:

- 15t (33,100 lbs) one sheave . . . Standard
- 10t (22,000 lbs) no sheave Optional extra.

GANTRY: Retractable high gantry.

LINE SPEED:

Drums	Root dia.	Type	Line speed (Hoisting Lowering)		Cable dia.
			Pump control "OFF" (Ordinary)	Pump control "ON"	
Main hoist (Front)	546mm (21.496")	Parallel grooved	High 60m/min(197ft./min) Low 30m/min(98ft/min)	High 15m/min(49ft/min) Low 7.5m/min(25ft/min)	26mm(1.024")
Tower jib hoist (Rear)	546mm (21.496")	Parallel grooved	30m/min(98ft/min)	7.5m/min(25ft/min)	26mm(1.024")
Tower hoist (Boom hoist)	420mm (16.535")	Parallel grooved	40m/min(131ft/min)	10m/min(33ft/min)	20mm(0.787")

Notes:

1. Above line speed is based on first layer.
2. Above hoisting line speed varies with load.

HOIST REEVING:

No. of parts of line	2	1
Max. load t (lbs)	15 (33,100)	10 (22,000)

WORKING WEIGHT AND GROUND PRESSURE:

Shoe width	Weight	Pressure
810mm (2'8")	84.6 (186,500)	0.91 (12.9)
* 965mm (3'2")	86.1 (189,800)	0.96 (13.7)

* optional

With basic tower plus basic tower jib and counterweights. A, B, C, D, E and F.
Weight without counterweight and front attachment: approx. 48t (105,800 lbs).

COUNTERWEIGHT: A 5.1t (11,200 lbs), B 6.1t (13,400), C 5.1t (11,200 lbs), D 3.7t (8,200 lbs), E 2.0t (4,400 lbs), F 1.0t (2,200 lbs) 2 pcs.
Total 24.0 t (55,100 lbs)

SAFETY DEVICE: Anti two block device, tower over hoist limiting device, tower angle indicator, tower back stop, drum pawl lock for main, tower jib, and tower hoist drum, safety valve in hydraulic circuit, swing lock, swing alarm, automatic overload preventing device (optional extra).

NOTE: Crane boom must not be used for tower configuration.

We are constantly improving our products and therefore reserve the right to change designs and specifications without notice.

SUMITOMO (S.H.I.) CONSTRUCTION MACHINERY CO., LTD.

K & T Bldg. 1-28-44, Shinkawa, Chuo-ku, Tokyo 104, Japan

LS-218RH5 TOWER CRANE CAPACITIES:

Unit: metric tons (lbs)

Tower length m (ft. in.)	22.85 ~ 44.20 (75') ~ (145')		25.90 ~ 44.20 (85') ~ (145')		28.95 ~ 44.20 (95') ~ (145')		32.00 ~ 44.20 (105') ~ (145')		35.05 ~ 44.20 (115') ~ (145')		38.10 ~ 44.20 (125') ~ (145')	
Jib length m (ft. in.)	19.10 (62'8")		22.10 (72'6")		25.10 (82'4")		28.10 (92'2")		31.10 (102'1")		34.10 (111'11")	
Working radius m (ft. in.)	Tower jib angle (°)	Load	Tower jib angle (°)	Load	Tower jib angle (°)	Load	Tower jib angle (°)	Load	Tower jib angle (°)	Load	Tower jib angle (°)	Load
9.7 (31'10")	70	15.0 (33,100)										
10.0 (32'10")	69	15.0 (33,100)	70	15.0 (33,100)/10.7								
11.0 (36'1")	66	15.0 (33,100)	69	15.0 (33,100)	70	15.0 (33,100)/11.7						
12.0 (39'5")	63	15.0 (33,100)	66	15.0 (33,100)	69	15.0 (33,100)	70	15.0 (33,100)/12.8				
13.3 (43'8")	58	15.0 (33,100)	63	15.0 (33,100)	66	15.0 (33,100)	69	15.0 (33,100)	70	12.5 (27,600)/13.8		
15.0 (49'3")	52	12.5 (27,600)	58	12.5 (27,600)	62	12.5 (27,600)	65	12.5 (27,600)	68	12.3 (27,100)	70	10.5 (23,100)
16.0 (52'6")	48	11.5 (25,400)	55	11.5 (25,400)	59	11.5 (25,400)	63	11.5 (25,400)	66	11.5 (25,400)	68	10.1 (22,300)
18.0 (59'1")	39	10.0 (22,000)	48	10.0 (22,000)	54	10.0 (22,000)	58	10.0 (22,000)	62	10.0 (22,000)	64	9.4 (20,700)
20.0 (65'7")	25	8.6 (19,000)/20.4	40	8.8 (19,400)	48	8.8 (19,400)	53	8.8 (19,400)	57	8.8 (19,400)	60	8.6 (19,000)
22.0 (72'2")			31	7.9 (17,400)	41	7.9 (17,400)	46	7.9 (17,400)	53	7.9 (17,400)	56	7.9 (17,400)
24.0 (78'9")			25	7.5 (16,500)/23.1	34	7.1 (15,700)	42	7.1 (15,700)	48	7.1 (15,700)	52	7.1 (15,700)
26.0 (85'4")					25	6.5 (14,300)/25.8	36	6.4 (14,300)	43	6.4 (14,300)	48	6.4 (14,300)
28.0 (91'10")							28	5.75 (12,700)	37	5.75 (12,700)	43	5.75 (12,700)
30.0 (98'5")							25	5.6 (12,400)/28.6	30	5.25 (11,600)	38	5.25 (11,600)
32.0 (105")									25	5.0 (11,000)/31.3	32	4.9 (10,800)
34.0 (111'7")											25	4.6 (10,100)

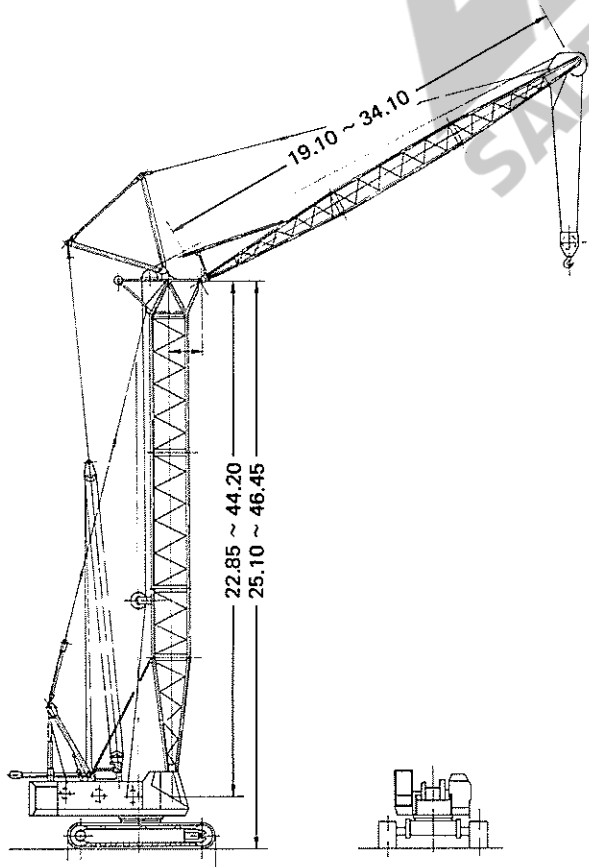

Notes:

- Capacity shown are based on structural strength and machine standing level on firm supporting surface under ideal job conditions.
- Deductions from the tower crane capacities must be made for following weight of hook block.

Kind of hook block t (lbs)	15 (33,100)	10 (22,000)
Weight of hook block t (lbs)	0.8 (1,800)	0.4 (900)

- High gantry is required and side frames must be extended for all operating conditions.

LS-218RH5 TOWER AND TOWER JIB COMBINATION:

○ : Available, X : Not available

Tower jib length m (ft. in.)	19.10 (62'8")	22.10 (72'6")	25.10 (82'4")	28.10 (92'2")	31.10 (102'1")	34.10 (111'11")
22.87(75')	○	X	X	X	X	X
25.90(85')	○	○	X	X	X	X
28.95(95')	○	○	○	X	X	X
32.00(105')	○	○	○	○	X	X
35.05(115')	○	○	○	○	○	X
38.10(125')	○	○	○	○	○	○
41.15(135')	○	○	○	○	○	○
44.20(145')	○	○	○	○	○	○

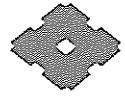

LS-218RH5 TOWER CRANE WORKING RANGES:

