

# KOBELCO

# CK1600-II

## HYDRAULIC CRAWLER CRANE



**Max. Lifting Capacity: 160 US Tons**  
**Max. Boom Length: 250 ft**  
**Max. Boom + Jib Length: 200 ft + 100 ft**



# SPECIFICATIONS FOR CK1600-II CRAWLER CRANE

The Kobelco CK1600-II Crawler Crane is designed from the ground up for reliable operation, convenient maintenance and easy transport.

Please consult your Kobelco distributor for additional information regarding specifications, operating parameters and maintenance requirements.

## 1. GENERAL DESCRIPTION

<b>Type</b>	Crawler mounted, fully revolving
<b>Maximum lifting capacity</b>	320,000 lbs (145,200 kg) (at 15' operating radius, with 50' boom)
<b>Basic boom length</b>	50' (15.2 m)
<b>Maximum boom length</b>	250' (76.2 m)
<b>Maximum boom &amp; jib length</b>	200' + 100' (61.0 m + 30.5 m)

<b>Hoist line speed (front and rear drum)</b>	390 ~ 10 ft/min (120 ~ 3 m/min)
<b>Lowering line speed (front and rear drum)</b>	390 ~ 10 ft/min (120 ~ 3 m/min)
<b>Boom hoist line speed</b>	157 ~ 7 ft/min (48 ~ 2 m/min)
<b>Boom lowering line speed</b>	2 minutes: 250 ft (76.2 m) boom raise 0 to 80 degree 157 ~ 7 ft/min (48 ~ 2 m/min)

## 2. GENERAL DIMENSIONS

<b>Height to top of cab</b>	11' 9" (3.58 m)
<b>Width of upper machine with operator's cab</b>	10' 6" (3.20 m)
<b>Radius of rear end (counterweight)</b>	18' 1" (5.50 m)
<b>Counterweight ground clearance</b>	4' 5" (1.34 m)
<b>Center of rotation to boom foot pin</b>	4' 7" (1.40 m)
<b>Height from ground to boom foot pin</b>	8' 4" (2.53 m)
<b>Height over gantry (raised)</b>	25' 11" (7.89 m)
<b>Overall length of crawler</b>	25' 11" (7.90 m)
<b>Center to center of tumblers</b>	22' 8" (6.89 m)
<b>Overall width of crawlers</b>	21' 9" (6.62 m)
<b>Shoe width</b>	48" (1.22 m)
<b>Ground clearance of carbody</b>	19" (0.48 m)

<b>Swing speed</b>	2.1 rpm (2.1 min <sup>-1</sup> )
<b>Travel speed (High / Low)</b>	0.81 / 0.56 mph (1.3 / 0.9 km/hour)

## 3. WORKING WEIGHT

Type of Counterweight	Light	Standard
Working Weight	273,000 lbs (124,000 kg)	306,000 lbs (139,000 kg)
Ground Bearing Pressure	10.5 psi	11.7 psi
Gradeability	30%	30%

Calculations to determine working weight ground bearing pressure and gradeability include the weight of the base machine, 50' boom and hook block.

Type of Counterweight:  
 Light = 105,820 lbs (48,000 kg) Counterweight without carbody weight.  
 Standard = 116,840 lbs (53,000 kg) Counterweight with carbody weight.

## 4. WORKING SPEED

Line speeds based on single line, no load and first layer of rope on the drum.

## 5. UPPER MACHINERY

### 5.1 Power plant

<b>Diesel engine, make and model</b>	Hino P11C-UN (Comply with EPA "Tier 3")
<b>No. of cylinders</b>	6
<b>Bore X stroke</b>	4-13/16" X 5-7/8" (122 mm X 150 mm)
<b>Cycles</b>	4
<b>Total displacement</b>	642 cu.in (10,520 cm <sup>3</sup> )
<b>Rated output SAE GROSS</b>	331 HP / 2,000 rpm (247 kW / 2,000 min <sup>-1</sup> )
<b>Maximum torque</b>	959 lbs-ft / 1,500 rpm (1,300 Nm / 1,500 min <sup>-1</sup> )
<b>Starter</b>	24 Volts / 6.0 kW
<b>Alternator</b>	24 Volts / 50 Amp
<b>Batteries</b>	Two 12 volt, 170 AH/20HR capacity series connected.
<b>Radiator</b>	Corrugated type core, thermostatically controlled.
<b>Throttle</b>	Twist grip type hand throttle, electrically controlled.
<b>Air cleaner</b>	Dry type with replaceable paper element.
<b>Fuel tank capacity</b>	106 US gal. (400 liters)
<b>Lube oil filter</b>	Full flow and by-pass type with element type.
<b>Fuel filter</b>	Replaceable paper element.
<b>Approximate fuel consumption</b>	0.362 lb / HP-hr (220 g / kW-hr) 17.3 US gal. / hr at 100 % HP

## 5.2 Hydraulic pumps

All driven from heavy duty pump drive.

### Load hoist and propel

2 Piston pumps, max flow rate 66.5 US gal./min x 2  
(252 ℓ/min x 2)

### Boom Hoist

1 Piston pump, max flow rate 66.5 US gal./min  
(252 ℓ/min)

### Swing

1 Piston pump, max flow rate 46.2 US gal./min  
(175 ℓ/min)

### Control system and auxiliary

2 Gear pumps, max flow rate  
16.1 US gal./min x 10.6 US gal (61 l/min x 40 ℓ/min)

### Brake cooling system

2 Gear pumps, max flow rate 19.3 US gal./min x 2  
(73 ℓ/min x 2)

## 5.3 Counterweight

### Light Weight

one (1) base counterweight (A) and eight (8) side counterweights (B) 105,820 lbs(48,000 kg)

### Standard Weight

one (1) base counterweight (A), eight (8) side counterweight (B) and two side counterweights (C)  
116,840 lbs (53,000 kg)  
two (2) carbody weight 22,050 lbs (10,000 kg)  
Additional weight consists of two (2) side counterweights (C) and two (2) carbody weights.

Description		Light	Standard
Base Counterweight (A)		1	1
Side Counterweight (B)		8	8
Side Counterweight (C)		0	2
Carbody Counterweight		0	2
Total Weight	Upper	105,820 lbs (48,000 kg)	116,840 lbs (53,000 kg)
	Lower	None	22,050 lbs (10,000 kg)

## 5.4 Gantry

This high folding type gantry is fitted with a sheave frame for boom hoist reeving. Hydraulic lift is standard. It provides full up, full down positions with linkage.

## 5.5 Operator's cab

Totally enclosed from weather, this full-vision cab has safety glass all around. The adjustable, high-backed seat with armrest is standard, allowing operators to customize the position. Auxiliary controls and instruments are on a side mounted console. A signal horn, windshield wipers, air conditioner are all standard features.

## 5.6 Controls

At operator's right are console-mounted adjustable short levers for the front and rear drum and the boom hoist control. Beside the operator's seat on the right are two short levers for propel control, individual speed shifts for front drum, rear drum and boom drum. At the operator's left are the console mounted swing lever, knobs for front and rear drum, boom drum pawls, engine start / stop key. A swing brake control switch and signal horn button are on the swing lever.

## 5.7 Electric system

All wiring corded for easy serving, individual fused branch circuit.

## 5.8 Hydraulic system

**Maximum pressure rating** 4,620 psi (31.9 Mpa)  
**Cooling** Oil to air heat exchanger  
**Filtration** Full flow filters with replaceable paper elements

## 5.9 Boom hoist

Powered by hydraulic motor through planetary reducer.

### Drum

Single drum.  
Grooved for 20.0 mm dia. wire rope.

### Brake

A spring set, hydraulically-released, multiple-disc holding brake is mounted inside the boom hoist motor and is operated through a counter-balance valve. An external ratchet is fitted for locking the drum.

## 5.10 Front drum

Powered by hydraulic motor through planetary reducer.

### Drum

26.2" (666 mm) P.C.D. X 26.5" (672 mm) Lg.  
Grooved for 26 mm dia. wire rope.

### Brake

A spring set, hydraulically-released, multiple-disc holding brake is mounted inside the hoist motor and is operated through a counter-balance valve. An external ratchet is fitted for locking the drum.

### Free-Fall (Optional)

Wet-type disk brake free-fall is mounted inside the drum.

## 5.11 Rear drum

Powered by hydraulic motor through planetary reducer.

### Drum

26.2" (666 mm) P.C.D. X 26.5" (672 mm) Lg.  
Grooved for 26 mm dia. wire rope.

## Brake

A spring set, hydraulically-released, multiple-disc holding brake is mounted inside the hoist motor and is operated through a counter-balance valve. An external ratchet is fitted for locking the drum.

## Free-Fall (Optional)

Wet-type disk brake free-fall is mounted inside the drum.

### 5.12 Third winch (Optional)

Powered by hydraulic motor through planetary reducer. Installed in base machine. Free-fall is not applied

#### Drum

24.2" (614 mm) P.C.D. X 24.3" (617 mm) Lg.  
Grooved for 26 mm dia. wire rope.

#### Brake

A spring set, hydraulically-released, multiple-disc holding brake is mounted inside the hoist motor and is operated through a counter-balance valve. An external ratchet is fitted for locking the drum.

### 5.13 Swing

#### Swing unit

Hydraulic motor driving through planetary reducer to output swing pinion for 360 degree rotation.

#### Swing brake

Spring set hydraulically released multiple disk brake mounted on swing motor.

#### Swing circle

Single row ball bearing with internal, integral swing gear.

**Swing Lock** 4 Position lock for transportation.

## 6. LOWER MACHINERY

### 6.1 Carbody

The durable carbody features steel welded construction with axles.

### 6.2 Crawler

Crawler assemblies are designed with quick disconnect feature for individual removal as a unit from axles. Crawler belt tension adjusted with hydraulic jack and maintained by shims between the idler block and frame.

### 6.3 Crawler drive

The independent hydraulic propel drive is built into each crawler side frame. Each drive consists of a hydraulic motor driving a propel sprocket through a planetary gear box. The hydraulic motor and gearbox are built into the crawler side frame within the shoe width.

### 6.4 Crawler brakes

Spring set, hydraulically released, multiple disk-type parking brakes are built into each propel drive.

### 6.5 Steering mechanism

The hydraulic propel system provides both skid steering (driving one track only) and counter-rotating steering (driving each track in opposite direction).

### 6.6 Crawler shoes

60 shoes, 48" (1,220 mm) wide each crawler.

### 6.7 Track rollers

The track rollers are sealed for maintenance-free operation.

## 7. CRANE ATTACHMENTS

### 7.1 Crane boom

The welded lattice construction uses tubular, high-tension steel chords with pin connections between sections.

**Maximum boom length** 250' (76.2 m)

**Basic boom length** 50' (15.2 m)

**Boom base section** 25' (7.6 m)

**Boom tip section (with Taper insert boom)**  
25' (7.6 m)

### 7.2 Boom insert (Optional)

An optional boom inserts is available to provide extension capabilities. It also has welded lattice construction with tubular, high-tension steel chords and pin connections on each one of 10' (3.1 m), 20' (6.1 m), 40' (12.2 m) in length.

### 7.3 Jib (Optional)

The optional jib employs welded lattice construction with tubular, high-tension steel chords with pin connections between sections.

**Maximum jib length** 100' (30.5 m)

**Basic jib length** 40' (12.2 m)

**Jib base section** 15' (4.6 m)

**Jib tip section** 15' (4.6 m)

**Jib insert** 10' (3.1 m), 20' (6.1 m)

Jib inserts are available to provide extension capabilities. They also have welded lattice construction with tubular, high-tension steel chords and pin connections.

Jib is extendible on booms of 90' (27.4 m) through 200' (61.0 m)

#### 7.4 Auxiliary sheave (Optional)

Auxiliary sheave is extendible on booms of 50' (12.2 m) to 240' (73.2 m).

Maximum line: 2 parts of 26 mm wire rope

#### 7.5 Diameter of wire rope

Hoist rope	26 mm
Boom hoist rope	20 mm
Boom pendant rope	30 mm
Jib pendant rope	26 mm

#### 7.6 Boom hoist reeving

Twelve (12) parts of 20 mm dia. high strength wire rope.

#### 7.7 Boom backstops

Telescopic type with spring bumper.

Swing alarm (Buzzer and lamps)  
Hook over hoist shut off (Anti-two-block)  
Boom angle indicator  
Boom hoist drum lock  
Swing lock  
Boom backstops

### 8. AUXILIARY EQUIPMENT

#### 8.1 Lights

Two (2) front flood lights  
One (1) cab inside light

#### 8.2 Gauges and warning display

##### Gauges

One (1) Tachometer  
One (1) Hour meter  
One (1) Fuel gauge  
One (1) Water temperature gauge for engine

##### Warning display

Battery charge  
Engine oil pressure  
Air cleaner  
Engine oil filter  
Control main pressure  
Hydraulic oil temperature

#### 8.3 Others

Air conditioner  
Drum turn indicator (front and rear drum)  
Foot acceleration pedal  
Electric fuel pump  
Counterweight self-removal device

### 9. SAFETY SERVICE

Over load preventive device (Load Moment Indicator)  
Function lock lever  
Boom over hoist limit switch  
Signal horn  
Front and rear hoist drum lock

### 10. TOOLS AND ACCESSORIES

A set of tools and accessories are furnished.

### 11. OPTIONAL EQUIPMENT

Front and rear winch free-fall (Wet-type disc brake)  
Third drum  
Reeving winch  
Hydraulic boom foot pin cylinder  
Hydraulic tagline  
Pillow plate for boom self-erection  
Custom color

All specifications are subject to change without notice.

# CK1600-II Winch Performance Data **KOBELCO**

## Front and Rear drum

Wire rope diameter: 26 mm

Rated line pull: 29,500 lbs (13,380 kg)

Maximum pull: 50,250 lbs (22,800 kg)

Total storage capacity: 1,383 ft (422 m)

		Line Speed (ft/min)							
		Layer	1	2	3	4	5	6	7
Line Pull (lbs)	0		393	419	445	471	497	523	
	5,000		386	412	437	462	487	512	
	10,000		353	353	353	353	353	353	
	15,000		235	235	235	235	235	235	
	20,000		177	177	177	177	177	177	storage only
	29,500		120	120	120	120	120	120	
	35,000		101	101	101	101	101	101	
	40,000		90	90	90	90			
	50,250		73						
Storage Capacity (ft)			165	176	187	198	208	219	230

## Third drum (optional)

Wire rope diameter: 26 mm

Rated line pull: 29,500 lbs (13,380 kg)

Maximum pull: 54,510 lbs (24,730 kg)

Total storage capacity: 795 ft (243 m)

		Line Speed (ft/min)					
		Layer	1	2	3	4	5
Line Pull (lbs)	0		328	355	379	403	427
	5,000		326	349	372	395	418
	10,000		241	234	231	231	231
	15,000		154	154	154	154	154
	20,000		115	115	115	115	115
	29,500		78	78	78	78	78
	40,000		58	57	57	57	57
	50,000		46	46			
	54,510		43				
Storage Capacity (ft)			139	149	159	169	179

## Wire Rope Specifications

Use	Construction	No load diameter	Length	Safety Factor	Required minimum breaking strength
Front drum	UNI rope (U3 x SeS48) Regular lay, Right hand lay	1.050" to 1.069" (26.65 mm to 27.17 mm)	902' (275 m)	3.5: 1	103,250 lbs (46,840 kg)
Rear drum	UNI rope (U3 x SeS48) Regular lay, Right hand lay	1.050" to 1.069" (26.65 mm to 27.17 mm)	836' (255 m)	3.5: 1	103,250 lbs (46,840 kg)
Boom Drum	6 x 31 Warrington seal Right hand lay, Regular lay	0.807" to 0.822" (20.50 mm to 20.90 mm)	623' (190 m)	3.5: 1	73,640 lbs (33,400 kg)
Third drum (Optional)	6 x 25 Filler IWRC Right hand lay, Regular lay	1.050" to 1.069" (26.65 mm to 27.17 mm)	787' (240 m)	3.5: 1	103,250 lbs (46,840 kg)

# CK1600-II General Dimensions

# KOBELCO

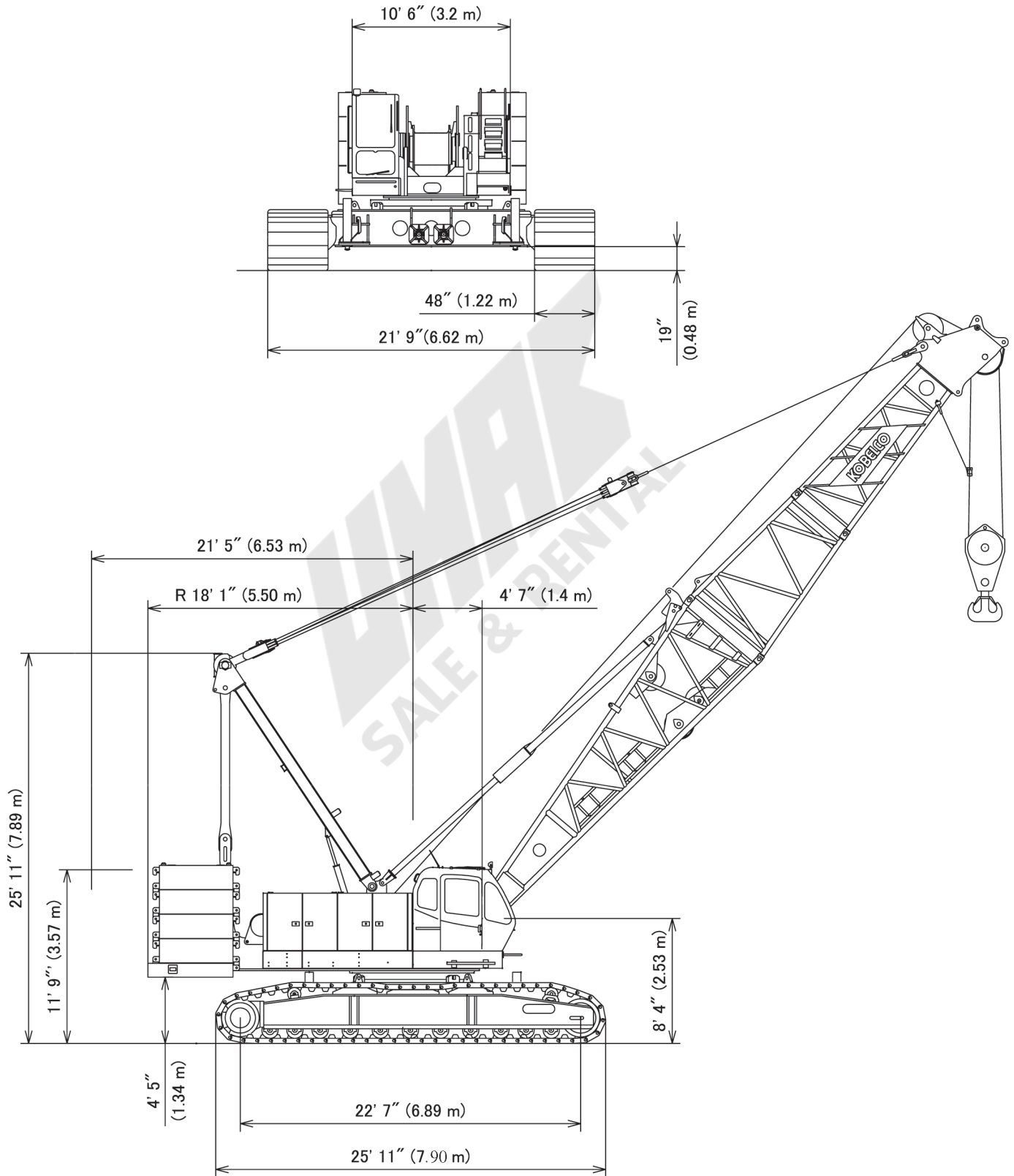



# CK1600-II Dimension and Weight



## Base Machine-1

Boom base with self-assembly sheave, Counterweight Self-Removal Cylinder, Translifter and Front, Rear, Boom hoist wire rope  
 Weight: 86,420 lbs (39,200 kg)

## Base Machine-2

In addition Base Machine-1, optional Front/Rear Free-Fall Break equipped.  
 Weight: 88,180 lbs (40,000 kg)

## Base Machine-3

In addition Base Machine-2, optional Third drum and wire rope equipped.  
 Weight: 92,480 lbs (41,950 kg)

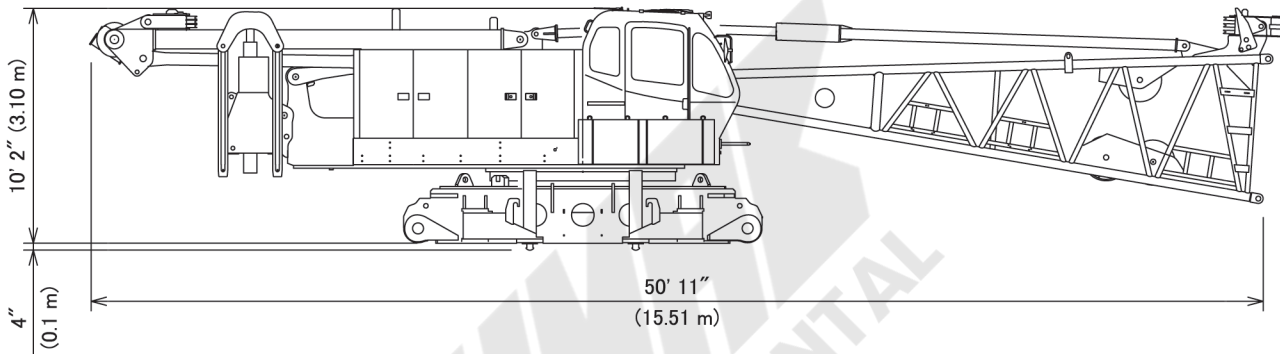
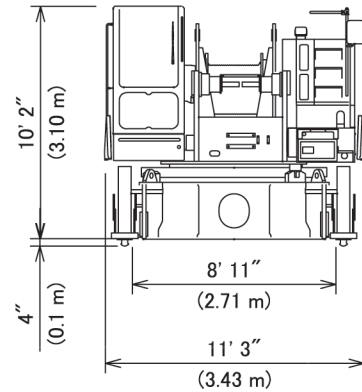

## Crawler

Weight: 36,155 lbs (16,400 kg)

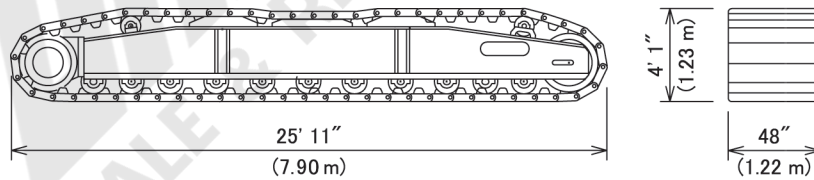

## Counterweight (A)

Weight: 17,640 lbs (8,000 kg)

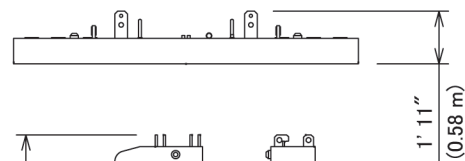
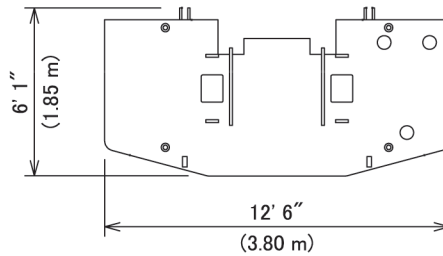

## Counterweight (B)

Weight: 11,025 lbs (5,000 kg)

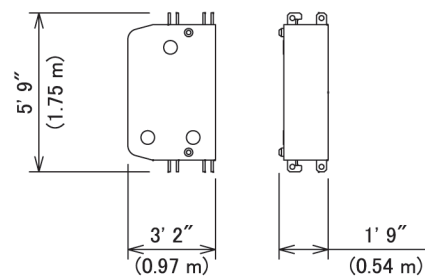

# CK1600-II Dimension and Weight



## Counterweight (C) (optional)

Weight: 5,513 lbs (2,500 kg)

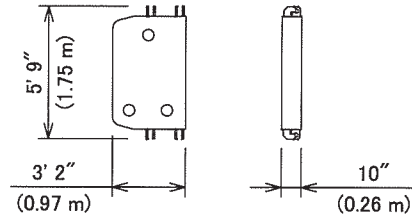

## Carbody Weight (optional)

Weight: 11,025 lbs (5,000 kg)

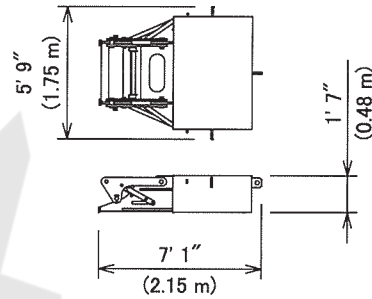

## Counterweight Self-Removal Cylinder

Weight: 3,704 lbs (1,680 kg)

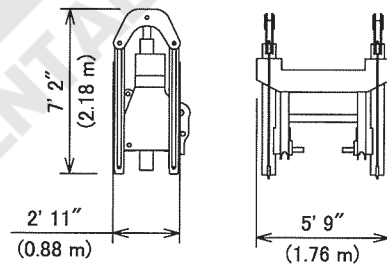

## Boom Tip

Weight: 4,100 lbs (1,860 kg)  
includes guy lines.

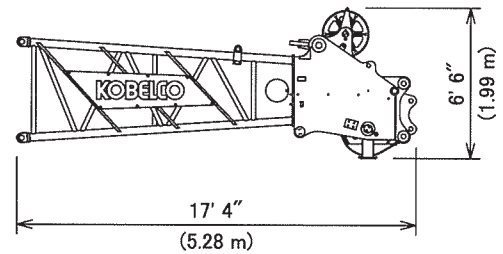
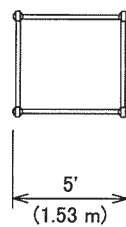

## Taper Insert Boom

Weight: 1,190 lbs (540 kg)  
includes cable roller.

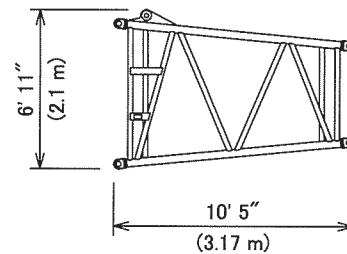
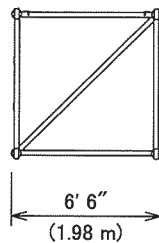

# CK1600-II Dimension and Weight



## 10 ft Insert Boom

Weight: 1,390 lbs (630 kg)  
Includes cable roller and guy lines.

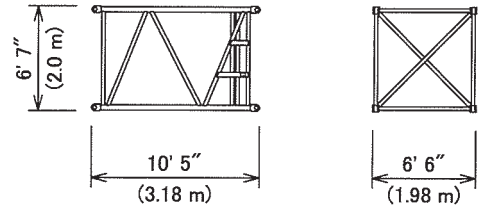

## 20 ft Insert Boom

Weight: 2,200 lbs (1,000 kg)  
Includes cable roller and guy lines.

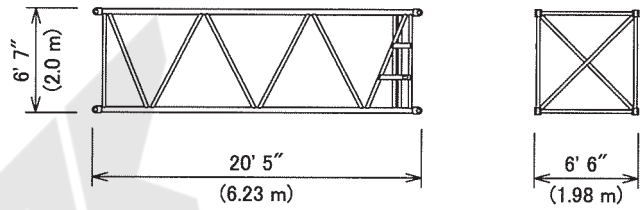

## 40 ft Insert Boom

Weight: 3,770 lbs (1,710 kg)  
Includes cable roller and guy lines.

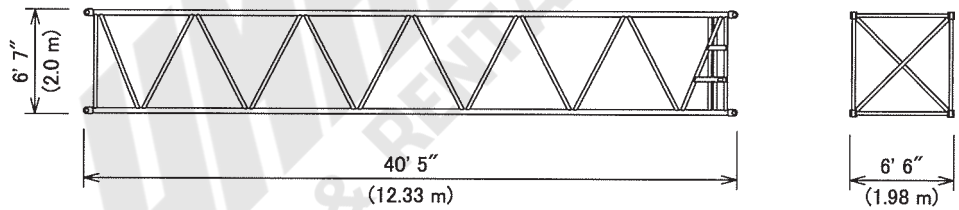

## Boom Base with Backstop

Weight: 8,110 lbs (3,680 kg)

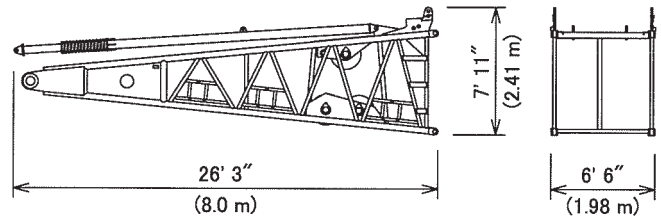

## Auxiliary Sheave

Weight: 650 lbs (290 kg)

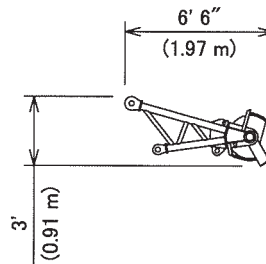

# CK1600-II Dimension and Weight



## Jib Base with Strut

Weight: 2,270 lbs (1,030 kg)  
Includes guy lines.

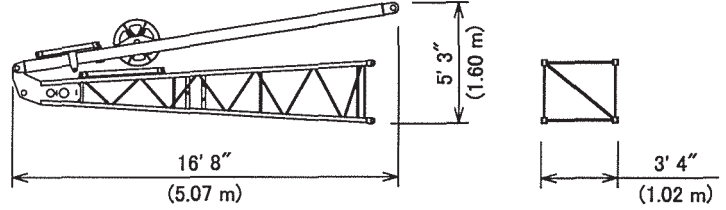

## Jib Tip

Weight: 690 lbs (310 kg)  
Includes cable roller

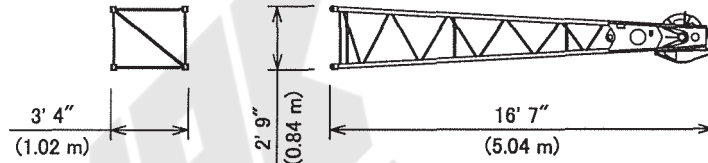

## 10 ft Insert Jib

Weight: 270 lbs (120 kg)  
Includes cable roller

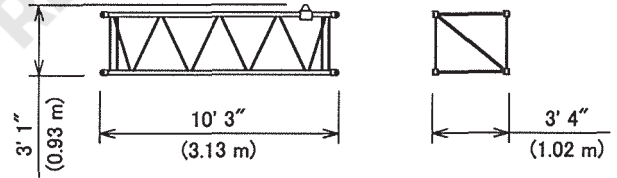

## 20 ft Insert Jib

Weight: 520 lbs (240 kg)  
Includes cable roller and guy lines

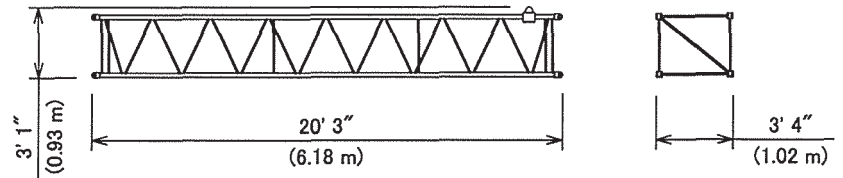

# CK1600-II Dimension and Weight



## Translifter

Weight: 820 lbs (370 kg)

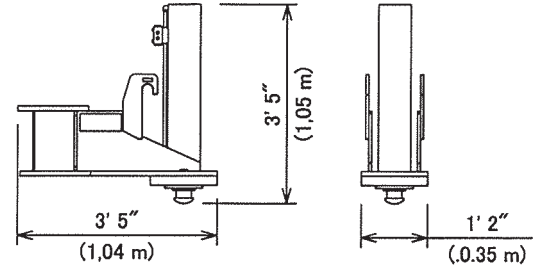

## Gantry with Lower Spreader

Weight: 5,560 lbs (2,520 kg)

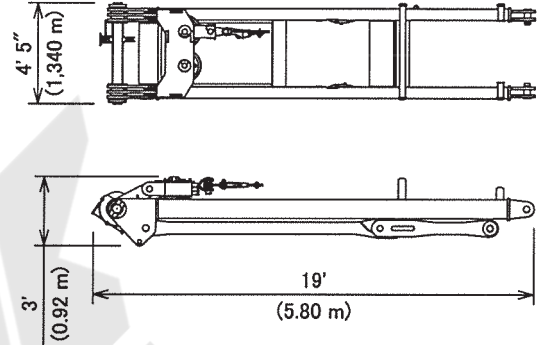

## Upper Spreader

Weight: 1,070 lbs (485 kg)

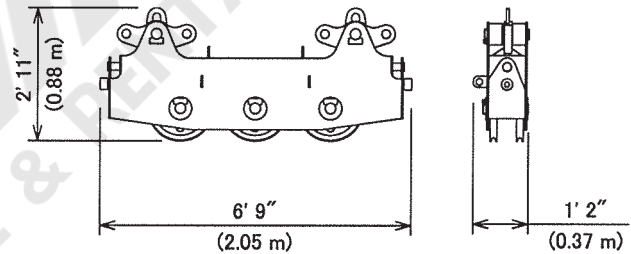

## Lower Spreader

Weight: 700 lbs (320 kg)

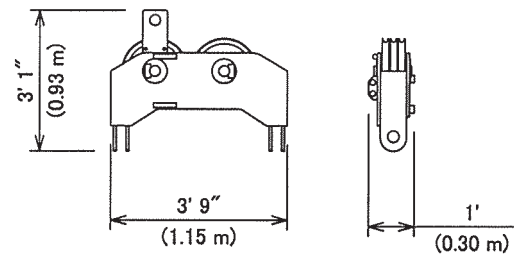

## Boom Backstop

Weight: 1,140 lbs (515 kg)

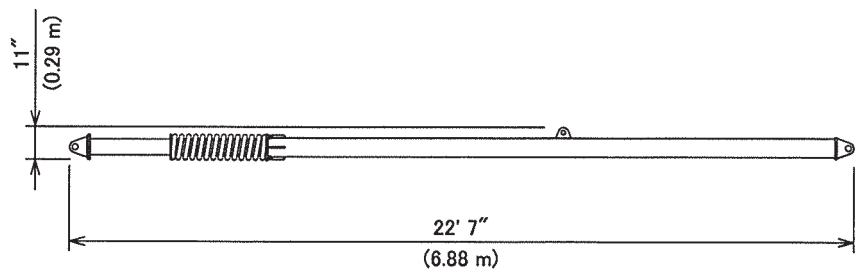

# CK1600-II Transportation Plan



250 ft boom and 100 ft jib

Description of item	Weight lbs (kg)	Trailer Loads						
		#1	#2	#3	#4	#5	#6	#7
Base Machine with Boom Base	86,420 (39,200)	1						
Crawler	36,155 (16,400)		1	1				
Counterweight (A)	17,640 (8,000)					1		
Counterweight (B)	11,025 (5,000)				3	2	3	
Counterweight (C)	5,513 (2,500)							2
Carbody Weight	11,025 (5,000)							2
10 ft Insert Boom and Guy Line	1,390 (630)				1	1		
20 ft Inset Boom and Guy Line	2,200 (1,000)						1	
40 ft Insert Boom and Guy Line	3,770 (1,710)		1	1	1	1		
Taper Insert Boom	1,190 (540)						1	
Boom Tip and Guy Line	4,100 (1,860)						1	
Jib Base and Guy Line	2,270 (1,030)							1
10 ft Inset Jib	270 (120)							1
20 ft Inset Jib and Guy Line	520 (240)							3
Jib Tip	690 (310)							1
Approx. Total Shipping Weight	lbs (kg)	86,420 (39,200)	39,925 (18,110)	39,925 (18,110)	38,235 (17,340)	44,850 (20,340)	40,565 (18,400)	37,866 (17,180)

Target of payload: 45,000 lbs weight, 48 ft long, 8 ft 6 inch width and 13 ft 6 inch height from ground  
Above plan may vary by each state law or specification of trailers.

**Trailer #1**

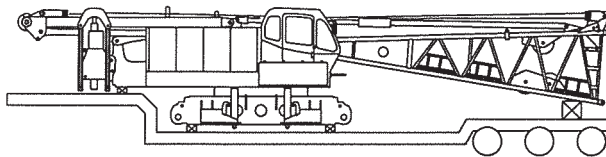

**Trailer #2**

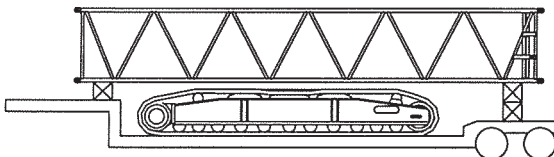

**Trailer #3**

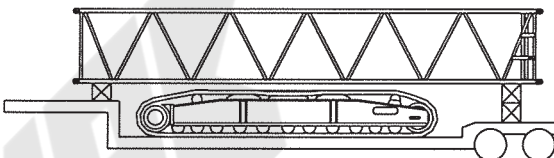

**Trailer #4**

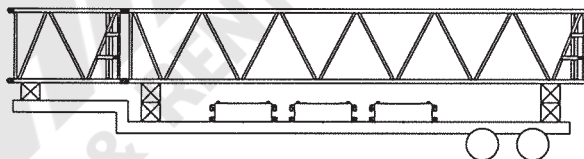

**Trailer #5**

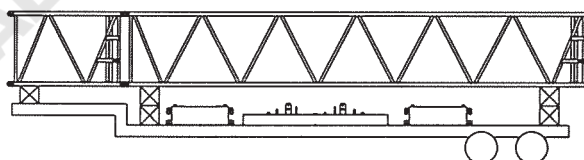

**Trailer #6**

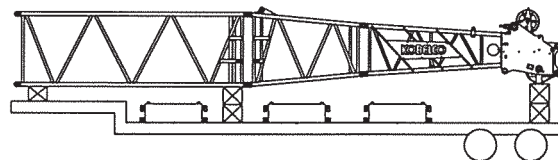

**Trailer #7**

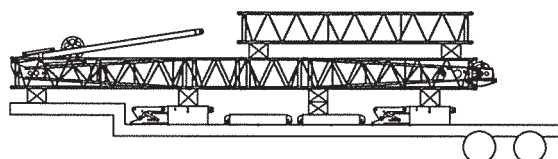

# CK1600-II Self Assembly Procedure **KOBELCO**

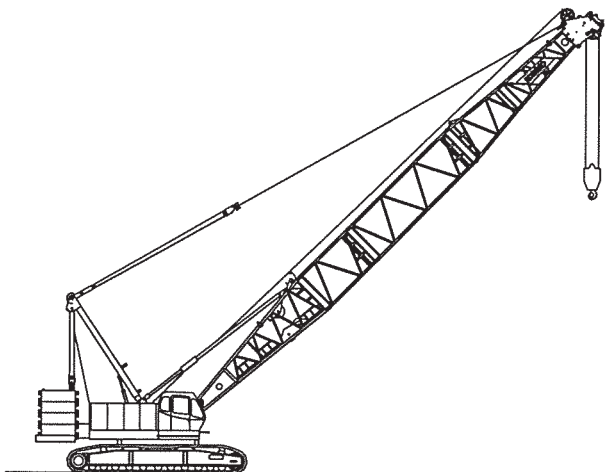
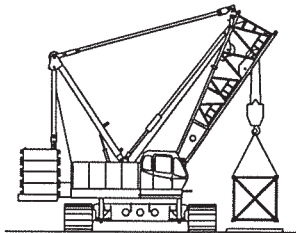
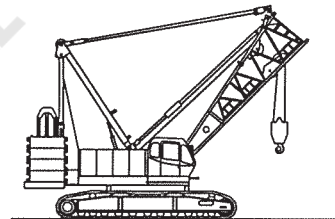
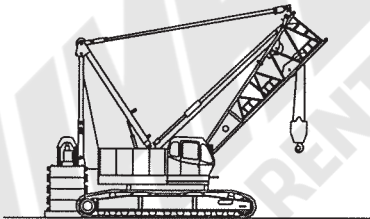
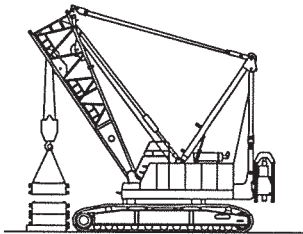
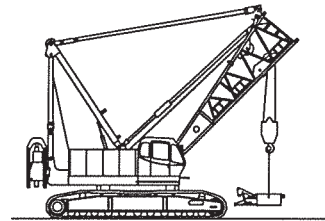
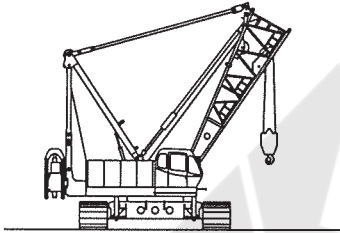
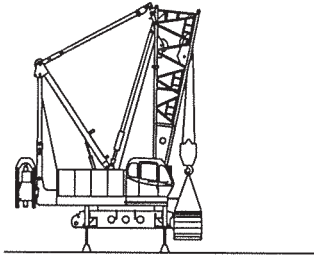
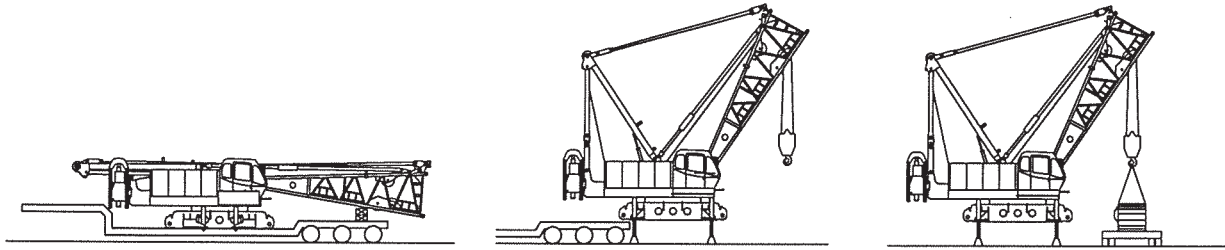



## Boom Arrangement

Boom	Insert Boom			Aux. Sheave	Fixed Jib
	10 ft	20 ft	40 ft		
50 ft				Y1	
60 ft	1			Y1	
70 ft		1		Y1	
80 ft	1	1		Y1	
90 ft	2	1		Y1	Y2
100 ft	1	2		Y1	Y2
110 ft	2	2		Y1	Y2
120 ft	1	1	1	Y1	Y2
130 ft	2	1	1	Y1	Y2
140 ft	1	2	1	Y1	Y2
150 ft	2	2	1	Y1	Y2
160 ft	1	1	2	Y1	Y2
170 ft	2	1	2	Y1	Y2
180 ft	1	2	2	Y1	Y2
190 ft	2	2	2	Y1	Y2
200 ft	1	1	3	Y1	Y2
210 ft	2	1	3	Y1	
220 ft	1	2	3	Y1	
230 ft	2	2	3	Y1	
240 ft	1	1	4	Y1	
250 ft	2	1	4		

## Jib Arrangement

Jib	Insert Jib	
	10 ft	20 ft
40 ft	1	
60 ft	1	1
80 ft	1	2
100 ft	1	3

Y1: Auxiliary sheave can be attached.  
Y2: Fixed jib can be attached.

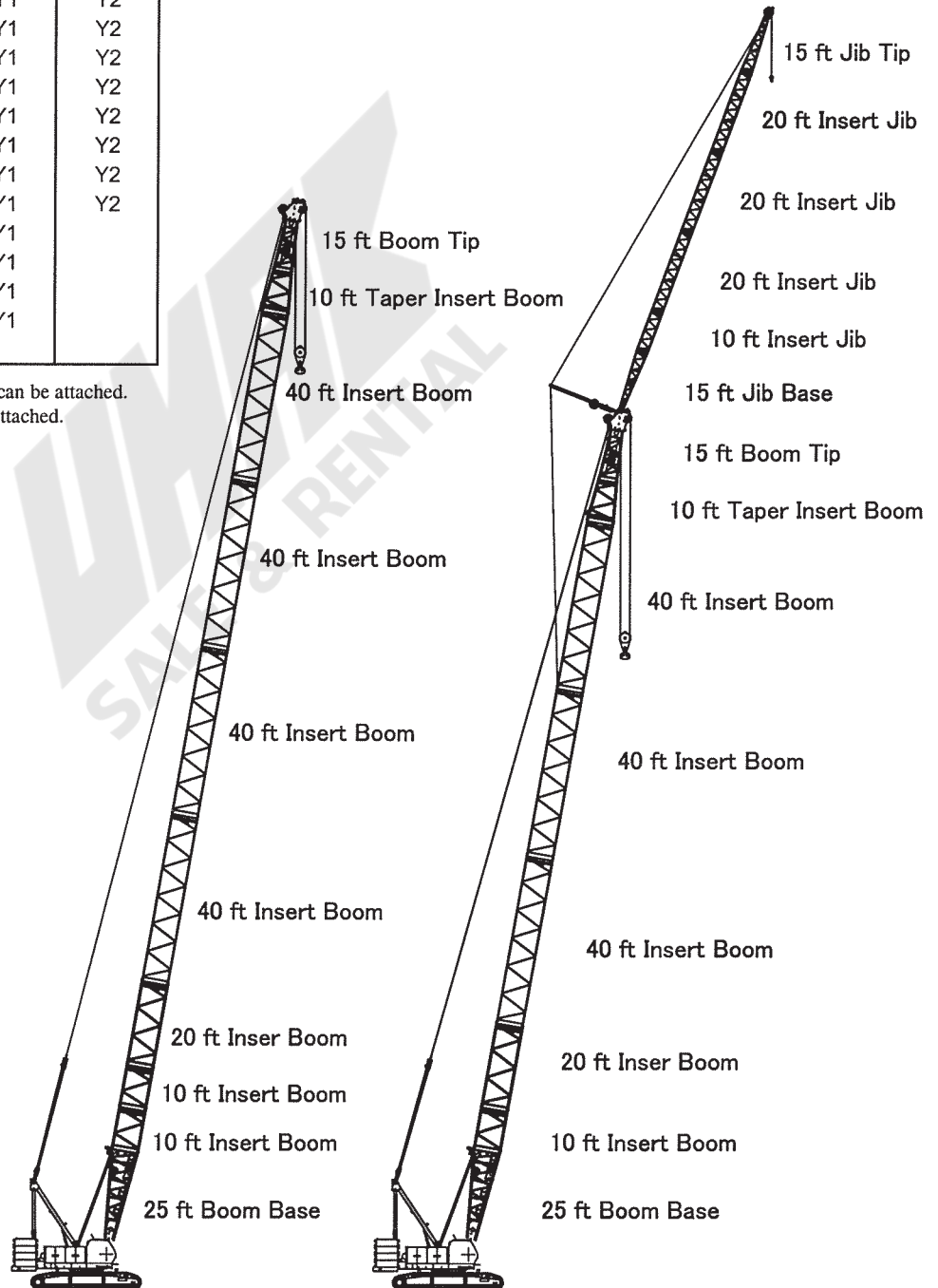

250 ft (76.2 m) Main Boom

200 ft (60.1 m) Main Boom and 100 ft (30.5 m) Jib

# CK1600-II Main Boom Working Range

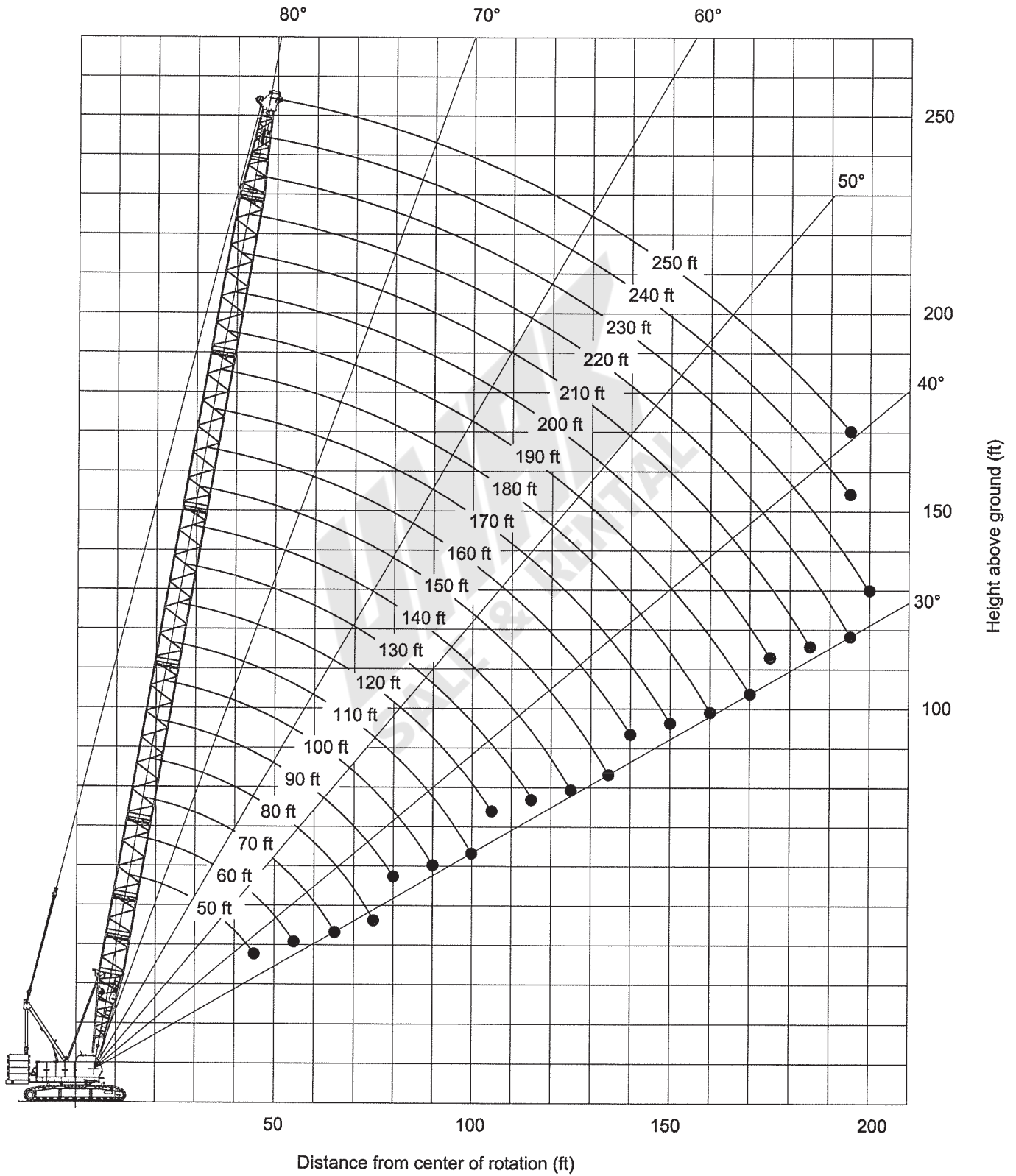

# CK1600-II Jib Working Range

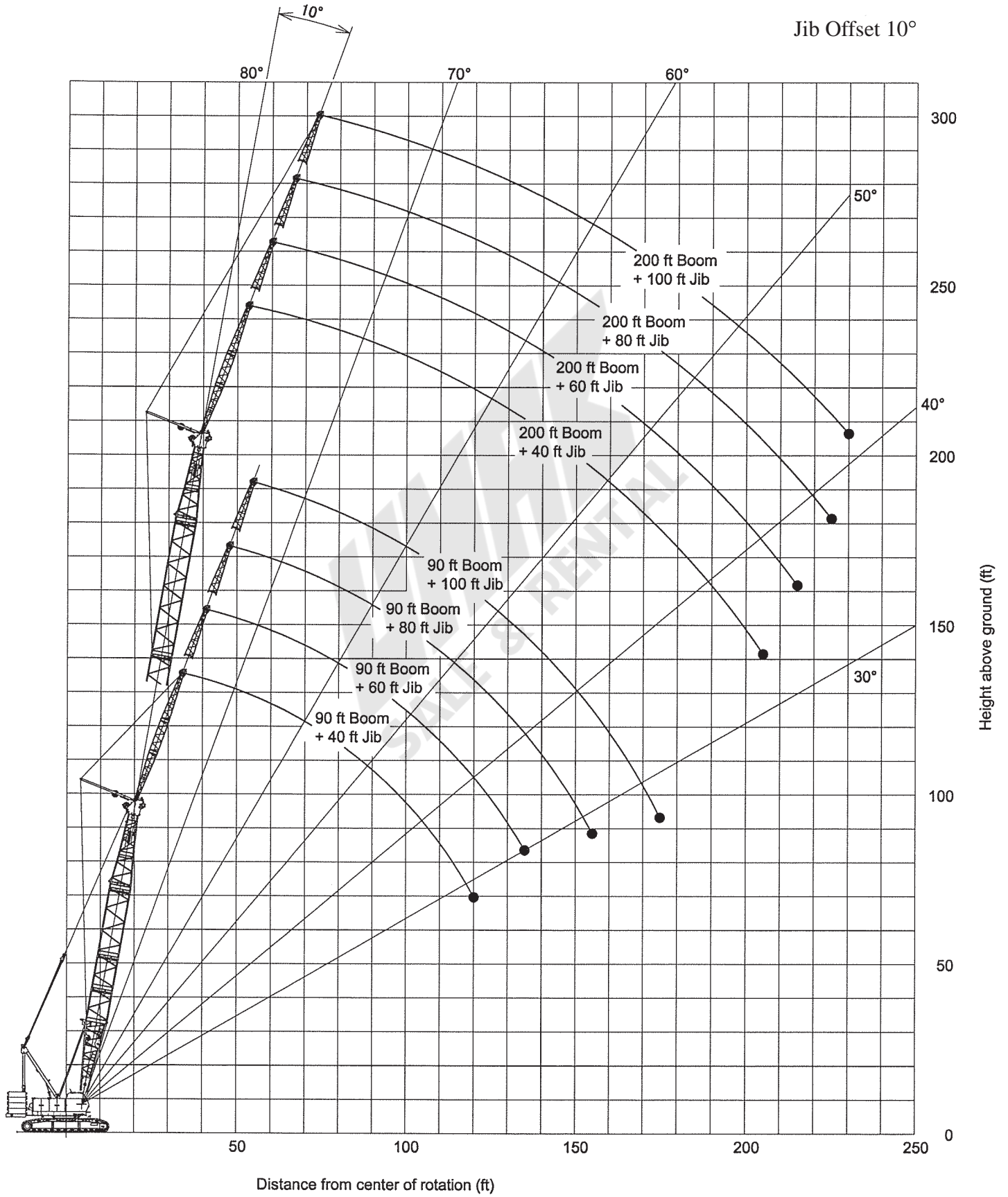

# CK1600-II Jib Working Range



Jib Offset 30°

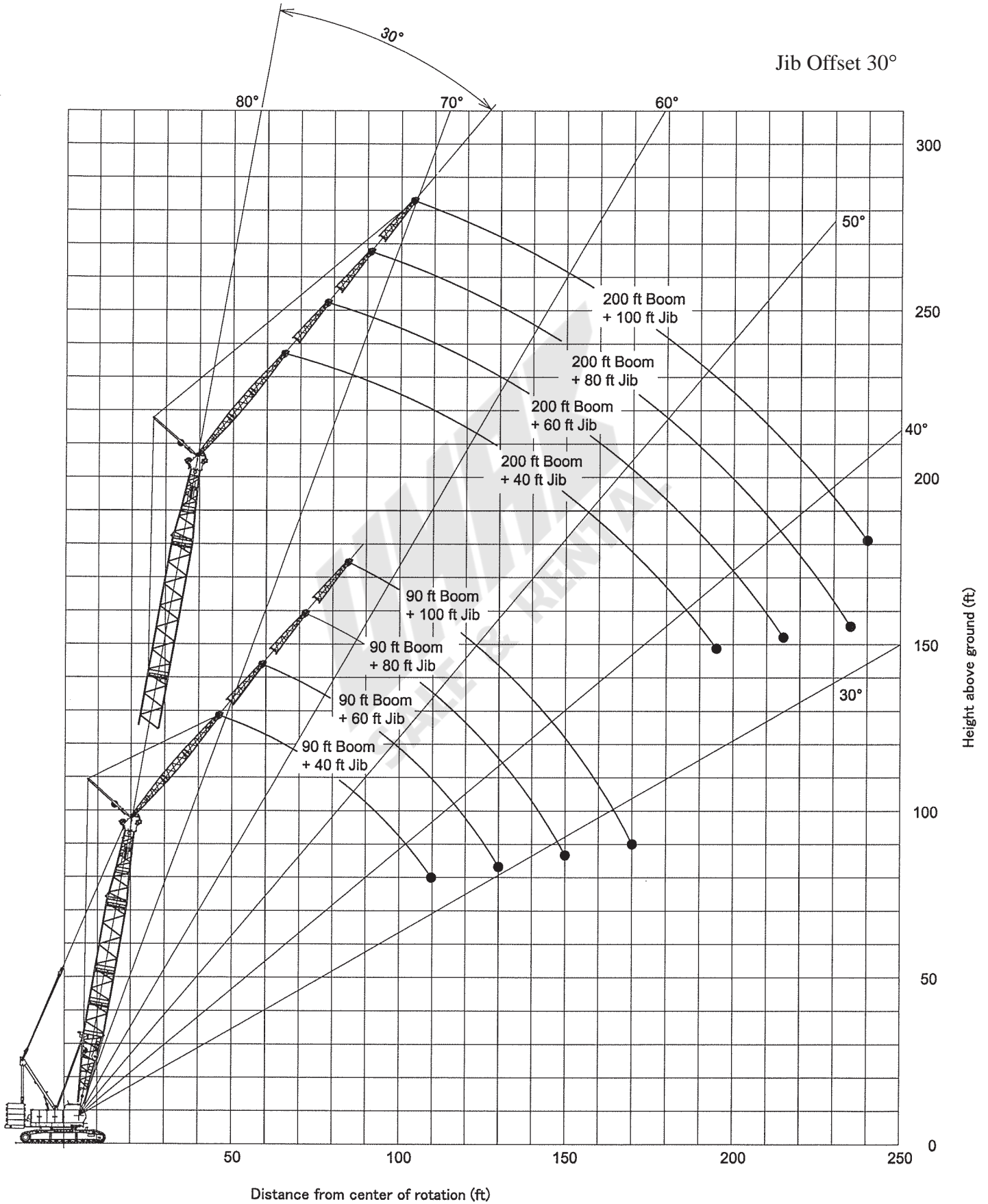

# KOBELCO CK1600-II Main boom rated loads in pounds

Counterweight: 116,840 lbs (53,000 kg)

Carbody weight: 22,050 lbs (10,000 kg)

## Supplemental Data

- Rated loads included in the charts are the maximum allowable freely suspended loads at a given boom length, boom angle and load radius, and have been determined for the machine standing level on firm supporting surface under ideal operating conditions. The user must limit or de-rate rated loads to allow for adverse conditions (such as soft or uneven ground, out-of-level conditions, wind, side loads, pendulum action, jerking or sudden stopping of loads, inexperience of personnel, multiple machine lifts, and traveling with a load).
- Rated loads do not exceed 75% of minimum tipping loads. Rated loads based on factors other than machine stability such as structural competence are shown by asterisk \* in the charts.
- The machine must be reeved and set-up as stated in the operation manual and all the instruction manuals if these manuals are missing, obtain replacements.

- The crane must be leveled to within 1% on a firm supporting surface.
- Boom backstops are required for all boom length.
- Gantry must be fully raised position for all operations.

- Do not attempt to lift where no radius on load is listed as crane may tip or collapse.
- Attempting to lift more than rated loads may cause machine to tip or collapse. Do not tip machine to determine rated loads.
- Weight of hooks, hook blocks, slings and other lifting devices are a part of the total load. Their total weight must be subtracted from the rated load to obtain the weight that can be lifted.
- When lifting over boom point with jib or auxiliary sheave, rated loads for the boom must be deducted as shown below.

Jib Length (ft)	Aux	40	60	80	100
Deductions (lbs)	1,250	7,055	8,010	8,965	9,920

- The total load that can be lifted by jib is limited by rated jib loads.
- Boom lengths for jib mounting are 90 ft (27.4 m) to 200 ft (61.0 m)
- 40 ft (12.2m) jib length with offset angle of 10 degrees, and one part of line on the hook is not allowed.

- The total load that can be lifted by the auxiliary sheave is: the rated load for the boom (without auxiliary sheave installed) minus 1,250 lbs; however, the auxiliary sheave rated load should not exceed 59,000 lbs.
- Boom lengths that can attach auxiliary sheave are from 50 ft (15.2 m) to 240 ft (73.2 m).
- The boom should be erected over the front of the crawlers, not laterally. When lifting from or lowering to the ground the boom at length of 240 ft (73.2 m) or over, the blocks must be placed at the end of crawlers.
- Least stable position is over the side.
- Maximum hoist load for number of reeving parts of line for hoist rope.

### Main Load for Main Boom

No. of Parts of line	1	2	3	4	5
Maximum Loads (lbs)	29,500	59,000	88,500	118,000	147,500

No. of Parts of line	6	7	8	9	10
Maximum Loads (lbs)	177,000	206,500	236,000	265,500	295,000

No. of Parts of line	11
Maximum Loads (lbs)	320,000

### Main Load For Jib Hoist

No. of Parts of line	1	2
Maximum Loads (lbs)	29,500	59,000

### Main Load for Auxiliary Sheave

No. of Parts of line	1	2
Maximum Loads (lbs)	29,500	59,000

- Weight of the recommended hook block.

Hook Block	160 Ust	110 Ust	70 Ust	30 Ust	15 Ust ball hook
Weight (lbs)	5,275	3,960	2,775	2,200	1,315

- Rated loads listed apply only to the machine as originally manufactured and designed by KOBELCO CRANES CO., LTD. Modifications to this machine or use of equipment other than that specified can reduce operating capacity.
- Designed and rated to comply with ANSI Code B30.5.

Operation of this equipment in excess of rated loads or disregard of instruction voids the warranty

## CK1600-II Main Boom Rated Loads

with 11 counterweights (116,840 lbs) and 2 carbody weights (22,050 lbs)

Refer to notes page 19

50' Boom			60' Boom			70' Boom			80' Boom		
Load Radius (ft)	Boom Angle (deg.)	360° Rated Load (lbs)	Load Radius (ft)	Boom Angle (deg.)	360° Rated Load (lbs)	Load Radius (ft)	Boom Angle (deg.)	360° Rated Load (lbs)	Load Radius (ft)	Boom Angle (deg.)	360° Rated Load (lbs)
15.0	79.9	320,000 *	17.0	79.6	280,000 *	19.0	79.5	251,100 *	22.0	78.6	211,800 *
16.0	78.7	300,100 *	18.0	78.7	266,000 *	20.0	78.6	238,500 *	24.0	77.1	190,200 *
17.0	77.5	282,500 *	19.0	77.7	251,900 *	22.0	76.9	217,100 *	26.0	75.7	172,600 *
18.0	76.3	266,800 *	20.0	76.7	239,300 *	24.0	75.3	194,600 *	28.0	74.2	157,800 *
19.0	75.1	252,700 *	22.0	74.7	218,000 *	26.0	73.5	176,300 *	30.0	72.7	145,500 *
20.0	73.9	240,100 *	24.0	72.7	197,500 *	28.0	71.8	160,900 *	32.0	71.1	134,400 *
22.0	71.5	218,300 *	26.0	70.7	178,300 *	30.0	70.1	147,900 *	34.0	69.6	123,000 *
24.0	69.1	197,700 *	28.0	68.6	162,200 *	32.0	68.3	134,700 *	36.0	68.1	113,300 *
26.0	66.5	177,400 *	30.0	66.5	148,300 *	34.0	66.5	123,400 *	38.0	66.5	105,100 *
28.0	64.0	160,400 *	32.0	64.4	134,900 *	36.0	64.7	113,700 *	40.0	64.9	97,800 *
30.0	61.4	145,900 *	34.0	62.2	123,600 *	38.0	62.8	105,500 *	45.0	60.8	83,300 *
32.0	58.7	133,300 *	36.0	60.0	113,900 *	40.0	61.0	98,300 *	50.0	56.6	72,300 *
34.0	55.9	122,100 *	38.0	57.7	105,800 *	45.0	56.1	83,700 *	55.0	52.1	63,900 *
36.0	53.0	112,200 *	40.0	55.4	98,500 *	50.0	50.9	72,700 *	60.0	47.4	56,800 *
38.0	50.0	103,300 *	45.0	49.3	83,900 *	55.0	45.3	64,300 *	65.0	42.2	51,300 *
40.0	46.8	95,200 *	50.0	42.4	72,000 *	60.0	39.0	57,300 *	70.0	36.3	46,700 *
45.0	38.0	76,900 *	55.0	34.4	60,100 *	65.0	31.7	48,700 *	75.0	29.5	40,300 *
90' Boom			100' Boom			110' Boom			120' Boom		
Load Radius (ft)	Boom Angle (deg.)	360° Rated Load (lbs)	Load Radius (ft)	Boom Angle (deg.)	360° Rated Load (lbs)	Load Radius (ft)	Boom Angle (deg.)	360° Rated Load (lbs)	Load Radius (ft)	Boom Angle (deg.)	360° Rated Load (lbs)
22.0	79.9	207,600 *	24.0	79.8	183,400 *	26.0	79.6	164,200 *	28.0	79.5	147,000 *
24.0	78.6	186,500 *	26.0	78.6	166,400 *	28.0	78.6	150,100 *	30.0	78.6	135,500 *
26.0	77.3	169,000 *	28.0	77.4	152,300 *	30.0	77.5	138,200 *	32.0	77.6	125,600 *
28.0	76.0	154,700 *	30.0	76.2	140,400 *	32.0	76.4	128,300 *	34.0	76.6	117,000 *
30.0	74.6	142,600 *	32.0	75.0	130,200 *	34.0	75.4	119,400 *	36.0	75.6	109,500 *
32.0	73.3	132,200 *	34.0	73.8	121,400 *	36.0	74.3	111,900 *	38.0	74.6	102,900 *
34.0	72.0	122,700 *	36.0	72.6	112,800 *	38.0	73.2	104,400 *	40.0	73.6	96,700 *
36.0	70.6	113,000 *	38.0	71.4	104,700 *	40.0	72.1	97,200 *	45.0	71.1	82,200 *
38.0	69.3	104,700 *	40.0	70.2	97,400 *	45.0	69.3	82,600 *	50.0	68.6	71,200 *
40.0	67.9	97,400 *	45.0	67.1	82,800 *	50.0	66.5	71,600 *	55.0	65.9	62,600 *
45.0	64.4	82,800 *	50.0	63.9	71,800 *	55.0	63.6	63,000 *	60.0	63.3	55,500 *
50.0	60.8	72,000 *	55.0	60.7	63,200 *	60.0	60.6	56,200 *	65.0	60.6	50,000 *
55.0	57.0	63,400 *	60.0	57.3	56,400 *	65.0	57.5	50,400 *	70.0	57.8	45,100 *
60.0	53.1	56,400 *	65.0	53.8	50,700 *	70.0	54.4	45,600 *	75.0	54.9	41,200 *
65.0	48.9	50,900 *	70.0	50.1	46,000 *	75.0	51.1	41,600 *	80.0	51.9	37,600 *
70.0	44.4	46,200 *	75.0	46.2	41,800 *	80.0	47.6	38,300 *	85.0	48.7	34,800 *
75.0	39.6	42,300 *	80.0	42.0	38,500 *	85.0	43.9	35,200 *	90.0	45.4	32,100 *
80.0	34.1	38,800 *	85.0	37.4	35,700 *	90.0	39.9	32,800 *	95.0	41.9	29,900 *
			90.0	32.3	32,800 *	95.0	35.6	30,400 *	100.0	38.1	27,900 *
						100.0	30.7	27,900 *	105.0	34.0	26,000 *

# CK1600-II Main Boom Rated Loads

with 11 counterweights (116,840 lbs) and 2 carbody weights (22,050 lbs)

Refer to notes page 19

130' Boom			140' Boom			150' Boom			160' Boom		
Load Radius (ft)	Boom Angle (deg.)	360° Rated Load (lbs)	Load Radius (ft)	Boom Angle (deg.)	360° Rated Load (lbs)	Load Radius (ft)	Boom Angle (deg.)	360° Rated Load (lbs)	Load Radius (ft)	Boom Angle (deg.)	360° Rated Load (lbs)
30.0	79.5	134,000 *	32.0	79.4	122,100 *	34.0	79.3	112,600 *	34.0	80.0	110,800 *
32.0	78.6	124,100 *	34.0	78.5	113,500 *	36.0	78.5	105,100 *	36.0	79.3	103,600 *
34.0	77.7	115,500 *	36.0	77.7	106,200 *	38.0	77.8	98,700 *	38.0	78.5	97,000 *
36.0	76.7	108,200 *	38.0	76.9	99,800 *	40.0	77.0	93,000 *	40.0	77.8	91,200 *
38.0	75.8	101,600 *	40.0	76.0	94,100 *	45.0	75.0	81,100 *	45.0	76.0	79,500 *
40.0	74.9	95,600 *	45.0	73.9	81,700	50.0	73.0	70,500	50.0	74.1	70,100
45.0	72.6	82,000	50.0	71.7	70,700	55.0	71.0	61,900	55.0	72.2	61,500
50.0	70.3	70,900	55.0	69.6	62,100	60.0	69.0	54,800	60.0	70.3	54,600
55.0	67.9	62,300	60.0	67.4	55,100	65.0	66.9	49,100	65.0	68.4	48,900
60.0	65.5	55,500	65.0	65.1	49,300	70.0	64.8	44,500	70.0	66.5	44,000
65.0	63.0	49,800	70.0	62.8	44,700	75.0	62.6	40,300	75.0	64.5	40,100
70.0	60.5	44,900	75.0	60.5	40,700	80.0	60.4	37,000	80.0	62.5	36,500
75.0	57.9	41,000	80.0	58.1	37,200	85.0	58.2	33,900	85.0	60.4	33,500
80.0	55.3	37,400	85.0	55.6	34,100	90.0	55.9	31,300	90.0	58.3	30,800
85.0	52.5	34,600	90.0	53.1	31,700	95.0	53.6	29,100	95.0	56.2	28,600
90.0	49.7	31,900	95.0	50.5	29,300	100.0	51.1	26,800	100.0	54.0	26,600
95.0	46.7	29,700	100.0	47.7	27,300	105.0	48.6	25,100	105.0	51.7	24,600
100.0	43.5	27,500	105.0	44.9	25,300	110.0	46.0	23,300	110.0	49.4	23,100
105.0	40.2	25,700	110.0	41.8	23,800	115.0	43.2	22,000	115.0	47.0	21,600
110.0	36.6	24,200	115.0	38.6	22,200	120.0	40.3	20,700	120.0	44.4	20,200
115.0	32.6	22,700 *	120.0	35.2	20,900	125.0	37.2	19,400	125.0	41.8	18,900
			125.0	31.4	19,600 *	130.0	33.9	18,200 *	130.0	39.0	17,800
						135.0	30.2	16,500 *	135.0	36.0	16,700
									140.0	32.8	15,600 *

170' Boom			180' Boom			190' Boom			200' Boom		
Load Radius (ft)	Boom Angle (deg.)	360° Rated Load (lbs)	Load Radius (ft)	Boom Angle (deg.)	360° Rated Load (lbs)	Load Radius (ft)	Boom Angle (deg.)	360° Rated Load (lbs)	Load Radius (ft)	Boom Angle (deg.)	360° Rated Load (lbs)
36.0	79.9	102,000 *	38.0	79.8	88,400 *	40.0	79.8	88,100 *	45.0	78.8	75,100 *
38.0	79.2	95,600 *	40.0	79.2	88,400 *	45.0	78.2	76,400 *	50.0	77.3	66,100 *
40.0	78.5	89,900 *	45.0	77.6	77,600 *	50.0	76.7	67,200 *	55.0	75.9	58,800 *
45.0	76.8	78,200 *	50.0	75.9	68,500 *	55.0	75.1	59,900 *	60.0	74.4	52,900 *
50.0	75.1	69,200 *	55.0	74.3	61,000 *	60.0	73.5	53,700	65.0	72.9	47,600
55.0	73.3	61,200	60.0	72.6	54,000	65.0	72.0	48,000	70.0	71.4	42,900
60.0	71.5	54,200	65.0	70.9	48,200	70.0	70.4	43,200	75.0	69.9	38,800
65.0	69.7	48,500	70.0	69.2	43,600	75.0	68.7	39,200	80.0	68.3	35,200
70.0	67.9	43,800	75.0	67.5	39,400	80.0	67.1	35,700	85.0	66.8	32,400
75.0	66.1	39,600	80.0	65.8	36,100	85.0	65.5	32,600	90.0	65.2	29,700
80.0	64.2	36,300	85.0	64.0	33,000	90.0	63.8	29,900	95.0	63.6	27,300
85.0	62.3	33,200	90.0	62.2	30,400	95.0	62.1	27,700	100.0	62.0	25,300
90.0	60.4	30,600	95.0	60.4	27,900	100.0	60.4	25,500	105.0	60.3	23,300
95.0	58.4	28,200	100.0	58.5	26,000	105.0	58.6	23,800	110.0	58.7	21,800
100.0	56.4	26,200	105.0	56.6	24,000	110.0	56.8	22,000	115.0	57.0	20,200
105.0	54.4	24,400	110.0	54.7	22,400	115.0	55.0	20,500	120.0	55.2	18,700
110.0	52.2	22,700	115.0	52.7	20,900	120.0	53.1	19,100	125.0	53.5	17,600
115.0	50.1	21,100	120.0	50.6	19,600	125.0	51.2	18,000	130.0	51.6	16,500
120.0	47.8	19,800	125.0	48.5	18,200	130.0	49.2	16,700	135.0	49.8	15,400
125.0	45.5	18,700	130.0	46.4	17,100	135.0	47.2	15,800	140.0	47.9	14,300
130.0	43.0	17,400	135.0	44.1	16,000	140.0	45.0	14,700	145.0	45.9	13,400
135.0	40.5	16,500	140.0	41.7	15,200	145.0	42.9	13,800	150.0	43.8	12,700
140.0	37.8	15,400	145.0	39.3	14,300	150.0	40.6	13,000	155.0	41.7	11,900
145.0	34.9	14,500	150.0	36.6	13,400 *	155.0	38.2	12,300 *	160.0	39.5	11,200 *
150.0	31.8	13,200 *	155.0	33.8	12,300 *	160.0	35.6	11,200 *	165.0	37.1	10,300 *
			160.0	30.8	11,000 *	165.0	32.9	10,100 *	170.0	34.7	9,200 *
						170.0	30.0	9,000 *	175.0	32.0	8,300 *

## CK1600-II Main Boom Rated Loads

with 11 counterweights (116,840 lbs) and 2 carbody weights (22,050 lbs)

Refer to notes page 19

210 ' Boom			220 ' Boom			230 ' Boom			240 ' Boom		
Load Radius (ft)	Boom Angle (deg.)	360° Rated Load (lbs)	Load Radius (ft)	Boom Angle (deg.)	360° Rated Load (lbs)	Load Radius (ft)	Boom Angle (deg.)	360° Rated Load (lbs)	Load Radius (ft)	Boom Angle (deg.)	360° Rated Load (lbs)
45.0	79.4	73,800 *	45.0	79.8	58,800 *	50.0	79.0	58,800 *	50.0	79.5	54,400 *
50.0	78.0	65,000 *	50.0	78.5	58,800 *	55.0	77.7	55,700 *	55.0	78.3	51,300 *
55.0	76.6	57,700 *	55.0	77.2	57,700 *	60.0	76.5	50,700 *	60.0	77.0	48,200 *
60.0	75.1	51,800 *	60.0	75.8	51,800 *	65.0	75.2	45,800 *	65.0	75.8	44,700 *
65.0	73.7	46,900 *	65.0	74.5	46,700 *	70.0	73.9	41,400 *	70.0	74.6	40,500 *
70.0	72.3	42,500	70.0	73.1	42,300 *	75.0	72.6	37,900 *	75.0	73.3	37,000 *
75.0	70.9	38,300	75.0	71.8	38,300	80.0	71.3	34,600	80.0	72.1	33,700 *
80.0	69.4	34,800	80.0	70.4	34,800	85.0	69.9	31,500	85.0	70.8	31,000 *
85.0	67.9	31,900	85.0	69.0	31,700	90.0	68.6	28,800	90.0	69.5	28,400
90.0	66.5	29,300	90.0	67.6	29,100	95.0	67.3	26,400	95.0	68.3	26,000
95.0	64.9	26,800	95.0	66.2	26,800	100.0	65.9	24,400	100.0	67.0	24,000
100.0	63.4	24,900	100.0	64.7	24,600	105.0	64.5	22,400	105.0	65.7	22,000
105.0	61.9	22,900	105.0	63.3	22,900	110.0	63.1	20,900	110.0	64.3	20,500
110.0	60.3	21,300	110.0	61.8	21,100	115.0	61.7	19,400	115.0	63.0	18,900
115.0	58.7	19,800	115.0	60.3	19,600	120.0	60.3	17,800	120.0	61.7	17,600
120.0	57.1	18,500	120.0	58.8	18,200	125.0	58.8	16,700	125.0	60.3	16,300
125.0	55.5	17,100	125.0	57.2	16,900	130.0	57.4	15,400	130.0	58.9	15,200
130.0	53.8	16,000	130.0	55.7	15,800	135.0	55.9	14,500	135.0	57.5	14,100
135.0	52.1	14,900	135.0	54.1	14,700	140.0	54.3	13,400	140.0	56.0	13,000
140.0	50.3	13,800	140.0	52.4	13,800	145.0	52.8	12,500	145.0	54.6	12,100
145.0	48.5	13,000	145.0	50.8	13,000	150.0	51.2	11,600	150.0	53.1	11,000
150.0	46.6	12,300	150.0	49.1	12,100	155.0	49.6	10,800	155.0	51.6	10,300
155.0	44.7	11,400	155.0	47.3	11,200	160.0	47.9	9,900	160.0	50.0	9,400
160.0	42.7	10,500	160.0	45.5	10,300	165.0	46.2	9,200	165.0	48.5	8,800
165.0	40.6	9,900	165.0	43.6	9,700	170.0	44.4	8,500	170.0	46.8	7,900
170.0	38.5	9,200 *	170.0	41.7	9,000 *	175.0	42.6	7,900 *	175.0	45.2	7,200
175.0	36.2	8,100 *	175.0	39.7	8,100 *	180.0	40.7	7,000 *	180.0	43.4	6,800 *
180.0	33.8	7,200 *	180.0	37.6	7,200 *	185.0	38.7	6,300 *	185.0	41.7	6,100 *
185.0	31.2	6,300 *	185.0	35.3	6,600 *	190.0	36.7	5,700 *	190.0	39.8	5,200 *
			190.0	33.0	5,700 *	195.0	34.5	4,800 *	195.0	37.9	4,600 *
			195.0	30.5	4,800 *	200.0	32.2	4,100 *			
250 ' Boom			250 ' Boom								
Load Radius (ft)	Boom Angle (deg.)	360° Rated Load (lbs)	Load Radius (ft)	Boom Angle (deg.)	360° Rated Load (lbs)						
50.0	79.9	50,200 *	145.0	56.2	11,600						
55.0	78.7	47,300 *	150.0	54.8	10,800						
60.0	77.6	44,500 *	155.0	53.4	9,900						
65.0	76.4	42,100 *	160.0	51.9	9,000						
70.0	75.2	39,600 *	165.0	50.5	8,300						
75.0	74.0	36,100 *	170.0	49.0	7,400						
80.0	72.8	33,000 *	175.0	47.4	6,800						
85.0	71.6	30,200 *	180.0	45.8	6,300 *						
90.0	70.4	27,900 *	185.0	44.2	5,700 *						
95.0	69.2	25,700 *	190.0	42.5	5,000 *						
100.0	67.9	23,500	195.0	40.8	4,400 *						
105.0	66.7	21,800									
110.0	65.4	20,000									
115.0	64.2	18,500									
120.0	62.9	17,100									
125.0	61.6	15,800									
130.0	60.3	14,700									
135.0	58.9	13,600									
140.0	57.6	12,500									



# CK1600-II Jib Rated Loads

with 11 counterweights (116,840 lbs) and 2 carbody weights (22,050 lbs)

Refer to notes page 19

90 ft Boom									90 ft Boom								
Load Radius (ft.)	40' Jib				60' Jib				Load Radius (ft.)	80' Jib				100' Jib			
	10° Offset		30° Offset		10° Offset		30° Offset			10° Offset		30° Offset		10° Offset		30° Offset	
	Boom Angle (deg.)	Rated Load (lbs.)	Boom Angle (deg.)	Rated Load (lbs.)	Boom Angle (deg.)	Rated Load (lbs.)	Boom Angle (deg.)	Rated Load (lbs.)		Boom Angle (deg.)	Rated Load (lbs.)	Boom Angle (deg.)	Rated Load (lbs.)	Boom Angle (deg.)	Rated Load (lbs.)	Boom Angle (deg.)	Rated Load (lbs.)
34	79.5	59,000 *							46	79.7	22,000 *						
36	78.6	59,000 *							48	79.0	21,800 *						
38	77.7	59,000 *							50	78.3	21,600 *						
40	76.8	59,000 *							55	76.6	21,300 *			79.6	13,200 *		
42	75.8	58,800 *					79.6	42,500 *	60	74.8	20,900 *			78.1	13,000 *		
44	74.9	58,200 *					78.8	42,200 *	65	73.0	20,600 *			76.5	12,700 *		
46	74.0	57,600 *	79.5	40,100 *	77.2	41,700 *			70	71.2	20,000 *	79.7	16,700 *	73.4	12,100 *		
48	73.1	57,000 *	78.5	39,200 *	76.5	41,500 *			75	69.4	19,400 *	77.8	16,300 *	71.8	11,600 *		
50	72.2	56,400 *	77.5	38,200 *	75.7	41,300 *			80	67.5	18,700 *	75.9	15,900 *	70.1	11,200 *	79.8	9,100 *
55	69.8	55,100 *	75.1	36,100 *	73.7	40,300 *			85	65.7	18,100 *	74.0	15,500 *	68.5	10,800 *	78.1	8,900 *
60	67.4	53,900 *	72.7	34,300 *	71.6	39,300 *	78.8	27,000 *	90	63.7	17,600 *	72.0	15,200 *	66.8	10,400 *	76.4	8,600 *
65	65.0	51,000 *	70.2	32,600 *	69.6	38,400 *	76.6	25,500 *	95	61.8	17,100 *	69.9	14,900 *	65.1	10,000 *	74.6	8,400 *
70	62.5	47,200 *	67.6	31,200 *	67.5	36,100 *	74.5	24,200 *	100	59.8	16,600 *	67.9	14,500 *	63.4	9,700 *	72.8	8,200 *
75	59.9	43,100 *	64.9	29,800 *	65.4	33,600 *	72.3	23,100 *	105	57.7	16,200 *	65.7	13,900 *	61.7	9,400 *	71.0	8,000 *
80	57.3	39,600 *	62.2	28,700 *	63.2	31,500 *	70.0	22,000 *	110	55.6	15,800 *	63.5	13,500 *	59.9	9,100 *	69.2	7,800 *
85	54.5	36,600 *	59.4	27,600 *	61.0	29,600 *	67.7	21,100 *	115	53.5	15,400 *	61.3	13,000 *	58.1	8,800 *	67.3	7,600 *
90	51.7	33,900 *	56.5	26,700 *	58.7	27,900 *	65.4	20,200 *	120	51.2	15,000 *	58.9	12,600 *	56.2	8,500 *	65.4	7,400 *
95	48.8	31,600 *	53.4	25,900 *	56.3	26,400 *	62.9	19,400 *	125	48.9	14,700 *	56.5	12,200 *	54.3	8,300 *	63.4	7,300 *
100	45.6	29,500 *	50.1	25,100 *	53.9	25,100 *	60.4	18,700 *	130	46.5	14,400 *	53.9	11,900 *	52.3	8,100 *	61.3	7,100 *
105	42.3	27,700 *	46.1	24,500 *	51.4	23,900 *	57.8	18,100 *	135	43.9	14,100 *	51.2	11,500 *	50.3	7,900 *	59.2	7,000 *
110	38.8	26,000 *	42.9	23,900 *	48.8	22,800 *	55.1	17,500 *	140	41.3	13,900 *	48.3	11,200 *	48.2	7,700 *	57.0	6,900 *
115	34.9	24,400 *			46.1	21,800 *	52.2	17,000 *	145	38.4	13,600 *	45.2	11,000 *	46.0	7,500 *	54.7	6,800 *
120	30.6	21,900 *			43.2	20,900 *	49.2	16,600 *	150	35.4	13,400 *	41.9	10,800 *	43.8	7,300 *	52.3	6,700 *
125					40.2	20,100 *	45.9	16,100 *	155	32.0	13,200 *			41.4	7,100 *	49.8	6,600 *
130					36.9	19,400 *	42.3	15,800 *	160					38.9	7,000 *	47.1	6,500 *
135					33.3	18,700 *			165					36.2	6,900 *	44.2	6,500 *
									170					33.3	6,700 *	41.0	6,400 *
									175					30.2	6,600 *		

100 ft Boom									100 ft Boom								
Load Radius (ft.)	40' Jib				60' Jib				Load Radius (ft.)	80' Jib				100' Jib			
	10° Offset		30° Offset		10° Offset		30° Offset			10° Offset		30° Offset		10° Offset		30° Offset	
	Boom Angle (deg.)	Rated Load (lbs.)	Boom Angle (deg.)	Rated Load (lbs.)	Boom Angle (deg.)	Rated Load (lbs.)	Boom Angle (deg.)	Rated Load (lbs.)		Boom Angle (deg.)	Rated Load (lbs.)	Boom Angle (deg.)	Rated Load (lbs.)	Boom Angle (deg.)	Rated Load (lbs.)	Boom Angle (deg.)	Rated Load (lbs.)
36	79.4	59,000 *							48	79.6	21,900 *						
38	78.6	59,000 *							50	79.0	21,800 *						
40	77.7	59,000 *							55	77.3	21,400 *			78.7	13,100 *		
42	76.9	59,000 *					79.5	42,400 *	60	75.7	21,100 *			77.2	12,800 *		
44	76.0	58,900 *					78.8	42,200 *	65	74.0	20,800 *			75.7	12,500 *		
46	75.2	58,300 *					78.1	41,900 *	70	72.3	20,500 *			74.2	12,300 *		
48	74.3	57,700 *	79.4	40,000 *	77.3	41,700 *			75	70.6	19,800 *	78.6	16,400 *	72.7	11,900 *		
50	73.5	57,200 *	78.5	39,100 *	76.6	41,500 *			80	68.9	19,200 *	76.8	16,000 *	71.2	11,500 *		
55	71.3	55,900 *	76.3	37,100 *	74.7	40,800 *			85	67.1	18,600 *	75.0	15,700 *	69.6	11,000 *	78.7	8,900 *
60	69.1	54,700 *	74.0	35,200 *	72.8	39,900 *	79.5	27,600 *	90	65.3	18,000 *	73.1	15,400 *	68.1	10,700 *	77.1	8,700 *
65	66.9	51,600 *	71.7	33,600 *	70.9	39,000 *	77.6	26,100 *	95	63.5	17,500 *	71.2	15,100 *	66.5	10,300 *	75.5	8,500 *
70	64.6	46,900 *	69.4	32,100 *	69.0	38,000 *	75.6	24,900 *	100	61.7	17,100 *	69.3	14,800 *	64.9	10,000 *	73.8	8,300 *
75	62.3	42,800 *	67.0	30,800 *	67.0	35,500 *	73.5	23,700 *	105	59.8	16,600 *	67.4	14,300 *	63.2	9,700 *	72.1	8,100 *
80	59.9	39,300 *	64.6	29,600 *	65.0	33,200 *	71.5	22,700 *	110	57.9	16,200 *	65.4	13,800 *	61.6	9,300 *	70.4	7,900 *
85	57.5	36,300 *	62.0	28,600 *	63.0	31,300 *	69.4	21,700 *	115	55.9	15,800 *	63.3	13,400 *	59.9	9,100 *	68.7	7,700 *
90	55.0	33,600 *	59.4	27,600 *	60.9	29,500 *	67.2	20,800 *	120	53.9	15,400 *	61.2	13,000 *	58.2	8,800 *	66.9	7,500 *
95	52.4	31,300 *	56.7	26,800 *	58.8	27,900 *	65.0	20,100 *	125	51.8	15,100 *	59.0	12,600 *	56.4	8,500 *	65.1	7,400 *
100	49.6	29,200 *	53.9	26,000 *	56.6	26,600 *	62.7	19,400 *	130	49.6	14,800 *	56.7	12,200 *	54.6	8,300 *	63.2	7,200 *
105	46.8	27,300 *	51.0	25,300 *	54.3	25,300 *	60.4	18,700 *	135	47.4	14,500 *	54.3	11,900 *	52.7	8,100 *	61.3	7,100 *
110	43.8	25,600 *	47.9	24,700 *	52.0	24,100 *	58.0	18,100 *	140	45.0	14,200 *	51.9	11,600 *	50.8	7,900 *	59.3	7,000 *
115	40.7	24,100 *	44.5	24,100 *	49.6	23,100 *	55.5	17,600 *	145	42.6	14,000 *	49.2	11,300 *	48.9	7,700 *	57.2	6,900 *
120	37.3	22,700 *	40.9	23,000 *	47.1	22,100 *	52.8	17,100 *	150	40.0	13,700 *	46.4	11,100 *	46.8	7,500 *	55.1	6,800 *
125	33.5	21,100 *			44.5	21,300 *	50.1	16,700 *	155	37.2	13,500 *	43.4	10,800 *	44.7	7,400 *	52.8	6,700 *
130					41.7	20,500 *	47.1	16,300 *	160	34.2	13,300 *	40.2	10,600 *	42.5	7,200 *	50.5	6,600 *
135					38.8	19,700 *	43.9	15,900 *	165	31.0	13,200 *			40.2	7,000 *	48.0	6,500 *
140					35.6	18,600 *	40.5	15,600 *	170					37.8	6,900 *	45.4	6,500 *
145					32.1	17,000 *			175					35.2	6,800 *	42.6	6,400 *
									180					32.4	6,700 *		

# CK1600-II Jib Rated Loads

with 11 counterweights (116,840 lbs) and 2 carbody weights (22,050 lbs)

Refer to notes page 19

110 ft Boom									110 ft Boom								
Load Radius (ft.)	40' Jib				60' Jib				Load Radius (ft.)	80' Jib				100' Jib			
	10° Offset		30° Offset		10° Offset		30° Offset			10° Offset		30° Offset		10° Offset		30° Offset	
	Boom Angle (deg.)	Rated Load (lbs.)	Boom Angle (deg.)	Rated Load (lbs.)	Boom Angle (deg.)	Rated Load (lbs.)	Boom Angle (deg.)	Rated Load (lbs.)		Boom Angle (deg.)	Rated Load (lbs.)	Boom Angle (deg.)	Rated Load (lbs.)	Boom Angle (deg.)	Rated Load (lbs.)	Boom Angle (deg.)	Rated Load (lbs.)
38	79.3	59,000 *							50	79.6	21,900 *						
40	78.6	59,000 *							55	78.0	21,600 *			79.3	13,100 *		
42	77.8	59,000 *							60	76.5	21,200 *			77.8	12,900 *		
44	77.0	59,000 *							65	74.9	20,900 *			76.4	12,600 *		
46	76.2	58,900 *							70	73.3	20,600 *			75.0	12,400 *		
48	75.4	58,400 *							75	71.7	20,200 *		79.2	16,600 *	73.6	12,200 *	
50	74.6	57,800 *	79.3	39,900 *	77.4	41,700 *			80	70.1	19,600 *	77.6	16,200 *	72.1	11,700 *		
55	72.6	56,600 *	77.3	37,900 *	75.6	41,200 *			85	68.4	19,000 *	75.9	15,800 *	70.7	11,300 *	79.3	9,000 *
60	70.6	55,400 *	75.2	36,100 *	73.9	40,300 *			90	66.8	18,400 *	74.1	15,500 *	69.2	10,900 *	77.8	8,800 *
65	68.5	51,300 *	73.1	34,500 *	72.1	39,500 *	78.4	26,700 *	95	65.1	17,900 *	72.4	15,200 *	67.7	10,600 *	76.3	8,500 *
70	66.4	46,500 *	70.9	33,000 *	70.3	38,600 *	76.5	25,400 *	100	63.3	17,500 *	70.6	14,900 *	66.2	10,200 *	74.7	8,300 *
75	64.3	42,500 *	68.8	31,700 *	68.5	37,300 *	74.6	24,300 *	105	61.6	17,000 *	68.8	14,700 *	64.6	9,900 *	73.1	8,200 *
80	62.1	38,900 *	66.5	30,500 *	66.6	35,000 *	72.7	23,300 *	110	59.8	16,600 *	66.9	14,200 *	63.1	9,600 *	71.5	8,000 *
85	59.9	35,900 *	64.2	29,500 *	64.7	32,900 *	70.8	22,300 *	115	58.0	16,200 *	65.0	13,800 *	61.5	9,300 *	69.9	7,800 *
90	57.6	33,300 *	61.9	28,500 *	62.8	31,100 *	68.8	21,400 *	120	56.1	15,800 *	63.1	13,300 *	59.9	9,100 *	68.2	7,600 *
95	55.3	30,900 *	59.5	27,600 *	60.8	29,400 *	66.8	20,700 *	125	54.2	15,500 *	61.1	12,900 *	58.3	8,800 *	66.5	7,500 *
100	52.9	28,800 *	57.0	26,800 *	58.8	28,000 *	64.7	19,900 *	130	52.2	15,200 *	59.1	12,600 *	56.6	8,600 *	64.8	7,300 *
105	50.4	27,000 *	54.4	26,100 *	56.8	26,600 *	62.6	19,300 *	135	50.2	14,900 *	56.9	12,200 *	54.9	8,300 *	63.0	7,200 *
110	47.8	25,300 *	51.7	25,400 *	54.7	25,400 *	60.4	18,700 *	140	48.1	14,600 *	54.7	11,900 *	53.1	8,100 *	61.2	7,100 *
115	45.1	23,800 *	48.9	24,100 *	52.5	24,200 *	58.1	18,100 *	145	45.9	14,300 *	52.4	11,600 *	51.3	7,900 *	59.3	7,000 *
120	42.2	22,400 *	45.9	22,700 *	50.3	22,800 *	55.8	17,600 *	150	43.7	14,100 *	50.0	11,400 *	49.5	7,800 *	57.4	6,900 *
125	39.2	21,100 *	42.6	21,400 *	48.0	21,500 *	53.3	17,200 *	155	41.3	13,800 *	47.5	11,100 *	47.6	7,600 *	55.4	6,800 *
130	35.9	20,000 *			45.6	20,400 *	50.8	16,700 *	160	38.8	13,600 *	44.7	10,900 *	45.6	7,400 *	53.3	6,700 *
135	32.3	18,200 *			43.0	19,300 *	48.1	16,400 *	165	36.1	13,400 *	41.8	10,700 *	43.5	7,200 *	51.1	6,600 *
140					40.4	18,300 *	45.3	16,000 *	170	33.2	13,300 *			41.4	7,100 *	48.8	6,500 *
145					37.5	17,400 *	42.2	15,700 *	175	30.0	12,500 *			39.2	7,000 *	46.4	6,500 *
150					34.4	16,200 *			180					36.8	6,900 *	43.8	6,400 *
155					31.1	14,800 *			185					34.2	6,700 *	41.1	6,400 *
									190					31.5	6,700 *		

120 ft Boom									120 ft Boom								
Load Radius (ft.)	40' Jib				60' Jib				Load Radius (ft.)	80' Jib				100' Jib			
	10° Offset		30° Offset		10° Offset		30° Offset			10° Offset		30° Offset		10° Offset		30° Offset	
	Boom Angle (deg.)	Rated Load (lbs.)	Boom Angle (deg.)	Rated Load (lbs.)	Boom Angle (deg.)	Rated Load (lbs.)	Boom Angle (deg.)	Rated Load (lbs.)		Boom Angle (deg.)	Rated Load (lbs.)	Boom Angle (deg.)	Rated Load (lbs.)	Boom Angle (deg.)	Rated Load (lbs.)	Boom Angle (deg.)	Rated Load (lbs.)
38	80.0	59,000 *							55	78.6	21,700 *			79.7	13,200 *		
40	79.3	59,000 *							60	77.2	21,400 *			78.4	13,000 *		
42	78.5	59,000 *							65	75.7	21,000 *			77.1	12,700 *		
44	77.8	59,000 *							70	74.2	20,800 *			75.7	12,500 *		
46	77.1	59,000 *							75	72.7	20,500 *		79.8	16,700 *	74.4	12,300 *	
48	76.3	59,000 *							80	71.1	19,900 *	78.2	16,300 *	73.0	12,000 *		
50	75.6	58,500 *	80.0	40,600 *	78.1	41,900 *			85	69.6	19,400 *	76.6	16,000 *	71.6	11,500 *		9,100 *
55	73.7	57,200 *	78.1	38,700 *	76.5	41,400 *			90	68.0	18,800 *	75.0	15,700 *	70.2	11,100 *	78.4	8,900 *
60	71.8	56,100 *	76.2	36,900 *	74.8	40,700 *			95	66.4	18,300 *	73.4	15,400 *	68.8	10,800 *	77.0	8,600 *
65	69.9	50,900 *	74.2	35,300 *	73.1	39,900 *	79.1	27,200 *	100	64.8	17,900 *	71.7	15,100 *	67.3	10,500 *	75.5	8,400 *
70	68.0	46,100 *	72.2	33,900 *	71.4	39,100 *	77.3	25,900 *	105	63.2	17,400 *	70.0	14,900 *	65.9	10,100 *	74.0	8,200 *
75	66.0	42,000 *	70.2	32,600 *	69.7	38,400 *	75.6	24,800 *	110	61.5	17,000 *	68.3	14,600 *	64.4	9,800 *	72.5	8,100 *
80	64.0	38,500 *	68.2	31,400 *	68.0	36,600 *	73.8	23,800 *	115	59.8	16,600 *	66.6	14,100 *	62.9	9,600 *	71.0	7,900 *
85	62.0	35,400 *	66.1	30,300 *	66.2	34,500 *	72.0	22,900 *	120	58.1	16,200 *	64.8	13,700 *	61.4	9,300 *	69.4	7,700 *
90	59.9	32,800 *	64.0	29,300 *	64.5	32,600 *	70.1	22,000 *	125	56.3	15,900 *	62.9	13,300 *	59.9	9,000 *	67.8	7,600 *
95	57.8	30,400 *	61.8	28,400 *	62.6	30,900 *	68.3	21,200 *	130	54.5	15,500 *	61.0	12,900 *	58.3	8,800 *	66.2	7,400 *
100	55.6	28,300 *	59.5	27,600 *	60.8	28,800 *	66.3	20,500 *	135	52.7	15,200 *	59.1	12,600 *	56.7	8,600 *	64.5	7,300 *
105	53.4	26,500 *	57.2	26,800 *	58.9	26,900 *	64.4	19,800 *	140	50.8	14,900 *	57.1	12,300 *	55.1	8,300 *	62.8	7,200 *
110	51.1	24,800 *	54.8	25,300 *	57.0	25,200 *	62.4	19,200 *	145	48.8	14,700 *	55.0	11,900 *	53.5	8,200 *	61.1	7,100 *
115	48.7	23,300 *	52.3	23,700 *	55.0	23,700 *	60.3	18,700 *	150	46.8	14,400 *	52.9	11,700 *	51.8	8,000 *	59.3	7,000 *
120	46.2	21,900 *	49.7	22,300 *	53.0	22,300 *	58.2	18,200 *	155	44.6	14,100 *	50.7	11,400 *	50.0	7,800 *	57.5	6,900 *
125	43.5	20,600 *	47.0	21,000 *	50.9	21,000 *	56.1	17,700 *	160	42.4	13,900 *	48.3	11,200 *	48.2	7,600 *	55.6	6,800 *
130	40.8	19,500 *	44.1	19,800 *	48.7	19,900 *	53.8	17,200 *	165	40.1	13,700 *	45.8	11,000 *	46.4	7,500 *	53.7	6,700 *
135	37.8	18,400 *	41.0	18,700 *	46.5	18,800 *	51.4	16,800 *	170	37.7	13,500 *	43.2	10,800 *	44.4	7,300 *	51.6	6,600 *
140	34.7	17,100 *			44.1	17,800 *	49.0	16,500 *	175	35.1	12,700 *	40.3	10,600 *	42.4	7,200 *	49.5	6,500 *
145	31.2	15,500 *			41.7	16,900 *	46.4	16,200 *	180	32.3	11,700 *			40.3	7,000 *	47.3	6,500 *
150					39.1	16,100 *	43.6	15,800 *	185					38.2	6,900 *	44.9	6,400 *
155					36.4	15,100 *	40.6	15,600 *	190					35.8	6,800 *	42.4	6,400 *
160					33.4	13,800 *			195					33.4	6,700 *		
165					30.1	12,600 *			200					30.7	6,600 *		

# CK1600-II Jib Rated Loads

with 11 counterweights (116,840 lbs) and 2 carbody weights (22,050 lbs)

Refer to notes page 19

130 ft Boom									130 ft Boom								
Load Radius (ft.)	40' Jib				60' Jib				Load Radius (ft.)	80' Jib				100' Jib			
	10° Offset		30° Offset		10° Offset		30° Offset			10° Offset		30° Offset		10° Offset		30° Offset	
	Boom Angle (deg.)	Rated Load (lbs.)	Boom Angle (deg.)	Rated Load (lbs.)	Boom Angle (deg.)	Rated Load (lbs.)	Boom Angle (deg.)	Rated Load (lbs.)		Boom Angle (deg.)	Rated Load (lbs.)	Boom Angle (deg.)	Rated Load (lbs.)	Boom Angle (deg.)	Rated Load (lbs.)	Boom Angle (deg.)	Rated Load (lbs.)
40	79.9	59,000 *							55	79.2	21,800 *						
42	79.2	59,000 *							60	77.8	21,500 *			78.9	13,000 *		
44	78.5	59,000 *							65	76.4	21,200 *			77.6	12,800 *		
46	77.9	59,000 *							70	74.9	20,900 *			76.4	12,600 *		
48	77.2	59,000 *			80.0	42,400 *			75	73.5	20,600 *			75.1	12,400 *		
50	76.5	59,000 *			79.4	42,200 *			80	72.1	20,300 *	78.9	16,400 *	73.7	12,200 *		
55	74.7	57,800 *	78.8	39,400 *	77.2	41,600 *			85	70.6	19,700 *	77.3	16,100 *	72.4	11,800 *		
60	73.0	56,400 *	77.0	37,600 *	75.6	41,100 *			90	69.1	19,200 *	75.8	15,800 *	71.1	11,400 *	79.0	8,900 *
65	71.2	50,600 *	75.2	36,100 *	74.1	40,300 *	79.7	27,700 *	95	67.6	18,700 *	74.3	15,500 *	69.8	11,000 *	77.6	8,700 *
70	69.4	45,800 *	73.4	34,600 *	72.5	39,500 *	78.0	26,400 *	100	66.1	18,200 *	72.7	15,200 *	68.4	10,700 *	76.2	8,500 *
75	67.5	41,700 *	71.5	33,300 *	70.9	38,800 *	76.4	25,300 *	105	64.6	17,800 *	71.1	15,000 *	67.0	10,400 *	74.8	8,300 *
80	65.7	38,200 *	69.6	32,200 *	69.2	38,100 *	74.7	24,300 *	110	63.0	17,300 *	69.5	14,800 *	65.6	10,100 *	73.4	8,200 *
85	63.8	35,100 *	67.7	31,100 *	67.6	35,700 *	73.0	23,400 *	115	61.4	16,900 *	67.9	14,400 *	64.2	9,800 *	71.9	8,000 *
90	61.9	32,500 *	65.7	30,100 *	65.9	33,000 *	71.3	22,500 *	120	59.8	16,600 *	66.2	14,000 *	62.8	9,500 *	70.4	7,800 *
95	59.9	30,100 *	63.7	29,200 *	64.2	30,600 *	69.6	21,800 *	125	58.2	16,200 *	64.5	13,600 *	61.4	9,300 *	68.9	7,700 *
100	57.9	28,000 *	61.7	28,300 *	62.5	28,500 *	67.8	21,000 *	130	56.5	15,900 *	62.8	13,200 *	59.9	9,000 *	67.4	7,500 *
105	55.9	26,100 *	59.6	26,800 *	60.8	26,600 *	66.0	20,400 *	135	54.8	15,600 *	61.0	12,900 *	58.4	8,800 *	65.9	7,400 *
110	53.8	24,500 *	57.4	25,000 *	59.0	24,900 *	64.1	19,700 *	140	53.0	15,300 *	59.2	12,600 *	56.9	8,600 *	64.3	7,300 *
115	51.6	22,900 *	55.2	23,400 *	57.1	23,400 *	62.3	19,200 *	145	51.2	15,000 *	57.3	12,300 *	55.3	8,400 *	62.7	7,200 *
120	49.4	21,600 *	52.8	22,000 *	55.3	22,000 *	60.3	18,600 *	150	49.4	14,700 *	55.3	12,000 *	53.8	8,200 *	61.1	7,000 *
125	47.1	20,300 *	50.4	20,700 *	53.4	20,700 *	58.3	18,200 *	155	47.5	14,500 *	53.3	11,700 *	52.1	8,000 *	59.4	6,900 *
130	44.7	19,100 *	47.9	19,500 *	51.4	19,500 *	56.3	17,700 *	160	45.5	14,200 *	51.2	11,500 *	50.5	7,800 *	57.6	6,900 *
135	42.1	18,100 *	45.3	18,400 *	49.4	18,500 *	54.2	17,300 *	165	43.5	13,900 *	49.1	11,200 *	48.8	7,700 *	55.9	6,800 *
140	39.4	17,100 *	42.5	17,300 *	47.3	17,500 *	52.0	16,900 *	170	41.3	13,300 *	46.8	11,000 *	47.0	7,500 *	54.0	6,700 *
145	36.6	16,000 *			45.1	16,600 *	49.7	16,600 *	175	39.0	12,700 *	44.3	10,900 *	45.2	7,400 *	52.1	6,600 *
150	33.5	14,600 *			42.8	15,700 *	47.3	16,200 *	180	36.7	11,900 *	41.8	10,700 *	43.3	7,200 *	50.1	6,500 *
155	30.2	13,200 *			40.5	14,900 *	44.8	15,500 *	185	34.1	11,000 *			41.4	7,100 *	48.1	6,500 *
160					38.0	14,100 *	42.1	14,700 *	190	31.4	10,000 *			39.4	7,000 *	45.9	6,400 *
165					35.3	13,000 *			195					37.2	6,900 *	43.6	6,400 *
170					32.4	11,900 *			200					35.0	6,800 *	41.1	6,400 *
									205					32.5	6,700 *		

140 ft Boom									140 ft Boom								
Load Radius (ft.)	40' Jib				60' Jib				Load Radius (ft.)	80' Jib				100' Jib			
	10° Offset		30° Offset		10° Offset		30° Offset			10° Offset		30° Offset		10° Offset		30° Offset	
	Boom Angle (deg.)	Rated Load (lbs.)	Boom Angle (deg.)	Rated Load (lbs.)	Boom Angle (deg.)	Rated Load (lbs.)	Boom Angle (deg.)	Rated Load (lbs.)		Boom Angle (deg.)	Rated Load (lbs.)	Boom Angle (deg.)	Rated Load (lbs.)	Boom Angle (deg.)	Rated Load (lbs.)	Boom Angle (deg.)	Rated Load (lbs.)
42	79.8	59,000 *							55	79.7	21,900 *						
44	79.2	59,000 *							60	78.4	21,600 *			79.4	13,100 *		
46	78.5	59,000 *							65	77.0	21,300 *			78.2	12,900 *		
48	77.9	59,000 *							70	75.7	21,000 *			76.9	12,700 *		
50	77.2	59,000 *			79.9	42,400 *			75	74.3	20,800 *			75.7	12,500 *		
55	75.6	58,400 *	79.5	40,000 *	77.8	41,700 *			80	72.9	20,500 *	79.4	16,500 *	74.4	12,300 *		
60	73.9	56,100 *	77.8	38,300 *	76.4	41,300 *			85	71.5	20,100 *	78.0	16,200 *	73.2	12,000 *		
65	72.3	50,300 *	76.1	36,700 *	74.9	40,700 *			90	70.1	19,500 *	76.5	15,900 *	71.9	11,600 *	79.5	9,000 *
70	70.6	45,500 *	74.4	35,400 *	73.4	39,900 *	78.7	26,900 *	95	68.7	19,000 *	75.1	15,600 *	70.6	11,300 *	78.2	8,800 *
75	68.9	41,400 *	72.6	34,100 *	71.9	39,200 *	77.1	25,800 *	100	67.3	18,600 *	73.6	15,400 *	69.4	10,900 *	76.8	8,600 *
80	67.1	37,800 *	70.9	32,900 *	70.3	38,400 *	75.6	24,800 *	105	65.8	18,100 *	72.1	15,100 *	68.1	10,600 *	75.5	8,400 *
85	65.4	34,800 *	69.1	31,800 *	68.8	35,300 *	74.0	23,900 *	110	64.4	17,700 *	70.6	14,900 *	66.7	10,300 *	74.1	8,200 *
90	63.6	32,100 *	67.2	30,800 *	67.2	32,600 *	72.4	23,000 *	115	62.9	17,300 *	69.1	14,700 *	65.4	10,000 *	72.8	8,100 *
95	61.8	29,800 *	65.4	29,900 *	65.6	30,300 *	70.7	22,200 *	120	61.4	16,900 *	67.5	14,300 *	64.1	9,700 *	71.4	7,900 *
100	59.9	27,700 *	63.5	28,400 *	64.0	28,200 *	69.1	21,500 *	125	59.8	16,600 *	65.9	13,900 *	62.7	9,500 *	70.0	7,800 *
105	58.0	25,800 *	61.6	26,500 *	62.4	26,300 *	67.4	20,800 *	130	58.3	16,200 *	64.3	13,500 *	61.3	9,200 *	68.5	7,600 *
110	56.1	24,100 *	59.6	24,700 *	60.7	24,600 *	65.7	20,200 *	135	56.7	15,900 *	62.6	13,200 *	59.9	9,000 *	67.1	7,500 *
115	54.1	22,600 *	57.5	23,100 *	59.0	23,000 *	63.9	19,700 *	140	55.0	15,600 *	60.9	12,800 *	58.5	8,800 *	65.6	7,400 *
120	52.1	21,200 *	55.5	21,700 *	57.3	21,600 *	62.1	19,100 *	145	53.4	15,300 *	59.2	12,500 *	57.0	8,600 *	64.1	7,200 *
125	50.0	19,900 *	53.3	20,400 *	55.5	20,300 *	60.3	18,600 *	150	51.7	15,000 *	57.4	12,300 *	55.5	8,400 *	62.6	7,100 *
130	47.9	18,800 *	51.1	19,200 *	53.7	19,200 *	58.4	18,200 *	155	49.9	14,800 *	55.6	12,000 *	54.0	8,200 *	61.0	7,000 *
135	45.6	17,700 *	48.7	18,000 *	51.9	18,100 *	56.5	17,700 *	160	48.1	14,300 *	53.7	11,700 *	52.5	8,000 *	59.4	6,900 *
140	43.3	16,700 *	46.3	17,000 *	50.0	17,100 *	54.5	17,300 *	165	46.3	13,600 *	51.7	11,500 *	50.9	7,900 *	57.8	6,900 *
145	40.8	15,800 *	43.7	16,100 *	48.0	16,200 *	52.5	16,900 *	170	44.3	13,000 *	49.7	11,300 *	49.3	7,700 *	56.1	6,800 *
150	38.3	14,900 *	41.0	15,200 *	46.0	15,300 *	50.3	16,000 *	175	42.3	12,300 *	47.6	11,100 *	47.6	7,600 *	54.3	6,700 *
155	35.5	13,600 *			43.9	14,600 *	48.1	15,200 *	180	40.2	11,800 *	45.3	10,900 *	45.9	7,400 *	52.5	6,600 *
160	32.5	12,400 *			41.7	13,800 *	45.8	14,400 *	185	38.1	11,000 *	43.0	10,800 *	44.2	7,300 *	50.7	6,500 *
165					39.3	13,000 *	43.3	13,700 *	190	35.7	10,200 *	40.5	10,600 *	42.3	7,100 *	48.7	6,500 *
170					36.9	12,100 *	40.7	13,000 *	195	33.3	9,300 *			40.4	7,000 *	46.7	6,400 *
175					34.3	11,100 *			200	30.6	8,500 *			38.4	6,900 *	44.6	6,400 *
180					31.5	10,100 *			205					36.4	6,800 *	42.3	6,400 *
									210					34.1	6,700 *		
									215					31.8	6,600 *		

# CK1600-II Jib Rated Loads

with 11 counterweights (116,840 lbs) and 2 carbody weights (22,050 lbs)

Refer to notes page 19

150 ft Boom									150 ft Boom								
Load Radius (ft.)	40' Jib				60' Jib				Load Radius (ft.)	80' Jib				100' Jib			
	10° Offset		30° Offset		10° Offset		30° Offset			10° Offset		30° Offset		10° Offset		30° Offset	
	Boom Angle (deg.)	Rated Load (lbs.)	Boom Angle (deg.)	Rated Load (lbs.)	Boom Angle (deg.)	Rated Load (lbs.)	Boom Angle (deg.)	Rated Load (lbs.)		Boom Angle (deg.)	Rated Load (lbs.)	Boom Angle (deg.)	Rated Load (lbs.)	Boom Angle (deg.)	Rated Load (lbs.)	Boom Angle (deg.)	Rated Load (lbs.)
44	79.8	59,000 *							60	78.9	21,700 *			79.8	13,200 *		
46	79.1	59,000 *							65	77.6	21,400 *			78.7	13,000 *		
48	78.5	59,000 *							70	76.3	21,100 *			77.5	12,800 *		
50	77.9	59,000 *							75	75.0	20,900 *			76.3	12,600 *		
55	76.4	58,900 *							80	73.7	20,600 *	79.9	16,600 *	75.1	12,400 *		
60	74.8	55,700	78.5	38,900 *	77.0	41,500 *			85	72.4	20,400 *	78.5	16,300 *	73.9	12,200 *		
65	73.2	49,900	76.9	37,400 *	75.6	41,000 *			90	71.0	19,900 *	77.2	16,000 *	72.7	11,800 *	79.9	9,000 *
70	71.6	45,000	75.3	36,000 *	74.2	40,300 *	79.3	27,300 *	95	69.7	19,400 *	75.8	15,800 *	71.5	11,500 *	78.7	8,800 *
75	70.0	40,900	73.6	34,700 *	72.8	39,600 *	77.8	26,200 *	100	68.3	18,900 *	74.4	15,500 *	70.2	11,100 *	77.4	8,700 *
80	68.4	37,400	72.0	33,600 *	71.3	38,000	76.3	25,200 *	105	67.0	18,400 *	73.0	15,300 *	69.0	10,800 *	76.1	8,500 *
85	66.8	34,300	70.3	32,500 *	69.8	34,900	74.8	24,300 *	110	65.6	18,000 *	71.6	15,000 *	67.7	10,500 *	74.9	8,300 *
90	65.1	31,700	68.6	31,500 *	68.4	32,200	73.3	23,500 *	115	64.2	17,600 *	70.1	14,800 *	66.5	10,200 *	73.6	8,200 *
95	63.4	29,300	66.9	30,200	66.9	29,800	71.7	22,700 *	120	62.7	17,300 *	68.6	14,600 *	65.2	9,900 *	72.2	8,000 *
100	61.7	27,200	65.1	28,000	65.4	27,700	70.2	22,000 *	125	61.3	16,900 *	67.1	14,200 *	63.9	9,700 *	70.9	7,800 *
105	59.9	25,300	63.3	26,100	63.8	25,800	68.6	21,300 *	130	59.8	16,600 *	65.6	13,800 *	62.6	9,500 *	69.5	7,700 *
110	58.2	23,600	61.5	24,300	62.3	24,100	67.0	20,700 *	135	58.3	16,200 *	64.1	13,500 *	61.3	9,200 *	68.2	7,600 *
115	56.3	22,100	59.6	22,700	60.7	22,600	65.4	20,100 *	140	56.8	15,900 *	62.5	13,100 *	59.9	9,000 *	66.8	7,400 *
120	54.5	20,700	57.7	21,300	59.1	21,200	63.7	19,600 *	145	55.3	15,600 *	60.9	12,800 *	58.5	8,800 *	65.4	7,300 *
125	52.6	19,400	55.7	20,000	57.4	19,900	62.0	19,100 *	150	53.7	15,300 *	59.2	12,500 *	57.2	8,600 *	63.9	7,200 *
130	50.6	18,300	53.7	18,800	55.8	18,700	60.3	18,600 *	155	52.1	14,600	57.6	12,300 *	55.7	8,400 *	62.5	7,100 *
135	48.6	17,200	51.6	17,600	54.0	17,600	58.5	18,200 *	160	50.4	13,900	55.8	12,000 *	54.3	8,200 *	61.0	7,000 *
140	46.5	16,200	49.4	16,600	52.3	16,600	56.7	17,500	165	48.7	13,200	54.0	11,800 *	52.8	8,000 *	59.4	6,900 *
145	44.3	15,300	47.2	15,600	50.5	15,700	54.8	16,600	170	47.0	12,500	52.2	11,500 *	51.3	7,900 *	57.9	6,800 *
150	42.0	14,500	44.8	14,800	48.6	14,900	52.9	15,600	175	45.1	11,900	50.3	11,300 *	49.8	7,700 *	56.3	6,700 *
155	39.7	13,500 *	42.3	13,900	46.7	14,100	50.9	14,800	180	43.3	11,300	48.3	11,100 *	48.2	7,600 *	54.6	6,700 *
160	37.2	12,400 *			44.8	13,400	48.8	14,000	185	41.3	10,800 *	46.2	11,000 *	46.6	7,400 *	52.9	6,600 *
165	34.5	11,300 *			42.7	12,600	46.7	13,300	190	39.3	10,000 *	44.0	10,700	44.9	7,300 *	51.1	6,500 *
170	31.6	10,200 *			40.6	11,800 *	44.4	12,600	195	37.1	9,200 *	41.7	10,100 *	43.2	7,200 *	49.3	6,500 *
175					38.3	10,900 *	42.0	11,900	200	34.9	8,400 *			41.4	7,100 *	47.4	6,400 *
180					35.9	10,000 *			205	32.4	7,700 *			39.5	7,000 *	45.4	6,400 *
185					33.4	9,100 *			210					37.6	6,900 *	43.4	6,400 *
190					30.7	8,200 *			215					35.6	6,800 *	41.1	6,300 *
									220					33.4	6,700 *		
									225					31.1	6,000 *		

160 ft Boom									160 ft Boom								
Load Radius (ft.)	40' Jib				60' Jib				Load Radius (ft.)	80' Jib				100' Jib			
	10° Offset		30° Offset		10° Offset		30° Offset			10° Offset		30° Offset		10° Offset		30° Offset	
	Boom Angle (deg.)	Rated Load (lbs.)	Boom Angle (deg.)	Rated Load (lbs.)	Boom Angle (deg.)	Rated Load (lbs.)	Boom Angle (deg.)	Rated Load (lbs.)		Boom Angle (deg.)	Rated Load (lbs.)	Boom Angle (deg.)	Rated Load (lbs.)	Boom Angle (deg.)	Rated Load (lbs.)	Boom Angle (deg.)	Rated Load (lbs.)
46	79.7	59,000 *							60	79.3	21,800 *						
48	79.1	59,000 *							65	78.1	21,500 *						
50	78.5	59,000 *							70	76.9	21,200 *						
55	77.1	59,000 *							75	75.6	21,000 *						
60	75.6	55,400	79.1	39,500 *	77.6	41,600 *			80	74.4	20,700 *						
65	74.1	49,600	77.6	38,000 *	76.3	41,200 *			85	73.1	20,500 *	79.1	16,400 *	74.5	12,300 *		
70	72.6	44,700	76.0	36,600 *	74.9	40,600 *	79.8	27,700 *	90	71.9	20,200 *	77.8	16,200 *	73.4	12,000 *		
75	71.1	40,600	74.5	35,400 *	73.6	39,900 *	78.4	26,600 *	95	70.6	19,700 *	76.4	15,900 *	72.2	11,700 *	79.2	8,900 *
80	69.5	37,100	72.9	34,200 *	72.2	37,700	77.0	25,600 *	100	69.3	19,200 *	75.1	15,600 *	71.0	11,300 *	77.9	8,700 *
85	68.0	34,100	71.4	33,100 *	70.8	34,600	75.5	24,800 *	105	68.0	18,800 *	73.8	15,400 *	69.8	11,000 *	76.7	8,500 *
90	66.4	31,400	69.8	32,100 *	69.4	31,900	74.1	23,900 *	110	66.7	18,400 *	72.4	15,200 *	68.7	10,700 *	75.5	8,400 *
95	64.8	29,000	68.1	30,000	68.0	29,500	72.7	23,100 *	115	65.3	17,900 *	71.1	14,900 *	67.4	10,400 *	74.3	8,200 *
100	63.2	26,900	66.5	27,800	66.6	27,400	71.2	22,400 *	120	64.0	17,600 *	69.7	14,700 *	66.2	10,100 *	73.0	8,100 *
105	61.6	25,000	64.8	25,800	65.1	25,500	69.7	21,800 *	125	62.6	17,200 *	68.3	14,500 *	65.0	9,900 *	71.7	7,900 *
110	59.9	23,300	63.1	24,000	63.7	23,800	68.2	21,100 *	130	61.2	16,900 *	66.8	14,100 *	63.7	9,700 *	70.5	7,800 *
115	58.3	21,800	61.4	22,500	62.2	22,300	66.7	20,500 *	135	59.8	16,500 *	65.4	13,800 *	62.5	9,400 *	69.2	7,600 *
120	56.5	20,400	59.6	21,000	60.7	20,900	65.1	20,000 *	140	58.4	16,200 *	63.9	13,400 *	61.2	9,200 *	67.8	7,500 *
125	54.8	19,100	57.8	19,700	59.1	19,600	63.5	19,500 *	145	57.0	15,900 *	62.4	13,100 *	59.9	9,000 *	66.5	7,400 *
130	53.0	17,900	56.0	18,500	57.6	18,400	61.9	19,000 *	150	55.5	15,100	60.8	12,800 *	58.6	8,800 *	65.1	7,300 *
135	51.1	16,900	54.1	17,400	56.0	17,300	60.3	18,400	155	54.0	14,300	59.3	12,500 *	57.3	8,600 *	63.8	7,200 *
140	49.2	15,900	52.1	16,300	54.3	16,300	58.6	17,300	160	52.4	13,600	57.7	12,300 *	55.9	8,400 *	62.4	7,100 *
145	47.2	15,000	50.1	15,400	52.7	15,400	56.9	16,300	165	50.9	12,900	56.0	12,000 *	54.5	8,200 *	60.9	7,000 *
150	45.2	14,100	48.0	14,500	51.0	14,500	55.1	15,400	170	49.2	12,200	54.3	11,800 *	53.1	8,100 *	59.5	6,900 *
155	43.1	13,400	45.8	13,700	49.2	13,800	53.3	14,600	175	47.6	11,600	52.6	11,600 *	51.7	7,900 *	58.0	6,800 *
160	40.9	12,400 *	43.5	12,900	47.4	13,000	51.4	13,800	180	45.9	11,000	50.8	11,400 *	50.2	7,800 *	56.4	6,700 *
165	38.6	11,400 *	41.1	12,000 *	45.6	12,300	49.5	13,000	185	44.1	10,400	48.9	11,000	48.7	7,600 *	54.9	6,700 *
170	36.2	10,400 *			43.6	11,600 *	47.5	12,300	190	42.3	9,800 *	47.0	10,400	47.2	7,500 *	53.2	6,600 *
175	33.6	9,400 *			41.6	10,800 *	45.4	11,700	195	40.4	9,100 *	45.0	9,900	45.6	7,400 *	51.6	6,500 *
180	30.7	8,500 *			39.6	9,900 *	43.1	11,000	200	38.4	8,400 *	42.8	9,300 *	44.0	7,200 *	49.9	6,500 *
185					37.4	9,100 *	40.8	10,300 *	205	36.3	7,700 *	40.6	8,500 *	42.3	7,100 *	48.1	6,400 *
190					35.0	8,300 *			210	34.1	7,000 *			40.5	7,000 *	46.2	6,400 *
195					32.6	7,500 *			215	31.7	6,300 *			38.7	6,900 *	44.3	6,400 *
									220					36.8	6,600 *	42.2	6,300 *
									225					34.8	6,000 *	40.1	6,300 *
									230					32.7	5,400 *		
									235					30.4	4,800 *		

# CK1600-II Jib Rated Loads

with 11 counterweights (116,840 lbs) and 2 carbody weights (22,050 lbs)

Refer to notes page 19

170 ft Boom									170 ft Boom								
Load Radius (ft.)	40' Jib				60' Jib				Load Radius (ft.)	80' Jib				100' Jib			
	10° Offset		30° Offset		10° Offset		30° Offset			10° Offset		30° Offset		10° Offset		30° Offset	
	Boom Angle (deg.)	Rated Load (lbs.)	Boom Angle (deg.)	Rated Load (lbs.)	Boom Angle (deg.)	Rated Load (lbs.)	Boom Angle (deg.)	Rated Load (lbs.)		Boom Angle (deg.)	Rated Load (lbs.)	Boom Angle (deg.)	Rated Load (lbs.)	Boom Angle (deg.)	Rated Load (lbs.)	Boom Angle (deg.)	Rated Load (lbs.)
48	79.6	59,000 *							60	79.8	21,800 *						
50	79.1	59,000 *							65	78.6	21,600 *			79.5	13,100 *		
55	77.7	59,000 *			79.5	42,100 *			70	77.4	21,300 *			78.4	12,900 *		
60	76.3	55,100	79.6	40,000 *	78.2	41,700 *			75	76.2	21,100 *			77.3	12,700 *		
65	74.9	49,300	78.2	38,600 *	76.9	41,400 *			80	75.0	20,800 *			76.2	12,500 *		
70	73.4	44,400	76.7	37,200 *	75.6	40,900 *			85	73.8	20,600 *	79.5	16,500 *	75.1	12,300 *		
75	72.0	40,300	75.3	36,000 *	74.3	40,200 *	78.9	27,000 *	90	72.6	20,400 *	78.3	16,200 *	74.0	12,200 *		
80	70.6	36,800	73.8	34,800 *	73.0	37,400	77.6	26,000 *	95	71.4	20,000 *	77.0	16,000 *	72.9	11,900 *	79.6	8,900 *
85	69.1	33,700	72.3	33,700 *	71.7	34,300	76.2	25,100 *	100	70.2	19,500 *	75.8	15,700 *	71.8	11,500 *	78.4	8,800 *
90	67.6	31,000	70.8	32,100	70.4	31,600	74.9	24,300 *	105	68.9	19,100 *	74.5	15,500 *	70.6	11,200 *	77.3	8,600 *
95	66.1	28,700	69.3	29,700	69.0	29,200	73.5	23,500 *	110	67.7	18,600 *	73.2	15,300 *	69.5	10,900 *	76.1	8,400 *
100	64.6	26,500	67.7	27,500	67.7	27,100	72.1	22,800 *	115	66.4	18,200 *	71.9	15,100 *	68.3	10,600 *	74.9	8,300 *
105	63.1	24,700	66.2	25,500	66.3	25,200	70.7	22,200 *	120	65.1	17,900 *	70.6	14,900 *	67.2	10,300 *	73.7	8,100 *
110	61.5	23,000	64.6	23,800	64.9	23,500	69.3	21,600 *	125	63.8	17,500 *	69.3	14,700 *	66.0	10,100 *	72.5	8,000 *
115	59.9	21,400	63.0	22,200	63.5	21,900	67.8	21,000 *	130	62.5	17,200 *	67.9	14,400 *	64.8	9,800 *	71.3	7,800 *
120	58.3	20,000	61.3	20,700	62.1	20,500	66.4	20,400 *	135	61.2	16,800 *	66.5	14,000 *	63.6	9,600 *	70.0	7,700 *
125	56.7	18,800	59.6	19,400	60.6	19,200	64.9	19,900 *	140	59.9	16,500 *	65.1	13,700 *	62.4	9,400 *	68.8	7,600 *
130	55.0	17,600	57.9	18,200	59.2	18,000	63.4	19,200	145	58.5	15,700	63.7	13,400 *	61.2	9,200 *	67.5	7,500 *
135	53.3	16,500	56.2	17,000	57.7	17,000	61.8	18,100	150	57.1	14,800	62.3	13,100 *	59.9	9,000 *	66.2	7,400 *
140	51.6	15,500	54.4	16,000	56.1	16,000	60.3	17,000	155	55.7	14,000	60.8	12,800 *	58.7	8,800 *	64.9	7,300 *
145	49.8	14,600	52.5	15,100	54.6	15,000	58.7	16,000	160	54.2	13,200	59.3	12,500 *	57.4	8,600 *	63.6	7,200 *
150	47.9	13,800	50.6	14,200	53.0	14,200	57.0	15,100	165	52.8	12,500	57.8	12,300 *	56.1	8,400 *	62.3	7,100 *
155	46.0	13,000	48.7	13,300	51.4	13,400	55.4	14,300	170	51.3	11,900	56.2	12,000 *	54.7	8,200 *	60.9	7,000 *
160	44.0	12,200 *	46.6	12,600	49.7	12,600	53.6	13,500	175	49.7	11,200	54.6	11,800 *	53.4	8,100 *	59.5	6,900 *
165	42.0	11,200 *	44.5	11,800 *	48.0	11,900	51.9	12,700	180	48.1	10,700	53.0	11,300	52.0	7,900 *	58.1	6,800 *
170	39.8	10,300 *	42.3	10,900 *	46.3	11,300 *	50.0	12,000	185	46.5	10,100	51.3	10,700	50.6	7,800 *	56.6	6,700 *
175	37.6	9,400 *			44.5	10,500 *	48.1	11,400	190	44.8	9,500 *	49.5	10,200	49.2	7,600 *	55.1	6,700 *
180	35.2	8,500 *			42.6	9,700 *	46.2	10,800	195	43.1	8,800 *	47.7	9,600	47.7	7,500 *	53.6	6,600 *
185	32.7	7,700 *			40.6	8,900 *	44.1	10,200	200	41.3	8,200 *	45.8	9,100 *	46.2	7,400 *	52.0	6,500 *
190	30.0	6,800 *			38.6	8,200 *	42.0	9,300 *	205	39.5	7,500 *	43.8	8,400 *	44.7	7,300 *	50.3	6,500 *
195					36.5	7,500 *			210	37.5	6,900 *	41.7	7,700 *	43.1	7,200 *	48.7	6,400 *
200					34.2	6,800 *			215	35.5	6,200 *			41.4	6,900 *	46.9	6,400 *
205					31.8	6,000 *			220	33.3	5,600 *			39.7	6,400 *	45.1	6,400 *
									225	31.0	4,900 *			37.9	5,800 *	43.2	6,300 *
									230					36.0	5,300 *	41.2	6,300 *
									235					34.1	4,700 *		
									240					32.0	4,200 *		

180 ft Boom									180 ft Boom								
Load Radius (ft.)	40' Jib				60' Jib				Load Radius (ft.)	80' Jib				100' Jib			
	10° Offset		30° Offset		10° Offset		30° Offset			10° Offset		30° Offset		10° Offset		30° Offset	
	Boom Angle (deg.)	Rated Load (lbs.)	Boom Angle (deg.)	Rated Load (lbs.)	Boom Angle (deg.)	Rated Load (lbs.)	Boom Angle (deg.)	Rated Load (lbs.)		Boom Angle (deg.)	Rated Load (lbs.)	Boom Angle (deg.)	Rated Load (lbs.)	Boom Angle (deg.)	Rated Load (lbs.)	Boom Angle (deg.)	Rated Load (lbs.)
50	79.6	59,000 *			79.9	42,300 *			65	79.1	21,600 *			79.9	13,200 *		
55	78.3	59,000 *			78.7	41,900 *			70	77.9	21,400 *			78.8	13,000 *		
60	76.9	54,700			77.5	41,500 *			75	76.8	21,200 *			77.8	12,800 *		
65	75.6	48,800	78.8	39,100 *	76.2	41,200 *			80	75.6	20,900 *			76.7	12,600 *		
70	74.2	44,000	77.4	37,700 *	75.0	40,500 *	79.4	27,400 *	85	74.5	20,700 *	80.0	16,600 *	75.7	12,400 *		
75	72.9	39,900	76.0	36,500 *	73.7	37,000	78.1	26,400 *	90	73.3	20,500 *	78.8	16,300 *	74.6	12,200 *		
80	71.5	36,300	74.6	35,400 *	72.5	33,900	76.8	25,500 *	95	72.2	20,300 *	77.6	16,100 *	73.5	12,000 *	80.0	9,000 *
85	70.1	33,300	73.2	34,300 *	71.2	31,200	75.5	24,700 *	100	71.0	19,800 *	76.4	15,800 *	72.4	11,700 *	78.9	8,800 *
90	68.7	30,600	71.8	31,800	70.0	28,800	74.2	23,900 *	105	69.8	19,400 *	75.2	15,600 *	71.4	11,400 *	77.8	8,700 *
95	67.3	28,200	70.3	29,300	68.6	26,600	72.9	23,200 *	110	68.6	18,900 *	73.9	15,400 *	70.3	11,100 *	76.6	8,500 *
100	65.9	26,100	68.9	27,100	67.3	24,800	71.6	22,600 *	115	67.4	18,500 *	72.7	15,200 *	69.2	10,800 *	75.5	8,300 *
105	64.4	24,200	67.4	25,100	66.0	23,000	70.2	22,000 *	120	66.2	18,200 *	71.4	15,000 *	68.0	10,500 *	74.4	8,200 *
110	62.9	22,500	65.9	23,400	64.7	21,500	68.9	21,400 *	125	64.9	17,800 *	70.2	14,800 *	66.9	10,300 *	73.2	8,000 *
115	61.5	21,000	64.4	21,800	63.3	20,100	67.5	20,800 *	130	63.7	17,500 *	68.9	14,600 *	65.8	10,000 *	72.0	7,900 *
120	59.9	19,600	62.8	20,300	62.0	18,800	66.1	20,100	135	62.4	17,100 *	67.6	14,300 *	64.6	9,800 *	70.9	7,800 *
125	58.4	18,300	61.3	19,000	60.6	17,600	64.7	18,900	140	61.1	16,200	66.3	13,900 *	63.5	9,600 *	69.7	7,700 *
130	56.8	17,100	59.7	17,800	60.6	17,600	63.2	17,700	145	59.9	15,200	64.9	13,600 *	62.3	9,300 *	68.5	7,600 *
135	55.3	16,000	58.0	16,600	59.2	16,500	61.7	16,700	150	58.5	14,400	63.6	13,300 *	61.1	9,100 *	67.2	7,400 *
140	53.6	15,100	56.4	15,600	57.8	15,500	60.2	15,700	155	57.2	13,600	62.2	13,000 *	59.9	8,900 *	66.0	7,300 *
145	52.0	14,100	54.7	14,600	56.3	14,600	58.7	14,800	160	55.8	12,800	60.8	12,800 *	58.7	8,800 *	64.7	7,200 *
150	50.3	13,300	52.9	13,800	54.8	13,700	57.2	14,900	165	54.5	12,100	59.3	12,500 *	57.5	8,600 *	63.5	7,100 *
155	48.5	12,500	51.1	12,900	53.3	12,900	55.7	13,500	170	53.1	11,400	57.9	12,300	56.2	8,400 *	62.2	7,000 *
160	46.7	11,600 *	49.3	12,100	51.8	12,200	55.6	13,100	175	51.6	10,800	56.4	11,600	54.9	8,300 *	60.8	7,000 *
165	44.9	10,800 *	47.3	11,300 *	50.2	11,500	53.9	12,300	180	50.1	10,200	54.9	11,000	53.6	8,100 *	59.5	6,900 *
170	42.9	9,900 *	45.3	10,500 *	48.6	10,700 *	52.3	11,700	185	48.6	9,700	53.3	10,400	52.3	8,000 *	58.1	6,800 *
175	40.9	9,100 *	43.3	9,600 *	46.9	9,900 *	50.5	11,000	190	47.1	9,000 *	51.7	9,800	51.0	7,800 *	56.7	6,700 *
180	38.9	8,200 *	41.1	8,800 *	45.2	9,200 *	48.7	10,400	195	45.5	8,300 *	50.0	9,300	49.6	7,700 *	55.3	6,700 *
185	36.7	7,400 *			43.4	8,500 *	46.9	9,700 *	200	43.9	7,700 *	48.3	8,600 *	48.2	7,500 *	53.8	6,600 *
190	34.4	6,700 *			41.6	7,800 *	45.0	9,000 *	205	42.2	7,100 *	46.5	8,000 *	46.8	7,400 *	52.3	6,500 *
195	31.9	5,900 *			39.7	7,100 *	43.0	8,200 *	210	40.4	6,500 *	44.6	7,400 *	45.3	7,000 *	50.8	6,500 *
200					37.7	6,400 *	40.9	7,500 *	215	38.6	5,900 *	42.7	6,700 *	43.8	6,500 *	49.2	6,500 *
205					35.6	5,800 *			220	36.7	5,300 *	40.6	6,100 *	42.2	5,900 *	47.5	6,400 *
210					33.4	5,100 *			225	34.7	4,700 *			40.6			

# CK1600-II Jib Rated Loads

with 11 counterweights (116,840 lbs) and 2 carbody weights (22,050 lbs)

Refer to notes page 19

190 ft Boom									190 ft Boom								
Load Radius (ft.)	40' Jib				60' Jib				Load Radius (ft.)	80' Jib				100' Jib			
	10° Offset		30° Offset		10° Offset		30° Offset			10° Offset		30° Offset		10° Offset		30° Offset	
	Boom Angle (deg.)	Rated Load (lbs.)	Boom Angle (deg.)	Rated Load (lbs.)	Boom Angle (deg.)	Rated Load (lbs.)	Boom Angle (deg.)	Rated Load (lbs.)		Boom Angle (deg.)	Rated Load (lbs.)	Boom Angle (deg.)	Rated Load (lbs.)	Boom Angle (deg.)	Rated Load (lbs.)	Boom Angle (deg.)	Rated Load (lbs.)
50	80.0	53,100 *							65	79.5	21,700 *						
55	78.8	52,400 *							70	78.4	21,500 *			79.2	13,000 *		
60	77.5	51,600 *							75	77.3	21,200 *			78.2	12,800 *		
65	76.2	48,300 *	79.3	39,600 *	78.0	41,600 *			80	76.2	21,000 *			77.2	12,600 *		
70	74.9	43,600 *	78.0	38,200 *	76.8	41,300 *			85	75.1	20,800 *			76.2	12,500 *		
75	73.6	39,500 *	76.6	37,000 *	75.6	40,000 *	79.9	27,700 *	90	74.0	20,600 *	79.2	16,400 *	75.2	12,300 *		
80	72.3	36,000 *	75.3	35,900 *	74.4	36,600 *	78.6	26,800 *	95	72.8	20,400 *	78.1	16,200 *	74.1	12,100 *		
85	71.0	32,900 *	74.0	34,300 *	73.2	33,500 *	77.4	25,900 *	100	71.7	20,100 *	76.9	15,900 *	73.1	11,900 *	79.3	8,900 *
90	69.7	30,200 *	72.6	31,500 *	72.0	30,800 *	76.2	25,100 *	105	70.6	19,600 *	75.8	15,700 *	72.0	11,600 *	78.2	8,700 *
95	68.3	27,800 *	71.2	29,000 *	70.8	28,400 *	74.9	24,300 *	110	69.4	19,200 *	74.6	15,500 *	71.0	11,300 *	77.1	8,500 *
100	67.0	25,700 *	69.9	26,800 *	69.5	26,300 *	73.7	23,600 *	115	68.3	18,800 *	73.4	15,300 *	69.9	11,000 *	76.1	8,400 *
105	65.6	23,800 *	68.5	24,800 *	68.3	24,400 *	72.4	22,900 *	120	67.1	18,400 *	72.2	15,100 *	68.8	10,700 *	75.0	8,200 *
110	64.2	22,100 *	67.1	23,100 *	67.1	22,700 *	71.1	22,300 *	125	65.9	18,100 *	71.0	14,900 *	67.8	10,400 *	73.8	8,100 *
115	62.8	20,600 *	65.6	21,400 *	65.8	21,100 *	69.8	21,700 *	130	64.8	17,700 *	69.8	14,700 *	66.7	10,200 *	72.7	8,000 *
120	61.4	19,200 *	64.2	20,000 *	64.5	19,700 *	68.5	21,200 *	135	63.6	16,900 *	68.5	14,500 *	65.6	10,000 *	71.6	7,800 *
125	59.9	17,900 *	62.7	18,600 *	63.2	18,400 *	67.2	19,900 *	140	62.3	15,800 *	67.3	14,200 *	64.5	9,700 *	70.5	7,700 *
130	58.5	16,700 *	61.2	17,400 *	61.9	17,200 *	65.8	18,600 *	145	61.1	14,900 *	66.0	13,800 *	63.4	9,500 *	69.3	7,600 *
135	57.0	15,700 *	59.7	16,300 *	60.6	16,100 *	64.5	17,400 *	150	59.9	14,000 *	64.7	13,600 *	62.2	9,300 *	68.1	7,500 *
140	55.5	14,700 *	58.1	15,200 *	59.2	15,100 *	63.1	16,400 *	155	58.6	13,200 *	63.4	13,300 *	61.1	9,100 *	67.0	7,400 *
145	53.9	13,800 *	56.5	14,300 *	57.9	14,200 *	61.7	15,400 *	160	57.3	12,500 *	62.1	13,000 *	59.9	8,900 *	65.8	7,300 *
150	52.3	12,900 *	54.9	13,400 *	56.5	13,300 *	60.2	14,500 *	165	56.0	11,700 *	60.7	12,700 *	58.7	8,700 *	64.6	7,200 *
155	50.7	12,100 *	53.3	12,600 *	55.0	12,500 *	58.8	13,600 *	170	54.7	11,100 *	59.4	12,000 *	57.6	8,600 *	63.3	7,100 *
160	49.1	11,200 *	51.6	11,800 *	53.6	11,800 *	57.3	12,800 *	175	53.3	10,400 *	58.0	11,300 *	56.4	8,400 *	62.1	7,000 *
165	47.4	10,300 *	49.8	10,900 *	52.1	11,000 *	55.8	12,000 *	180	52.0	9,800 *	56.5	10,700 *	55.1	8,300 *	60.8	6,900 *
170	45.6	9,500 *	48.0	10,100 *	50.6	10,200 *	54.2	11,300 *	185	50.6	9,200 *	55.1	10,100 *	53.9	8,100 *	59.5	6,900 *
175	43.8	8,700 *	46.1	9,300 *	49.1	9,500 *	52.6	10,700 *	190	49.1	8,500 *	53.6	9,500 *	52.6	8,000 *	58.2	6,800 *
180	41.9	8,000 *	44.2	8,500 *	47.5	8,800 *	51.0	10,000 *	195	47.6	7,900 *	52.0	8,900 *	51.3	7,800 *	56.9	6,700 *
185	40.0	7,200 *	42.2	7,700 *	45.9	8,100 *	49.3	9,400 *	200	46.1	7,300 *	50.5	8,300 *	50.0	7,700 *	55.5	6,700 *
190	37.9	6,500 *	40.0	7,000 *	44.2	7,400 *	47.6	8,700 *	205	44.6	6,700 *	48.8	7,600 *	48.7	7,100 *	54.1	6,600 *
195	35.8	5,700 *			42.5	6,800 *	45.7	8,000 *	210	43.0	6,100 *	47.1	7,000 *	47.3	6,600 *	52.7	6,500 *
200	33.6	5,000 *			40.7	6,100 *	43.9	7,300 *	215	41.3	5,600 *	45.4	6,400 *	45.9	6,100 *	51.2	6,500 *
205	31.1	4,300 *			38.8	5,500 *	41.9	6,600 *	220	39.6	5,000 *	43.6	5,900 *	44.4	5,500 *	49.7	6,500 *
210					36.9	4,900 *			225	37.8	4,500 *	41.7	5,300 *	42.9	5,000 *	48.1	6,100 *
215					34.9	4,300 *			230					41.4	4,600 *	46.5	5,600 *
									235					39.8	4,100 *	44.8	5,100 *
									240							43.0	4,600 *
									245							41.2	4,100 *

200 ft Boom									200 ft Boom								
Load Radius (ft.)	40' Jib				60' Jib				Load Radius (ft.)	80' Jib				100' Jib			
	10° Offset		30° Offset		10° Offset		30° Offset			10° Offset		30° Offset		10° Offset		30° Offset	
	Boom Angle (deg.)	Rated Load (lbs.)	Boom Angle (deg.)	Rated Load (lbs.)	Boom Angle (deg.)	Rated Load (lbs.)	Boom Angle (deg.)	Rated Load (lbs.)		Boom Angle (deg.)	Rated Load (lbs.)	Boom Angle (deg.)	Rated Load (lbs.)	Boom Angle (deg.)	Rated Load (lbs.)	Boom Angle (deg.)	Rated Load (lbs.)
55	79.2	46,200 *							65	79.8	21,800 *						
60	78.0	45,500 *							70	78.8	21,600 *			79.6	13,100 *		
65	76.8	44,700 *	79.7	40,000 *	78.4	41,700 *			75	77.7	21,300 *			78.6	12,900 *		
70	75.6	42,900 *	78.5	38,700 *	77.3	41,400 *			80	76.7	21,100 *			77.6	12,700 *		
75	74.3	39,100 *	77.2	37,500 *	76.2	39,200 *			85	75.6	20,900 *			76.7	12,500 *		
80	73.1	35,700 *	76.0	36,400 *	75.0	35,900 *	79.1	27,100 *	90	74.6	20,700 *	79.6	16,500 *	75.7	12,400 *		
85	71.8	32,600 *	74.7	33,800 *	73.9	33,000 *	77.9	26,200 *	95	73.5	20,500 *	78.5	16,200 *	74.7	12,200 *		
90	70.6	30,000 *	73.4	31,100 *	72.7	30,400 *	76.7	25,400 *	100	72.4	20,300 *	77.4	16,000 *	73.7	12,100 *	79.7	8,900 *
95	69.3	27,600 *	72.1	28,800 *	71.6	28,100 *	75.5	24,700 *	105	71.3	19,900 *	76.3	15,800 *	72.7	11,700 *	78.6	8,700 *
100	68.0	25,500 *	70.8	26,600 *	70.4	26,000 *	74.3	24,000 *	110	70.2	19,500 *	75.2	15,600 *	71.6	11,400 *	77.6	8,600 *
105	66.7	23,600 *	69.5	24,600 *	69.2	24,100 *	73.1	23,300 *	115	69.1	19,100 *	74.0	15,400 *	70.6	11,100 *	76.6	8,400 *
110	65.4	21,800 *	68.1	22,800 *	68.0	22,400 *	71.9	22,700 *	120	68.0	18,700 *	72.9	15,200 *	69.6	10,900 *	75.5	8,300 *
115	64.0	20,300 *	66.8	21,200 *	66.8	20,800 *	70.7	22,100 *	125	66.9	18,300 *	71.7	15,000 *	68.6	10,600 *	74.4	8,200 *
120	62.7	18,900 *	65.4	19,700 *	65.6	19,400 *	69.4	21,000 *	130	65.7	17,700 *	70.6	14,800 *	67.5	10,400 *	73.4	8,000 *
125	61.3	17,600 *	64.0	18,400 *	64.3	18,100 *	68.2	19,600 *	135	64.6	16,600 *	69.4	14,600 *	66.5	10,100 *	72.3	7,900 *
130	60.0	16,400 *	62.6	17,200 *	63.1	16,900 *	66.9	18,400 *	140	63.4	15,600 *	68.2	14,400 *	65.4	9,900 *	71.2	7,800 *
135	58.5	15,400 *	61.1	16,000 *	61.8	15,800 *	65.6	17,200 *	145	62.3	14,600 *	67.0	14,100 *	64.3	9,700 *	70.1	7,700 *
140	57.1	14,400 *	59.7	15,000 *	60.5	14,800 *	64.3	16,100 *	150	61.1	13,800 *	65.8	13,800 *	63.2	9,500 *	69.0	7,600 *
145	55.7	13,400 *	58.2	14,000 *	59.3	13,900 *	63.0	15,100 *	155	59.9	12,900 *	64.5	13,500 *	62.2	9,300 *	67.9	7,500 *
150	54.2	12,500 *	56.7	13,100 *	57.9	13,000 *	61.6	14,200 *	160	58.6	12,200 *	63.3	13,200 *	61.0	9,100 *	66.7	7,400 *
155	52.7	11,600 *	55.2	12,300 *	56.6	12,100 *	60.2	13,400 *	165	57.4	11,500 *	62.0	12,500 *	59.9	8,900 *	65.6	7,300 *
160	51.1	10,800 *	53.6	11,400 *	55.2	11,300 *	58.8	12,600 *	170	56.2	10,800 *	60.7	11,700 *	58.8	8,700 *	64.4	7,200 *
165	49.6	9,900 *	52.0	10,600 *	53.9	10,500 *	57.4	11,800 *	175	54.9	10,100 *	59.4	11,100 *	57.6	8,600 *	63.2	7,100 *
170	48.0	9,100 *	50.3	9,700 *	52.5	9,800 *	56.0	11,100 *	180	53.6	9,400 *	58.1	10,400 *	56.5	8,400 *	62.0	7,000 *
175	46.3	8,400 *	48.6	9,000 *	51.0	9,100 *	54.5	10,400 *	185	52.3	8,800 *	56.7	9,800 *	55.3	8,300 *	60.8	6,900 *
180	44.6	7,700 *	46.8	8,200 *	49.6	8,400 *	53.0	9,700 *	190	50.9	8,100 *	55.3	9,200 *	54.1	8,100 *	59.5	6,900 *
185	42.8	6,900 *	45.0	7,500 *	48.1	7,700 *	51.4	9,000 *	195	49.5	7,500 *	53.9	8,500 *	52.9	7,800 *	58.3	6,800 *
190	41.0	6,300 *	43.1	6,800 *	46.5	7,000 *	49.8	8,300 *	200	48.1	6,900 *	52.4	7,900 *	51.6	7,200 *	57.0	6,700 *
195	39.1	5,600 *	41.1	6,100 *	44.9	6,400 *	48.1	7,700 *	205	46.7	6,400 *	50.9	7,300 *	50.4	6,700 *	55.7	6,700 *
200	37.1	4,900 *			43.3	5,800 *	46.4	7,000 *	210	45.2	5,800 *	49.3	6,700 *	49.1	6,200 *	54.3	6,600 *
205	35.0	4,200 *			41.6	5,200 *	44.7	6,400 *	215	43.7	5,300 *	47.7	6,200 *	47.8	5,700 *	53.0	6,500 *
210					39.9	4,700 *	42.8	5,700 *	220	42.1	4,700 *	46.1	5,600 *	46.4	5,200 *	51.5	6,300 *



# CK1600-II

**WMAK**  
SALE & RENTAL

*Note: Due to our policy of continual product improvement, all designs and specifications are subject to change without advance notice. Pictures inside this publication may show machines with optional equipment. This manual and the specifications herein were prepared for the market served by Kobelco Cranes North America Inc., including North America and Latin America. Kobelco product specifications in other world markets may differ.*

KOBELCO CRANES CO., LTD  
Oval Court Ohsaki Mark West Bldg., 17-1, Higashigotanda 2-chome,  
Shinagawa-ku, Tokyo, 141-8626 JAPAN  
Tel: +81 (0) 3-5789-2130 Fax: +81 (0) 3-5789-3372

KOBELCO CRANES NORTH AMERICA INC.  
10845 Train Court  
Houston Texas 77041 U.S.A  
Tel: 713-856-5755 Fax: 713-856-9072  
[www.kobelcocranesnorthamerica.com](http://www.kobelcocranesnorthamerica.com)