

HEAVY DUTY BASE MACHINE FOR FOUNDATION WORK

KOBELCO

BM700HD-2

Max. Lifting Capacity: 70 t
Max. Boom Length: 54.9 m
Max. Jib Combination: 42.7 + 11.8.3 m

BM800HD-2

Max. Lifting Capacity: 80 t
Max. Boom Length: 54.9 m

S P E C I F I C A T I O N S

Crane Boom	BM700HD-2	BM800HD-2
Max. Lifting Capacity	70 t/3.7 m	80 t/3.7 m
Max. Length	54.9 m	54.9 m
Crane Jib		
Max. Lifting Capacity	6.6 t	NA
Max. Length	18.3 m	NA
Max. Combination	42.7 m+18.3 m	NA
Main & Aux. Winch		
Max. Line Speed	120 m/min (1st layer)	
Rated Line Pull	108 kN (11 tf)	
Max. Line Pull *	196 kN (20 tf)	
Wire Rope	26 mm	
Wire Rope Length	170m (Main) 125m (Aux.)	170m (Main) 125m (Aux.)
Brake Type	Wet-type multiple - disc brake	
Free-Fall	Standard	
Working Speed		
Swing Speed	4.0 min ⁻¹ (rpm)	
Travel Speed	1.9/1.2 km/h	

Power Plant	BM700HD-2	BM800HD-2
Model	Mitsubishi 6D24-TLE2A	
Engine Output	235 kW/2,000 min ⁻¹ (rpm)	
Fuel Tank Capacity	400 liters	
Hydraulic System		
Main Pumps	3 variable displacement	
Max. Pressure	30.9 MPa (315 kgf/cm ²)	
Hydraulic Tank Capacity	380 liters	
Weight		
Operating Weight	Approx. 69 t	Approx. 75 t
Counterweight	22.9 t	25.9 t
Transport Weight	43.9 t	44.2 t
	(Main machine with crawler and lower boom)	
Ground Pressure	77 kPa (0.80 kgf/cm ²)	82 kPa (0.84 kgf/cm ²)

*) Max. Line Pull is theoretical values and for reference only.

GENERAL DIMENSIONS

Unit: mm

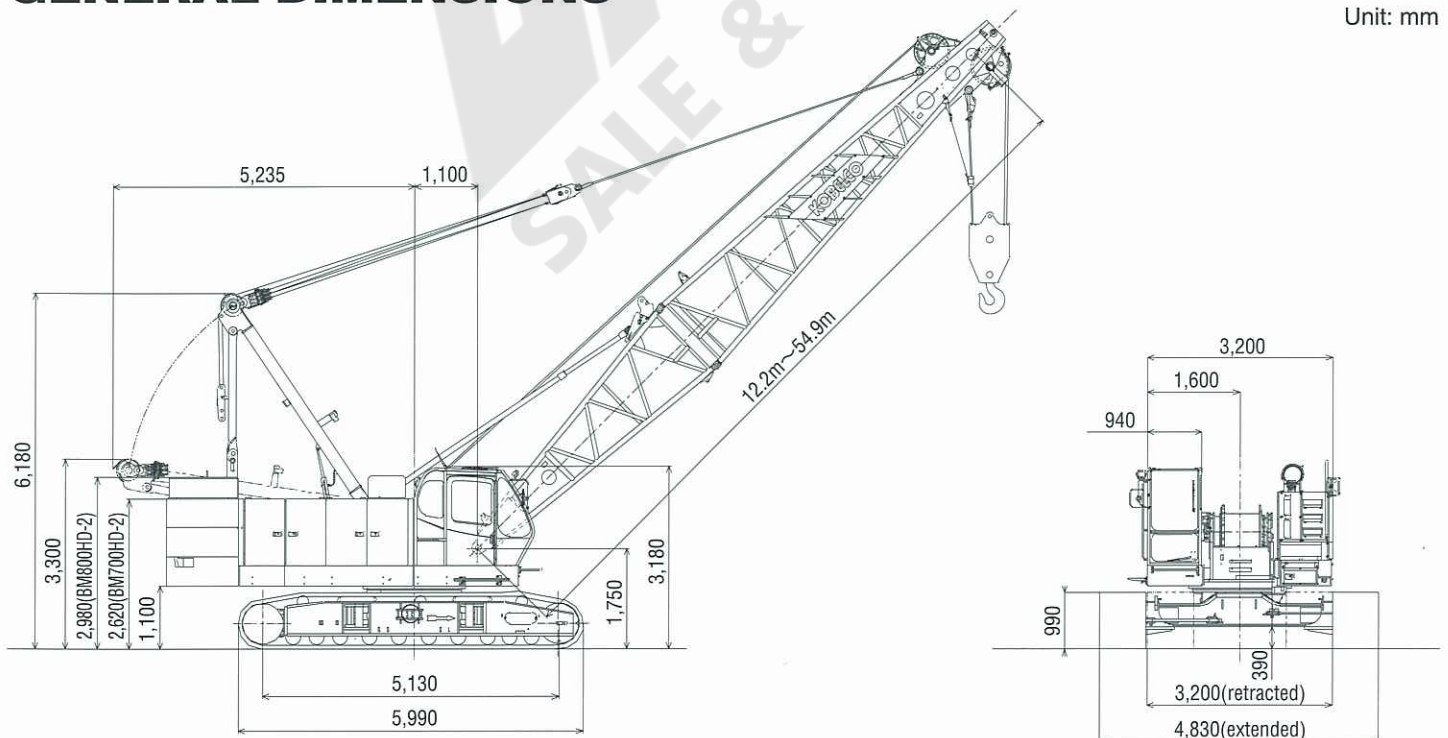

KOBELCO CRANES CO., LTD.

SPECIFICATIONS OF PARTS AND ATTACHMENTS

Base Machine + Boom Base + Crawler

weight: 44,200 kg
Dimensions: 3,300 mm height x 3,200 mm width x 11,690 mm length

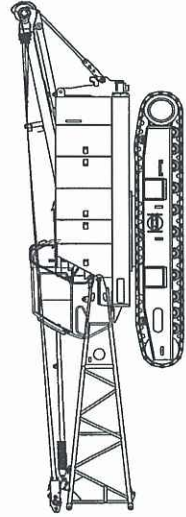

Counterweight

No.1 Counterweight
weight: 7,650 kg

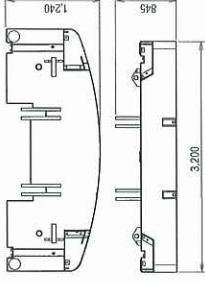

Base Machine + Crawler

weight: 42,600 kg
Dimensions: 3,300 mm height x 3,200 mm width x 8,170 mm length

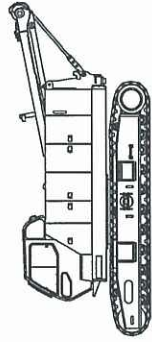

No.2 Counterweight
weight: 7,560 kg

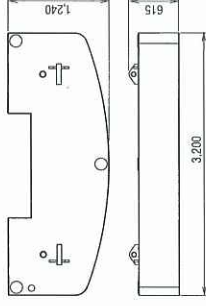

Upper Boom

weight: 1,340 kg

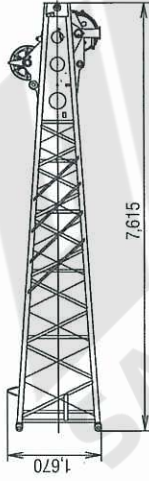
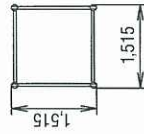

Lower Boom

weight: 1,130 kg

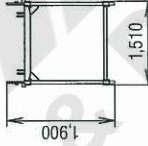
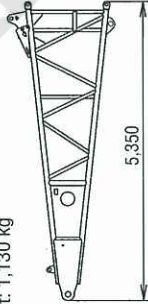

No.4, No.5 Counterweight (BM800HD-2 only)

weight: 1,500 kg (1 pc)

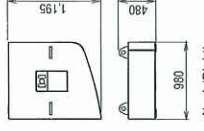
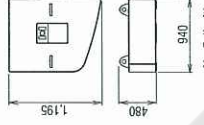

OTHER ATTACHMENTS

Attachment	Weight	Dimensions (L x W x H)
3.1 m (10 ft) insert boom	310 kg	3,160 mm x 1,510 mm x 1,515 mm
6.1 m (20 ft) insert boom	522 kg	6,210 mm x 1,510 mm x 1,515 mm
6.1 m (20 ft) insert boom with lug	545 kg	6,210 mm x 1,510 mm x 1,645 mm
9.1 m (30 ft) insert boom	742 kg	9,260 mm x 1,510 mm x 1,515 mm
9.1 m (30 ft) insert boom with lug	765 kg	9,260 mm x 1,510 mm x 1,645 mm
Jib tip *	180 kg	3,475 mm x 675 mm x 625 mm
Jib base *	125 kg	3,190 mm x 675 mm x 625 mm
6.1 m (20 ft) insert Jib *	140 kg	6,160 mm x 675 mm x 625 mm
Jib Strut *	220 kg	3,700 mm x 670 mm x 500 mm
Auxiliary sheave	138 kg	1,010 mm x 1,310 mm
Upper spreader	280 kg	1,580 mm x 300 mm x 680 mm
Lower spreader	170 kg	870 mm x 300 mm x 610 mm
80-ton hook block **	950 kg	700 mm x 452 mm x 1,825 mm
70-ton hook block *	900 kg	700 mm x 370 mm x 1,780 mm
50-ton hook block	700 kg	700 mm x 370 mm x 1,696 mm
32-ton hook block	660 kg	700 mm x 364 mm x 1,570 mm
11-ton ball hook	300 kg	∅ 357 mm x 1,050 mm
11-ton ball hook (light weight type)	100 kg	∅ 300 mm x 815 mm

* BM700HD-2 use only
** BM800HD-2 use only

Note: Due to our policy of continual product improvements all designs and specifications are subject to change without advance notice. KOBELCO is the corporate mark used by Kobe Steel on a variety of products and in the names of a number of Kobe Steel Group companies.

KOBELCO CRANES CO., LTD.

17-1, Higashigotanda 2-chome, Shinagawa-ku, TOKYO, 141-8626 JAPAN
Tel: +81-3-5789-2130 Fax: +81-3-5789-3372