

KOBELCO

HYDRAULIC CRAWLER CRANE **7090**

Model: 7090-1F

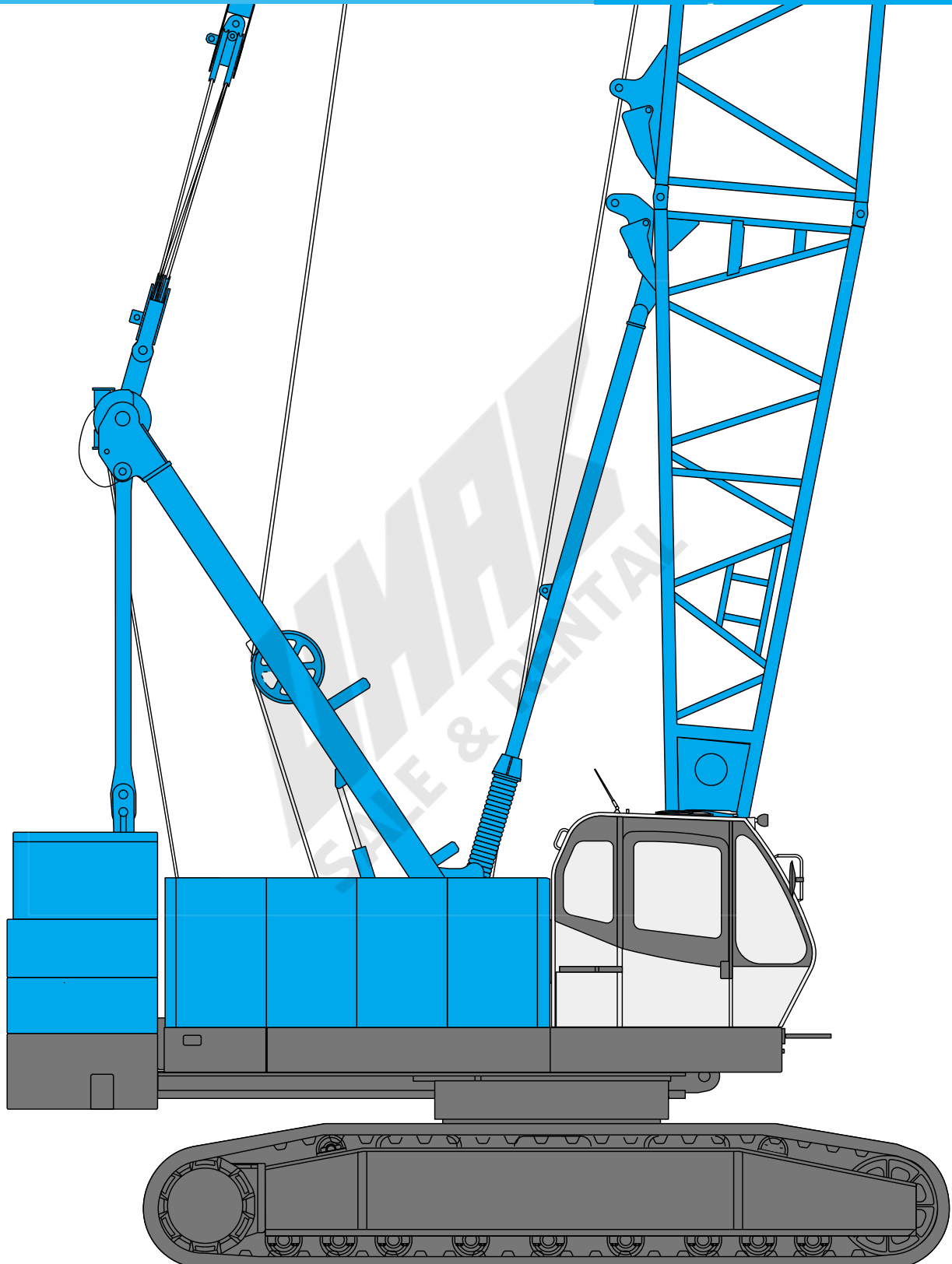

Max. Lifting Capacity: 90 t x 4.3 m
Max. Crane Boom Length: 62.6 m
Max. Fixed Jib Combination: 53.4 + 21.3 m
Max. Tower Jib Combination: 44.3 + 37.1 m

CONFIGURATION

Crane Boom

Max. Lifting Capacity:
90 metric ton x 4.3 m
Max. Boom Length:
62.6 m



Fixed Jib

Max. Lifting Capacity:
11 metric ton x 18.0 m
Max. Combination:
53.4 m + 21.3 m

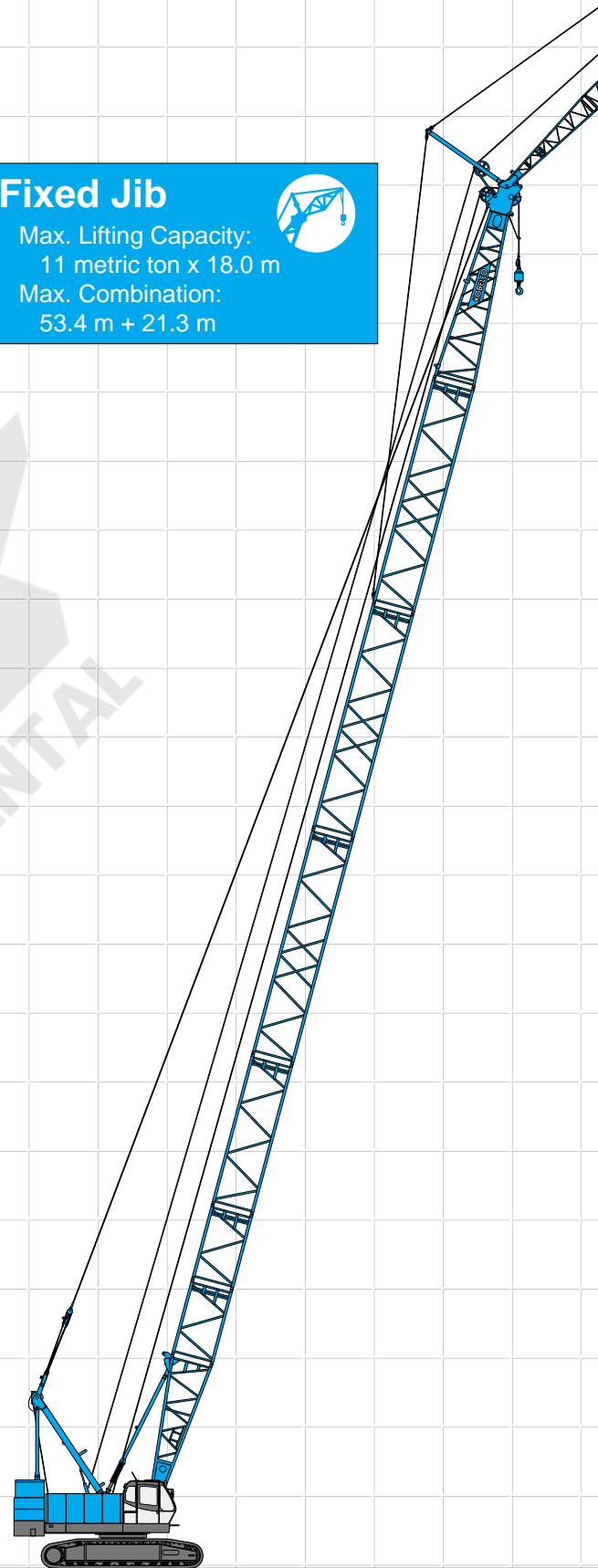
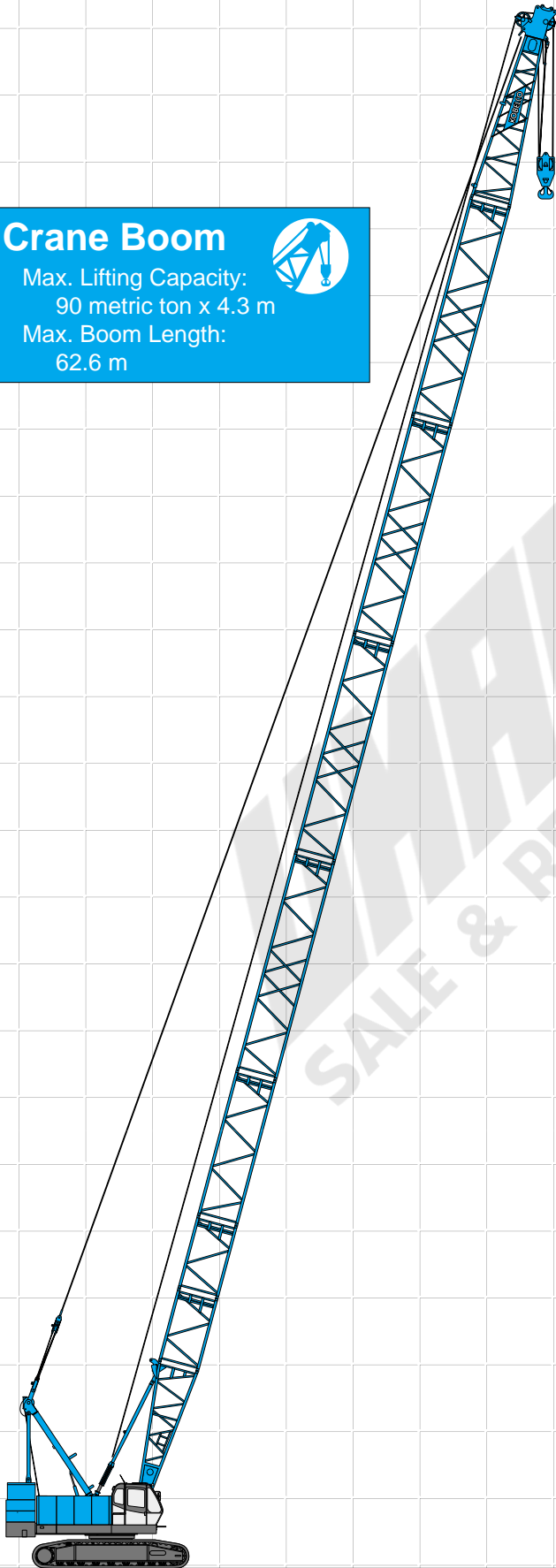

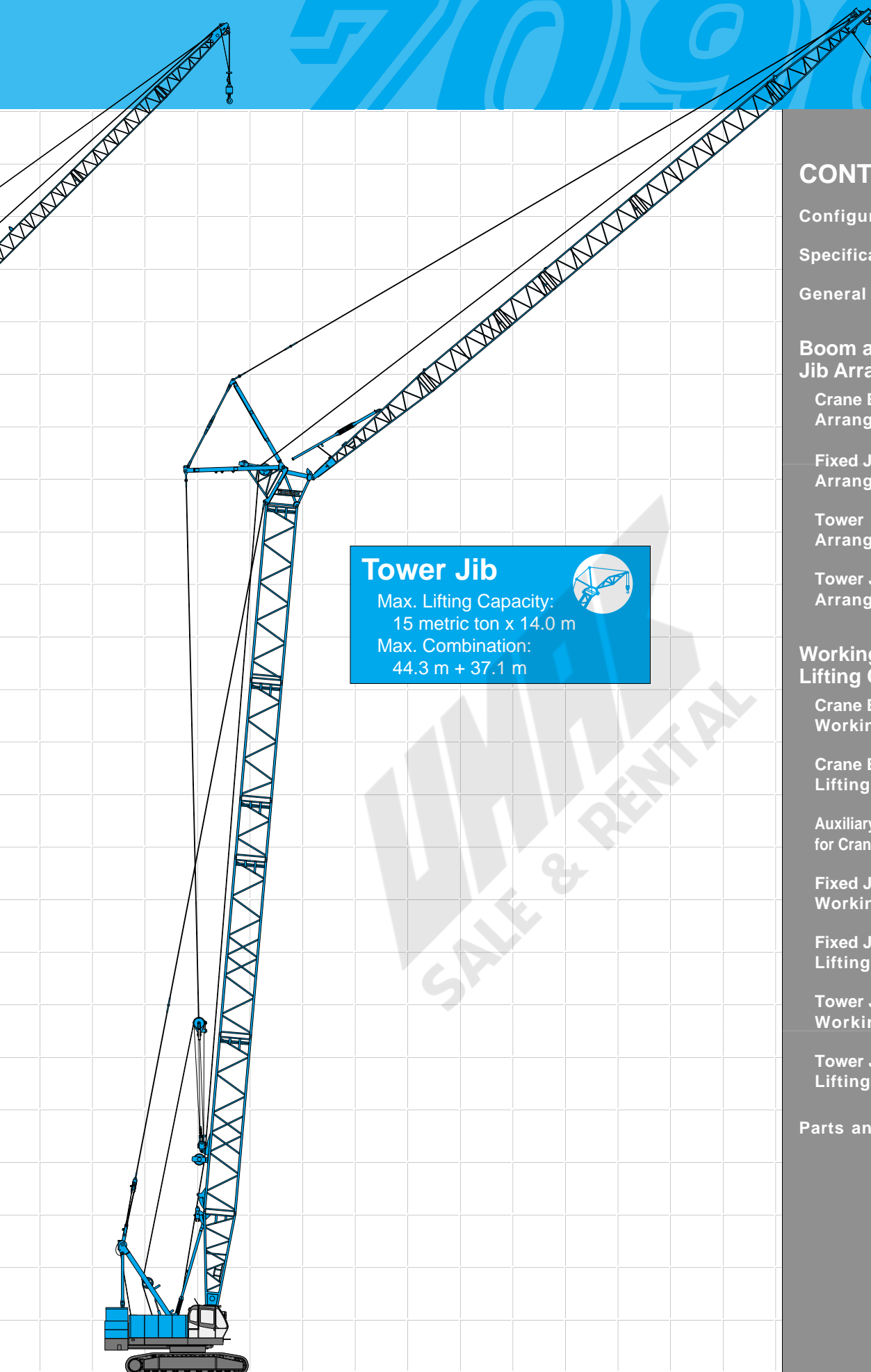

Tower Jib
Max. Lifting Capacity:
15 metric ton x 14.0 m
Max. Combination:
44.3 m + 37.1 m



SALE & RENTAL

CONTENTS

- Configuration 1
- Specifications 3
- General Dimensions 5
- Boom and Jib Arrangements**
 - Crane Boom Arrangements 7
 - Fixed Jib Arrangements 8
 - Tower Arrangements 9
 - Tower Jib Arrangements 9
- Working Ranges and Lifting Capacities**
 - Crane Boom Working Ranges 10
 - Crane Boom Lifting Capacity 11
 - Auxiliary Sheave Lifting Capacity for Crane Boom 12
 - Fixed Jib Working Ranges 13
 - Fixed Jib Lifting Capacities 14
 - Tower Jib Working Ranges 17
 - Tower Jib Lifting Capacities 19
- Parts and Attachments ... 25

SPECIFICATIONS



Power Plant

Model: Hino diesel engine P11C-UN
Type: Water-cooled, direct fuel injection, with turbocharger
Complies with NRMM (Europe) Stage IIIA and US EPA Tier III.
Displacement: 10.520 liters
Rated Power: 247 kW at 2,000 min⁻¹ {rpm} (ISO)
Max. torque: 1,300 N·m/1,500 min⁻¹
Cooling system: Liquid, recirculating bypass
Starter: 24 V/6.0 kW
Radiator: Corrugated type core, thermostatically controlled
Air cleaner: Dry type with replaceable paper element
Throttle: Electric throttle control, twist grip type
Fuel filter: Replaceable paper element
Batteries: Two 12V, 136Ah/5HR capacity batteries, series connected.
Fuel tank capacity: 400 liters



Hydraulic System

Four variable displacement piston pumps are driven by heavy-duty pump drive. Two of variable displacement pumps are used in the main hook hoist circuit, auxiliary hook hoist circuit and each propel circuit. One of the other two pumps is used in the swing circuit. The other is used in the boom hoist circuit and third hoist circuit.

Control: Full-flow hydraulic control system for infinitely variable pressure to front and rear drums, boom hoist brakes and clutches. Controls respond instantly to the touch, delivering smooth function operation.

Cooling: Oil-to-air heat exchanger (plate-fin type)

Filtration: Full-flow and bypass type with replaceable element

Electrical system: All wiring corded for easy servicing, individual fused branch circuits.

Max. relief valve pressure:

Load hoist, boom hoist and propel system:

31.9 MPa {325 kgf/cm²}

Swing system: 27.5 MPa {280 kgf/cm²}

Control system: 7.0 MPa {71 kgf/cm²}

Reservoir capacity: 535 liters



Boom Hoisting System

Powered by a hydraulic motor through a planetary reducer.

Brake: A spring-set, hydraulically released multiple-disc brake is mounted on the boom hoist motor and operated through a counter-balance valve.

Drum lock: External ratchet for locking drum

Drum: Single drum, grooved for 20 mm dia. wire rope

Line speed: Single line on first drum layer

Hoisting/Lowering: 48 to 2 m/min

Diameter of wire ropes

Boom guy line: 34 mm

Boom hoist reeving: 10 parts of 20 mm dia. high strength wire rope

Boom backstops: Telescopic type with spring bumper
Required for all boom lengths



Load Hoist System

Front and rear drums for load hoist powered by a hydraulic variable plunger motors, driven through planetary reducers.

Negative Brake: A spring-set, hydraulically released multiple-disc brake is mounted on the hoist motor and operated through a counter-balance valve. (Positive free fall brake is optional item.)

Drum lock: External ratchet for locking drum.

Drums:

Front drum:

666 mm P.C.D. x 672 mm Lg. wide drum, grooved for 26 mm wire rope. Rope capacity is 200 m working length and 351 m storage length.

Rear drum:

666 mm P.C.D. x 672 mm Lg. wide drum, grooved for 26 mm wire rope. Rope capacity is 155 m working length and 351 m storage length.

Note: Rope lengths listed above denote drum capacity and may differ from actual rope lengths supplied when machinery is shipped.

Line speed: Single line on the first drum layer

Hoisting/Lowering: 120 to 3 m/min

Tower jib Hoisting/Lowering: 60 to 3 m/min

Line Pull (Single-line):

Rated line pull: 108 kN {11.0 tf}



Swing System

Swing unit is powered by hydraulic motor driving spur gear through planetary reducer, the swing system provides 360° rotation.

Swing brakes: A spring-set, hydraulically released multiple-disc brake is mounted on swing motor.

Swing circle: Single-row ball bearing with an integral internally cut swing gear.

Swing lock: Manually, four position lock for transportation

Swing speed: 3.1 min⁻¹ {rpm}



Upper Structure

Torsion-free precision machined upper frame. All components are located clearly and service friendly. Engine with low noise level.

Counterweight: 32.8 ton (for crane boom)

34.3 ton (for tower jib)*

* 1.6 ton additional counterweight is required when tower jib is used.



Cab & Control

Totally enclosed, full vision cab with safety glass, fully adjustable, high backed seat with a head-rest and armrests, and intermittent wiper and window washer (skylight and front window).

Cab fittings:

Air conditioner, convenient compartment (for tool), cup holder, ashtray, cigarette lighter, sun visor, roof blind, tinted glass, floor mat, foot-rest, shoe tray

Controls:

Four adjustable levers for front drum, rear drum, boom drum and swing controls



Lower Structure

Steel-welded carbody with axles. Crawler assemblies are designed with quick disconnect feature for individual removal as a unit from axles. Also crawler assemblies can be hydraulically extended for wide-track operation or retracted for transportation. Crawler belt tension is maintained by hydraulic jack force on the track-adjusting bearing block.

Crawler drive: Independent hydraulic propel drive is built into each crawler side frame. Each drive consists of a hydraulic motor propelling a driving tumbler through a planetary gear box. Hydraulic motor and gear box are built into the crawler side frame within the shoe width.

Crawler brakes: Spring-set, hydraulically released parking brakes are built into each propel drive.

Steering mechanism: A hydraulic propel system provides both skid steering (driving one track only) and counter-rotating steering (driving each track in opposite directions).

Track rollers: Sealed track rollers for maintenance-free operation.

Shoes (flat): 59 shoes, 900 mm wide each crawler

Max. travel speed: 1.4/1.0 km/h

Max. gradeability: 30%



Weight

Including upper and lower machine, 32.8 ton counterweight (34.3 t counterweight for tower jib), basic boom (or basic tower + basic jib), hook, and other accessories.

Specification	Weight	Ground pressure
Crane boom	Approx. 91 ton,	93 kPa {0.95 kgf/cm ² }
Tower Jib	Approx. 99 ton,	101 kPa {1.03 kgf/cm ² }



Attachment

Boom and Jib:

Welded lattice construction using tubular, high-tensile steel chords with pin connections between sections.

Boom and Jib Length

	Min. Length (Min. Combination)	Max. Length (Max. Combination)
Crane Boom	13.8 m	62.6 m
Fixed Jib	29.1 m + 9.1 m	53.4 m + 21.3 m
Tower Jib	26.0 m + 18.8 m	44.3 m + 37.1 m

Main Specifications (Model:7090-1F)

Crane Boom	
Max. Lifting Capacity	90 t/4.3 m
Max. Length	62.6 m
Fixed Jib	
Max. Lifting Capacity	11 t/18.0 m
Max. Combination	53.4 m + 21.3 m
Tower Jib	
Max. Lifting Capacity	15 t/14.0 m
Max. Combination	44.3 m + 37.1 m
Tower Angle	60° ~ 90°
Main & Aux. Winch	
Max. Line Speed	120 m/min (1st layer)
Rated Line Pull (Single line)	108 kN {11.0 tf}
Wire Rope Diameter	26 mm
Wire Rope Length	Crane 200 m (Main) 155 m (Aux.)
	Tower 250 m (Main) 125 m (Aux.)
Brake Type	Spring set hydraulically released (Negative)
Free-Fall Brake Type	Wet-type multiple disc brake (Optional)

Working Speed	
Swing Speed	3.1 min ⁻¹ {rpm}
Travel Speed	1.4/1.0 km/h
Power Plant	
Model	Hino P11C-UN
Engine Output	247 kW/2,000 min ⁻¹ {rpm}
Fuel Tank Capacity	400 liters
Hydraulic System	
Main Pumps	4 variable displacement
Max. Pressure	31.9 MPa {325 kgf/cm ² }
Hydraulic Tank Capacity	535 liters
Weight	
Operating Weight*	Approx. 91 t
Ground Pressure*	93 kPa {0.95 kgf/cm ² }
Counterweight	32.8 t (34.3 t for Tower Jib)
Transport Weight**	Approx. 34.8 t

* Including upper and lower machine, 32.8 ton counterweight, basic boom, hook, and other accessories.

** Base machine with boom base, gantry, carbody, lower spreader and upper spreader. (Refer to P25)

Units are SI units. { } indicates conventional units.

GENERAL DIMENSIONS

Crane Boom

(Unit: mm)

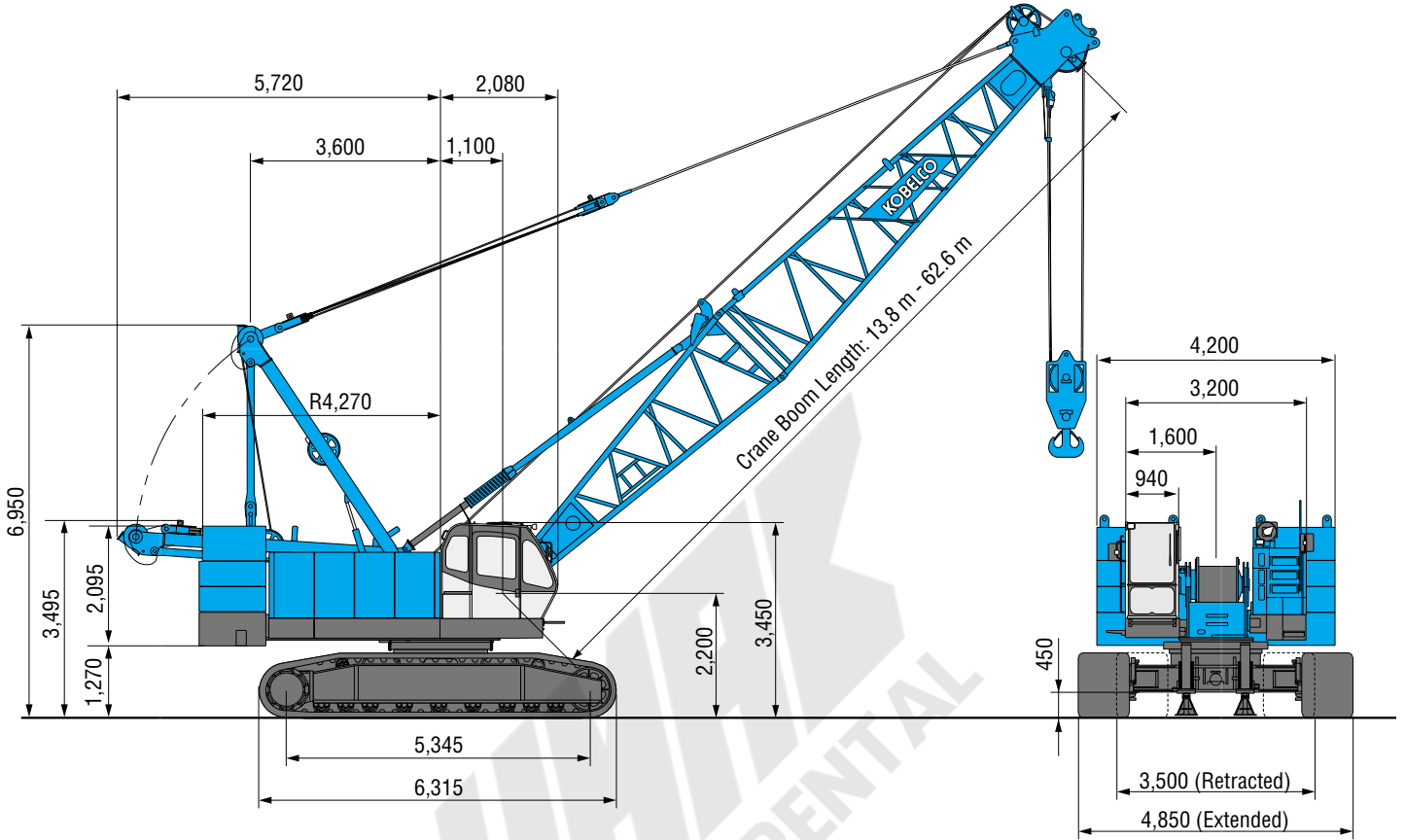

Limit of Hook Lifting

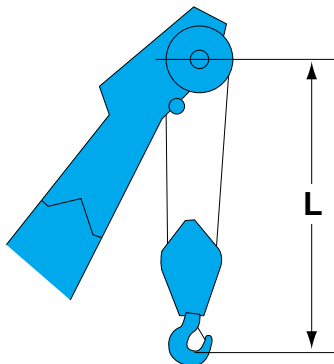

Hook	L
90 t hook	5.0 m
50 t hook	5.0 m
35 t hook	5.0 m

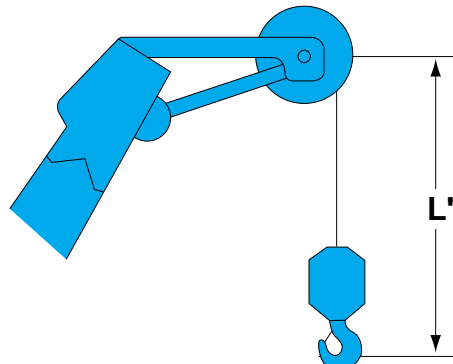

Hook	L'
11 t Ball hook	4.2 m

Tower Jib

(Unit: mm)

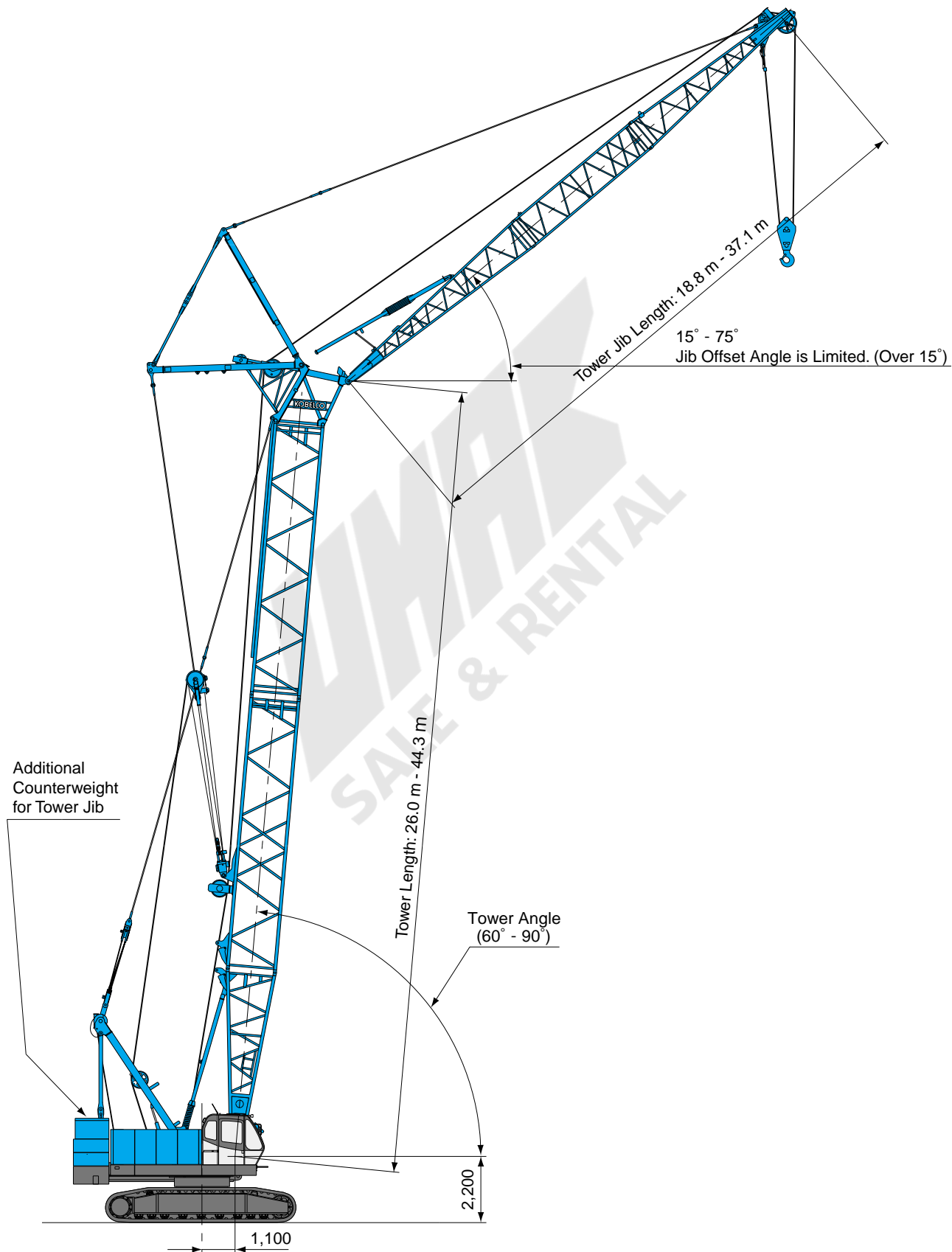

BOOM AND JIB ARRANGEMENTS

Crane Boom Arrangements

Boom length m (ft)	Boom arrangement
13.8 (45)	
16.9 (55)	
19.9 (65)	
23.0 (75)	
26.0 (85)	
29.1 (95)	
32.1 (105)	
35.2 (115)	
38.2 (125)	

Boom length m (ft)	Boom arrangement
41.2 (135)	
44.3 (145)	
47.3 (155)	
50.4 (165)	
53.4 (175)	
56.5 (185)	
59.5 (195)	
62.6 (205)	

Symbol	Boom Length	Remarks
	6.2 m	Boom Base
	7.6 m	Boom Top
	3.0 m	Insert Boom
	6.1 m	Insert Boom
	9.1 m	Insert Boom
	9.1 m	Insert Boom with Lug
	9.1 m	Special Insert Boom for Tower

Note

1. ↗ mark shows the guy line installing position when the fixed jib is used.
2. ※ mark shows the standard boom arrangement which enables each boom length of less than that boom length to be configured.
3. 9.1 m insert boom with lug (9.1A) is required when the fixed jib is used.
4. 9.1B is designed for tower use, but may also be used with a crane boom.

Fixed Jib Arrangements

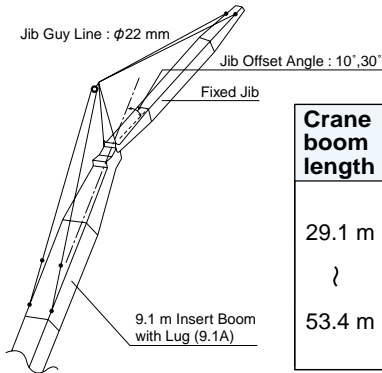

Crane boom length	Jib length m (ft)	Jib arrangement
29.1 m	9.1 (30)	
	15.2 (50)	
53.4 m	21.3 (70)	

Symbol	Jib Length	Remarks
	4.6 m	Jib Base
	4.6 m	Jib Top
	6.1 m	Insert Jib



Hook Blocks

A range of hook blocks can be specified, each with a safety latch.

Hooks	Weight (kg)	No. of sheaves	No. of lines and max. rated loads (tons)							
			1	2	3	4	5	6	7	8
90-ton	1,300	4	-	-	33.0	44.0	55.0	66.0	77.0	90.0
50-ton	850	3	-	-	33.0	44.0	50.0	-	-	-
35-ton	700	1	-	22.0	33.0	-	-	-	-	-
11-ton ball hook	300	0	11.0	-	-	-	-	-	-	-

Symbols for Attachments:

Crane Boom	Auxiliary Sheave for Crane Boom	Fixed Jib	Tower Jib

Tower Arrangements

Tower length m (ft)	Tower arrangement
26.0 (85)	
29.1 (95)	
32.1 (105)	
35.2 (115)	
38.2 (125)	
41.2 (135)	
44.3 (145)	

Symbol	Tower Length	Remarks
	6.2 m	Boom Base
	1.5 m	Tower Cap
	3.0 m	Insert Boom
	6.1 m	Insert Boom
	9.1 m	Insert Boom
	9.1 m	Insert Boom with Lug
	9.1 m	Special Insert Boom for Tower

※ mark shows the standard tower arrangement which enables each tower length of less than that tower length to be configured.
9.1B may also be used as insert boom for crane boom.

Tower Jib Arrangements

Jib length m (ft)	Jib arrangement
18.8 (62)	
21.8 (72)	
24.9 (82)	
27.9 (92)	
31.0 (102)	
34.0 (112)	
37.1 (122)	

Symbol	Tower Jib Length	Remarks
	7.6 m	Tower Jib Base
	6.1 m	Tower Jib Top
	5.1 m	Tapered Tower Jib
	3.0 m	Tower Insert Jib
	6.1 m	Tower Insert Jib
	9.1 m	Tower Insert Jib

※ mark shows the standard tower jib arrangement which enables each tower jib length of less than that jib length to be configured.
○ : indicates position where cable rollers attached

Tower and Jib Combinations and Allowable Tower Angle

Tower length \ Jib length		18.8 m	21.8 m	24.9 m	27.9 m	31.0 m	34.0 m	37.1 m	Pillow plate
		18.8 m	21.8 m	24.9 m	27.9 m	31.0 m	34.0 m	37.1 m	
26.0 m	26.0 m	90°-60°	90°-60°	—	—	—	—	—	—
29.1 m	29.1 m	90°-60°	90°-60°	90°-60°	—	—	—	—	—
32.1 m	32.1 m	90°-60°	90°-60°	90°-60°	90°-60°	—	—	—	—
35.2 m	35.2 m	90°-60°	90°-60°	90°-60°	90°-60°	90°-60°	—	—	—
38.2 m	38.2 m	90°-60°	90°-60°	90°-60°	90°-60°	90°-70°	90°-70°	—	—
41.2 m	41.2 m	90°-60°	90°-60°	90°-70°	90°-70°	90°-70°	90°-70°	90°-70°	Need
44.3 m	44.3 m	90°-70°	90°-70°	90°-70°	90°-70°	90°-70°	90°-70°	90°-70°	Need
Hook	35 ton hook	○	○	○	○	○	○	×	X
	Ball hook	×	○	○	○	○	○	○	

○ : Available × : Not available

WORKING RANGES AND LIFTING CAPACITIES

Crane Boom Working Ranges

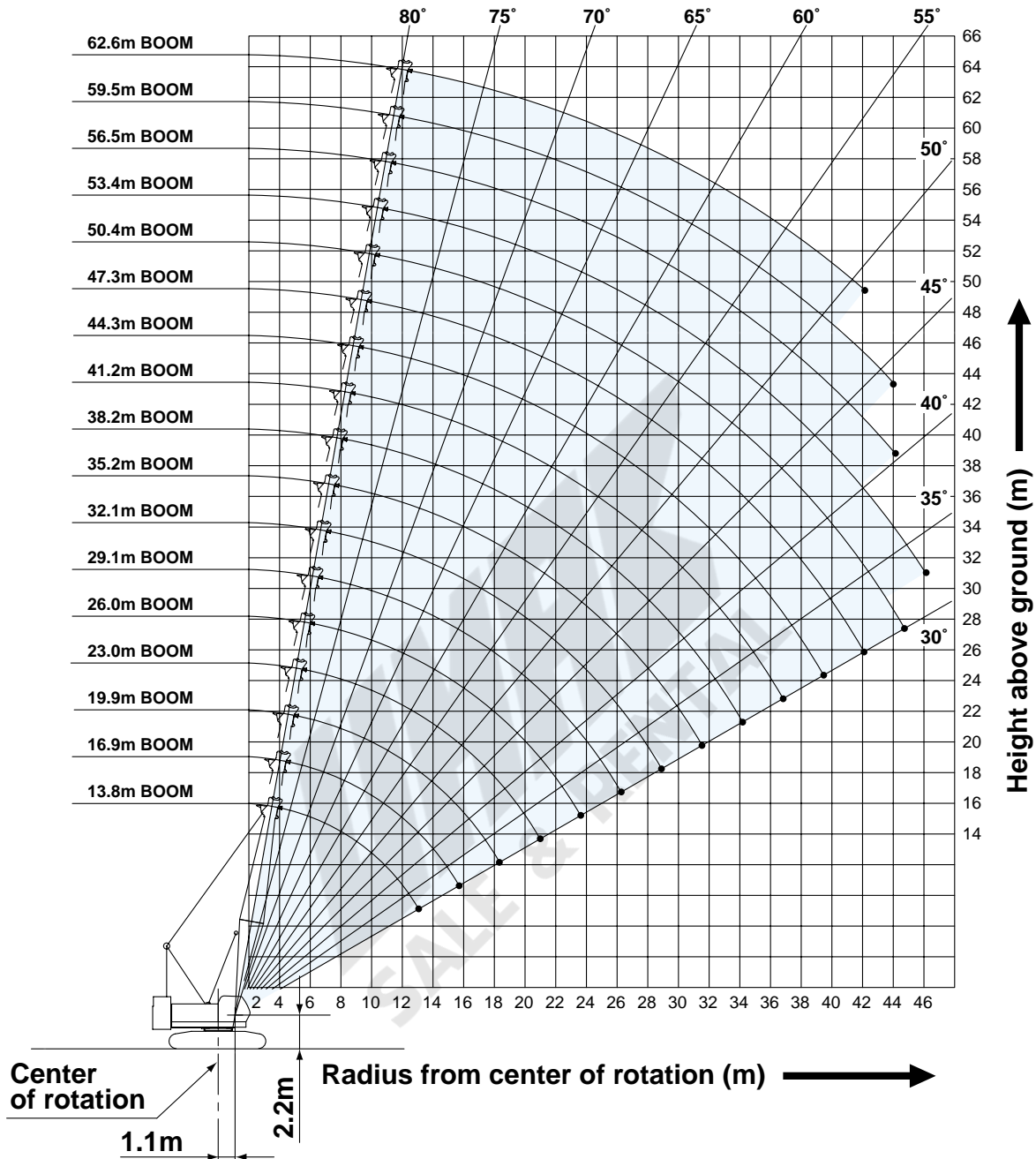

NOTES:

- Ratings according to Japanese Construction Codes for Mobile Cranes and Japanese Safety Ordinance on Cranes, etc.
- Ratings in metric tons for 360° working area.
- Operating radius is the horizontal distance from center of rotation to a vertical line through the center of gravity of the load.
- Weight of hook block(s), slings and other load handling accessories is included in rated load. Their total weight must be subtracted from rated load to obtain weight that can be lifted.
- Ratings shown are based on freely suspended loads and make no allowance for such factors as wind effect on lifted load, ground conditions out-of-level, operating speeds or any other condition that could be detrimental to the safe operation of this equipment. Operator, therefore, has the responsibility to judge the existing conditions and reduce lifted loads and operating speeds accordingly.
- Ratings are for operation on a firm and level surface.
- At radii and boom lengths where no ratings are shown on chart, operation is not intended nor approved.
- Boom inserts and guy lines must be arranged as shown in the "Operator's Manual".
- Boom hoist reeving is 10 part line.
- Gantry must be in raised position for all conditions.
- Boom backstops are required for all boom lengths.
- Crawler frames must be fully extended for all crane operations.
- Ratings shown in are determined by the strength of the boom or other structural component.
- When erecting or lowering the boom length of 59.5 m or over, the pillow plate for erection must be placed at the end of crawlers.
- Instruction in the "Operator's Manual" must be strictly observed when operating the machine.
- Crane boom ratings: Deduct weight of main hook block, slings, and all other load handling accessories from crane boom ratings shown.
- Auxiliary sheave ratings for crane boom: Deduct weight of ball hook, slings, and all other load handling accessories from auxiliary sheave ratings for crane boom shown.
- Crane boom lengths for auxiliary sheave mounting are 13.8 m to 59.5 m.
- Crane boom ratings with auxiliary sheave: Deduct 0.8 ton from crane boom ratings shown. Minimum rated loads must exceed 1.5 ton.



Crane Boom Lifting Capacity

Unit: metric ton

Counterweight: 32.8 t

Working radius (m)	Boom Length (m)													Working radius (m)
	13.8	16.9	19.9	23.0	26.0	29.1	32.1	35.2	38.2	41.2	44.3	47.3	50.4	
4.3	4.3m/90.0	4.3m/87.5	4.8m/74.1											4.3
5.0	70.9	70.8	70.7	5.4m/64.9	5.9m/56.4									5.0
6.0	55.1	55.0	55.0	54.9	54.8	6.4m/50.2								6.0
7.0	44.4	44.3	44.1	44.1	44.0	44.0	43.9	7.5m/39.6						7.0
8.0	36.6	36.5	36.3	36.2	36.1	36.1	36.0	35.9	35.7	8.5m/32.5				8.0
9.0	31.0	30.9	30.7	30.7	30.5	30.5	30.4	30.3	30.2	30.2	9.1m/29.7	9.6m/27.2		9.0
10.0	26.9	26.7	26.6	26.5	26.4	26.3	26.3	26.1	26.0	26.0	25.8	25.7	10.1m/22.0	10.0
12.0	21.1	21.0	20.8	20.7	20.6	20.5	20.4	20.3	20.2	20.1	20.0	19.8	19.8	12.0
14.0	13.2m/18.7	17.1	16.9	16.9	16.7	16.6	16.6	16.4	16.3	16.2	16.1	16.0	15.9	14.0
16.0		15.8m/14.6	14.2	14.1	14.0	13.9	13.8	13.7	13.5	13.5	13.3	13.2	13.2	16.0
18.0			12.2	12.1	11.9	11.9	11.8	11.6	11.5	11.4	11.2	11.1	11.1	18.0
20.0			18.5m/11.8	10.5	10.4	10.3	10.2	10.0	9.9	9.8	9.6	9.5	9.5	20.0
22.0				21.1m/9.8	9.1	9.0	8.9	8.7	8.6	8.5	8.4	8.2	8.2	22.0
24.0					23.8m/8.2	8.0	7.9	7.7	7.6	7.5	7.3	7.2	7.1	24.0
26.0						7.2	7.0	6.8	6.7	6.6	6.5	6.3	6.3	26.0
28.0						26.4m/7.0	6.3	6.1	6.0	5.9	5.7	5.6	5.5	28.0
30.0							29.0m/6.0	5.5	5.4	5.3	5.1	5.0	4.9	30.0
32.0								31.7m/5.1	4.8	4.8	4.6	4.4	4.4	32.0
34.0									4.4	4.3	4.1	4.0	3.9	34.0
36.0									34.3m/4.3	3.9	3.7	3.5	3.5	36.0
38.0										37.0m/3.7	3.3	3.2	3.1	38.0
40.0											39.6m/3.1	2.9	2.8	40.0
42.0												2.5	2.4	42.0
44.0												42.2m/2.5	2.1	44.0
46.0													44.9m/2.0	46.0
Reeves	8	8	7	6	6	5	4	4	4	3	3	3	2	Reeves

Working radius (m)	Boom Length (m)				Working radius (m)
	53.4	56.5	59.5	62.6	
10.0	10.7m/22.0	11.2m/21.6	11.7m/20.1		10.0
12.0	19.7	19.5	19.4	12.2m/18.7	12.0
14.0	15.8	15.6	15.5	15.4	14.0
16.0	13.0	12.9	12.7	12.6	16.0
18.0	10.9	10.8	10.7	10.5	18.0
20.0	9.3	9.2	9.1	8.9	20.0
22.0	8.0	7.9	7.8	7.6	22.0
24.0	7.0	6.9	6.7	6.6	24.0
26.0	6.1	6.0	5.8	5.7	26.0
28.0	5.4	5.2	5.1	4.9	28.0
30.0	4.7	4.6	4.5	4.3	30.0
32.0	4.2	4.1	3.9	3.8	32.0
34.0	3.7	3.6	3.4	3.2	34.0
36.0	3.3	3.2	3.0	2.7	36.0
38.0	2.9	2.7	2.5	2.3	38.0
40.0	2.5	2.3	2.1	1.9	40.0
42.0	2.2	2.0	1.8	1.5	42.0
44.0	1.8	1.7	1.5		44.0
46.0	1.6				46.0
Reeves	2	2	2	2	Reeves

Note:
 Ratings according to Japanese Construction Codes for Mobile Cranes and Japanese Safety Ordinance on Cranes, etc.
 Ratings shown in are determined by the strength of the boom or other structural components.
 Refer to notes P10.



Auxiliary Sheave Lifting Capacity for Crane Boom (Without Main Hook)

Unit: metric ton

Counterweight: 32.8 t

Working radius (m)	Boom Length (m)		13.8	16.9	19.9	23.0	26.0	29.1	32.1	35.2	38.2	41.2	44.3	47.3	50.4	Boom Length (m)	
	Working radius (m)	Working radius (m)														Working radius (m)	Working radius (m)
5.0	5.2m/11.0	5.2m/11.0	5.7m/11.0														5.0
6.0	11.0	11.0	11.0	6.3m/11.0	6.8m/11.0												6.0
7.0	11.0	11.0	11.0	11.0	11.0	7.3m/11.0	7.9m/11.0										7.0
8.0	11.0	11.0	11.0	11.0	11.0	11.0	11.0	8.4m/11.0	8.9m/11.0								8.0
9.0	11.0	11.0	11.0	11.0	11.0	11.0	11.0	11.0	11.0	9.4m/11.0							9.0
10.0	11.0	11.0	11.0	11.0	11.0	11.0	11.0	11.0	11.0	11.0	10.0m/11.0	10.5m/11.0	11.0m/11.0				10.0
12.0	11.0	11.0	11.0	11.0	11.0	11.0	11.0	11.0	11.0	11.0	11.0	11.0	11.0	11.0			12.0
14.0	11.0	11.0	11.0	11.0	11.0	11.0	11.0	11.0	11.0	11.0	11.0	11.0	11.0	11.0			14.0
16.0	14.6m/11.0	11.0	11.0	11.0	11.0	11.0	11.0	11.0	11.0	11.0	11.0	11.0	11.0	11.0			16.0
18.0		17.2m/10.5	11.0	11.0	11.0	11.0	11.0	11.0	11.0	11.0	11.0	11.0	10.8	10.7	10.7		18.0
20.0			19.9m/9.9	10.1	10.0	9.9	9.8	9.6	9.5	9.4	9.2	9.1	9.1				20.0
22.0				8.5	8.7	8.6	8.5	8.3	8.2	8.1	8.0	7.8	7.8				22.0
24.0				22.5m/8.1	7.4	7.6	7.5	7.3	7.2	7.1	6.9	6.8	6.7				24.0
26.0					25.2m/6.6	6.8	6.6	6.4	6.3	6.2	6.1	5.9	5.9				26.0
28.0						27.8m/6.1	5.9	5.7	5.6	5.5	5.3	5.2	5.1				28.0
30.0							5.2	5.1	5.0	4.9	4.7	4.6	4.5				30.0
32.0								30.4m/5.1	4.5	4.4	4.4	4.2	4.0	4.0			32.0
34.0									33.1m/4.2	4.0	3.9	3.7	3.6	3.5			34.0
36.0										35.7m/3.7	3.5	3.3	3.1	3.1			36.0
38.0											3.1	2.9	2.8	2.7			38.0
40.0												38.4m/3.0	2.5	2.5	2.4		40.0
42.0													41.0m/2.3	2.1	2.0		42.0
44.0														43.6m/1.8	1.7		44.0
46.0															1.6		46.0
Reeves	1	1	1	1	1	1	1	1	1	1	1	1	1	1	1	1	Reeves

Working radius (m)	Boom Length (m)		53.4	56.5	59.5	Boom Length (m)	
	Working radius (m)	Working radius (m)				Working radius (m)	Working radius (m)
10.0	11.5m/11.0						10.0
12.0	11.0	12.1m/11.0	12.6m/11.0				12.0
14.0	11.0	11.0	11.0				14.0
16.0	11.0	11.0	11.0				16.0
18.0	10.5	10.4	10.3				18.0
20.0	8.9	8.8	8.7				20.0
22.0	7.6	7.5	7.4				22.0
24.0	6.6	6.5	6.3				24.0
26.0	5.7	5.6	5.4				26.0
28.0	5.0	4.8	4.7				28.0
30.0	4.3	4.2	4.1				30.0
32.0	3.8	3.7	3.5				32.0
34.0	3.3	3.2	3.0				34.0
36.0	2.9	2.8	2.6				36.0
38.0	2.5	2.3	2.1				38.0
40.0	2.1	1.9	1.7				40.0
42.0	1.8	1.6					42.0
44.0							44.0
46.0							46.0
Reeves	1	1	1				Reeves

Note:
 Ratings according to Japanese Construction Codes for Mobile Cranes and Japanese Safety Ordinance on Cranes, etc.
 Ratings shown in are determined by the strength of the boom or other structural components.
 Refer to notes P10.

Fixed Jib Working Ranges

Jib Offset Angle: 10°, 30°

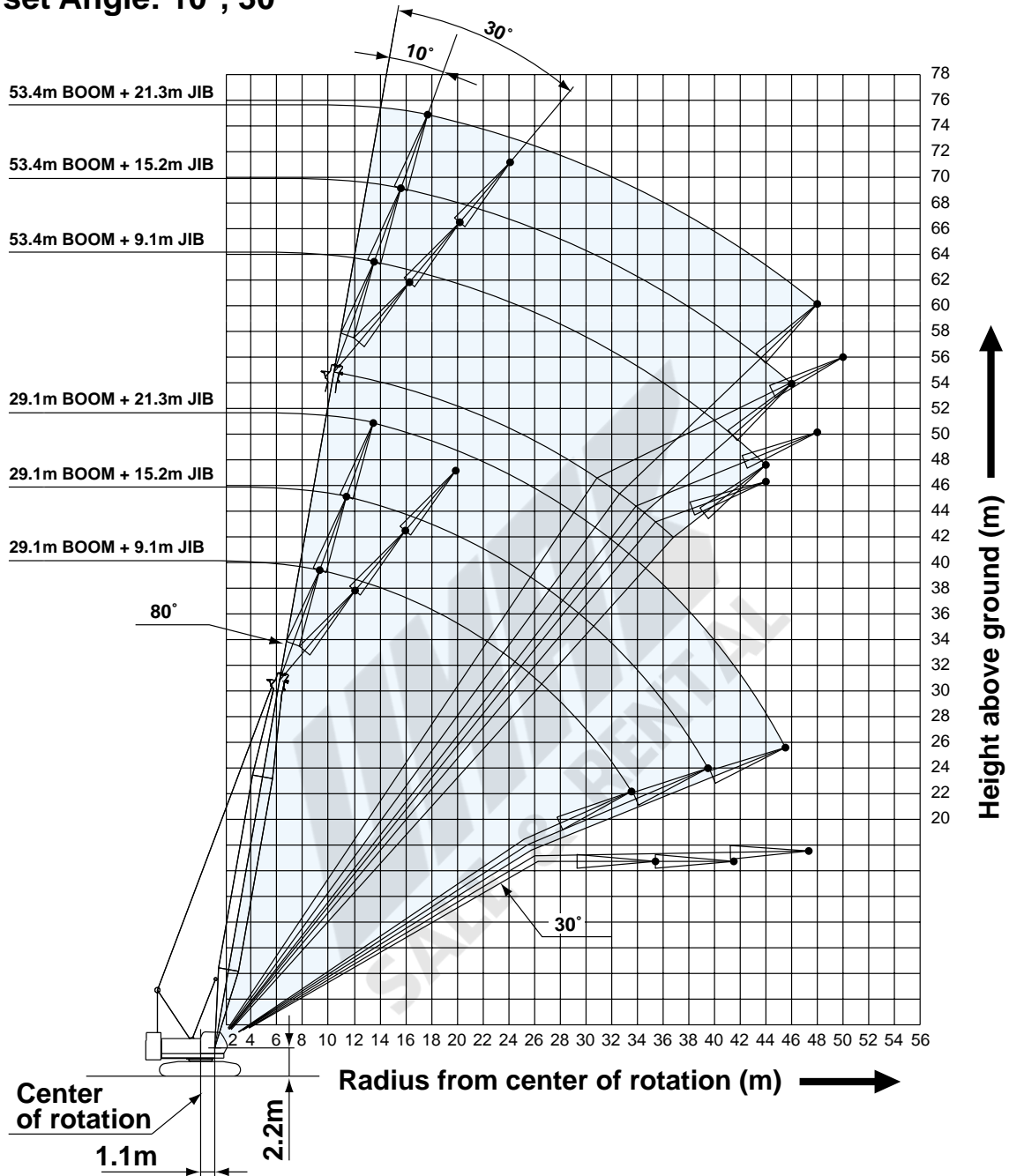

NOTES:

1. Ratings according to Japanese Construction Codes for Mobile Cranes and Japanese Safety Ordinance on Cranes, etc.
2. Ratings in metric tons for 360° working area.
3. Operating radius is the horizontal distance from center of rotation to a vertical line through the center of gravity of the load.
4. Weight of hook block(s), slings and other load handling accessories is included in rated load. Their total weight must be subtracted from rated load to obtain weight that can be lifted.
5. Ratings shown are based on freely suspended loads and make no allowance for such factors as wind effect on lifted load, ground conditions out-of-level, operating speeds or any other condition that could be detrimental to the safe operation of this equipment. Operator, therefore, has the responsibility to judge the existing conditions and reduce lifted loads and operating speeds accordingly.
6. Ratings are for operation on a firm and level surface.
7. At radii and boom lengths where no ratings are shown on chart, opera-

- tion is not intended nor approved.
8. Boom/jib inserts and guy lines must be arranged as shown in the "Operator's Manual".
9. Gantry must be in raised position for all conditions.
10. Boom backstops are required for all crane lengths.
11. Crawler frames must be fully extended for all crane operations.
12. Ratings shown in are determined by the strength of the boom or other structural component.
13. When erecting or lowering the boom length of 53.4 m with fixed jib attached, the pillow plate for erection must be placed at the end of crawlers.
14. Instruction in the "Operator's Manual" must be strictly observed when operating the machine.
15. Fixed jib ratings: Deduct weight of jib hook block, slings, and all other load handling accessories from fixed jib ratings shown.
16. Crane boom lengths for fixed jib mounting are 29.1 m to 53.4 m.



HYDRAULIC CRAWLER CRANE

7090

Fixed Jib Lifting Capacities (Without Main Hook)

Unit: metric ton

Jib Offset Angle: 10°

Counterweight: 32.8 t

Boom length (m)	29.1			32.1			35.2			38.2			41.2			Boom length (m)	
Jib length (m)	9.1	15.2	21.3	9.1	15.2	21.3	9.1	15.2	21.3	9.1	15.2	21.3	9.1	15.2	21.3	Jib length (m)	
Working radius (m)	9.0	9.6m/11.0														9.0	
	10.0	11.0	11.7m/9.1		10.2m/11.0					10.7m/11.0			11.2m/11.0			11.7m/11.0	10.0
	12.0	11.0	9.1	13.8m/7.2	11.0	12.2m/9.1				11.0	12.8m/9.1			11.0	13.3m/9.1		12.0
	14.0	11.0	9.1	7.0	11.0	9.1	14.3m/7.1	11.0	9.1	14.9m/7.1	11.0	9.1	15.4m/7.2	11.0	9.1	15.9m/7.2	14.0
	16.0	11.0	9.1	6.9	11.0	9.1	6.9	11.0	9.1	7.0	11.0	9.1	7.0	11.0	9.1	7.0	16.0
	18.0	11.0	9.1	6.7	11.0	9.1	6.7	11.0	9.1	6.8	11.0	9.1	6.8	11.0	9.1	6.9	18.0
	20.0	10.5	9.1	6.5	10.3	9.1	6.6	10.2	9.1	6.6	10.0	9.1	6.7	9.9	9.1	6.7	20.0
	22.0	9.2	8.9	6.3	9.0	9.1	6.4	8.9	9.1	6.5	8.7	8.9	6.5	8.6	8.8	6.6	22.0
	24.0	8.1	8.2	6.1	8.0	8.2	6.2	7.8	8.0	6.3	7.7	7.9	6.4	7.5	7.7	6.5	24.0
	26.0	7.2	7.4	5.8	7.1	7.3	6.0	6.9	7.1	6.1	6.8	7.0	6.2	6.6	6.8	6.3	26.0
	28.0	6.5	6.7	5.4	6.3	6.5	5.7	6.2	6.4	5.9	6.0	6.2	6.0	5.9	6.1	6.1	28.0
	30.0	5.9	6.0	5.0	5.7	5.9	5.3	5.5	5.7	5.5	5.4	5.6	5.8	5.3	5.4	5.7	30.0
	32.0	5.3	5.5	4.7	5.2	5.3	4.9	5.0	5.2	5.2	4.8	5.0	5.2	4.7	4.9	5.1	32.0
	34.0	4.8	5.0	4.4	4.7	4.8	4.6	4.5	4.7	4.9	4.4	4.5	4.8	4.2	4.4	4.6	34.0
	36.0		4.6	4.2	4.3	4.4	4.4	4.1	4.2	4.4	3.9	4.1	4.3	3.8	4.0	4.2	36.0
	38.0		4.2	3.9		4.0	4.1	3.7	3.9	4.1	3.6	3.7	3.9	3.4	3.6	3.8	38.0
	40.0		3.8	3.7		3.7	3.9	3.4	3.5	3.7	3.2	3.4	3.6	3.1	3.2	3.4	40.0
	42.0			3.5		3.4	3.6		3.2	3.4	2.9	3.1	3.3	2.8	2.9	3.1	42.0
44.0			3.3			3.3		2.9	3.1		2.8	3.0	2.5	2.7	2.9	44.0	
46.0			3.1			3.0		2.7	2.9		2.6	2.7		2.4	2.6	46.0	
48.0						2.8			2.6		2.3	2.5		2.1	2.4	48.0	
50.0									2.4			2.3		1.9	2.1	50.0	
52.0												2.1			1.9	52.0	
54.0												1.9			1.7	54.0	
Reeves	1	1	1	1	1	1	1	1	1	1	1	1	1	1	1	Reeves	

Boom length (m)	44.3			47.3			50.4			53.4			Boom length (m)				
Jib length (m)	9.1	15.2	21.3	9.1	15.2	21.3	9.1	15.2	21.3	9.1	15.2	21.3	Jib length (m)				
Working radius (m)	12.0	12.3m/11.0			12.8m/11.0					13.3m/11.0			13.9m/11.0			12.0	
	14.0	11.0	14.4m/9.1		11.0	14.9m/9.1				11.0	15.4m/9.1			11.0	15.9m/9.1	14.0	
	16.0	11.0	9.1	16.4m/7.1	11.0	9.1	17.0m/7.1	11.0	9.1	17.5m/7.1	11.0	9.1	7.0	11.0	9.1	16.0	
	18.0	11.0	9.1	6.9	11.0	9.1	7.0	11.0	9.1	7.0	11.0	9.1	7.0	11.0	9.1	18.0	
	20.0	9.7	9.1	6.8	9.6	9.1	6.8	9.5	9.1	6.9	9.3	9.1	6.9	9.3	9.1	20.0	
	22.0	8.4	8.7	6.6	8.3	8.5	6.7	8.2	8.4	6.7	8.0	8.3	6.8	8.0	8.3	6.8	22.0
	24.0	7.4	7.6	6.5	7.2	7.5	6.6	7.1	7.3	6.6	6.9	7.2	6.6	6.9	7.2	6.6	24.0
	26.0	6.5	6.7	6.4	6.3	6.6	6.4	6.2	6.4	6.5	6.0	6.3	6.5	6.0	6.3	6.5	26.0
	28.0	5.7	5.9	6.2	5.6	5.8	6.1	5.4	5.7	6.0	5.3	5.5	5.8	5.3	5.5	5.8	28.0
	30.0	5.1	5.3	5.5	4.9	5.1	5.4	4.8	5.0	5.3	4.6	4.8	5.2	4.6	4.8	5.2	30.0
	32.0	4.5	4.7	5.0	4.4	4.6	4.9	4.2	4.4	4.7	4.1	4.3	4.6	4.1	4.3	4.6	32.0
	34.0	4.0	4.2	4.5	3.9	4.1	4.4	3.8	3.9	4.2	3.6	3.8	4.1	3.6	3.8	4.1	34.0
	36.0	3.6	3.8	4.0	3.5	3.7	3.9	3.3	3.5	3.8	3.2	3.3	3.6	3.2	3.3	3.6	36.0
	38.0	3.2	3.4	3.6	3.1	3.3	3.5	2.9	3.1	3.4	2.7	2.9	3.2	2.7	2.9	3.2	38.0
	40.0	2.9	3.1	3.3	2.7	2.9	3.2	2.5	2.8	3.0	2.3	2.5	2.9	2.3	2.5	2.9	40.0
	42.0	2.6	2.8	3.0	2.4	2.6	2.9	2.2	2.4	2.7	1.9	2.2	2.5	1.9	2.2	2.5	42.0
	44.0	2.3	2.5	2.7	2.1	2.3	2.6	1.8	2.1	2.4	1.6	1.8	2.2	1.6	1.8	2.2	44.0
	46.0	2.0	2.2	2.4	1.8	2.0	2.3	1.6	1.8	2.1			1.5	1.5	1.9		46.0
48.0	1.7	1.9	2.2	1.5	1.7	2.0		1.5	1.8					1.6		48.0	
50.0		1.6	1.9			1.7			1.5							50.0	
52.0			1.7			1.5										52.0	
54.0																54.0	
Reeves	1	1	1	1	1	1	1	1	1	1	1	1	1	1	1	Reeves	

Note:
 Ratings according to Japanese Construction Codes for Mobile Cranes and Japanese Safety Ordinance on Cranes, etc.
 Ratings shown in are determined by the strength of the boom or other structural components.
 Refer to notes P13.

Unit: metric ton

Jib Offset Angle: 30°

Counterweight: 32.8 t

Boom length (m)	29.1			32.1			35.2			38.2			41.2			Boom length (m)
Jib length (m)	9.1	15.2	21.3	9.1	15.2	21.3	9.1	15.2	21.3	9.1	15.2	21.3	9.1	15.2	21.3	Jib length (m)
12.0	12.4m/9.5			12.9m/9.5			13.4m/9.5									12.0
14.0	9.5			9.5			9.5			9.5			14.5m/9.5			14.0
16.0	9.5	16.3m/5.2		9.5	16.8m/5.2		9.5	17.4m/5.2		9.5	17.9m/5.2		9.5			16.0
18.0	9.5	5.2		9.5	5.2		9.5	5.2		9.5	5.2		9.5	18.4m/5.2		18.0
20.0	9.5	5.2	20.2m/3.7	9.5	5.2	20.7m/3.7	9.5	5.2	21.3m/3.7	9.5	5.2	21.8m/3.7	9.5	5.2		20.0
22.0	9.3	5.2	3.7	9.3	5.2	3.7	9.1	5.2	3.7	9.0	5.2	3.7	8.9	5.2	22.3m/3.7	22.0
24.0	8.3	5.2	3.7	8.2	5.2	3.7	8.0	5.2	3.7	7.9	5.2	3.7	7.8	5.2	3.7	24.0
26.0	7.4	5.2	3.7	7.3	5.2	3.7	7.1	5.2	3.7	7.0	5.2	3.7	6.9	5.2	3.7	26.0
28.0	6.6	5.1	3.7	6.5	5.2	3.7	6.3	5.2	3.7	6.2	5.2	3.7	6.1	5.2	3.7	28.0
30.0	6.0	4.9	3.6	5.8	5.1	3.7	5.7	5.2	3.7	5.6	5.2	3.7	5.4	5.2	3.7	30.0
32.0	5.4	4.7	3.4	5.3	4.9	3.5	5.1	5.0	3.6	5.0	5.1	3.7	4.9	5.2	3.7	32.0
34.0	4.9	4.6	3.3	4.8	4.7	3.4	4.6	4.8	3.5	4.5	4.9	3.6	4.4	4.7	3.6	34.0
36.0	4.4	4.4	3.2	4.3	4.6	3.3	4.2	4.5	3.4	4.0	4.4	3.4	3.9	4.3	3.5	36.0
38.0		4.3	3.1	3.9	4.2	3.2	3.8	4.1	3.2	3.7	4.0	3.3	3.5	3.9	3.4	38.0
40.0		4.0	3.0		3.9	3.1	3.4	3.7	3.1	3.3	3.6	3.2	3.2	3.5	3.3	40.0
42.0		3.6	2.9		3.5	3.0		3.4	3.0	3.0	3.3	3.1	2.9	3.2	3.2	42.0
44.0			2.8		3.2	2.9		3.1	2.9	2.7	3.0	3.0	2.6	2.9	3.1	44.0
46.0			2.7			2.8		2.8	2.8		2.7	2.9	2.3	2.6	2.8	46.0
48.0			2.6			2.7			2.7		2.5	2.7		2.3	2.5	48.0
50.0						2.6			2.5		2.2	2.4		2.1	2.3	50.0
52.0									2.3			2.2		1.8	2.1	52.0
54.0												2.0			1.8	54.0
56.0												1.7			1.6	56.0
Reeves	1	1	1	1	1	1	1	1	1	1	1	1	1	1	1	Reeves

Boom length (m)	44.3			47.3			50.4			53.4			Boom length (m)
Jib length (m)	9.1	15.2	21.3	9.1	15.2	21.3	9.1	15.2	21.3	9.1	15.2	21.3	Jib length (m)
14.0	15.0m/9.5			15.5m/9.5									14.0
16.0	9.5			9.5			16.1m/9.5			16.6m/9.5			16.0
18.0	9.5	18.9m/5.2		9.5	19.5m/5.2		9.5			9.5			18.0
20.0	9.5	5.2		9.5	5.2		9.5	5.2		9.5	20.5m/5.2		20.0
22.0	8.8	5.2	22.9m/3.7	8.7	5.2	23.4m/3.7	8.6	5.2	23.9m/3.7	8.4	5.2		22.0
24.0	7.7	5.2	3.7	7.6	5.2	3.7	7.4	5.2	3.7	7.3	5.2	24.4m/3.7	24.0
26.0	6.7	5.2	3.7	6.6	5.2	3.7	6.5	5.2	3.7	6.4	5.2	3.7	26.0
28.0	6.0	5.2	3.7	5.8	5.2	3.7	5.7	5.2	3.7	5.6	5.2	3.7	28.0
30.0	5.3	5.2	3.7	5.2	5.2	3.7	5.0	5.2	3.7	4.9	5.2	3.7	30.0
32.0	4.7	5.1	3.7	4.6	5.0	3.7	4.5	4.9	3.7	4.3	4.8	3.7	32.0
34.0	4.2	4.6	3.7	4.1	4.5	3.7	4.0	4.4	3.7	3.8	4.3	3.7	34.0
36.0	3.8	4.2	3.6	3.6	4.0	3.6	3.5	3.9	3.7	3.4	3.8	3.7	36.0
38.0	3.4	3.7	3.5	3.2	3.6	3.5	3.1	3.5	3.6	2.9	3.4	3.6	38.0
40.0	3.0	3.4	3.3	2.9	3.3	3.4	2.7	3.1	3.4	2.5	3.0	3.3	40.0
42.0	2.7	3.0	3.2	2.5	2.9	3.2	2.3	2.8	3.1	2.1	2.7	2.9	42.0
44.0	2.3	2.7	3.0	2.2	2.6	2.9	2.0	2.5	2.8	1.8	2.3	2.6	44.0
46.0	2.0	2.5	2.7	1.9	2.3	2.6	1.7	2.1	2.5		2.0	2.3	46.0
48.0	1.8	2.2	2.4	1.6	2.0	2.3		1.8	2.2		1.6	2.0	48.0
50.0		1.9	2.2		1.7	2.0		1.6	1.9			1.7	50.0
52.0		1.6	1.9		1.5	1.7			1.6				52.0
54.0			1.6			1.5							54.0
56.0													56.0
Reeves	1	1	1	1	1	1	1	1	1	1	1	1	Reeves

Note:
 Ratings according to Japanese Construction Codes for Mobile Cranes and Japanese Safety Ordinance on Cranes, etc.
 Ratings shown in are determined by the strength of the boom or other structural components.
 Refer to notes P13.

Tower Jib Working Ranges

Tower Length: 35.2 m

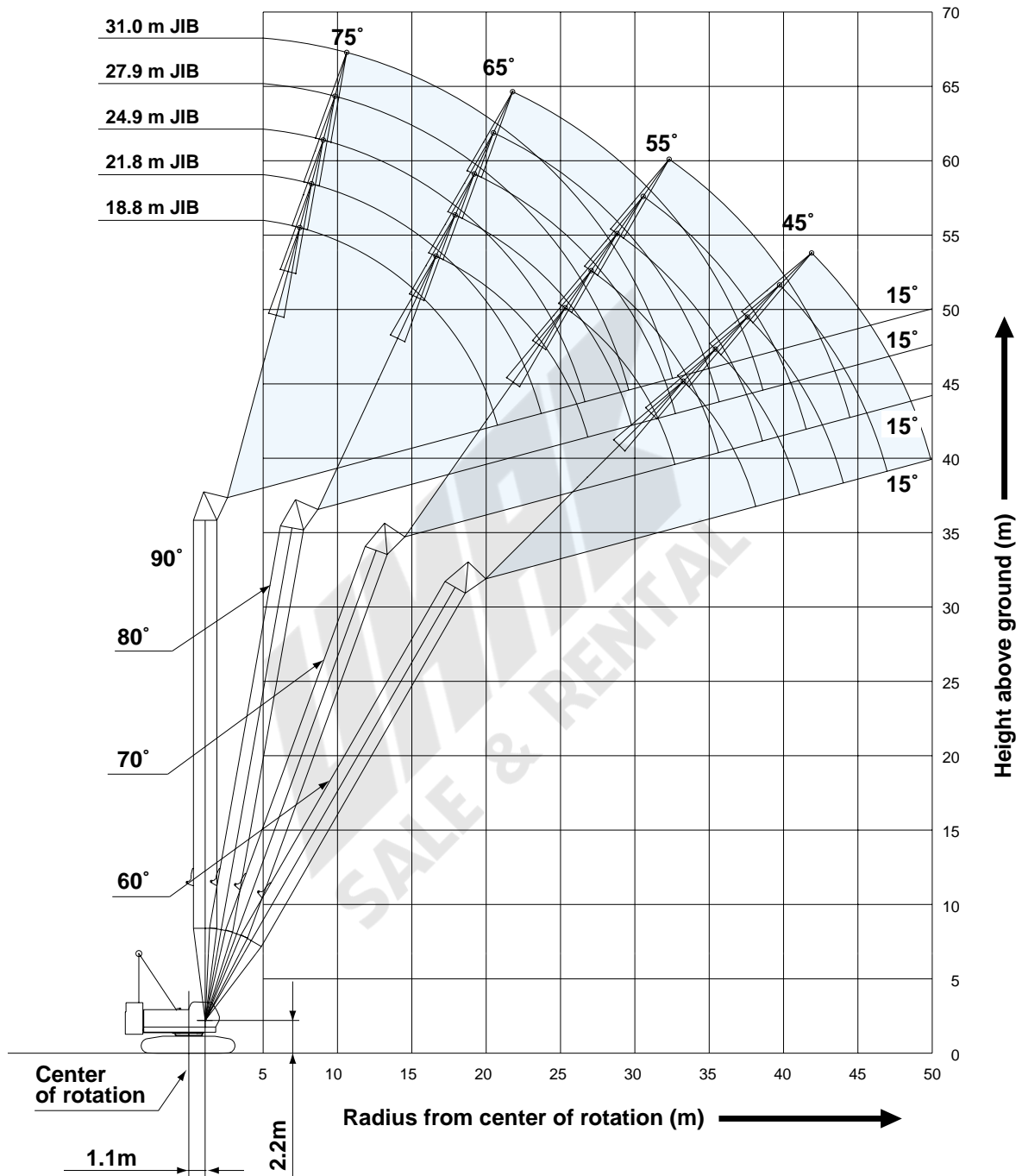

NOTES:

1. Ratings according to Japanese Construction Codes for Mobile Cranes and Japanese Safety Ordinance on Cranes, etc.
2. Ratings in metric tons for 360° working area.
3. Operating radius is the horizontal distance from center of rotation to a vertical line through the center of gravity of the load.
4. Weight of hook block(s), slings and other load handling accessories is included in rated load. Their total weight must be subtracted from rated load to obtain weight that can be lifted.
5. Ratings shown are based on freely suspended loads and make no allowance for such factors as wind effect on lifted load, ground condi-

- tions out-of-level, operating speeds or any other condition that could be detrimental to the safe operation of this equipment. Operator, therefore, has the responsibility to judge the existing conditions and reduce lifted loads and operating speeds accordingly.
6. Ratings are for operation on a firm and level surface.
7. At radii and boom lengths where no ratings are shown on chart, operation is not intended nor approved.
8. Tower/tower jib inserts and guy lines must be arranged as shown in the "Operator's Manual".
9. Tower jib hoist reeving is 8 part line.

Tower Length: 44.3 m

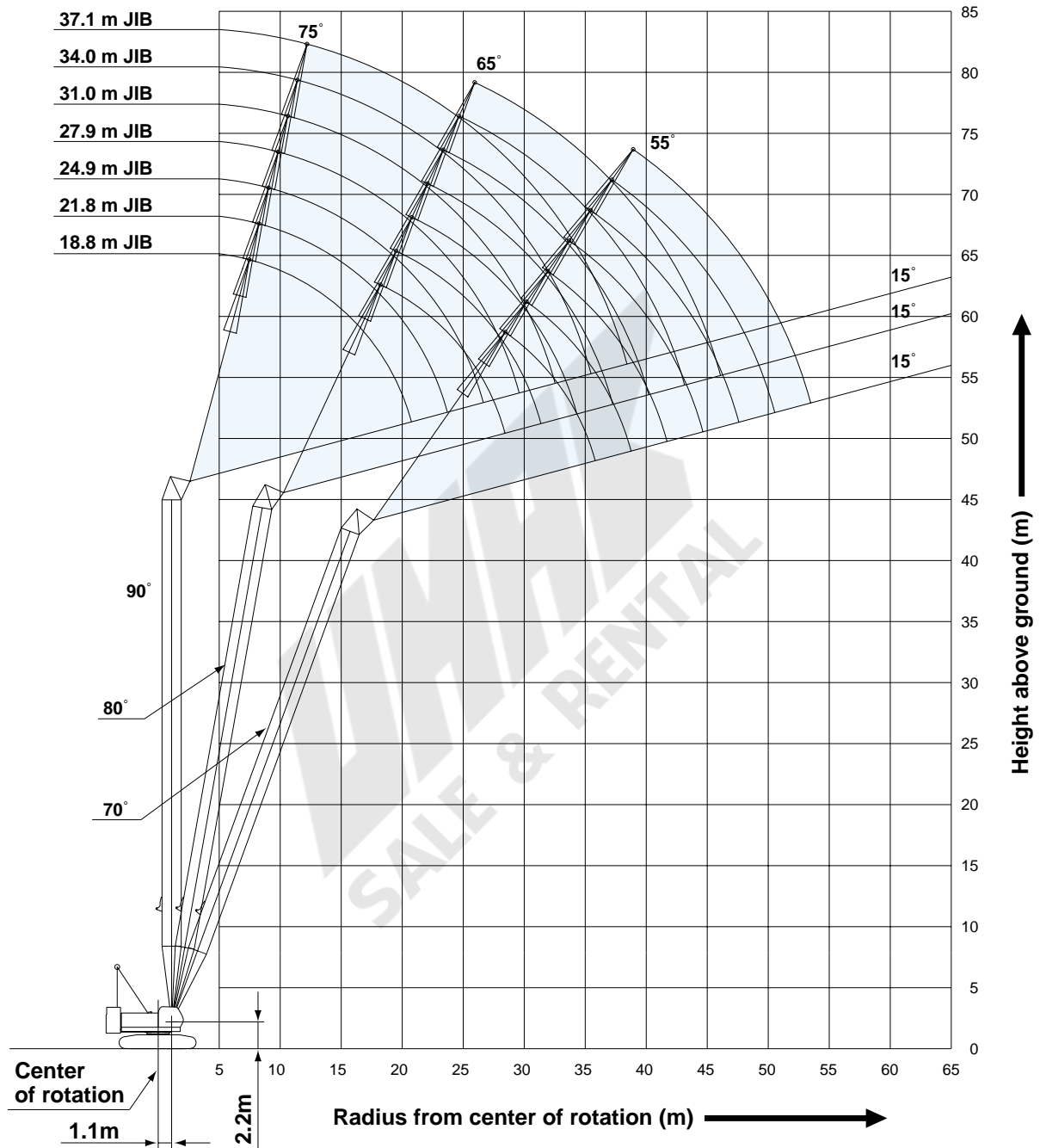

10. Gantry must be in raised position for all conditions.
11. Tower jib specifications require 1.6 ton additional counterweight for tower jib configuration.
12. Tower and tower jib backstops are required for all tower and tower jib combinations.
13. Crawler frames must be fully extended for all crane operations.
14. Ratings shown in are determined by the strength of the tower or other structural component.
15. With a 18.8 m tower jib, a 11-ton ball hook cannot be used.
16. With a 37.1 m tower jib, a 35-ton hook cannot be used.
17. When erecting or lowering the tower length of 41.2 m or over, the pillow plate for erection must be placed at the end of crawlers.
18. Instruction in the "Operator's Manual" must be strictly observed when operating the machine.
19. Tower jib ratings: Deduct weight of hook block, slings, and all other load handling accessories from tower jib ratings shown.



Tower Jib Lifting Capacities

Unit: metric ton

Counterweight: 34.3 t

26.0 m Tower Length	Tower length (m)		26.0								Tower length (m)	
	Jib length (m)		18.8				21.8				Jib length (m)	
	Tower angle		90°	80°	70°	60°	90°	80°	70°	60°	Tower angle	
Working radius (m)	7.7	15.0										7.7
	8.0	15.0					8.5m/15.0					8.0
	9.0	15.0					15.0					9.0
	10.0	15.0					15.0					10.0
	12.0	15.0					15.0					12.0
	14.0	15.0	15.2m/15.0				15.0					14.0
	16.0	13.7	14.9				13.7	16.5m/14.2				16.0
	18.0	11.9	12.9				11.8	12.8				18.0
	20.0	10.6	11.4				10.4	11.2				20.0
	22.0	20.5m/9.3	10.1	22.3m/8.8			9.2	10.0				22.0
	24.0		9.1	8.0			23.4m/7.8	9.0	7.9			24.0
	26.0		24.9m/8.5	7.4				8.1	7.2			26.0
	28.0			6.7	28.7m/5.6			27.9m/7.4	6.6			28.0
	30.0			29.3m/6.2	5.4				6.1	30.8m/5.0		30.0
	32.0				5.0				5.6	4.8		32.0
	34.0				33.3m/4.7				32.2m/5.5	4.5		34.0
	36.0									4.2		36.0
38.0									36.2m/4.1		38.0	
Reeves	2	2	2	2	2	2	2	2	2	2	Reeves	

29.1 m Tower Length	Tower length (m)		29.1										Tower length (m)			
	Jib length (m)		18.8				21.8				24.9				Jib length (m)	
	Tower angle		90°	80°	70°	60°	90°	80°	70°	60°	90°	80°	70°	60°	Tower angle	
Working radius (m)	7.7	15.0													7.7	
	8.0	15.0					8.5m/15.0								8.0	
	9.0	15.0					15.0				9.3m/15.0				9.0	
	10.0	15.0					15.0				15.0				10.0	
	12.0	15.0					15.0				15.0				12.0	
	14.0	15.0	15.7m/14.9				15.0				15.0				14.0	
	16.0	13.7	14.7				13.7	17.0m/13.4			13.6				16.0	
	18.0	11.9	12.7				11.8	12.6			11.8	18.3m/12.1			18.0	
	20.0	10.4	11.2				10.4	11.0			10.3	10.9			20.0	
	22.0	20.5m/9.4	9.9	23.3m/7.9			9.2	9.8			9.2	9.8			22.0	
	24.0		8.9	7.7			23.4m/8.0	8.8	25.0m/7.1		8.3	8.8			24.0	
	26.0		25.5m/8.1	7.1				8.0	6.8		7.5	8.0	26.8m/6.4		26.0	
	28.0			6.4				7.3	6.3		26.3m/6.9	7.3	6.1		28.0	
	30.0			5.9	30.2m/4.9			28.4m/7.0	5.8			6.7	5.7		30.0	
	32.0			30.3m/5.7	4.6				5.3	32.3m/4.3		31.4m/6.1	5.3		32.0	
	34.0				4.3				33.2m/5.0	4.1			4.9	34.5m/3.9	34.0	
	36.0				34.8m/4.1					3.9			4.5	3.7	36.0	
38.0									37.7m/3.6			36.2m/4.4	3.5	38.0		
40.0													3.3	40.0		
42.0													40.7m/3.2	42.0		
Reeves	2	2	2	2	2	2	2	2	2	2	2	2	2	Reeves		

Note:

Ratings according to Japanese Construction Codes for Mobile Cranes and Japanese Safety Ordinance on Cranes, etc.

Ratings shown in are determined by the strength of the tower or other structural components.

Refer to notes P17 and P18.

HYDRAULIC CRAWLER CRANE

7090

Unit: metric ton

Counterweight: 34.3 t

32.1 m Tower Length	32.1																	Tower length (m)	
	Jib length (m)																	Jib length (m)	
	18.8				21.8				24.9				27.9				Tower angle		
Working radius (m)	90°	80°	70°	60°	90°	80°	70°	60°	90°	80°	70°	60°	90°	80°	70°	60°	90°	80°	
7.7	15.0																		7.7
8.0	15.0				8.5m/15.0														8.0
9.0	15.0				15.0				9.3m/15.0										9.0
10.0	15.0				15.0				15.0				10.1m/15.0						10.0
12.0	15.0				15.0				15.0				15.0						12.0
14.0	15.0				15.0				15.0				15.0						14.0
16.0	13.8	16.3m/14.0			13.7	17.6m/12.6			13.7				13.6						16.0
18.0	11.9	12.4			11.9	12.3			11.8	18.9m/11.5			11.7						18.0
20.0	10.4	10.9			10.4	10.8			10.4	10.7			10.3	20.1m/10.5					20.0
22.0	20.5m/9.6	9.7			9.2	9.6			9.2	9.6			9.1	9.4					22.0
24.0		8.7	24.3m/7.1		23.4m/8.1	8.6			8.3	8.7			8.2	8.6					24.0
26.0		7.9	6.6			7.8	26.1m/6.4		7.5	7.8	27.8m/5.8		7.4	7.7					26.0
28.0			6.1			7.1	5.9		26.3m/7.0	7.2	5.8		6.8	7.1	29.6m/5.3				28.0
30.0			5.6	31.7m/4.3		29.0m/6.7	5.5			6.6	5.4		29.3m/6.0	6.5	5.2				30.0
32.0			31.3m/5.2	4.3			5.1	33.9m/3.7		31.9m/6.0	5.0			6.0	4.9				32.0
34.0				3.9			4.7	3.7			4.6			5.5	4.5				34.0
36.0				3.6			34.3m/4.6	3.5			4.3	3.4		34.8m/5.3	4.2				36.0
38.0				36.3m/3.5				3.3			37.2m/4.0	3.2			3.9	38.2m/3.0			38.0
40.0								39.3m/3.1				3.0			3.6	2.9			40.0
42.0												2.8			40.2m/3.5	2.7			42.0
44.0												42.2m/2.6				2.5			44.0
46.0															45.1m/2.2				46.0
Reeves	2	2	2	2	2	2	2	2	2	2	2	2	2	2	2	2	2	2	Reeves

35.2 m Tower Length	35.2																	Tower length (m)			
	Jib length (m)																	Jib length (m)			
	18.8				21.8				24.9				27.9				31.0				Tower angle
Working radius (m)	90°	80°	70°	60°	90°	80°	70°	60°	90°	80°	70°	60°	90°	80°	70°	60°	90°	80°			
7.7	15.0																		7.7		
8.0	15.0				8.5m/15.0														8.0		
9.0	15.0				15.0				9.3m/15.0										9.0		
10.0	15.0				15.0				15.0				10.1m/15.0				10.9m/13.5		10.0		
12.0	15.0				15.0				15.0				15.0				13.5		12.0		
14.0	15.0				15.0				15.0				15.0				13.5		14.0		
16.0	13.8	16.8m/13.2			13.7				13.7				13.6				13.5		16.0		
18.0	11.9	12.2			11.9	18.1m/12.0			11.8	19.4m/10.9			11.7				11.7		18.0		
20.0	10.4	10.7			10.4	10.6			10.4	10.5			10.3	20.7m/9.9			10.2		20.0		
22.0	20.5m/9.6	9.6			9.3	9.6			9.2	9.5			9.2	9.2			9.1	9.1	22.0		
24.0		8.6	25.4m/6.5		23.4m/8.2	8.6			8.3	8.5			8.2	8.4			8.2	8.2	24.0		
26.0		7.8	6.3			7.8	27.1m/5.8		7.5	7.7			7.4	7.6			7.4	7.5	26.0		
28.0		26.5m/7.4	5.9			7.1	5.6		26.3m/7.0	7.0	28.9m/5.3		6.8	6.9			6.7	6.9	28.0		
30.0			5.4			29.5m/6.4	5.3			6.4	5.1		29.3m/6.0	6.3	30.6m/4.8		6.2	6.3	30.0		
32.0			4.9	33.2m/3.6			4.8			5.9	4.8			5.8	4.5		5.7	5.8	32.4m/4.3	32.0	
34.0			32.4m/4.8	3.6			4.5	35.4m/3.2		32.4m/5.7	4.4			5.4	4.3		32.2m/5.3	5.3	4.1	34.0	
36.0				3.4			35.3m/4.2	3.2			4.1	37.5m/2.9		35.4m/5.0	4.0			5.0	3.9	36.0	
38.0				37.8m/3.1				3.0			3.8	2.9			3.7	39.7m/2.5		4.6	3.6	38.0	
40.0								2.8			38.3m/3.7	2.7			3.4	2.5		38.3m/4.5	3.4	41.9m/2.1	40.0
42.0								40.8m/2.6				2.5			41.2m/3.2	2.3			3.1	2.1	42.0
44.0												43.7m/2.3				2.1			2.9	1.9	44.0
46.0																1.9			44.2m/2.9	1.8	46.0
48.0																46.7m/1.8				1.7	48.0
Reeves	2	2	2	2	2	2	2	2	2	2	2	2	2	2	2	2	2	2	2	2	Reeves

Note:

Ratings according to Japanese Construction Codes for Mobile Cranes and Japanese Safety Ordinance on Cranes, etc.

Ratings shown in are determined by the strength of the tower or other structural components.

Refer to notes P17 and P18.

Unit: metric ton

Counterweight: 34.3 t

38.2 m Tower Length	38.2																Tower length (m)	
	18.8				21.8				24.9				27.9				Jib length (m)	
	Tower angle	90°	80°	70°	60°	90°	80°	70°	60°	90°	80°	70°	60°	90°	80°	70°	60°	Tower angle
Working radius (m)	7.7	15.0																7.7
	8.0	15.0			8.5m/15.0													8.0
	9.0	15.0			15.0				9.3m/15.0									9.0
	10.0	15.0			15.0				15.0				10.1m/15.0					10.0
	12.0	15.0			15.0				15.0				15.0					12.0
	14.0	15.0			15.0				15.0				15.0					14.0
	16.0	13.8	17.3m/12.5		13.8				13.7				13.6					16.0
	18.0	11.9	12.0		11.9	18.6m/11.3			11.8	19.9m/10.3			11.8					18.0
	20.0	10.5	10.5		10.4	10.4			10.4	10.3			10.3	21.2m/9.4				20.0
	22.0	20.5m/9.7	9.3		9.3	9.3			9.2	9.2			9.2	9.0				22.0
	24.0		8.4		23.4m/8.2	8.4			8.3	8.3			8.2	8.2				24.0
	26.0		7.6	26.4m/5.8		7.6			7.5	7.5			7.4	7.4				26.0
	28.0		27.1m/7.1	5.4		6.9	28.2m/5.2		26.3m/7.1	6.9	29.9m/4.8		6.8	6.8				28.0
	30.0			5.1		6.3	4.8			6.3	4.8		29.3m/6.1	6.2	31.7m/4.4			30.0
	32.0			4.7			4.6			5.8	4.4			5.7	4.3			32.0
	34.0			33.4m/4.3	34.8m/3.0		4.2			33.0m/5.5	4.1			5.3	4.0			34.0
	36.0				2.9		3.9	36.9m/2.5			3.8			35.9m/4.9	3.7			36.0
	38.0				2.7		36.4m/3.8	2.5			3.5	39.1m/2.2			3.4			38.0
	40.0				39.4m/2.4			2.3			39.3m/3.3	2.2			3.2	41.2m/1.8		40.0
	42.0							2.1				2.0			3.0	1.8		42.0
	44.0							42.3m/1.9				1.8			42.3m/2.9	1.5		44.0
	46.0											45.2m/1.5						46.0
	Reeves	2	2	2	2	2	2	2	2	2	2	2	2	2	2	2	2	Reeves

Working radius (m)	38.2							Tower length (m)
	31.0			34.0				Jib length (m)
	Tower angle	90°	80°	70°	90°	80°	70°	Tower angle
Working radius (m)	10.0	10.9m/13.5			11.7m/11.5			10.0
	12.0	13.5			11.5			12.0
	14.0	13.5			11.5			14.0
	16.0	13.5			11.5			16.0
	18.0	11.7			11.5			18.0
	20.0	10.3			10.2			20.0
	22.0	9.1	22.5m/8.6		9.1	23.8m/7.9		22.0
	24.0	8.2	8.0		8.1	7.9		24.0
	26.0	7.4	7.3		7.3	7.2		26.0
	28.0	6.7	6.7		6.7	6.6		28.0
	30.0	6.2	6.1		6.1	6.0		30.0
	32.0	5.7	5.6	33.4m/4.0	5.6	5.6		32.0
	34.0	32.2m/5.6	5.2	3.9	5.2	5.1	35.2m/3.6	34.0
	36.0		4.8	3.6	35.2m/4.6	4.8	3.5	36.0
	38.0		4.5	3.4		4.4	3.3	38.0
	40.0		38.8m/4.3	3.1		4.1	3.0	40.0
	42.0			2.9		41.8m/3.8	2.8	42.0
	44.0			2.7			2.6	44.0
	46.0			45.2m/2.5			2.5	46.0
	48.0						2.3	48.0
	50.0					48.2m/2.2		50.0
	Reeves	2	2	2	2	2	2	Reeves

Note:

Ratings according to Japanese Construction Codes for Mobile Cranes and Japanese Safety Ordinance on Cranes, etc.

Ratings shown in are determined by the strength of the tower or other structural components.

Refer to notes P17 and P18.

HYDRAULIC CRAWLER CRANE

7090

Unit: metric ton Counterweight: 34.3 t

41.2 m Tower Length	41.2																						
	Tower length (m)		18.8						21.8				24.9			27.9			31.0			Tower length (m)	
	Jib length (m)	Tower angle	90°	80°	70°	60°	90°	80°	70°	60°	90°	80°	70°	90°	80°	70°	90°	80°	70°	Jib length (m)	Tower angle		
Working radius (m)	7.7	15.0																			7.7		
	8.0	15.0					8.5m/15.0														8.0		
	9.0	15.0					15.0						9.3m/15.0								9.0		
	10.0	15.0					15.0						10.1m/15.0				10.9m/13.5				10.0		
	12.0	15.0					15.0						15.0				13.5				12.0		
	14.0	15.0					15.0						15.0				13.5				14.0		
	16.0	13.8	17.9m/11.8				13.8						13.7				13.6				16.0		
	18.0	11.9	11.7				11.9	19.2m/10.7					11.8				11.8				18.0		
	20.0	10.5	10.3				10.4	10.2					10.4	20.4m/9.7		10.3	21.7m/8.9			10.3	20.0		
	22.0	20.5m/9.8	9.1				9.3	9.1					9.2	8.9		9.2	8.8			9.1	23.0m/8.2	22.0	
	24.0		8.2				23.4m/8.3	8.2					8.3	8.1		8.2	8.0			8.2	7.8	24.0	
	26.0		7.4	27.5m/5.4				7.4					7.5	7.4		7.4	7.3			7.4	7.2	26.0	
	28.0		27.6m/6.7	5.2				6.8	29.2m/4.9				26.3m/7.1	6.7		6.8	6.6			6.7	6.5	28.0	
	30.0			4.8				6.2	4.7				6.2	31.0m/4.4		29.3m/6.1	6.1			6.2	6.0	30.0	
	32.0			4.4				30.5m/6.0	4.3				5.7	4.2		5.6	32.7m/4.0			5.7	5.5	32.0	
	34.0			4.1					4.0					33.5m/5.2	3.9		5.1	3.8		32.2m/5.6	5.1	34.5m/3.6	34.0
	36.0				34.5m/3.9	36.3m/2.4			3.7					3.6		4.8	3.5				4.7	3.4	36.0
	38.0					2.3			37.4m/3.4	38.4m/2.0				3.3		36.4m/4.6	3.2				4.4	3.1	38.0
	40.0					2.1				1.9				3.1			3.0				39.4m/4.1	2.9	40.0
	42.0					40.9m/1.9				1.7				40.4m/3.0			2.8					2.7	42.0
44.0									43.8m/1.6							43.3m/2.5					2.5	44.0	
46.0																					2.3	46.0	
48.0																					46.2m/2.2	48.0	
Reeves	2	2	2	2	2	2	2	2	2	2	2	2	2	2	2	2	2	2	2	2	2	Reeves	

Tower length (m)		41.2						Tower length (m)			
Jib length (m)	Tower angle	90°	80°	70°	90°	80°	70°	Jib length (m)	Tower angle		
Working radius (m)	10.0	11.7m/11.5							10.0		
	12.0	11.5						12.5m/9.5	12.0		
	14.0	11.5						9.5	14.0		
	16.0	11.5						9.5	16.0		
	18.0	11.5						9.4	18.0		
	20.0	10.2						9.1	20.0		
	22.0	9.1						8.7	22.0		
	24.0	8.1	24.3m/7.5					8.2	25.9m/7.1	24.0	
	26.0	7.3	6.9					7.4	7.0	26.0	
	28.0	6.7	6.4					6.7	6.3	28.0	
	30.0	6.1	5.9					6.2	5.8	30.0	
	32.0	5.6	5.4					5.7	5.3	32.0	
	34.0	5.2	5.0					5.2	4.9	34.0	
	36.0	35.2m/4.6	4.6	36.2m/3.3				4.9	4.5	36.0	
	38.0		4.3	3.0				4.5	4.2	38.4m/2.9	38.0
	40.0		4.0	2.8				38.1m/4.4	3.9	2.7	40.0
	42.0		3.7	2.6					3.7	2.4	42.0
	44.0		42.3m/3.7	2.4					3.4	2.2	44.0
	46.0			2.2					45.3m/3.2	2.1	46.0
	48.0			2.0						1.9	48.0
50.0			49.2m/1.9						1.7	50.0	
52.0									1.6	52.0	
Reeves	2	2	2	1	1	1				Reeves	

Note:
 Ratings according to Japanese Construction Codes for Mobile Cranes and Japanese Safety Ordinance on Cranes, etc.
 Ratings shown in are determined by the strength of the tower or other structural components.
 Refer to notes P17 and P18.

Unit: metric ton

Counterweight: 34.3 t

44.3 m Tower Length	44.3																		
	Tower length (m)	44.3															Tower length (m)		
	Jib length (m)	18.8					21.8			24.9			27.9			31.0			Jib length (m)
	Tower angle	90°	80°	70°	90°	80°	70°	90°	80°	70°	90°	80°	70°	90°	80°	70°	Tower angle		
7.7	15.0																7.7		
8.0	15.0				8.5m/15.0												8.0		
9.0	15.0				15.0			9.3m/15.0									9.0		
10.0	15.0				15.0			15.0			10.1m/15.0			10.9m/13.5			10.0		
12.0	15.0				15.0			15.0			15.0			13.5			12.0		
14.0	15.0				15.0			15.0			15.0			13.5			14.0		
16.0	13.8				13.8			13.7			13.6			13.5			16.0		
18.0	11.9	18.4m/11.1			11.9	19.7m/10.1		11.9			11.8			11.7			18.0		
20.0	10.5	10.1			10.4	9.9		10.4	21.0m/9.2		10.3			10.3			20.0		
22.0	20.5m/9.8	9.1			9.3	8.9		9.2	8.7		9.2	22.3m/8.4		9.1	23.5m/7.8		22.0		
24.0		8.1			23.4m/8.3	8.0		8.3	7.9		8.2	7.7		8.2	7.6		24.0		
26.0		7.4				7.3		7.5	7.2		7.5	7.1		7.4	7.0		26.0		
28.0		6.7	28.5m/4.8			6.6		26.3m/7.1	6.6		6.8	6.4		6.7	6.4		28.0		
30.0		28.1m/6.6	4.5			6.1	30.3m/4.3			6.0		29.3m/6.1	5.9		6.2	5.8	30.0		
32.0			4.2			31.1m/5.7	4.0		5.5	3.9		5.4	33.8m/3.5	5.7	5.4		32.0		
34.0			3.8				3.7		5.1	3.6		5.0	3.5	32.2m/5.6	5.0	35.5m/3.2	34.0		
36.0			35.5m/3.5				3.4			3.4		4.6	3.2		4.6	3.1	36.0		
38.0							3.2			3.1		37.0m/4.4	3.0		4.3	2.9	38.0		
40.0							38.5m/3.1			2.9			2.8		39.9m/4.0	2.7	40.0		
42.0										41.4m/2.5			2.6			2.4	42.0		
44.0													2.3			2.2	44.0		
46.0													44.3m/2.1			2.1	46.0		
48.0																47.3m/1.8	48.0		
Reeves	2	2	2	2	2	2	2	2	2	2	2	2	2	2	2	2	Reeves		

Working radius (m)	44.3																
	Tower length (m)	44.3															Tower length (m)
	Jib length (m)	34.0					37.1									Jib length (m)	
	Tower angle	90°	80°	70°	90°	80°	70°	Tower angle			Tower angle						
10.0	11.7m/11.5																10.0
12.0	11.5				12.5m/9.5												12.0
14.0	11.5				9.5												14.0
16.0	11.5				9.5												16.0
18.0	11.5				9.4												18.0
20.0	10.2				9.0												20.0
22.0	9.1				8.7												22.0
24.0	8.1	24.8m/7.1			8.2												24.0
26.0	7.3	6.7			7.4	26.5m/6.7											26.0
28.0	6.7	6.3			6.7	6.2											28.0
30.0	6.1	5.7			6.2	5.6											30.0
32.0	5.6	5.3			5.7	5.2											32.0
34.0	5.2	4.9			5.3	4.8											34.0
36.0	35.2m/4.7	4.5	37.3m/2.8		4.9	4.4											36.0
38.0		4.2	2.7		4.5	4.1	39.4m/2.4										38.0
40.0		3.9	2.5		38.1m/4.4	3.8	2.3										40.0
42.0		3.6	2.3			3.6	2.1										42.0
44.0		42.8m/3.5	2.1			3.3	2.0										44.0
46.0			2.0			45.8m/3.1	1.8										46.0
48.0			1.8				1.6										48.0
50.0			1.6														50.0
Reeves	2	2	2	1	1	1											Reeves

Note:

Ratings according to Japanese Construction Codes for Mobile Cranes and Japanese Safety Ordinance on Cranes, etc.
Ratings shown in [] are determined by the strength of the tower or other structural components.

Refer to notes P17 and P18.

PARTS AND ATTACHMENTS

Base Machine

Weight: 55,210 kg Width: 3,500 mm

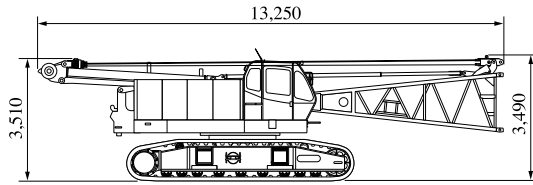

Base Machine

Without crawler
Weight: 34,790 kg Width: 3,200 mm

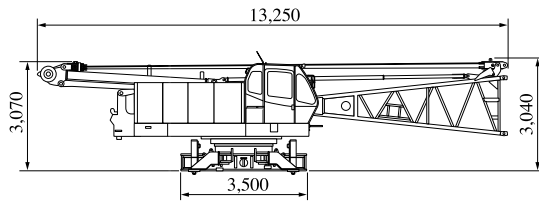

Crawler

Weight: 10,200 kg

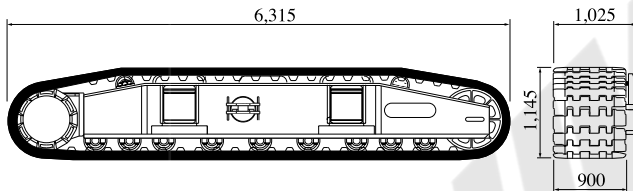

Gantry

Weight: 1,400 kg

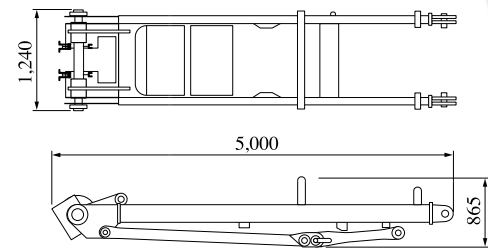

Counterweight A

Weight: 10,000 kg

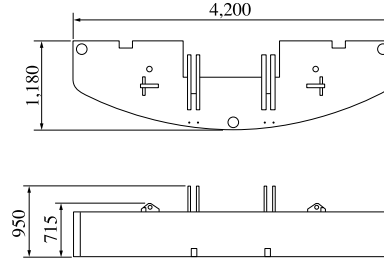

Counterweight B, C

Weight: 7,500 kg x 2 pieces

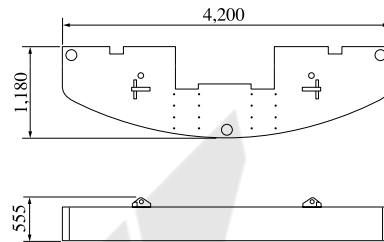

Counterweight D

Weight: 3,800 kg

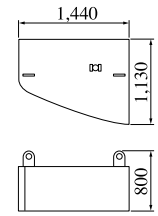

Counterweight E

Weight: 4,000 kg

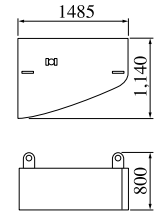

Counterweight F (for tower)

Weight: 780 kg

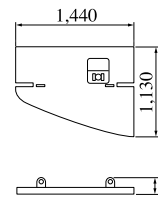

Counterweight G (for tower)

Weight: 810 kg

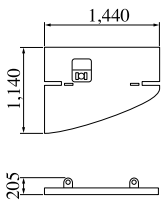

Insert Boom

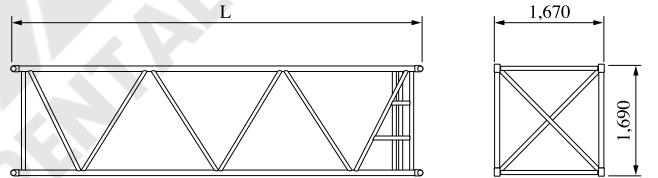

	L (mm)	Weight (kg)*
3.0m	3,170	480
6.1m	6,210	780
9.1m	9,260	1,080

*with boom guy cables

Boom Base

Weight: 1,580 kg

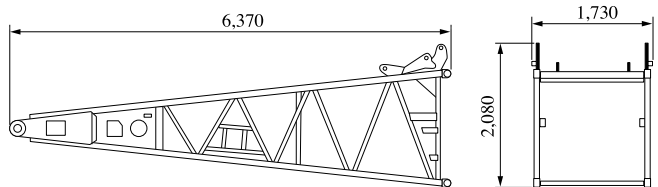

Boom Top

Weight: 1,830 kg (with boom guy cables)

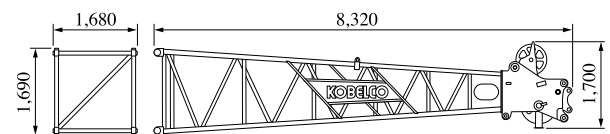

Dimensions: mm Weight: kg

Jib Top (For Crane)

Weight: 280 kg

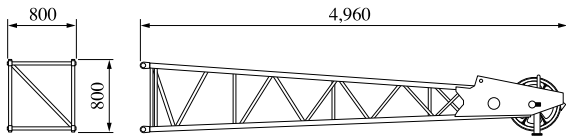

Tower Jib Top

Weight: 560 kg

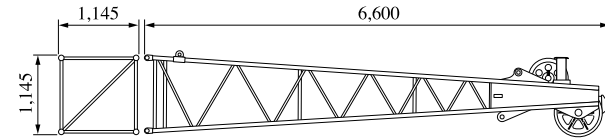

Jib Base

Weight: 200 kg

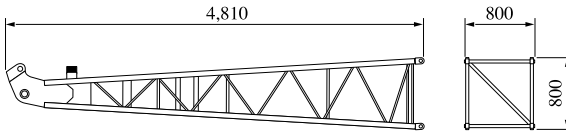

Tower Jib Base

Weight: 1,060 kg

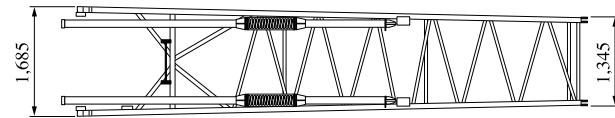

Tower Cap

Weight: 1,220 kg

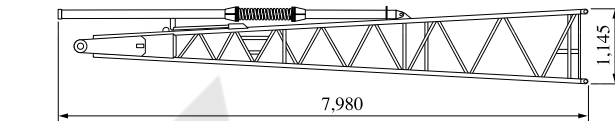
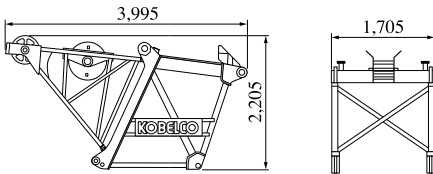

Tower Jib Strut

Weight: 1,090 kg

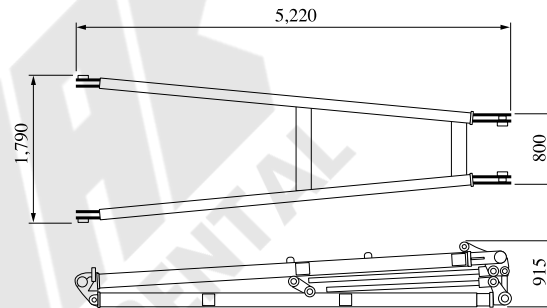

Other Attachments

Attachments	Weight	Dimensions (L x W x H)
9.1 m insert boom with lug (9.1A)	1,100 kg (with guy cables)	9,260 mm x 1,670 mm x 1,810 mm
9.1 m special insert boom for tower (9.1B)	1,460 kg (with guy cables)	9,260 mm x 1,680 mm x 2,505 mm
6.1 m insert jib (for crane)	180 kg	6,175 mm x 1,180 mm x 1,145 mm
3.0 m tower insert jib	180 kg	3,125 mm x 1,180 mm x 1,145 mm
6.1 m tower insert jib	320 kg	6,175 mm x 1,180 mm x 1,145 mm
9.1 m tower insert jib	460 kg	9,220 mm x 1,180 mm x 1,145 mm
Jib strut (for crane)	250 kg	3,620 mm x 835 mm x 615 mm
Backstop (for crane)	130 kg (1 piece)	4,900 mm x 145 mm dia.
Backstop (for tower)	380 kg (1 piece)	5,000 mm x 140 mm dia.
Upper spreader	300 kg	1,780 mm x 305 mm x 800 mm
Lower spreader	200 kg	905 mm x 255 mm x 710 mm
Upper spreader for tower jib	300 kg	780 mm x 735 mm x 1,175 mm
Lower spreader for tower jib	370 kg	1,655 mm x 465 mm x 1,060 mm
90-ton hook	1,300 kg	700 mm x 530 mm x 1,890 mm
50-ton hook	850 kg	700 mm x 430 mm x 1,680 mm
35-ton hook	700 kg	700 mm x 470 mm x 1,575 mm
Ball hook	300 kg	360 mm dia. x 1,050 mm

Note: Estimated weights may vary ± 2%.

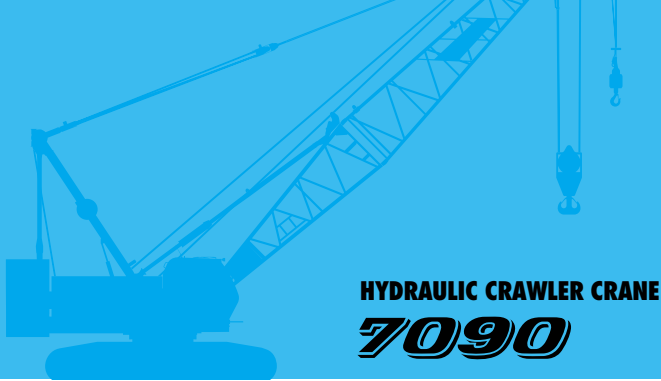

HYDRAULIC CRAWLER CRANE
7090

Standard Equipment

Upper Structure/Lower Structure

Counterweight: 32.8 ton (total weight)
 900 mm shoe crawlers
 Batteries (2-12V, 136 Ah/5HR)
 Trans-lifter (jack system)
 Gantry raising/lowering cylinder
 Electric hand throttle grip
 Variable boom hoist speed controller
 Variable main/aux. hoist speed controller
 Swing neutral-free/brake select switch
 Side deck for cab
 Steps (crawlers)
 Two front working lights
 Two rear view mirrors
 Mirror for monitoring drums
 Tools (for routine maintenance)
 Upper spreader storage guide

Cab/Control

Air conditioner
 Luggage box
 Cup holder
 Ashtray
 Cigar lighter
 Intermittent wiper & window washer (skylight and front window)
 Sun visor
 Roof blind
 Floor mat (cloth)
 Foot rest
 Shoe tray

Safety Device

Load Moment Indicator (with boom lowering slow stop function)
 LMI release key (for hook over-hoist prevention device and boom over-hoist prevention device)
 LCD multi display
 Ultimate stop function for boom over-hoist
 Function lock lever
 Propel lever lock
 Mechanical drum lock pawl (main, aux. and boom hoist)
 Signal horn
 Swing parking brake
 Mechanical swing lock pin (four positions)
 Swing flashers/warning buzzer

Note: Standard equipment may vary depending on your areas or countries.
 Due to our policy of continual product improvements all designs and specifications are subject to change without advance notice.
 Copyright by KOBELCO CRANES CO., LTD. No part of this catalog may be reproduced in any manner without notice.

KOBELCO CRANES CO., LTD.

17-1, Higashigotanda 2-chome, Shinagawa-ku, Tokyo 141-8626 JAPAN
 Tel: +81-3-5789-2130 Fax: +81-3-5789-3372

Inquiries To:

KOBELCO is the corporate mark used by Kobe Steel on a variety of products and in the names of a number of Kobe Steel Group companies.