

**HYDRAULIC CRAWLER CRANE**

**KOBELCO**

**7080-2** *MasterTech*

**Max. Lifting Capacity: 90 Tons at 3.7 Meters**

**Max. Boom Length: 57.9 Meters**

**Max. Luffing Tower Lifting Capacity: 15 Tons at 14.0 Meters**

**Max. Tower + Tower Jib Length: 44.2 + 35.1 Meters**

## Specifications

- **Max. 100m/min line speed cuts cycle times.**
- **Long-outreach lifting allows max. working radius of 54m x 1.5 tons. (Fixed jib specification)**
- **Selectable neutral-free or neutral-brake swing modes to suit task.**
- **Dial setting for drum speed simplifies multiple control.**
- **3-piece stacking counterweight for easier transportation.**

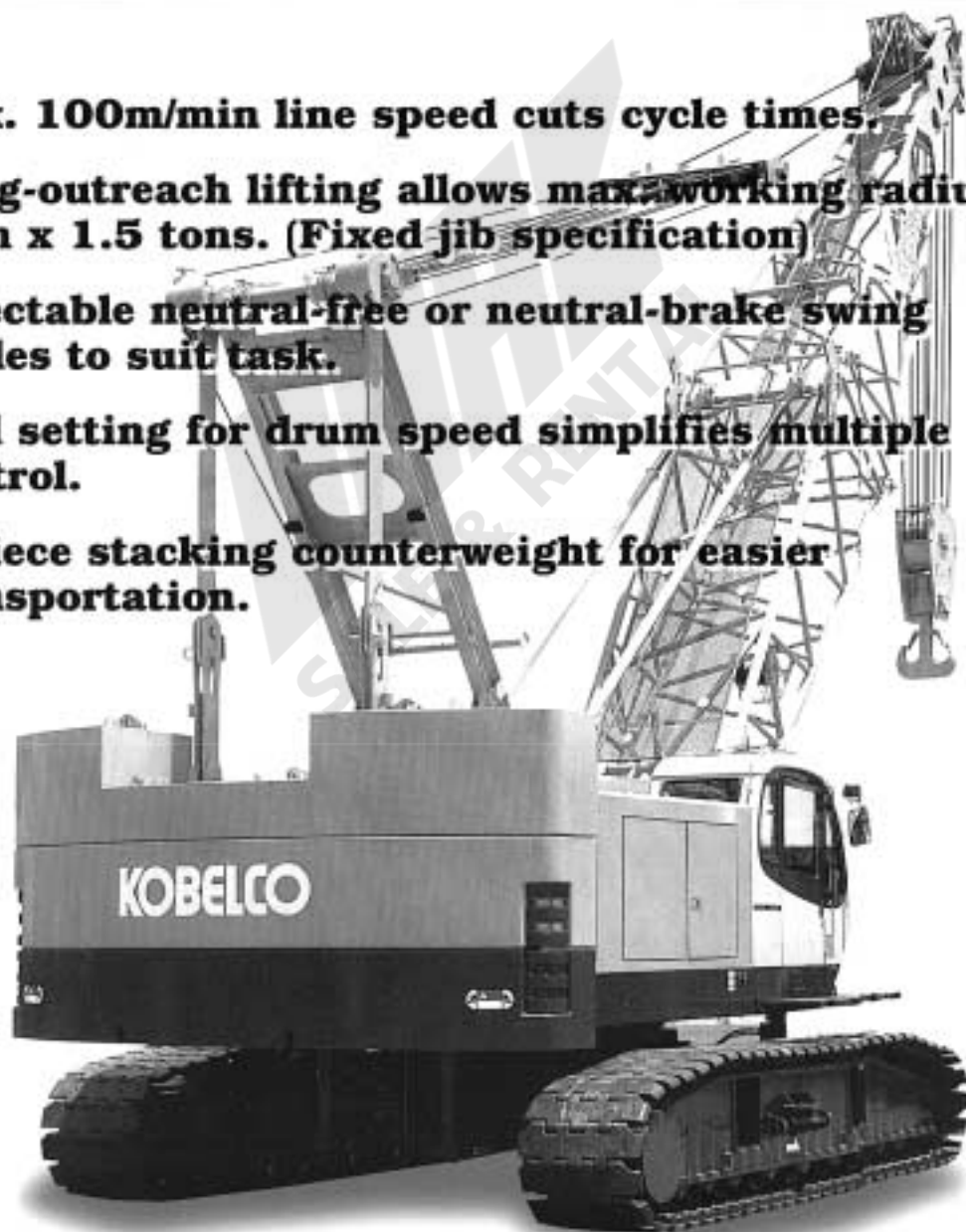

# Configuration & Style of Attachment

## Std. Crawler Crane

**Max. Lifting Capacity:**

**90 metric ton x 3.7 m**

**Boom Length:**

**12.2 m to 57.9 m**

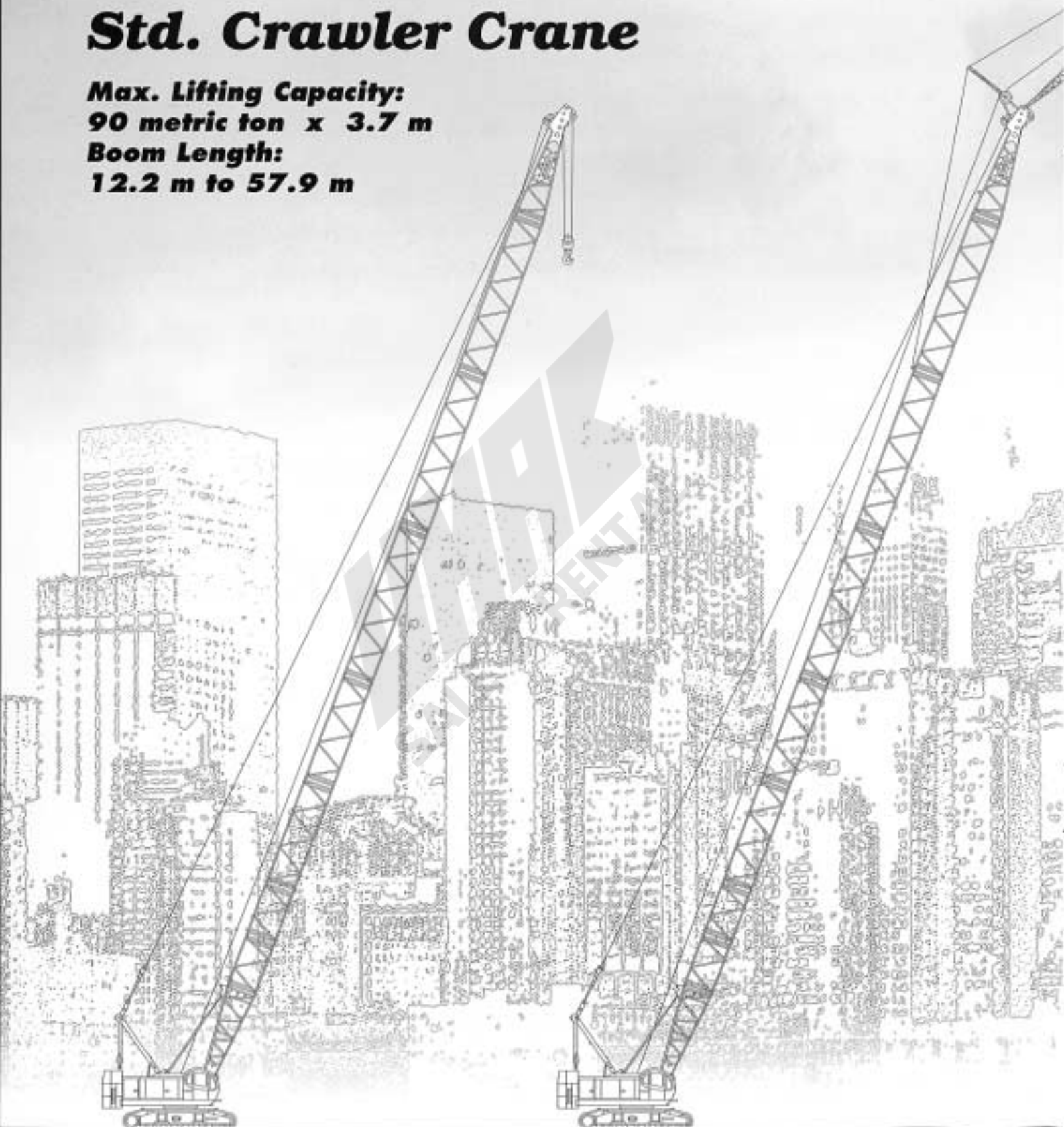



## **Fixed Jib**

**Max. Lifting Capacity:**  
**11 metric ton x 16.0 m**  
**Max. Boom Length**  
**+ Jib Length:**  
**51.8 m + 21.3 m**



## **Luffing Tower**

**Max. Lifting Capacity:**  
**15 metric ton x 14.0 m**  
**Max. Tower Length + Jib Length**  
**44.2 m + 35.1 m**

# Features

---

## Overall Features

- **100m/min line speed:** High-speed hoisting boosts operating efficiency in high-rise steel frame construction.
- **Largest working radius in class:** Allows a long reach from a close-up position, for a more versatile working performance.
- **Newly designed crawlers:** Gives greater stability equalized in all directions, to improve lifting efficiency.
- **3 control modes for swing:** Select neutral-free at high or low speed, or neutral-brake mode, according to task in hand.
- **Dial-type control system for line speed:** Simplifies horizontal movement of lifted loads.
- **Easy assembly/disassembly:** Safer, more efficient, and cuts transportation costs.

## Operations

- Well balanced, low center of gravity design.
- Boom designed for simple switch between crane and luffing tower use.
- **Mechatronic ESS:** Maintains high engine power while saving fuel.
- **Wide, large capacity drums:** Large winding capacity on first layer benefits clamshell operations.

## Controls

- **Low speed swing control device:** (for low speed neutral-free or neutral-brake swing modes) Features low speed swing matched to engine rpm.
- **Hoist reaction/drum rotation sensing system:** Can be sensed through the 'feel' of lever grip. (opt.)
- **Swing power modes:** Swing power can be selected to suit task in hand.
- Hydraulic pilot with rebound sensing control for swing.
- Inching control mechanism for hoist, boom hoist and travel.
- Electric throttle lever control
- Electric throttle pedal control (optional)
- Inching control switch positioned on lever grip.

## Transport & Maintenance

- **Tower jib spreader:** With insert tower, for easier jib assembly.
- **3-piece stacking counterweight:** Can be transported by 11 ton trailer, and loaded with other component.

- **Self-erecting boom:** Eliminates need for troublesome mid-point boom guy-lines.
- **Servicing diagnostic display (check & safety monitor):** Indicates status of electrical and hydraulic circuits, and engine condition.
- **Trans-Lifter (optional):** Trans-Lifter system allows quick and easy crawler side frame removal and trailer loading. Four vertical cylinders lift up the basic machine for self loading onto trailer. Two horizontal cylinders facilitate side frames for removal/replacement.

## Safety

- **Overload prevention device with boom/tower jib lowering slow stop:** Boom lowering stops smoothly, preventing dangerous swaying of load.
- **Free fall lock:** Activation of lock prevents free fall even in neutral free mode.
- **Free fall lock mechanism:** Requires use of key to release lock and operate free fall.
- **Separate valve for brake circuit** installed for added safety.
- **Swing flashers and warning buzzer** alert site personnel during swing.
- **Rear working lights** simplify checking to rear during nighttime operations.
- **Safety lever lock** obstructs exit from cab until engaged.
- Locks supplied for individual levers.
- **Overload auto-stop release device** allows canceling of separate functions.

## Comfort

- **Rigorous noise reduction measures** meet standards for low noise construction machine classification (70dB(A) at 7m).
- **Sophisticated body design and discreet color** suit urban environments.
- **Non-CFC air conditioner** with fresh air vents installed as standard.
- **Non-asbestos brake/clutch linings** eliminate environmental contamination.
- **Tilt-adjustable upholstered seat**
- **Intermittent wipers with washers** for lower/upper front windows and skylight
- **Removable foot rest**, large mud-removing step

# Specifications

# 7080-2

## Upper Machinery



### Power Plant

**Model** ..... Mitsubishi 6D24-TE1  
**Type** ..... Water-cooled, direct fuel injection, with turbocharger

**No. of cylinder** ..... 6

**Bore and stroke** ..... 130 mm x 150 mm

**Displacement** ..... 11.945 liters

**Rated power** ..... 184 kW (250 PS) at 2,000 min<sup>-1</sup> (rpm)  
(JIS D0006-1994)

**Max. torque** ..... 1,030 N·m (105 kg·m) at 1,400 min<sup>-1</sup> (rpm)  
(JIS D0006-1994)

**Cooling system** ..... Liquid, recirculating bypass

**Starter** ..... 24 V, 5.5 kW

**Alternator** ..... 24 V, 80 A

**Cycles** ..... 4

**Radiator** ..... Corrugated type core, thermostatically controlled

**Air cleaner** ..... Dry type with replaceable paper element

**Throttle** ..... Electric throttle control, twist grip type

**Fuel tank capacity** ..... 400 liters

**Fuel filter** ..... Heavy duty with replaceable paper element

**Batteries** ..... Two 12V, 150 A-hr capacity batteries, series connected



### Hydraulic System

**Pumps:** Two variable displacement plunger pumps and fixed displacement plunger pump are driven by heavy-duty pump drive. One of variable displacement pump is used in the left propel circuit, boom hoist circuit and hook hoist circuit. Another is used in the right propel circuit and hook hoist circuit, and can accommodate an optional third circuit. Fixed displacement plunger pump is used in the swing circuit. In addition, two gear pumps are used in the control system and auxiliary equipment. One of these serves the clutch and brakes.

**Control:** Full-flow hydraulic control system for infinitely variable pressure to front and rear drums, boom hoist brakes and clutches. Controls respond instantly to the touch, delivering smooth function operation.

**Max. relief valve pressure:**

**Load hoist, boom hoist and propel system** ..... 30.9 MPa (315 kgf/cm<sup>2</sup>)

**Swing system** ..... 27.4 MPa (280 kgf/cm<sup>2</sup>)

**Control system** ..... 6.4 MPa (65 kgf/cm<sup>2</sup>)

**Reservoir capacity:** 325 liters

**Cooling:** Oil-to-air heat exchanger (plate-fin type)

**Filtration:** Full-flow and bypass type with replaceable paper element

**Electrical system:** All wiring coded for easy servicing, individual fused branch circuits.



### Boom Hoisting System

Powered by a hydraulic motor through a planetary reducer.

**Brake:** A spring-set, hydraulically released multiple-disc brake is mounted on the boom hoist motor and operated through a counter-balance valve.

**Drum lock:** External ratchet for locking drum.

**Drum:** Single drum, grooved for 20 mm dia. wire rope.

**Line speed:** Single line on first drum layer

**Hoisting** ..... 56/2 m/min

**Lowering** ..... 56/2 m/min



### Load Hoist System

Front and rear drums for load hoist powered by a hydraulic variable plunger motors, driven through planetary reducers.

**Clutches:** Internal expanding band type. 950 mm dia x 127 mm wide.

**Brakes:** External contracting band type. 1,150 mm dia x 150 mm wide with additional spring set hydraulically released brake, and external ratchet for locking drum.

Both positive and negative brake systems are available in lever neutral position.

**Drums:** (front and rear): 588 mm P.C.D. x 617 mm wide drums, each grooved for 26 mm wire rope.

Rope capacity of 185 m working length and 348 m storage length.

**Line speed:** Single line on the first drum layer

(Front drum)

**Hoisting** ..... 100/60/50/30 m/min

**Lowering** ..... 100/60/50/30 m/min

(Rear drum)

**Hoisting** ..... 100/60/50/30 m/min

**Lowering** ..... 100/60/50/30 m/min



### Swing System

**Swing unit:** Powered by hydraulic motor driving spur gears through planetary reducers, the swing system provides 360° rotation.

**Swing speed** ..... 3.5 min<sup>-1</sup> (rpm)

**Swing brakes:** A spring-set, hydraulically released multiple-disc brake is mounted on swing motor.

**Swing circle:** Single-row ball bearing with an integral internally cut swing gear.

**Swing lock:** Manually, four position lock for transportation

## Lower Machinery



**Carbody:** Steel-welded carbody with axles.

**Crawler:** Crawler assemblies can be hydraulically extended for wide track operation or retracted for transportation. Crawler belt tension is maintained by hydraulic jack force on the track-adjusting bearing block.

**Crawler drive:** Independent hydraulic propel drive is built into each side frame, each with a hydraulic motor propelling a driving tumbler through a planetary gear box. Propel motor and gear box are inside of crawler width.

**Crawler brakes:** Spring-set, hydraulically released multiple-disc parking brakes are built into each propel drive.

**Steering mechanism:** A hydraulic propel system provides both skid steering (driving one track only) and counter-rotating steering (driving tracks in opposite directions).

**Track rollers:** 9 lower rollers and 2 upper rollers are fitted to each side frame, sealed and maintenance-free.

**Shoes (flat):**

**Number** ..... 59 each side

**Standard flat shoe width** ..... 900 mm

**Max. travel speed:**

**High range** ..... 1.5 km/h

**Low range** ..... 1.0 km/h

**Max. gradeability:** 40%



### Weight

**Operating weight:** Approx. 84,800 kg (including 12.2 m (40 ft) boom and 90-ton hook block)

**Ground pressure:** Average 86 kPa (0.88 kgf/cm<sup>2</sup>) with 900 mm shoes

# Standard and Optional Equipment

## Standard Equipment

Upper structure/Lower structure
Counterweight (three pieces): 27.1 ton (total weight)
900mm-shoe crawlers
150AH battery
Gantry raising/lowering cylinder
Electric hand throttle grip
Variable boom hoist speed controller
Variable main/aux. hoist speed controller
Swing neutral-free/brake select switch
Side deck (for cab)
Step (equipped on left-side guard)
Two front working lights
Cab & Control
Totally enclosed, full vision cab with safety glass
Removable upper front window
Fully adjustable, high backed seat with a head-rest and armrests
Intermittent wiper and window washer (roof, front and lower front window)
Foot pedals for front and rear drum
Four short hand levers for front and rear drum, swing and boom drum controls
Safety Device
Boom back stop
Check & Safety Monitor (shows gauges and warning signs)
Over-hoist prevention device (w/ boom lowering slow stop function)
Release prevention key for hook over-hoist prevention device
Boom over-hoist auto-stop device
Hook over-hoist auto-stop device
Boom angle limit switch
Safety lever lock
Function lever lock switch (main, aux. and boom hoist)
Propel lever lock
Drum safety pawl (main, aux. and boom hoist)
Auto drum lock (boom hoist)
Negative brake in lever neutral-position (main, aux., boom hoist and propel)
Brake fail-safe function (main, aux., boom hoist and propel)
Lamp for neutral-free/brake select switch (main, aux. and swing)
Neutral-free/brake select switch with lock function (main, aux. and swing)
Neutral brake release prevention key (main and aux. hoist)
Automatic brake system in engine-stop
Hydraulically safety valve (main, aux., boom hoist and propel)
Signal horn
Swing lock pin (two position pin-hole lock)
Swing flashers
Swing warning buzzer

## Optional Equipment

Upper structure/Lower structure
Trans-Lifter
Hydraulic tagline
Reeving winch
170 AH battery for cold district areas
Drum cooling blower
Foot acceleration function (right pedal only or both pedals)
Drum rotating indicator
Load moment limiter
Vandalism guard for cab roof
Cat walks for each sides of upper machine
Hand rail equipped on top of upper machine
Ladder for right guard
Yellow rotating light
Obstacle light
Boom hoisting pedal (right pedal)
Level indicator
Anemometer
Electric fuel pump
One way call
Fire extinguisher
Electric fan

## Other amenities

Upper structure/Lower structure
Anti-slip sheet (mounted on the guard), Tools (for routine maintenance), Two back mirrors, Mirror for monitoring drums
Cab
Air conditioner, Convenient compartment (for tools), Cup holder, AM Radio, Ashtray, Cigarette lighter, Sun visor, Roof blind, Floor mat, Rubber cover for brake pedal, Shoe tray

# Transportation Data

# 7080.2

## Base Machine and Carbody

31,500 kg  
7,550 mm x 3,400 mm x 2,995 mm

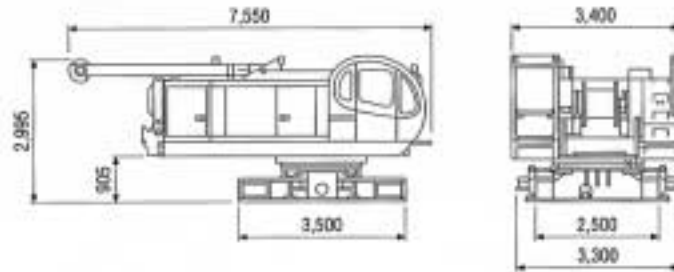

## Crawlers

10,200 kg x 2  
6,315 mm x 900 mm x 1,140 mm

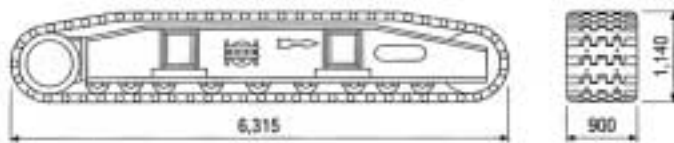

## Counterweight

Total: 27,700 kg (9,300 kg + 9,300 kg + 9,100 kg)  
A: 4,370 mm x 1,100 mm x 895 mm (9,300 kg)  
B: 4,370 mm x 1,100 mm x 805 mm (9,300 kg)  
C: 4,370 mm x 1,100 mm x 930 mm (9,100 kg)

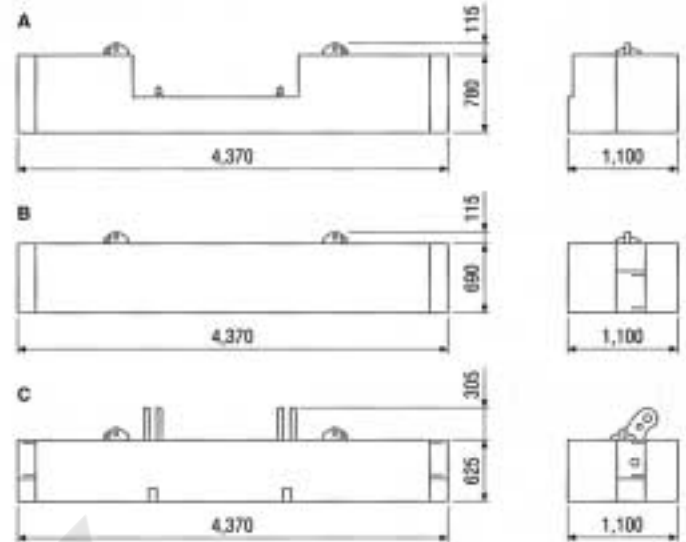

## Upper Boom

1,545 kg  
6,725 mm x 1,680 mm x 1,690 mm

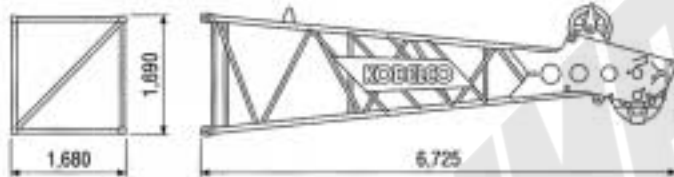

## Lower Boom

1,350 kg  
6,270 mm x 1,670 mm x 1,690 mm

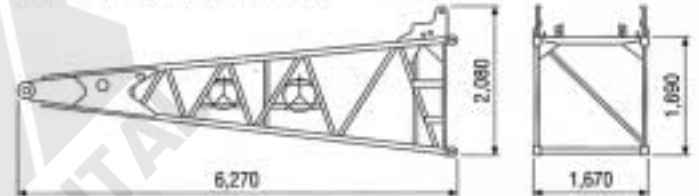

## Other Attachments

Attachment	Weight	Dimensions (L x W x H)
3.0 m (10 ft) Insert Boom	382 kg	3,165 mm x 1,670 mm x 1,690 mm
6.1 m (20 ft) Insert Boom	653 kg	6,240 mm x 1,670 mm x 1,690 mm
9.1 m (30 ft) Insert Boom	923 kg	9,260 mm x 1,670 mm x 1,690 mm
9.1 m (30 ft) Insert Boom with lug	948 kg	9,260 mm x 1,670 mm x 1,820 mm
9.1 m (30 ft) Insert Boom with spreader support	1,120 kg	9,260 mm x 1,670 mm x 2,190 mm
Upper Jib	280 kg	4,960 mm x 800 mm x 800 mm
Lower Jib	200 kg	4,810 mm x 800 mm x 800 mm
6.1 m (20 ft) Insert Jib	180 kg	6,160 mm x 800 mm x 800 mm
Jib Strut	250 kg	3,620 mm x 835 mm x 615 mm
Upper Spreader for Crane	337 kg	1,650 mm x 360 mm x 685 mm
Lower Spreader for Crane	192 kg	905 mm x 210 mm x 710 mm
Gantry	2,470 kg	4,210 mm x 1,760 mm x 490 mm
Tower Cap	1,160 kg	3,980 mm x 1,708 mm x 2,155 mm
Upper Jib for Tower	535 kg	6,445 mm x 1,145 mm x 1,145 mm
Lower Jib for Tower	935 kg	7,750 mm x 1,685 mm x 1,145 mm
3.0 m (10 ft) Insert Jib for Tower	166 kg	3,125 mm x 1,140 mm x 1,145 mm
6.1 m (20 ft) Insert Jib for Tower	295 kg	6,130 mm x 1,140 mm x 1,145 mm
6.1 m (10 ft) Tapered Insert Jib for Tower	310 kg	6,170 mm x 1,140 mm x 1,145 mm
Jib Strut for Tower	980 kg	5,255 mm x 1,790 mm x 795 mm
Upper Jib Spreader for Tower	278 kg	655 mm x 775 mm x 1,170 mm
Lower Jib Spreader for Tower	324 kg	1,665 mm x 390 mm x 845 mm
60-ton Hook Block	1,150 kg	1,970 mm x 700 mm x 470 mm
50-ton Hook Block	850 kg	1,860 mm x 700 mm x 410 mm
30-ton Hook Block	700 kg	1,580 mm x 700 mm x 340 mm
11-ton Ball-Hook Block	300 kg	1,050 mm x 357 mm dia.
11-ton Light-Weight Ball-Hook Block	100 kg	970 mm x 160 mm dia.

# General Dimensions

Unit: mm

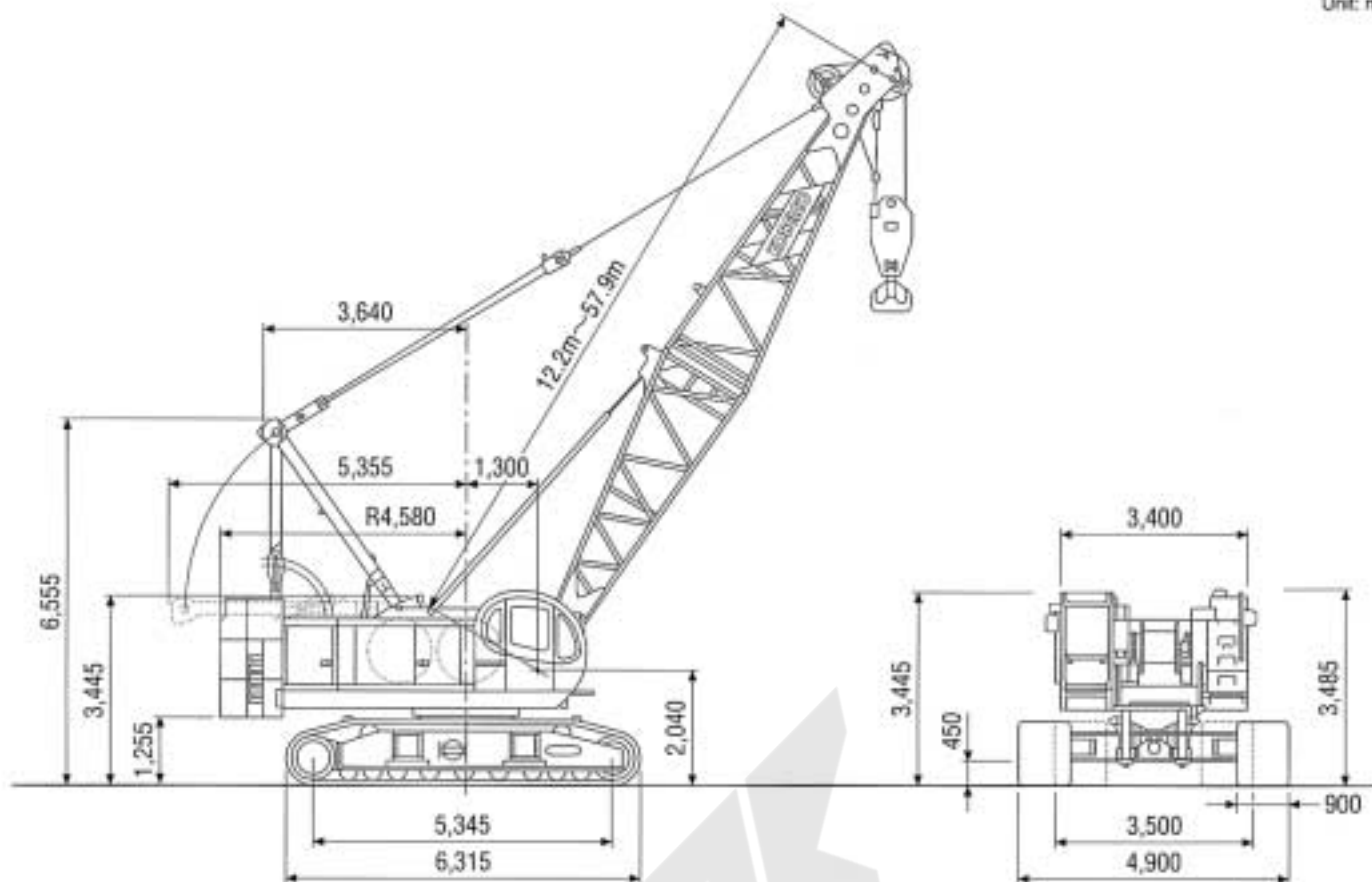

WMAK  
SALE & RENTAL





### Booms:

Welded lattice construction using tubular, high-tensile steel chords with pin connections between sections.

Max. lifting capacity	90,000 kg
Basic boom length	12.2 m (40')
Max. boom length	57.9 m (190')



### Jib (optional):

Welded lattice construction using tubular, high-tensile steel chords with pin connections between sections.

	Fixed jib
Max. lifting capacity	11,000 kg
Basic jib length	9.1 m (30')
Max. jib length	21.3 m (70')
Max. total length (Boom length + jib length)	51.8 m (170') + 21.3 (70')



### Hook blocks

A range of hook blocks can be specified, each with a safety latch.

Lifting capacity	90tons	50tons	30tons	11tons ball hook
No. of sheaves	4	3	1	0
Weight (kg)	1,150	850	700	300

### Diameter of wire ropes

#### Standard:

Hook hoist ..... 26 mm

Boom hoist (12-part line) ..... 20 mm

Boom guy line (2 lines) ..... 32 mm

#### Optional:

Jib hook hoist ..... 26 mm

Jib back stay guy line (2 lines) ..... 22 mm

**Boom hoist reeving:** 12 parts of 20 mm dia. wire rope

**Boom backstops:** required for all boom lengths

#### Line pull

(for crane, diaphragm wall bucket, etc.)

	Max. available	Max. permissible
Front	108 kN (11,000 kg)	206 kN (21,000 kg)
Rear	108 kN (11,000 kg)	206 kN (21,000 kg)

**Note:** Figures given for max. available line pull are theoretical values provided for reference purposes. Actual values will vary according to lifting conditions.

## Boom and Jib Arrangement

### Boom Arrangement Chart

Boom length m (ft)	Boom arrangement
12.2 (40)	Base-Tip
15.2 (50)	Base-A-Tip
18.3 (60)	Base-A-A-Tip, Base-B-Tip
21.3 (70)	Base-A-B-Tip, Base-C-Tip
24.4 (80)	Base-A-A-B-Tip, Base-A-C-Tip, Base-B-B-Tip
27.4 (90)	Base-A-B-B-Tip, Base-B-C-Tip, Base-A-A-C-Tip
30.5 (100)	Base-A-B-C-Tip, Base-C-C-Tip
33.5 (110)	Base-A-A-B-C-Tip, Base-B-B-C-Tip, Base-A-C-C-Tip
36.6 (120)	Base-A-B-B-C-Tip, Base-B-C-C-Tip
39.6 (130)	Base-A-B-C-C-Tip, Base-D-A-B-C-Tip, Base-C-C-C-Tip, Base-D-C-C-Tip
42.7 (140)	Base-A-A-B-C-C-Tip, Base-D-A-A-B-C-Tip, Base-B-B-C-C-Tip, Base-D-B-B-C-Tip, Base-A-C-C-C-Tip, Base-D-A-C-C-Tip
45.7 (150)	Base-A-B-B-C-C-Tip, Base-D-A-B-B-C-Tip, Base-B-C-C-C-Tip, Base-D-B-C-C-Tip
48.8 (160)	Base-A-B-C-C-C-Tip, Base-D-A-B-C-C-Tip
51.8 (170)	Base-A-A-B-C-C-C-Tip, Base-D-A-A-B-C-C-Tip, Base-B-B-C-C-C-Tip, Base-D-B-B-C-C-Tip
54.9 (180)	Base-A-B-B-C-C-C-Tip, Base-D-A-B-B-C-C-Tip
57.9 (190)	Base-A-A-B-B-C-C-C-Tip, Base-D-A-A-B-B-C-C-Tip

Base = 6.1 m (20'), Tip = 6.1 m (20')

Insert Boom: A = 3.0 m (10'), B = 6.1 m (20'), C = 9.1 m (30')

C' = 9.1 m (30') with lug for jib,

D = 9.1 m (30') with spreader support for tower jib

### Jib Arrangement Chart

Jib length m (ft)	Boom arrangement
9.1 (30)	Base-Tip
15.2 (50)	Base-A-Tip
21.3 (70)	Base-A-A-Tip

Base = 4.55 m (15'), Tip = 4.55 m (15')

Insert Jib: A = 6.1 m (20')

#### Note:

- Jib can be fitted to main boom between 33.5 m (110') and 51.8 m (170') in length.
- Fitting a jib requires 9.1 m (30') insert boom with lug.

# Boom Lifting Capacities

## Notes:

- Operating radius is the horizontal distance from centerline of rotation to a vertical line through the center of gravity the load.
- Raring do not exceed 75% of tipping load. Deduct weight of hook block(s), slings and all other load handling accessories from main boom or jib rating shown.
- Ratings shown are based on freely suspended loads and make no allowance for such factors as wind effect on lifted load, ground conditions out-of-level. Operating speeds or any other condition that could be detrimental to the safe operation of this equipment, the operator, therefore, has the responsibility to judge the existing conditions and reduce lifted loads and operating speeds accordingly.
- At radii and boom length where no ratings are shown no chart, operation is not intended or approved.
- Ratings surrounded by thick lines in the "Rated Loads" tables are determined by the machine's structural strength, and others are determined by the machine's stability.
- Gantry must be in raised position for all conditions.
- Boom inserts must be arranged as shown in the "BOOM ARRANGEMENT".
- Main Boom Rating Loads**  
Deduct weight of main hook, slings and all other load handling accessories from main boom rating loads shown.
- Auxiliary Sheave Rating Loads**  
Deduct weight of auxiliary hook block, slings and all other load handling accessories from auxiliary sheave rating loads shown.

## 10. Main Boom Rating Loads with Auxiliary Sheave

Deduct weight of main hook block, slings and all other load handling accessories from main boom rating loads (with auxiliary sheave) shown. Boom length for auxiliary sheave mounting is 12.2 m to 54.9 m.

## 11. Jib Rating Loads

Deduct weight of auxiliary hook block, slings and all other load handling accessories from jib rating loads shown.

## 12. Main Boom Rating Loads with Jib

Deduct weight of main hook block, slings and all other load handling accessories from main boom rating (with jib) loads shown. Jib inserts must be arranged as shown in the "JIB ARRANGEMENT"

Boom length for jib mounting is 33.5 m to 51.8 m.

## 13. Hoist Drum Rated Loads in Metric Tons

### Main Boom

No. of parts of line	1	2	3	4
Max. load (metric ton)	11	22	33	45
No. of parts of line	5	6	7	8
Max. load (metric ton)	56	67	79	90

### Jib

No. of parts of line	1
Max. load (metric ton)	11

- In principle, the boom should be erected over the front of the crawlers.
- Both crawlers should be fully extended.
- Figures shown by (ft) in the boom configuration are for reference only.

# Working Ranges

## Boom Working Range

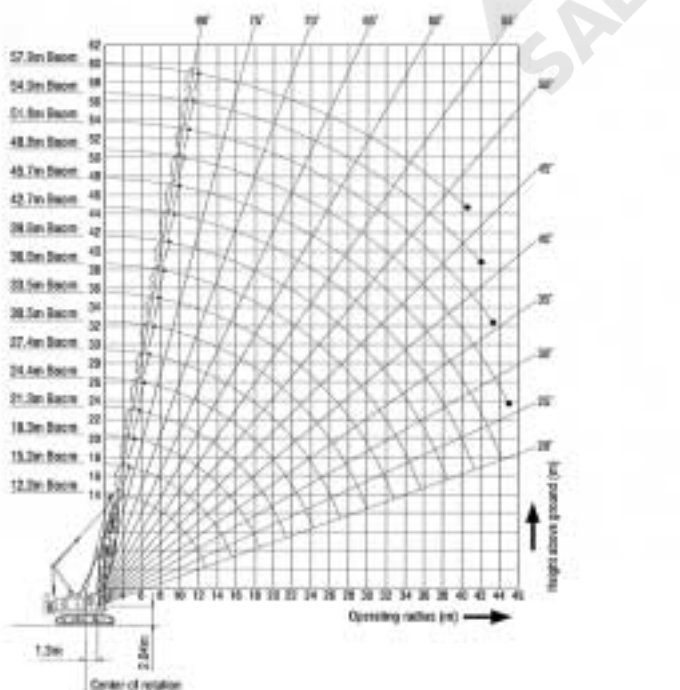

## Fixed Jib Working Range

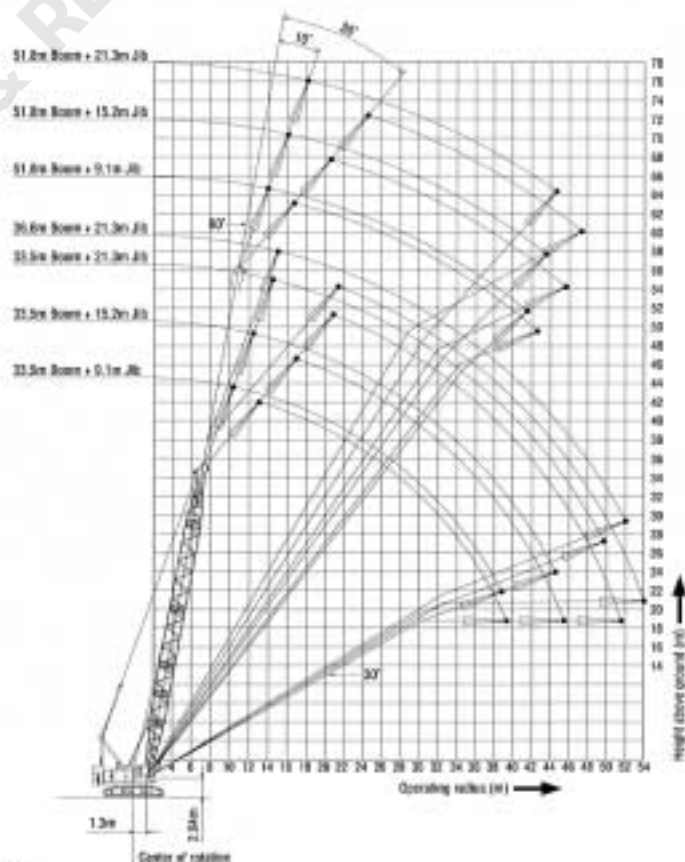

# Boom Lifting Capacities **7080.2**

Unit: metric ton

## Rated loads in metric tons for 360° working area (with 90-ton hook block)

Crawlers fully extended

Working radius m	Boom length m (ft)		Working radius m															
	12.2 (40)	15.2 (50)	18.3 (60)	21.3 (70)	24.4 (80)	27.4 (90)	30.5 (100)	33.5 (110)	36.6 (120)	39.6 (130)	42.7 (140)	45.7 (150)	48.8 (160)	51.8 (170)	54.9 (180)	57.9 (190)		
3.7	90.0																	
4.5	73.2	73.1/45	60.0/48															
5.0	63.3	63.3	60.0	59.4/54	50.0/59													
6.0	48.5	48.5	48.5	48.5	48.5	40.0/54	39.8/9											
7.0	39.1	38.9	38.8	38.7	38.6	38.6	38.6	35.5/7.5										
8.0	32.3	32.1	32.0	31.9	31.8	31.8	31.8	31.8	30.0/8.0	29.2/8.5								
9.0	27.5	27.3	27.2	27.1	27.0	26.9	26.9	26.9	26.9	26.9	26.0/1	25.1/9.6						
10.0	23.8	23.7	23.6	23.4	23.3	23.3	23.3	23.3	23.3	23.2	23.0	23.0	20.0/10.1	20.0/10.6	19.8/11.2	18.1/11.7		
12.0	18.3	18.3	18.3	18.3	18.2	18.1	18.1	18.1	18.1	18.0	17.8	17.8	17.8	17.8	17.8	17.7		
14.0	14.7/12.8	15.2	15.1	15.0	14.8	14.7	14.7	14.6	14.6	14.5	14.3	14.3	14.3	14.3	14.3	14.1		
16.0		11.9/15.7	12.7	12.6	12.4	12.3	12.3	12.2	12.2	12.1	11.9	11.9	11.9	11.8	11.7	11.5		
18.0			10.9	10.8	10.6	10.5	10.5	10.3	10.3	10.2	10.0	10.0	10.0	9.9	9.8	9.6		
20.0			9.8/18.5	9.4	9.2	9.1	9.0	8.9	8.9	8.8	8.6	8.6	8.6	8.4	8.3	8.1		
22.0				8.3/21.4	8.1	8.0	7.9	7.7	7.7	7.6	7.4	7.4	7.4	7.2	7.1	6.9		
24.0					7.2	7.1	7.0	6.8	6.8	6.7	6.5	6.5	6.4	6.3	6.1	5.9		
26.0					6.9/24.3	6.3	6.2	6.0	6.0	5.9	5.7	5.7	5.6	5.4	5.3	5.1		
28.0						5.8/27.1	5.8	5.4	5.4	5.2	5.0	5.0	5.0	4.8	4.6	4.4		
30.0							4.8/30.0	4.8	4.8	4.7	4.5	4.5	4.4	4.2	4.0	3.9		
32.0								4.4	4.3	4.2	4.0	4.0	3.9	3.7	3.5	3.3		
34.0								3.9/32.9	3.9	3.8	3.6	3.5	3.4	3.2	3.1	2.8		
36.0									3.3/35.7	3.4	3.2	3.2	3.0	2.8	2.6	2.3		
38.0										3.0	2.9	2.8	2.7	2.4	2.2	1.9		
40.0										2.7/38.6	2.6	2.5	2.3	2.0	1.8	1.6		
42.0											2.0/41.5	2.2	2.0	1.7	1.5/42.0	1.5/40.5		
44.0												1.6	1.6	1.5/43.3				
46.0												1.5/44.3	1.5/45.0					

# Auxiliary Sheave Lifting Capacities

Unit: metric ton

## Rated loads in metric tons for 360° working area (with 90-ton hook block)

Crawlers fully extended

Working radius m	Boom length m (ft)		Working radius m															
	12.2 (40)	15.2 (50)	18.3 (60)	21.3 (70)	24.4 (80)	27.4 (90)	30.5 (100)	33.5 (110)	36.6 (120)	39.6 (130)	42.7 (140)	45.7 (150)	48.8 (160)	51.8 (170)	54.9 (180)	57.9 (190)		
4.7	11.0/4.7																4.7	
5.0	11.0	11.0/5.3	11.0/5.8														5.0	
6.0	11.0	11.0	11.0	11.0/6.3	11.0/6.8												6.0	
7.0	11.0	11.0	11.0	11.0	11.0	11.0/7.3	11.0/7.9										7.0	
8.0	11.0	11.0	11.0	11.0	11.0	11.0	11.0	11.0/8.4	11.0/8.9								8.0	
9.0	11.0	11.0	11.0	11.0	11.0	11.0	11.0	11.0	11.0	11.0/9.5							9.0	
10.0	11.0	11.0	11.0	11.0	11.0	11.0	11.0	11.0	11.0	11.0	11.0/10.0	11.0/10.5	11.0/11.0	11.0/11.5			10.0	
12.0	11.0	11.0	11.0	11.0	11.0	11.0	11.0	11.0	11.0	11.0	11.0	11.0	11.0	11.0	11.0/12.1		12.0	
14.0	11.0	11.0	11.0	11.0	11.0	11.0	11.0	11.0	11.0	11.0	11.0	11.0	11.0	11.0	11.0		14.0	
16.0	11.0/14.2	11.0	11.0	11.0	11.0	10.9	10.9	10.8	10.8	10.7	10.5	10.5	10.4	10.3			16.0	
18.0		9.8/17.1	9.5	9.4	9.2	9.1	9.1	8.9	8.9	8.8	8.6	8.6	8.6	8.5	8.4		18.0	
20.0			8.1/20.0	8.0	7.8	7.7	7.6	7.5	7.5	7.4	7.2	7.2	7.2	7.0	6.9		20.0	
22.0				6.9	6.7	6.6	6.5	6.3	6.3	6.2	6.0	6.0	6.0	5.8	5.7		22.0	
24.0				6.1/22.8	5.8	5.7	5.6	5.4	5.4	5.3	5.1	5.1	5.0	4.9	4.7		24.0	
26.0					5.0/25.7	4.9	4.8	4.6	4.6	4.5	4.3	4.3	4.2	4.0	3.9		26.0	
28.0						4.3	4.2	4.0	4.0	3.8	3.6	3.6	3.4	3.2			28.0	
30.0						4.1/28.6	3.4	3.4	3.4	3.3	3.1	3.1	3.0	2.8	2.6		30.0	
32.0							3.1/31.4	3.0	2.9	2.8	2.6	2.6	2.5	2.3	2.1		32.0	
34.0								2.6	2.5	2.4	2.2	2.1	2.0	1.8	1.7		34.0	
36.0								2.5/34.3	2.1	2.0	1.8	1.8	1.6	1.5/35.6	1.5/34.8		36.0	
38.0									1.8/37.2	1.6	1.5/38.0	1.5/37.5	1.5/36.8				38.0	
40.0										1.5/38.2							40.0	

Note: rating inside shown in   are determined by the strength of the boom or other structural components.

# Auxiliary Sheave Lifting Capacities

Unit: metric ton

## Rated loads in metric tons for 360° working area (with 50-ton hook)

Crawlers fully extended

Working radius m	Boom length m (ft)	12.2	15.2	18.3	21.3	24.4	27.4	30.5	33.5	36.6	39.6	42.7	45.7	48.8	51.8	54.9	Boom length m (ft)	Working radius m
		(40)	(50)	(60)	(70)	(80)	(90)	(100)	(110)	(120)	(130)	(140)	(150)	(160)	(170)	(180)		
4.7	11.0/4.7																	4.7
5.0	11.0	11.05.3	11.05.8															5.0
6.0	11.0	11.0	11.0	11.06.3	11.06.8													6.0
7.0	11.0	11.0	11.0	11.0	11.0	11.07.3	11.07.9											7.0
8.0	11.0	11.0	11.0	11.0	11.0	11.0	11.0	11.08.4	11.08.9									8.0
9.0	11.0	11.0	11.0	11.0	11.0	11.0	11.0	11.0	11.0	11.09.5								9.0
10.0	11.0	11.0	11.0	11.0	11.0	11.0	11.0	11.0	11.0	11.0	11.09.0	11.09.5	11.09.10	11.09.15				10.0
12.0	11.0	11.0	11.0	11.0	11.0	11.0	11.0	11.0	11.0	11.0	11.0	11.0	11.0	11.0	11.0	11.0	11.0	12.0
14.0	11.0	11.0	11.0	11.0	11.0	11.0	11.0	11.0	11.0	11.0	11.0	11.0	11.0	11.0	11.0	11.0	11.0	14.0
16.0	11.0/4.2	11.0	11.0	11.0	11.0	11.0	11.0	11.0	11.0	11.0	11.0	11.0	11.0	11.0	11.0	11.0	10.8	16.0
18.0		10.1/17.1	9.8	9.7	9.5	9.4	9.4	9.2	9.2	9.1	8.9	8.9	8.9	8.9	8.8	8.7		18.0
20.0			8.4/20.0	8.3	8.1	8.0	7.9	7.8	7.8	7.7	7.5	7.5	7.5	7.3	7.2			20.0
22.0				7.2	7.0	6.9	6.8	6.8	6.6	6.5	6.3	6.3	6.3	6.1	6.0			22.0
24.0				6.4/22.8	6.1	6.0	5.9	5.7	5.7	5.6	5.4	5.4	5.3	5.2	5.0			24.0
26.0					5.3/25.7	5.2	5.1	4.9	4.9	4.8	4.6	4.6	4.5	4.3	4.2			26.0
28.0						4.6	4.5	4.3	4.3	4.1	3.9	3.9	3.9	3.7	3.5			28.0
30.0						4.4/28.6	3.7	3.7	3.7	3.6	3.4	3.4	3.3	3.1	2.9			30.0
32.0							3.4/31.4	3.3	3.2	3.1	2.9	2.9	2.8	2.6	2.4			32.0
34.0								2.9	2.8	2.7	2.5	2.4	2.3	2.1	1.9			34.0
36.0								2.8/34.3	2.4	2.3	2.1	2.1	1.9	1.7	1.5/36.0			36.0
38.0									2.1/37.2	1.9	1.8	1.7	1.6	1.5/37.0				38.0
40.0										1.8/40.0	1.5/40.0	1.5/39.2	1.5/38.6					40.0

Note: rating inside shown in  are determined by the strength of the boom or other structural components.

## Rated loads in metric tons for 360° working area (with 30-ton hook)

Crawlers fully extended

Working radius m	Boom length m (ft)	12.2	15.2	18.3	21.3	24.4	27.4	30.5	33.5	36.6	39.6	42.7	45.7	48.8	51.8	54.9	Boom length m (ft)	Working radius m
		(40)	(50)	(60)	(70)	(80)	(90)	(100)	(110)	(120)	(130)	(140)	(150)	(160)	(170)	(180)		
4.7	11.0/4.7																	4.7
5.0	11.0	11.05.3	11.05.8															5.0
6.0	11.0	11.0	11.0	11.06.3	11.06.8													6.0
7.0	11.0	11.0	11.0	11.0	11.0	11.07.3	11.07.9											7.0
8.0	11.0	11.0	11.0	11.0	11.0	11.0	11.0	11.08.4	11.08.9									8.0
9.0	11.0	11.0	11.0	11.0	11.0	11.0	11.0	11.0	11.0	11.09.5								9.0
10.0	11.0	11.0	11.0	11.0	11.0	11.0	11.0	11.0	11.0	11.0	11.09.0	11.09.5	11.09.10	11.09.15				10.0
12.0	11.0	11.0	11.0	11.0	11.0	11.0	11.0	11.0	11.0	11.0	11.0	11.0	11.0	11.0	11.0	11.0	11.0	12.0
14.0	11.0	11.0	11.0	11.0	11.0	11.0	11.0	11.0	11.0	11.0	11.0	11.0	11.0	11.0	11.0	11.0	11.0	14.0
16.0	11.0/4.2	11.0	11.0	11.0	11.0	11.0	11.0	11.0	11.0	11.0	11.0	11.0	11.0	11.0	11.0	11.0	11.0	16.0
18.0		10.3/17.1	10.0	9.9	9.7	9.6	9.6	9.4	9.4	9.3	9.1	9.1	9.1	9.0	8.9			18.0
20.0			8.8/20.0	8.5	8.3	8.2	8.1	8.0	8.0	7.9	7.7	7.7	7.7	7.5	7.4			20.0
22.0				7.4	7.2	7.1	7.0	6.8	6.8	6.7	6.5	6.5	6.5	6.3	6.2			22.0
24.0				6.9/22.8	6.3	6.2	6.1	5.9	5.9	5.8	5.6	5.6	5.5	5.4	5.2			24.0
26.0					5.5/25.7	5.4	5.3	5.1	5.1	5.0	4.8	4.8	4.7	4.5	4.4			26.0
28.0						4.8	4.7	4.5	4.5	4.3	4.1	4.1	4.1	3.9	3.7			28.0
30.0						4.6/28.6	3.9	3.9	3.9	3.8	3.6	3.6	3.5	3.3	3.1			30.0
32.0							3.8/31.4	3.5	3.4	3.3	3.1	3.1	3.0	2.8	2.6			32.0
34.0								3.1	3.0	2.9	2.7	2.6	2.5	2.3	2.2			34.0
36.0								3.0/34.3	2.6	2.5	2.3	2.3	2.1	1.9	1.7			36.0
38.0									2.3/37.2	2.1	2.0	1.9	1.8	1.5/38.0	1.5/37.0			38.0
40.0										1.8/40.0	1.7	1.6	1.5/39.6					40.0
42.0											1.5/40.5	1.5/40.6						42.0

Note: rating inside shown in  are determined by the strength of the boom or other structural components.

## Rated loads in metric tons for 360° working area (without main hook)

Crawlers fully extended

Working radius m	Boom length m (ft)																Working radius m
	12.2 (40)	15.2 (50)	18.3 (60)	21.3 (70)	24.4 (80)	27.4 (90)	30.5 (100)	33.5 (110)	36.6 (120)	39.8 (130)	42.7 (140)	45.7 (150)	48.8 (160)	51.8 (170)	54.9 (180)		
4.7	11,0/4.7																4.7
5.0	11.0	11,0/5.3	11,0/5.8														5.0
6.0	11.0	11.0	11.0	11,0/6.3	11,0/6.8												6.0
7.0	11.0	11.0	11.0	11.0	11.0	11,0/7.3	11,0/7.8										7.0
8.0	11.0	11.0	11.0	11.0	11.0	11.0	11.0	11,0/8.4	11,0/8.9								8.0
9.0	11.0	11.0	11.0	11.0	11.0	11.0	11.0	11.0	11.0	11,0/9.5							9.0
10.0	11.0	11.0	11.0	11.0	11.0	11.0	11.0	11.0	11.0	11.0	11,0/10.0	11,0/10.5	11,0/11.0	11,0/11.6			10.0
12.0	11.0	11.0	11.0	11.0	11.0	11.0	11.0	11.0	11.0	11.0	11.0	11.0	11.0	11.0	11,0/12.1		12.0
14.0	11.0	11.0	11.0	11.0	11.0	11.0	11.0	11.0	11.0	11.0	11.0	11.0	11.0	11.0	11.0	11.0	14.0
16.0	11,0/14.2	11.0	11.0	11.0	11.0	11.0	11.0	11.0	11.0	11.0	11.0	11.0	11.0	11.0	11.0	11.0	16.0
18.0		11,0/17.1	10.7	10.6	10.4	10.3	10.3	10.1	10.1	10.0	9.8	9.8	9.8	9.7	9.6		18.0
20.0			9,3/20.0	9.2	9.0	8.9	8.8	8.7	8.7	8.6	8.4	8.4	8.4	8.2	8.1		20.0
22.0				8.1	7.9	7.8	7.7	7.5	7.5	7.4	7.2	7.2	7.2	7.0	6.9		22.0
24.0				7,3/22.8	7.0	6.9	6.8	6.6	6.6	6.5	6.3	6.3	6.2	6.1	5.9		24.0
26.0					6,2/25.7	6.1	6.0	5.8	5.8	5.7	5.5	5.5	5.4	5.2	5.1		26.0
28.0						5.5	5.4	5.2	5.2	5.0	4.8	4.8	4.8	4.6	4.4		28.0
30.0						5,3/28.6	4.6	4.6	4.6	4.5	4.3	4.3	4.2	4.0	3.8		30.0
32.0							4,3/31.4	4.2	4.1	4.0	3.8	3.8	3.7	3.5	3.3		32.0
34.0								3.8	3.7	3.6	3.4	3.3	3.2	3.0	2.9		34.0
36.0								3,7/34.3	3.3	3.2	3.0	3.0	2.8	2.6	2.4		36.0
38.0									3,0/37.2	2.8	2.7	2.6	2.5	2.2	2.0		38.0
40.0										2,5/40.0	2.4	2.3	2.1	1.8	1.6		40.0
42.0											2.1	2.0	1.8	1,5/42.0	1,5/40.8		42.0
44.0											1,6/42.9	1,5/43.6	1,5/43.6				44.0

 Note: rating inside shown in  are determined by the strength of the boom or other structural components.

# Fixed Jib Lifting Capacities

Unit: metric ton

## Jib Rated loads in metric tons for 360° working area (Jib offset angle 10°/with 50-ton or 30-ton hook)

Crawlers fully extended

Boom Length m (ft)		33.5 (110)			36.6 (120)			39.6 (130)			42.7 (140)			Boom Length m (ft)	
Working radius m	Jib length m (ft)	9.1 (30)	15.2 (50)	21.3 (70)	9.1 (30)	15.2 (50)	21.3 (70)	9.1 (30)	15.2 (50)	21.3 (70)	9.1 (30)	15.2 (50)	21.3 (70)	Jib length m (ft)	Working radius m
		10.0	11.0/10.0				11.0/10.6			11.0/11.1			11.0/11.6		
12.0	11.0	8.0/12.1	4.3/13.6		11.0	8.0/12.7		11.0	8.0/13.2		11.0	8.0/13.7		12.0	
14.0	11.0	8.0	4.3		11.0	8.0	4.3/14.1	11.0	8.0	4.3/14.7	11.0	8.0	4.3/15.2	14.0	
16.0	11.0	8.0	4.3		11.0	8.0	4.3	11.0	8.0	4.3	11.0	8.0	4.3	16.0	
18.0	10.0	8.0	4.3		9.9	8.0	4.3	9.8	8.0	4.3	9.7	8.0	4.3	18.0	
20.0	8.5	8.0	4.3		8.4	8.0	4.3	8.3	8.0	4.3	8.2	8.0	4.3	20.0	
22.0	7.3	7.7	4.3		7.3	7.6	4.3	7.1	7.5	4.3	7.0	7.3	4.3	22.0	
24.0	6.4	6.7	4.3		6.3	6.6	4.3	6.2	6.5	4.3	6.0	6.3	4.3	24.0	
26.0	5.6	5.9	4.3		5.5	5.8	4.3	5.4	5.7	4.3	5.2	5.5	4.3	26.0	
28.0	4.9	5.2	4.3		4.8	5.1	4.3	4.7	5.0	4.3	4.5	4.8	4.3	28.0	
30.0	4.3	4.6	4.3		4.2	4.5	4.3	4.1	4.4	4.3	3.9	4.2	4.3	30.0	
32.0	3.8	4.1	4.3		3.7	4.0	4.2	3.6	3.9	4.0	3.4	3.7	3.9	32.0	
34.0	3.3	3.6	3.8		3.3	3.5	3.7	3.1	3.4	3.6	3.0	3.2	3.4	34.0	
36.0	3.0	3.2	3.4		2.9	3.1	3.3	2.7	3.0	3.2	2.5	2.8	3.0	36.0	
38.0	2.6	2.9	3.1		2.5	2.8	2.9	2.3	2.7	2.8	2.1	2.5	2.7	38.0	
40.0	2.3/39.0	2.6	2.7		2.1	2.5	2.6	2.0	2.3	2.5	1.7	2.1	2.3	40.0	
42.0		2.3	2.4	1.8/41.7	2.1	2.3	2.3	1.6	2.0	2.2	1.5/41.6	1.7	1.9	42.0	
44.0		2.0	2.2		1.8	2.0	1.5/42.6	1.7	1.9		1.5/43.6	1.6		44.0	
46.0		1.8/44.8	1.9		1.5/46.0	1.8		1.5/45.6	1.6			1.5/44.6		46.0	
48.0			1.7/48.0			1.5/48.0			1.5/46.6					48.0	

Note: rating inside shown in  are determined by the strength of the boom or other structural components.

Boom Length m (ft)		45.7 (150)			48.8 (160)			51.8 (170)			Boom Length m (ft)		
Working radius m	Jib length m (ft)	9.1 (30)	15.2 (50)	21.3 (70)	9.1 (30)	15.2 (50)	21.3 (70)	9.1 (30)	15.2 (50)	21.3 (70)	Jib length m (ft)	Working radius m	
		10.0											
12.0	11.0/12.1				11.0/12.7			11.0/13.2					12.0
14.0	11.0	8.0/14.2	4.3/15.7		11.0	8.0/14.8		11.0	8.0/15.3				14.0
16.0	11.0	8.0	4.3		11.0	8.0	4.3/16.3	11.0	8.0	4.3/16.8			16.0
18.0	9.7	8.0	4.3		9.7	8.0	4.3	9.5	8.0	4.3			18.0
20.0	8.2	8.0	4.3		8.2	8.0	4.3	8.0	8.0	4.3			20.0
22.0	7.0	7.3	4.3		6.9	7.3	4.3	6.7	7.1	4.3			22.0
24.0	6.0	6.3	4.3		5.9	6.3	4.3	5.7	6.1	4.3			24.0
26.0	5.2	5.5	4.3		5.1	5.4	4.3	4.9	5.2	4.3			26.0
28.0	4.5	4.8	4.3		4.4	4.7	4.3	4.2	4.5	4.3			28.0
30.0	3.8	4.2	4.3		3.8	4.1	4.2	3.6	3.9	4.1			30.0
32.0	3.3	3.6	3.8		3.2	3.5	3.7	2.9	3.3	3.5			32.0
34.0	2.8	3.2	3.3		2.6	3.0	3.2	2.4	2.8	3.0			34.0
36.0	2.3	2.7	2.9		2.1	2.5	2.8	1.9	2.3	2.5			36.0
38.0	1.8	2.2	2.5	1.7/38.0	2.1	2.3	1.5/38.0	1.8	2.1				38.0
40.0	1.5/40.0	1.8	2.1		1.7	1.9		1.5/39.5	1.7				40.0
42.0		1.5/42.0	1.7		1.5/41.0	1.6			1.5/41.0				42.0
44.0			1.5/43.6			1.5/42.5							44.0
46.0													46.0
48.0													48.0

Note: rating inside shown in  are determined by the strength of the boom or other structural components.

## Jib Rated loads in metric tons for 360° working area (Jib offset angle 30°/with 50-ton or 30-ton hook)

Crawlers fully extended

Boom Length m (ft)		33.5 (110)			36.6 (120)			49.6 (130)			42.7 (140)			Boom Length m (ft)	
Working radius m	Jib length m (ft)	9.1 (30)	15.2 (50)	21.3 (70)	9.1 (30)	15.2 (50)	21.3 (70)	9.1 (30)	15.2 (50)	21.3 (70)	9.1 (30)	15.2 (50)	21.3 (70)	Jib length m (ft)	Working radius m
	10.0														
12.0	9.3/12.8				9.3/12.8									12.0	
14.0	9.3				9.3			9.3/14.0			9.3/14.3			14.0	
16.0	9.3	5.0/16.7			9.3	5.0/17.2		9.3	5.0/17.7		9.3			16.0	
18.0	9.3	5.0			9.3	5.0		9.3	5.0		9.3	5.0/18.2		18.0	
20.0	8.9	5.0	3.1/20.2		8.9	5.0	3.1/20.6	8.8	5.0	3.1/21.2	8.6	5.0	3.1/21.7	20.0	
22.0	7.7	5.0	3.1		7.6	5.0	3.1	7.5	5.0	3.1	7.4	5.0	3.1	22.0	
24.0	6.7	5.0	3.1		6.6	5.0	3.1	6.5	5.0	3.1	6.4	5.0	3.1	24.0	
26.0	5.8	5.0	3.1		5.8	5.0	3.1	5.7	5.0	3.1	5.5	5.0	3.1	26.0	
28.0	5.1	5.0	3.1		5.0	5.0	3.1	4.9	5.0	3.1	4.8	5.0	3.1	28.0	
30.0	4.5	4.9	3.1		4.4	4.9	3.1	4.3	4.8	3.1	4.2	4.6	3.1	30.0	
32.0	3.9	4.4	3.1		3.9	4.3	3.1	3.8	4.2	3.1	3.6	4.1	3.1	32.0	
34.0	3.5	3.9	3.1		3.4	3.8	3.1	3.3	3.7	3.1	3.2	3.6	3.1	34.0	
36.0	3.1	3.5	3.1		3.0	3.4	3.1	2.9	3.3	3.1	2.7	3.2	3.1	36.0	
38.0	2.7	3.1	3.0		2.6	3.0	3.0	2.5	2.9	3.0	2.3	2.8	3.0	38.0	
40.0	2.3/39.8	2.7	2.9		2.2	2.7	2.9	2.1	2.6	2.8	1.9	2.4	2.7	40.0	
42.0		2.4	2.7		1.9	2.3	2.6	1.7	2.2	2.5	1.5/42.0	2.0	2.4	42.0	
44.0		2.1	2.4	1.7/42.3		2.0	2.3	1.5/43.3	1.9	2.2		1.7	2.1	44.0	
46.0		1.7/45.8	2.1			1.7	2.1		1.6	1.9		1.5/45.0	1.7	46.0	
48.0			1.9			1.5/47.3	1.8		1.5/48.6	1.6			1.5/47.3	48.0	
50.0			1.6				1.5/50.0				1.5/48.6			50.0	
52.0			1.5/50.6											52.0	

 Note: rating inside shown in  are determined by the strength of the boom or other structural components.

Boom Length m (ft)		45.7 (150)			48.8 (160)			51.8 (170)			Boom Length m (ft)	
Working radius m	Jib length m (ft)	9.1 (30)	15.2 (50)	21.3 (70)	9.1 (30)	15.2 (50)	21.3 (70)	9.1 (30)	15.2 (50)	21.3 (70)	Jib length m (ft)	Working radius m
	12.0											
14.0	9.3/14.9				9.3/15.4							14.0
16.0	9.3				9.3			9.3/15.0				16.0
18.0	9.3	5.0/18.8			9.3	5.0/19.3		9.2				18.0
20.0	8.6	5.0			8.6	5.0		8.5	5.0/20.0			20.0
22.0	7.4	5.0	3.1/22.2		7.4	5.0	3.1/22.7	7.2	5.0			22.0
24.0	6.4	5.0	3.1		6.3	5.0	3.1	6.2	5.0	3.1/24.0		24.0
26.0	5.5	5.0	3.1		5.5	5.0	3.1	5.3	5.0	3.1		26.0
28.0	4.8	5.0	3.1		4.7	5.0	3.1	4.5	5.0	3.1		28.0
30.0	4.1	4.6	3.1		4.1	4.6	3.1	3.9	4.4	3.1		30.0
32.0	3.6	4.1	3.1		3.5	4.0	3.1	3.3	3.8	3.1		32.0
34.0	3.1	3.5	3.1		3.0	3.5	3.1	2.7	3.3	3.1		34.0
36.0	2.5	3.1	3.1		2.4	3.0	3.1	2.2	2.8	3.1		36.0
38.0	2.1	2.6	3.0		2.0	2.5	2.9	1.7/38.0	2.3	2.8		38.0
40.0	1.7	2.2	2.6	1.8/40.0		2.1	2.5		1.9	2.3		40.0
42.0	1.5/41.0	1.8	2.2			1.7	2.1		1.5/42.0	1.9		42.0
44.0		1.5/44.0	1.9			1.5/43.0	1.8			1.6		44.0
46.0			1.5/46.0				1.5/45.5				1.5/44.5	46.0
48.0												48.0
50.0												50.0
52.0												52.0

 Note: rating inside shown in  are determined by the strength of the boom or other structural components.

# Fixed Jib Lifting Capacities

Unit: metric ton

## Jib Rated loads in metric tons for 360° working area (Jib offset angle 10°/without main hook)

Crawlers fully extended

Boom Length m (ft)		33.5 (110)			36.6 (120)			39.6 (130)			42.7 (140)			Boom Length m (ft)	
Working radius m	Jib length m (ft)	9.1 (30)	15.2 (50)	21.3 (70)	9.1 (30)	15.2 (50)	21.3 (70)	9.1 (30)	15.2 (50)	21.3 (70)	9.1 (30)	15.2 (50)	21.3 (70)	Jib length m (ft)	Working radius m
	10.0	11.0/10.0				11.0/10.6			11.0/11.1			11.0/11.6			
12.0	11.0	8.0/12.1	4.3/13.6	11.0	8.0/12.7		11.0	8.0/13.2		11.0	8.0/13.7		12.0		
14.0	11.0	8.0	4.3	11.0	8.0	4.3/14.1	11.0	8.0	4.3/14.7	11.0	8.0	4.3	14.0		
16.0	11.0	8.0	4.3	11.0	8.0	4.3	11.0	8.0	4.3	11.0	8.0	4.3	16.0		
18.0	10.4	8.0	4.3	10.4	8.0	4.3	10.3	8.0	4.3	10.1	8.0	4.3	18.0		
20.0	9.0	8.0	4.3	8.7	8.0	4.3	8.8	8.0	4.3	8.6	8.0	4.3	20.0		
22.0	7.8	8.0	4.3	7.7	8.0	4.3	7.6	7.9	4.3	7.4	7.7	4.3	22.0		
24.0	6.8	7.1	4.3	6.7	7.0	4.3	6.6	6.9	4.3	6.5	6.7	4.3	24.0		
26.0	6.0	6.3	4.3	5.9	6.2	4.3	5.8	6.1	4.3	5.7	5.9	4.3	26.0		
28.0	5.3	5.6	4.3	5.2	5.5	4.3	5.1	5.4	4.3	5.0	5.2	4.3	28.0		
30.0	4.8	5.0	4.3	4.7	4.9	4.3	4.6	4.8	4.3	4.4	4.6	4.3	30.0		
32.0	4.2	4.5	4.3	4.2	4.4	4.3	4.1	4.3	4.3	3.9	4.1	4.2	32.0		
34.0	3.8	4.0	4.1	3.7	3.9	4.0	3.6	3.8	3.9	3.4	3.7	3.8	34.0		
36.0	3.4	3.6	3.7	3.3	3.5	3.6	3.2	3.4	3.5	3.0	3.3	3.4	36.0		
38.0	3.1	3.3	3.4	3.0	3.2	3.3	2.9	3.1	3.2	2.7	2.9	3.0	38.0		
40.0	3.0/39.0	3.0	3.1	2.7	2.9	3.0	2.6	2.8	2.9	2.4	2.6	2.7	40.0		
42.0		2.7	2.8	2.4	2.6	2.7	2.3	2.5	2.6	2.0	2.3	2.4	42.0		
44.0		2.4	2.5	1.8	2.3	2.4	2.0	2.2	2.3	1.7	2.0	2.2	44.0		
46.0		2.3/44.8	2.3	1.5/44.9	2.1	2.2	1.9/44.4	2.0	2.1	1.5/46.0	1.7	1.9	46.0		
48.0			2.1	1.9/47.5	2.0		1.7	1.8		1.5/48.0	1.6		48.0		
50.0			1.5/49.7			1.8		1.5/50.0	1.6			1.5/49.0	50.0		
52.0						1.5/52.0			1.5/51.0				52.0		

Note: rating inside shown in  are determined by the strength of the boom or other structural components.

Boom Length m (ft)		45.7 (150)			48.8 (160)			51.8 (170)			Boom Length m (ft)		
Working radius m	Jib length m (ft)	9.1 (30)	15.2 (50)	21.3 (70)	9.1 (30)	15.2 (50)	21.3 (70)	9.1 (30)	15.2 (50)	21.3 (70)	Jib length m (ft)	Working radius m	
	10.0												
12.0	11.0/12.1				11.0/12.7			11.0/13.2				12.0	
14.0	11.0	8.0/14.2	4.3/15.7	11.0	8.0/14.8		11.0	8.0/15.3		11.0	8.0/15.8	14.0	
16.0	11.0	8.0	4.3	11.0	8.0	4.3/16.3	11.0	8.0	4.3/16.8	11.0	8.0	4.3	16.0
18.0	10.1	8.0	4.3	10.1	8.0	4.3	10.0	8.0	4.3	9.8	8.0	4.3	18.0
20.0	8.6	8.0	4.3	8.6	8.0	4.3	8.5	8.0	4.3	8.3	8.0	4.3	20.0
22.0	7.4	7.7	4.3	7.4	7.7	4.3	7.2	7.5	4.3	7.0	7.3	4.3	22.0
24.0	6.5	6.7	4.3	6.4	6.7	4.3	6.2	6.5	4.3	6.0	6.3	4.3	24.0
26.0	5.6	5.9	4.3	5.6	5.8	4.3	5.4	5.7	4.3	5.2	5.5	4.3	26.0
28.0	4.9	5.2	4.3	4.9	5.1	4.3	4.7	4.9	4.3	4.5	4.7	4.3	28.0
30.0	4.3	4.6	4.3	4.3	4.5	4.3	4.1	4.3	4.3	3.9	4.1	4.3	30.0
32.0	3.8	4.1	4.2	3.7	4.0	4.1	3.6	3.8	3.9	3.4	3.6	3.9	32.0
34.0	3.4	3.6	3.7	3.3	3.5	3.6	3.1	3.3	3.5	2.9	3.1	3.5	34.0
36.0	3.0	3.2	3.3	2.8	3.1	3.2	2.6	2.9	3.0	2.4	2.7	3.0	36.0
38.0	2.5	2.8	2.9	2.4	2.7	2.8	2.1	2.5	2.6	2.0	2.4	2.6	38.0
40.0	2.1	2.4	2.6	2.0	2.3	2.5	1.8	2.1	2.2	1.6	1.9	2.2	40.0
42.0	1.8	2.1	2.2	1.7/42.0	2.0	2.1	1.5/41.5	1.7	1.9				42.0
44.0	1.5/44.0	1.8	1.9		1.6	1.8		1.5/43.5	1.6				44.0
46.0		1.5/46.0	1.6		1.5/44.7	1.5/46.0				1.5/44.6			46.0
48.0			1.5/47.0										48.0
50.0													50.0
52.0													52.0

Note: rating inside shown in  are determined by the strength of the boom or other structural components.



## Jib Rated loads in metric tons for 360° working area (Jib offset angle 30°/without main hook)

Crawlers fully extended

Boom Length m (ft)		33.5 (110)			36.6 (120)			39.6 (130)			42.7 (140)			Boom Length m (ft)	
Working radius m	Jib length m (ft)	9.1 (30)	15.2 (50)	21.3 (70)	9.1 (30)	15.2 (50)	21.3 (70)	9.1 (30)	15.2 (50)	21.3 (70)	9.1 (30)	15.2 (50)	21.3 (70)	Jib length m (ft)	Working radius m
	10.0														
12.0	9.3/12.6				9.3/13.3										12.0
14.0	9.3				9.3			9.3/14.0			9.3/14.3				14.0
16.0	9.3	5.0/15.7			9.3	5.0/17.2		9.3	5.0/17.7		9.3				16.0
18.0	9.3	5.0			9.3	5.0		9.3	5.0		9.3	5.0/18.2			18.0
20.0	9.3	5.0	3.1/20.2		9.2	5.0	3.1/20.6	9.2	5.0	3.1/21.2	9.0	5.0	3.1/21.7		20.0
22.0	8.1	5.0	3.1	8.0	5.0	3.1	7.9	5.0	3.1	7.8	5.0	3.1			22.0
24.0	7.1	5.0	3.1	7.0	5.0	3.1	6.9	5.0	3.1	6.8	5.0	3.1			24.0
26.0	6.2	5.0	3.1	6.2	5.0	3.1	6.1	5.0	3.1	5.9	5.0	3.1			26.0
28.0	5.5	5.0	3.1	5.4	5.0	3.1	5.4	5.0	3.1	5.2	5.0	3.1			28.0
30.0	4.9	5.0	3.1	4.8	5.0	3.1	4.7	5.0	3.1	4.6	5.0	3.1			30.0
32.0	4.4	4.7	3.1	4.3	4.6	3.1	4.2	4.6	3.1	4.1	4.4	3.1			32.0
34.0	3.9	4.2	3.1	3.8	4.2	3.1	3.8	4.1	3.1	3.6	3.9	3.1			34.0
36.0	3.5	3.8	3.1	3.4	3.7	3.1	3.3	3.7	3.1	3.2	3.5	3.1			36.0
38.0	3.1	3.4	3.0	3.1	3.4	3.0	3.0	3.3	3.0	2.8	3.1	3.0			38.0
40.0	2.8/39.7	3.1	2.9	2.7	3.0	2.9	2.6	2.9	2.9	2.5	2.8	2.9			40.0
42.0		2.8	2.8	2.4	2.7	2.8	2.4	2.6	2.7	2.2	2.5	2.7			42.0
44.0		2.5	2.7	2.3/42.3	2.4	2.6	2.1	2.4	2.5	1.8	2.2	2.4			44.0
46.0		2.3/45.8	2.5		2.2	2.4	1.9/45.0	2.1	2.3	1.5/46.0	1.9	2.2			46.0
48.0			2.2		1.9/48.0	2.2		1.8	2.0		1.6	1.9			48.0
50.0			2.0			1.9		1.5/50.0	1.8		1.5/49.0	1.6			50.0
52.0			1.8/51.9			1.7			1.6			1.5/51.0			52.0
54.0						1.5/54.0			1.5/52.6						54.0

 Note: rating inside shown in  are determined by the strength of the boom or other structural components.

Boom Length m (ft)		45.7 (150)			48.8 (160)			51.8 (170)			Boom Length m (ft)	
Working radius m	Jib length m (ft)	9.1 (30)	15.2 (50)	21.3 (70)	9.1 (30)	15.2 (50)	21.3 (70)	9.1 (30)	15.2 (50)	21.3 (70)	Jib length m (ft)	Working radius m
	12.0											
14.0	9.3/14.9				9.3/15.4							14.0
16.0	9.3				9.3			9.3/16.0				16.0
18.0	9.3	5.0/18.8			9.3	5.0/19.3		9.3				18.0
20.0	9.0	5.0			9.0	5.0		9.0	5.0/20.0			20.0
22.0	7.8	5.0	3.1/22.2		7.8	5.0	3.1/22.7	7.7	5.0			22.0
24.0	6.8	5.0	3.1	6.8	5.0	3.1	6.6	5.0	3.1/23.2			24.0
26.0	5.9	5.0	3.1	5.9	5.0	3.1	5.7	5.0	3.1			26.0
28.0	5.2	5.0	3.1	5.1	5.0	3.1	5.0	5.0	3.1			28.0
30.0	4.6	5.0	3.1	4.5	4.9	3.1	4.4	4.8	3.1			30.0
32.0	4.0	4.4	3.1	4.0	4.4	3.1	3.8	4.2	3.1			32.0
34.0	3.5	3.9	3.1	3.5	3.9	3.1	3.3	3.7	3.1			34.0
36.0	3.1	3.5	3.1	3.1	3.4	3.1	2.9	3.3	3.1			36.0
38.0	2.7	3.1	3.0	2.6	3.0	3.0	2.4	2.9	3.0			38.0
40.0	2.3	2.7	2.9	2.2	2.7	2.9	2.0	2.5	2.8			40.0
42.0	1.9	2.4	2.7	1.8	2.3	2.6	1.6	2.1	2.4			42.0
44.0	1.6	2.0	2.3	1.5/44.0	1.9	2.3	1.5/42.6	1.7	2.1			44.0
46.0	1.5/44.6	1.7	2.0		1.6	1.9		1.5/45.6	1.7			46.0
48.0		1.5/47.5	1.7/48.0		1.5/46.6	1.6/48.0			1.5/47.3			48.0
50.0												50.0
52.0												52.0
54.0												54.0

 Note: rating inside shown in  are determined by the strength of the boom or other structural components.

# Luffing Tower Attachment



## Tower (optional):

Welded lattice construction using tubular, high-tensile steel chords with pin connections between sections.

Max. lifting capacity	15,000 kg
Basic tower length	25.9 m (85')
Max. tower length	44.2 m (145')



## Jib (optional):

Welded lattice construction using tubular, high-tensile steel chords with pin connections between sections.

	Tower jib
Basic jib length	19.8 m (65')
Max. total length (Tower length + jib length)	44.2m (145') + 35.1 m (115')



## Hook blocks

A range of hook blocks can be specified, each with a safety latch.

Lifting capacity	30 tons	11 tons ball hook
No. of sheaves	1	0
Weight (kg)	700	300

## Diameter of wire ropes

### Standard:

Hook hoist .....	26 mm
Tower hoist (12-part line) .....	20 mm
Tower guy line (2 lines) .....	32 mm

### Optional:

Jib hook hoist .....	26 mm
Jib back stay guy line (2 lines) .....	30 mm

**Jib hoist reeving:** 8 parts of 26 mm dia. wire rope

**Tower backstops:** required for all tower lengths

# Lifting capacities

## Notes:

- Operating radius is the horizontal distance from centerline of rotation to a vertical line through the center of gravity the load.
- Raring do not exceed 75% of tipping load. Deduct weight of hook block(s), slings and all other load handling accessories from main boom or jib rating shown.
- Ratings shown are based on freely suspended loads and make no allowance for such factors as wind effect on lifted load, ground conditions out-of-level. Operating speeds or any other condition that could be detrimental to the safe operation of this equipment, the operator, therefore, has the responsibility to judge the existing conditions and reduce lifted loads and operating speeds accordingly.
- At radii and tower and tower jib length where no ratings are shown no chart, operation is not intended or approved.
- Ratings surrounded by thick lines in the "Rated Loads" tables are determined by the machine's structural strength, and others are determined by the machine's stability.
- Gantry must be in raised position for all conditions.

- Tower and tower jib inserts must be arranged as shown in the "Tower and Jib Arrangement".
- Luffing Tower Rating Loads**  
Deduct weight of hook block, slings and all other load handling accessories from luffing tower rating loads shown.
- Max. hoisting load by number of reeving

No. of parts of line	1	2
Max. load (metric ton)	11	15

- 11-ton ball hook cannot be fitted to jib of 19.8 m.
- When tower length is over 41.1 m, pillow plate in front of crawlers must be used for erection.
- Always have the gantry fully raised and use the backstop during operations.
- Tower hoist reeving must be twelve parts of line.
- Both crawlers should be fully extended.
- Figures shown by (ft) in the tower (and jib) configuration are for reference only.

# Luffing Tower Working Ranges

**Tower Length: 35.1 m**

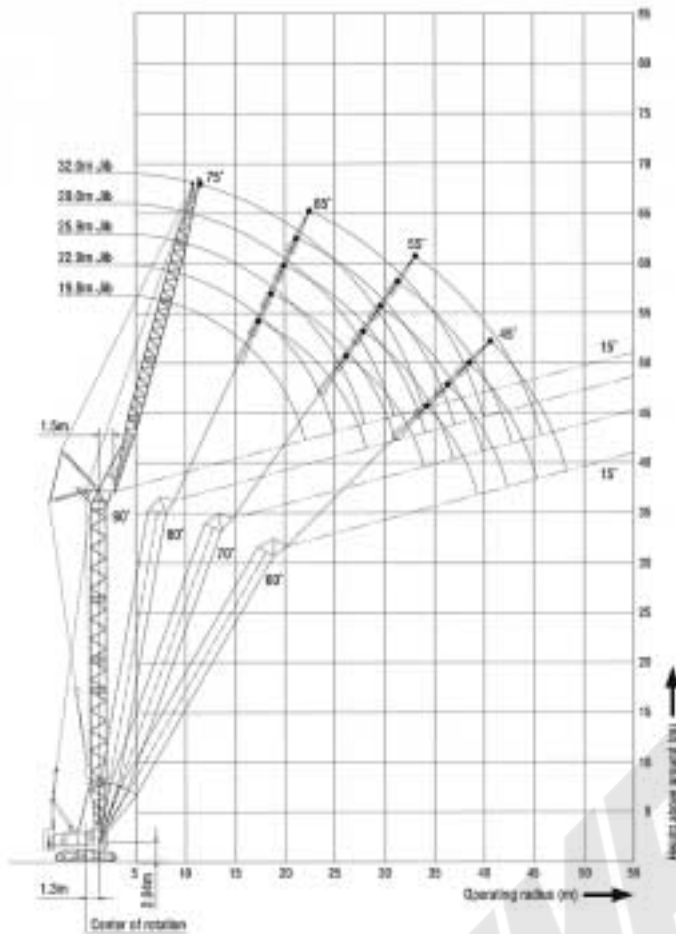

**Tower Length: 44.2 m**

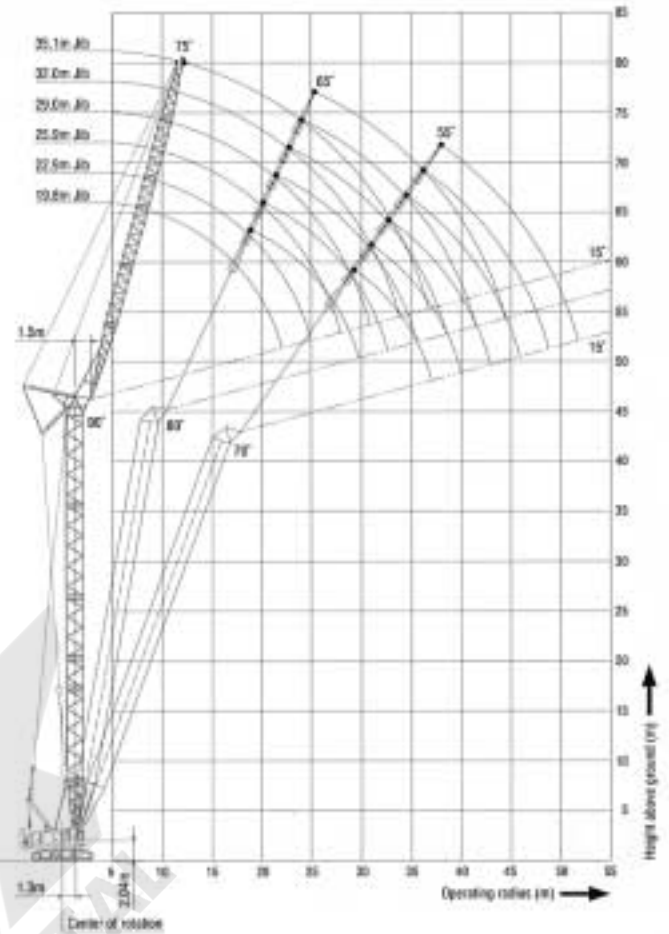

## Tower and Jib Arrangement

**Tower Arrangement Chart**

Boom length m (ft)	Boom arrangement
25.9 (85)	Base-D-C-Cap
29.0 (95)	Base-D-A-C-Cap
32.0 (105)	Base-D-A-A-C-Cap, Base-D-B-C-Cap
35.1 (115)	Base-D-A-B-C-Cap, Base-D-C-C-Cap
38.1 (125)	Base-D-A-A-B-C-Cap, Base-D-B-B-C-Cap, Base-D-A-C-C-Cap
41.1 (135)	Base-D-A-A-B-B-C-Cap, Base-D-B-C-C-Cap
44.2 (145)	Base-D-A-B-C-C-Cap

Base = 6.1 m (20'), Cap = 1.5 m (5')  
 Insert Tower: A = 3.0 m (10'), B = 6.1 m (20'), C = 9.1 m (30')  
 D = 9.1 m (30') with spreader support

**Jib Arrangement Chart**

Jib length m (ft)	Tower jib arrangement
19.8 (65)	Base-C-Tip
22.9 (75)	Base-C-A-Tip
25.9 (85)	Base-C-A-A-Tip, Base-C-B-Tip
29.0 (95)	Base-C-A-B-Tip
32.0 (105)	Base-C-A-A-B-Tip, Base-C-B-B-Tip
35.1 (115)	Base-C-A-B-B-Tip

Base = 7.6 m (25'), Tip = 6.1 m (20')  
 Insert Tower: A = 3.0 m (10'), B = 6.1 m (20'), C = 6.1 m (20'); Tapered jib

# Luffing Tower Lifting Capacities

Unit: metric ton

## Luffing Tower Rated loads in metric tons for 360° working area (Tower length: 25.9m/29.0 m)

Crawlers fully extended

Working radius (m)	25.9 m (85 ft) Tower					
	19.8m (65') Jib			22.9m (75') Jib		
	Tower angle			Tower angle		
	90°	75°	60°	90°	75°	60°
	15.0/8.2					
9.0	15.0			15.0/9.0		
10.0	15.0			15.0		
12.0	15.0			15.0		
14.0	15.0			15.0		
16.0	12.9			12.9		
18.0	11.0	9.7/19.6		11.0		
20.0	9.7	9.5		9.7	8.9/21.1	
22.0	8.5/22.0	8.6		8.5	8.4	
24.0		7.7		7.6	7.6	
26.0		6.9		7.1/24.9	6.8	
28.0		6.3	4.8/23.7		6.2	
30.0		6.1/28.7	4.8		5.7	4.3/31.9
32.0			4.4		5.3/31.6	4.3
34.0			4.1			4.0
36.0			3.9/34.8			3.7
38.0						3.4/37.7
40.0						
42.0						
44.0						

Working radius (m)	29.0 m (95 ft) Tower								
	19.8m (65') Jib			22.9m (75') Jib			25.9 m (85') Jib		
	Tower angle			Tower angle			Tower angle		
	90°	75°	60°	90°	75°	60°	90°	75°	60°
	15.0/8.2								
9.0	15.0			15.0/9.0					
10.0	15.0			15.0					
12.0	15.0			15.0					
14.0	15.0			15.0					
16.0	12.9			12.9					
18.0	11.0			11.0					
20.0	9.7	9.0/20.4		9.7	8.1/21.9				
22.0	8.5/22.0	8.3		8.5	8.1				
24.0		7.5		7.6	7.3				
26.0		6.7		7.1/24.9	6.6				
28.0		6.1			6.0				
30.0		5.6/29.4	4.3/31.3		5.5				
32.0			4.1		5.1	3.7/33.4			
34.0			3.8		4.9/32.4	3.6			
36.0			3.5			3.4			
38.0			3.4/36.3			3.1			
40.0						2.8/39.2			
42.0									
44.0									

Note: rating inside shown in  are determined by the strength of the boom or other structural components.

## Luffing Tower Rated loads in metric tons for 360° working area (Tower length: 32.0m)

Crawlers fully extended

Working radius (m)	32.0 m (105 ft) Tower												Working radius (m)
	19.8m (65') Jib			22.9m (75') Jib			25.9 m (85') Jib			29.0 m (95') Jib			
	Tower angle			Tower angle			Tower angle			Tower angle			
	90°	75°	60°	90°	75°	60°	90°	75°	60°	90°	75°	60°	
	15.0/8.2												
9.0	15.0			15.0/9.0			15.0/9.8						9.0
10.0	15.0			15.0			15.0			15.0/10.8			10.0
12.0	15.0			15.0			15.0			15.0			12.0
14.0	15.0			15.0			15.0			15.0			14.0
16.0	12.9			12.9			12.9			12.9			16.0
18.0	11.0			11.0			11.0			11.0			18.0
20.0	9.7	8.4/21.2		9.7			9.7			9.7			20.0
22.0	8.5/22.0	8.0		8.5	7.6/22.7		8.5			8.5			22.0
24.0		7.2		7.6	7.1		7.6	6.8/24.2		7.6	6.3/25.7		24.0
26.0		6.5		7.1/24.9	6.4		6.9	6.3		6.9	6.2		26.0
28.0		5.9			5.8		6.1/27.8	5.7		6.2	5.7		28.0
30.0		5.4			5.3			5.2		5.6	5.2		30.0
32.0		5.3/30.2	3.6/32.8		4.9			4.8		5.2/30.8	4.8		32.0
34.0			3.4		4.6/33.2	3.1/35.0		4.4			4.4		34.0
36.0			3.2			3.0		4.1	2.8/37.1		4.1		36.0
38.0			2.9/37.8			2.8		4.1/36.1	2.7		3.8	2.4/39.3	38.0
40.0						2.6			2.4		3.6/39.1	2.3	40.0
42.0						2.5/40.7			2.2			2.1	42.0
44.0									2.0/43.7			2.0	44.0
46.0												1.8	46.0
48.0												1.7/46.6	48.0

Note: rating inside shown in  are determined by the strength of the boom or other structural components.

## Luffing Tower Rated loads in metric tons for 360° working area (Tower length: 35.1m)

Crawlers fully extended

Working radius (m)	35.1 m (115 ft) Tower																Working radius (m)
	19.8m (65') Jib			22.9m (75') Jib			25.9 m (85') Jib			29.0 m (95') Jib			32.0 m (105') Jib				
	Tower angle			Tower angle			Tower angle			Tower angle			Tower angle				
	90°	75°	60°	90°	75°	60°	90°	75°	60°	90°	75°	60°	90°	80°	70°		
	15.0/8.2																
9.0	15.0			15.0/9.0			15.0/9.8										9.0
10.0	15.0			15.0			15.0			15.0/10.8			12.8/11.3				10.0
12.0	15.0			15.0			15.0			15.0			12.8				12.0
14.0	15.0			15.0			15.0			15.0			12.8				14.0
16.0	12.9			12.9			12.9			12.9			12.0				16.0
18.0	11.0			11.0			11.0			11.0			11.0				18.0
20.0	9.7			9.7			9.7			9.7			9.7				20.0
22.0	8.5/22.0	7.7/22.0		8.5	6.9/23.5		8.5			8.5			8.5	7.2/22.5			22.0
24.0		7.0		7.6	6.8		7.6	6.3/25.0		7.6			7.6	6.8			24.0
26.0		6.3		7.1/24.9	6.2		6.9	6.1		6.9	5.8/28.5		6.9	6.1			26.0
28.0		5.7			5.6		6.1/27.8	5.5		6.2	5.5		6.2	5.6			28.0
30.0		5.2			5.1			5.1		5.6	5.0		5.7	5.1			30.0
32.0		4.9/31.0			4.7			4.6		5.2/30.8	4.6		5.1	4.7	3.7/33.3		32.0
34.0			3.0/34.3		4.3/34.0			4.3			4.2		4.5/33.7	4.3	3.6		34.0
36.0			2.8			2.5/36.5		3.9			3.9			4.0	3.3		36.0
38.0			2.6			2.4		3.7/36.9	2.1/38.6		3.6			3.7	3.1		38.0
40.0			2.5/39.3			2.2			2.0		3.3/39.9	1.9/40.8		3.4/39.8	2.8		40.0
42.0						2.0			1.9			1.9			2.6		42.0
44.0						2.0/42.3			1.7			1.8			2.4		44.0
46.0									1.6/45.2			1.6			2.2/45.7		46.0
48.0												1.5/47.0					48.0

 Note: rating inside shown in  are determined by the strength of the boom or other structural components.

## Luffing Tower Rated loads in metric tons for 360° working area (Tower length: 38.1m)

Crawlers fully extended

Working radius (m)	38.1 m (125 ft) Tower																	
	19.8m (65') Jib			22.9m (75') Jib			25.9 m (85') Jib			29.0 m (95') Jib			32.0 m (105') Jib			35.1 m (115') Jib		
	Tower angle			Tower angle			Tower angle			Tower angle			Tower angle			Tower angle		
	90°	75°	60°	90°	75°	60°	90°	80°	70°	90°	80°	70°	90°	80°	70°	90°	80°	70°
	15.0/8.2																	
9.0	15.0			15.0/9.0			15.0/9.8											
10.0	15.0			15.0			15.0			15.0/10.8			12.8/11.3					
12.0	15.0			15.0			15.0			15.0			12.8			10.5/12.1		
14.0	15.0			15.0			15.0			15.0			12.8			10.5		
16.0	12.9			12.9			12.9			12.9			12.0			10.1		
18.0	11.0			11.0			11.0			11.0			11.0			9.5		
20.0	9.7			9.7			9.7	8.1/20.6		9.7	7.5/21.9		9.7			9.0		
22.0	8.5/22.0	7.1/22.7		8.5			8.5	7.6		8.5	7.5		8.5	6.9/23.2		8.5		
24.0		6.7		7.6	6.4/24.3		7.6	6.8		7.6	6.7		7.6	6.6		7.6	6.3/24.4	
26.0		6.1		7.1/24.9	5.9		6.9	6.1		6.9	6.1		6.9	6.0		6.9	5.9	
28.0		5.5			5.4		6.1/27.8	5.6		6.2	5.5		6.2	5.4		6.2	5.3	
30.0		5.0			4.9			5.1	4.0/30.8	5.6	5.1		5.7	4.9		5.7	4.9	
32.0		4.6/31.8			4.5			4.7	3.8	5.2/30.8	4.6	3.7/32.6	5.1	4.5		5.2	4.5	
34.0			2.3/35.8		4.2			4.3	3.5		4.3	3.5	4.5/33.7	4.2	3.2/34.3	4.7	4.1	
36.0			2.3		4.0/34.8			4.2/34.5	3.3		4.0	3.2		3.9	3.0	4.1	3.8	
38.0			2.1			1.9/38.0			3.0		3.8/37.4	2.9		3.6	2.8	3.8/36.7	3.5	
40.0			1.9			1.8			2.8			2.7		3.3	2.6		3.3	
42.0			1.7/40.9			1.6			2.7/40.8			2.5		3.2/40.4	2.3		3.0	
44.0						1.5/43.0						2.3/43.8			2.1		2.8/43.3	
46.0															2.0		1.9	
48.0															1.9/46.7		1.7	
50.0																	1.5/49.7	

 Note: rating inside shown in  are determined by the strength of the boom or other structural components.

# Luffing Tower Lifting Capacities

Unit: metric ton

## Luffing Tower Rated loads in metric tons for 360° working area (Tower length: 41.1m)

Crawlers fully extended

Working radius (m)	41.1 m (135 ft) Tower																				
	19.8m (65') Jib			22.9m (75') Jib			25.9 m (85') Jib			29.0 m (95') Jib			32.0 m (105') Jib			35.1 m (115') Jib					
	Tower angle			Tower angle			Tower angle			Tower angle			Tower angle			Tower angle					
	90°	75°	60°	90°	80°	60°	90°	80°	70°	90°	80°	70°	90°	80°	70°	90°	80°	70°			
	15.082																				
9.0	15.0			15.09.0			15.09.8														
10.0	15.0			15.0			15.0			15.0/10.6			12.8/11.3								
12.0	15.0			15.0			15.0			15.0			12.8					10.5/12.1			
14.0	15.0			15.0			15.0			15.0			12.8					10.5			
16.0	12.9			12.9			12.9			12.9			12.0					10.1			
18.0	11.0			11.0	8.3/19.8		11.0			11.0			11.0					9.5			
20.0	9.7			9.7	8.3		9.7	7.8/21.1		9.7			9.7					9.0			
22.0	8.5/22.0	6.5/23.5		8.5	7.5		8.5	7.4		8.5	7.0/22.4		8.5	6.5/23.7				8.5			
24.0		6.3		7.6	6.7		7.6	6.6		7.6	6.6		7.6	6.4				7.6	5.9/25.0		
26.0		5.8		7.1/24.9	6.1		6.9	6.0		6.9	5.9		6.9	5.8				6.9	5.7		
28.0		5.3			5.5		6.1/27.8	5.5		6.2	5.4		6.2	5.3				6.2	5.2		
30.0		4.8			5.1	4.0/30.1		5.0	3.6/31.9		5.6	4.9		5.7	4.8			5.7	4.7		
32.0		4.4			4.6	3.7		4.8	3.6	5.2/30.8	4.5	3.3/33.6		5.1	4.4			5.2	4.3		
34.0		4.3/32.6			4.6/32.1	3.4		4.2	3.3		4.2	3.2	4.5/33.7	4.1	2.8/35.4			4.7	4.0		
36.0			1.7/37.4			3.1		4.0/35.0	3.0		3.9	2.9		3.8	2.7			4.1	3.7	2.5/37.1	
38.0			1.7			2.9			2.8		3.6/38.0	2.7		3.5	2.5	3.8/36.7		3.4	2.4		
40.0			1.6			2.8/38.9			2.5			2.4		3.2	2.3			3.2	2.2		
42.0			1.5/41.0						2.3/41.9			2.2		3.0/40.9	2.1			2.9	2.0		
44.0												2.0			1.9			2.7/43.6	1.8		
46.0												1.9/44.8			1.7				1.8		
48.0															1.6/47.8					1.5/48.0	
50.0																					

Note: rating inside shown in  are determined by the strength of the boom or other structural components.

## Luffing Tower Rated loads in metric tons for 360° working area (Tower length: 44.2 m)

Crawlers fully extended

Working radius (m)	44.2 m (145 ft) Tower																				
	19.8m (65') Jib			22.9m (75') Jib			25.9 m (85') Jib			29.0 m (95') Jib			32.0 m (105') Jib			35.1 m (115') Jib					
	Tower angle			Tower angle			Tower angle			Tower angle			Tower angle			Tower angle					
	90°	80°	70°	90°	80°	70°	90°	80°	70°	90°	80°	70°	90°	80°	70°	90°	80°	70°			
	15.082																				
9.0	15.0			15.09.0			15.09.8														
10.0	15.0			15.0			15.0			15.0/10.6			12.8/11.3								
12.0	15.0			15.0			15.0			15.0			12.8					10.5/12.1			
14.0	15.0			15.0			15.0			15.0			12.8					10.5			
16.0	12.9			12.9			12.9			12.9			12.0					10.1			
18.0	11.0	8.6/19.1		11.0			11.0			11.0			11.0					9.5			
20.0	9.7	8.2		9.7	7.9/20.4		9.7	7.4/21.6		9.7			9.7					9.0			
22.0	8.5/22.0	7.4		8.5	7.3		8.5	7.2		8.5	6.7/22.7		8.5					8.5			
24.0		6.7		7.6	6.5		7.6	6.4		7.6	6.4		7.6	6.1/24.2				7.6	5.6/25.5		
26.0		6.0		7.1/24.9	5.9		6.9	5.8		6.9	5.7		6.9	5.6				6.9	5.5		
28.0		5.5	4.0/29.4		5.4		6.1/27.8	5.3		6.2	5.2		6.2	5.1				6.2	5.0		
30.0		5.0/29.7	3.9		4.9	3.5/31.2		4.8		5.6	4.8		5.7	4.7				5.7	4.6		
32.0			3.5		4.5	3.4		4.4	3.0/32.9	5.2/30.8	4.4		5.1	4.3				5.2	4.2		
34.0			3.2		4.4/32.6	3.1		4.1	2.9		4.0	2.8/34.7	4.5/33.7	3.9				4.7	3.9		
36.0			2.9			2.8		4.0/35.5	2.6		3.7	2.5		3.6	2.2/38.4			4.1	3.6		
38.0			2.7/37.0			2.5			2.4		3.4	2.3		3.4	2.1	3.8/36.7		3.3	2.0/38.1		
40.0						2.3/40.0			2.2		3.3/38.5	2.1		3.1	1.9			3.1	1.8		
42.0									2.0			1.9		3.0/41.4	1.7			2.8	1.6		
44.0									1.9/42.9			1.7			1.6			2.6/44.0	1.5/44.0		
46.0												1.6/45.7			1.5/45.0						

Note: rating inside shown in  are determined by the strength of the boom or other structural components.

## Clamshell

Clamshell ratings in metric tons for 360° working area (Crawlers fully extended)

Unit: metric ton

Working radius m	Boom length m (ft)	12.2 (40)	15.2 (50)	18.3 (60)	21.3 (70)
5.0		10.0			
6.0		10.0	10.0		
7.0		10.0	10.0	10.0	
8.0		10.0	10.0	10.0	10.0
9.0		10.0	10.0	10.0	10.0
10.0		10.0	10.0	10.0	10.0
12.0		10.0	10.0	10.0	10.0
14.0			10.0	10.0	10.0
16.0				10.0	10.0
18.0					8.6

## Working Range

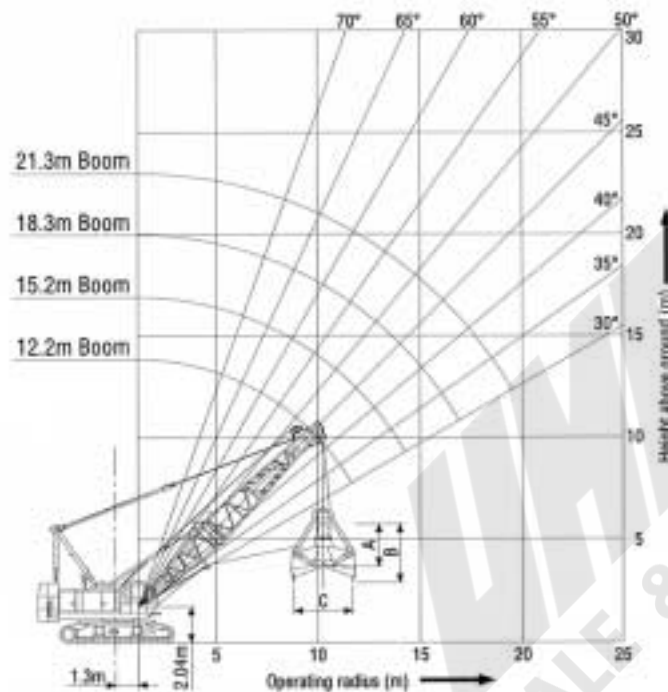

### Note:

1. Working radius is the horizontal distance between the center of rotation and the bucket's center of gravity.
2. Total weight of bucket and materials must not exceed rated load.

### Example of calculation:

**Bucket capacity x Specific gravity of materials + Bucket weight = Rated load.** (2.0 m<sup>3</sup> x 1.8 ton/m<sup>3</sup> + 3.8 ton = 7.4 ton)

3. Rating are determined from stability and strength of boom. During swing, avoid sudden starts and stops that exert horizontal pulling load on boom. Particular caution is advised with long-length booms.
4. Rated loads are determined by degree of stability. During simultaneous operations of boom and swing, rapid acceleration or deceleration must be avoided. Particular care is required with long boom lengths.
5. Bucket weight must not exceed 5.5 tons.

## Clamshell Bucket

Bucket capacity (m <sup>3</sup> )	Approximate weight (ton)	Bucket dimensions (m)			Application
		A	B	C	
1.6	3.2	3.3	3.6	3.0	Loading
2.0	3.8	3.5	3.9	3.1	Loading
1.25	3.6	2.9	3.7	3.0	Digging
1.6	4.6	3.2	4.0	3.2	Digging

## Diaphragm Wall Bucket



Note: For details of specifications, please consult with your nearest dealers.

**KOBELCO**  
**HYDRAULIC CRAWLER CRANE**  
**7080.2**

**UMAK**  
SALE & RENTAL

Due to our policy of continual product improvements all designs and specifications are subject to change without advanced notice.

---

**KOBELCO CONSTRUCTION MACHINERY CO., LTD.**

3-13, Nihonbashi 1-chome, Chuo-ku, TOKYO, 103-8246 JAPAN  
Tel: (03)3278-7080/ Fax: (03)3278-7141