

Hydraulic Crawler Crane

7250S

Model : 7250S

- Max. Lifting Capacity: **250 t x 4.6 m**
- Max. Lifting Capacity With Tower Jib: **25.0 t x 18.0 m**
- Max. Crane Boom Length: **76.2 m**
- Max. Long Boom Length: **91.4 m**
- Max. Fixed Jib Combination: **76.2 m + 30.5 m**
- Max. Tower Jib Combination: **64.1 m + 51.8 m**

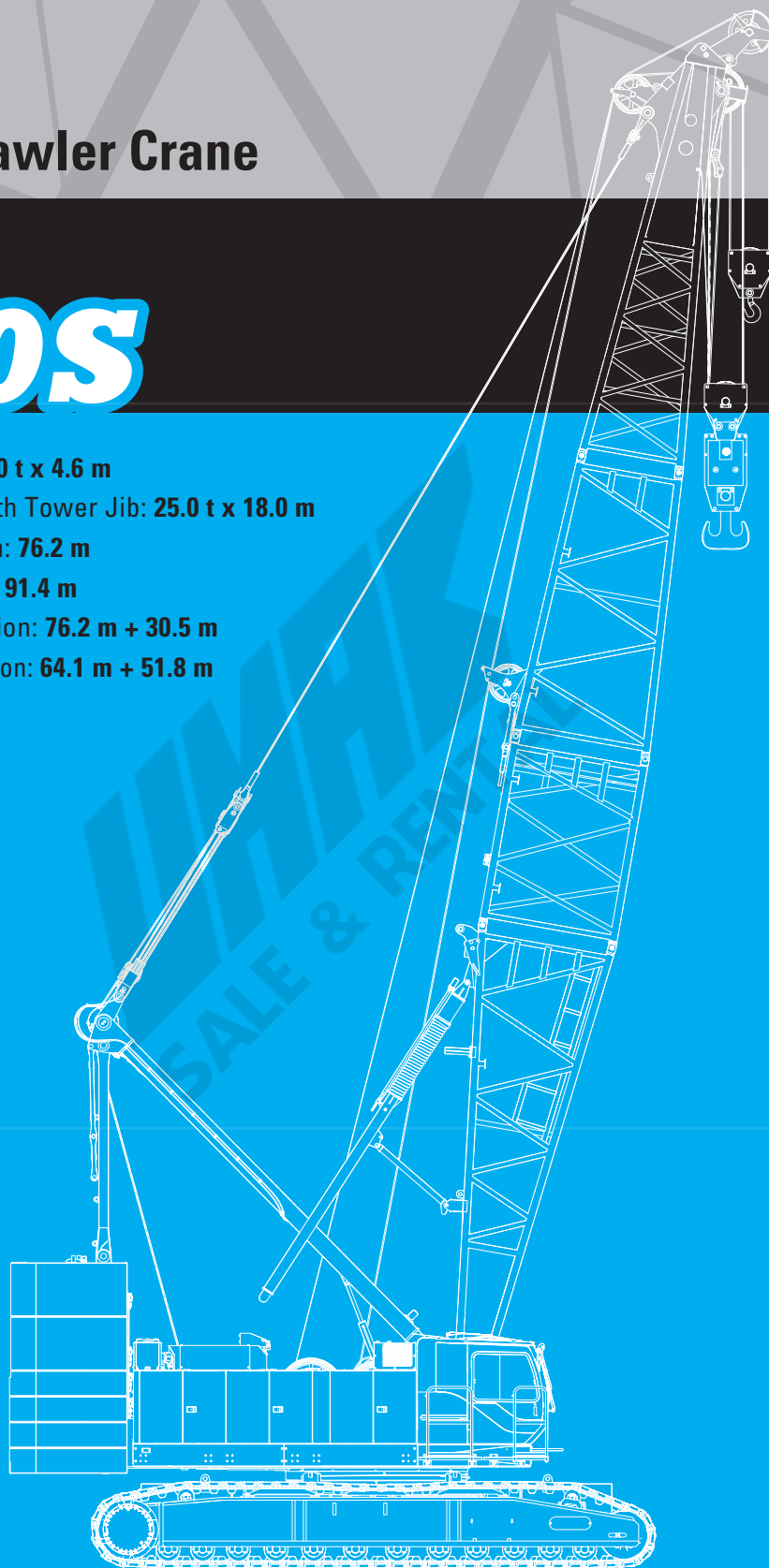

KOBELCO

UMAX
SALE & RENTAL

7250S CONTENTS

3	SPECIFICATIONS
5	GENERAL DIMENSIONS
7	BOOM AND JIB ARRANGEMENTS
11	WORKING RANGES
16	SUPPLEMENTAL DATA
17	LIFTING CAPACITIES
23	SUPPLEMENTAL DATA
24	LIFTING CAPACITIES
36	SUPPLEMENTAL DATA FOR CLAMSHELL
37	LIFTING CAPACITIES
38	SUPPLEMENTAL DATA FOR REDUCED WEIGHTS
39	LIFTING CAPACITIES
40	SUPPLEMENTAL DATA FOR BARGE
41	LIFTING CAPACITIES
42	TRANSPORTATION PLAN
43	PARTS AND ATTACHMENTS

SPECIFICATIONS



Power Plant

Model: HINO P11C-VH

Type: 4 cycle, water-cooled, vertical in-line 6, direct injection, turbo-charger, intercooler

Displacement: 10,520 liters

Rated power: 271 kW/1,850 min⁻¹

Max. Torque: 1,469 N·m/1,400 min⁻¹

Cooling System: Water-cooled

Starter: 24 V-6 kW

Radiator: Corrugated type core, thermostatically controlled

Air cleaner: Dry type with replaceable paper element

Throttle: Twist grip type hand throttle, electrically actuated

Fuel filter: Replaceable paper element

Batteries: Two 12 V x 136 Ah/5 HR capacity batteries, series connected

Fuel tank capacity: 400 liters



Hydraulic System

Main pumps: 4 variable displacement piston pumps

Control: Full-flow hydraulic control system for infinitely variable pressure to all winches, propel and swing. Controls respond instantly to the touch, delivering smooth function operation.

Cooling: Oil-to-air heat exchanger (plate-fin type)

Filtration: Full-flow and bypass type with replaceable element

Max. relief valve pressure:

Load hoist, boom hoist and propel system: 31.9 MPa

Swing system: 27.5 MPa

Control system: 5.4 MPa

Hydraulic Tank Capacity: 650 liters



Boom Hoisting System

Powered by a hydraulic motor through a planetary reducer.

Brake: A spring-set, hydraulically released multiple-disc brake is mounted on the boom hoist motor and operated through a counter-balance valve.

Drum Lock: External ratchet for locking drum

Drum: Double drum, grooved for 22 mm dia. wire rope

Line Speed: Single line on first drum layer

Hoisting/Lowering: 26 to 2 m/min

Boom hoisting/lowering: 22 mm x 280 m

Boom guy line: 38 mm

Boom backstops: Required for all boom length



Load Hoisting System

Front and rear drums for load hoist powered by a hydraulic variable plunger motors, driven through planetary reducers.

Negative Brake: A spring-set, hydraulically released multiple-disc brake is mounted on the hoist motor and operated through a counter-balance valve. (Positive free fall brake is optional)

Drum Lock: External ratchet for locking drum

Drums:

Front Drums:

620 mm P.C.D x 841 mm wide drum, grooved for 28 mm wire rope. Rope capacity is 390 m working length and 470 m storage length.

Rear Drum: 620 mm P.C.D x 576 mm, grooved for 28 mm wire rope. Rope capacity is 220 m working length and 318 m storage length.

Diameter of wire rope

Main winch: 28 mm x 390 m

Aux. winch: 28 mm x 220 m

Line Speed*:

Hoisting/lowering: 110 to 3 m/min

Line Pull:

Max. Line Pull* : 251 kN {25.6 tf}
(Referential performance)

Rated Line Pull: 132 kN {13.5 tf}

*Single line on first drum layer



Swing System

Swing unit is powered by hydraulic motor driving spur gears through planetary reducers (2 set), the swing system provides 360° rotation.

Swing parking brakes: A spring-set, hydraulically released multiple-disc brake is mounted on swing motor.

Swing circle: Single-row ball bearing with an integral internally cut swing gear.

Swing lock: Manually, four position lock for transportation

Swing Speed: 2.2 min⁻¹



Upper Structure

Torsion-free precision machined upper frame. All components are located clearly and service friendly. Engine will with low noise level.

Counterweight: 97.1 ton



Cab & Control

Totally enclosed, full vision cab with safety glass, fully adjustable, high backed seat with a headrest and armrests, and intermittent wiper and window washer (skylight and front window).

Cab fittings:

Air conditioner, convenient compartment (for tool), cup holder, cigarette lighter, sun visor, roof blind, tinted glass, floor mat, footrest, and shoe tray



Lower Structure

Steel-welded carbody with axles. Crawler assemblies are designed with quick disconnect feature for individual removal as a unit from axles. Crawler belt tension is maintained by hydraulic jack force on the track adjusting bearing block.

Carbodyweight: 23.1 ton

Crawler drive: Independent hydraulic propel drive is built into each crawler side frame. Each drive consists of a hydraulic motor propelling a driving tumbler through a planetary gear box. Hydraulic motor and gear box are built into the crawler side frame within the shoe width.

Crawler brakes: Spring-set, hydraulically released parking brakes are built into each propel drive.

Steering mechanism: A hydraulic propel system provides both skid steering (driving one track only) and counter-rotating steering (driving each track in opposite directions).

Track rollers: Sealed track rollers for maintenance-free operation.

Shoe (flat): 1,070 mm wide each crawler

Max. gradeability: 30 %



Weight

Including upper and lower machine, 97.1 ton counterweight and 23.1 ton carbody weight, basic boom (or basic boom + basic jib), hook, and other accessories.

Weight: 212 ton

Ground pressure: 123 kPa



Attachment

Boom & Jib:

Welded lattice construction using tubular, high-tensile steel chords with pin connection between sections.

Boom and Jib length

	Min. Length (Min. combination)	Max. Length (Max. combination)
Crane Boom	15.2 m	76.2 m
Fixed Jib	42.7 m + 12.2 m	76.2 m + 30.5 m

Main Specifications (Model: 7250S)

Crane Boom	
Max. Lifting Capacity	250 t x 4.6 m
Max. Length	76.2 m
Fixed Jib	
Max. Lifting Capacity	22.7 t x 15.0 m
Max. Combination	76.2 m + 30.5 m
Long Boom	
Max. Lifting Capacity	37.5 t x 14.4 m
Max. Length	91.4 m
Tower Jib	
Max. Jib Length	51.8 m
Max. Combination	64.1 m + 51.8 m
Main & Aux. Winch	
Max. Line Speed (1st layer)	110 m/min
Rated Line Pull (Single line)	132 kN {13.5 tf}
Wire Rope Diameter	28 mm
Wire Rope Length	390 m (Main), 220 m (Aux.)
Brake Type (Free fall)	Wet-type multiple disc brake (Optional)
Working Speed	
Swing Speed	2.2 min ⁻¹ {rpm}
Travel Speed	1.0/0.5 km/h

Power Plant	
Model	HINO P11C-VH
Engine Output	271 kW/1,850 min ⁻¹
Fuel Tank	400 liters
Hydraulic System	
Main Pumps	4 variable displacement
Max. Pressure	31.9 MPa {325 kgf/cm ² }
Hydraulic Tank Capacity	650 liters
Self-Removal Device	
	NA
Weight	
Operating Weight	212 t *1
Ground Pressure	123 kPa
Counterweight	97,100 kg
Transport Weight	45,200 kg *2

Units are SI units. { } indicates conventional units.

Line speeds in table are for light loads. Line speed varies with load.

*1 Including upper and lower machine, 97.1 ton counterweight, 23.1 ton carbody weight, basic boom, hook, and other accessories.

*2 Base Machine with boom base, gantry, wire ropes (front/boom hoist)

GENERAL DIMENSIONS

(Unit: mm)

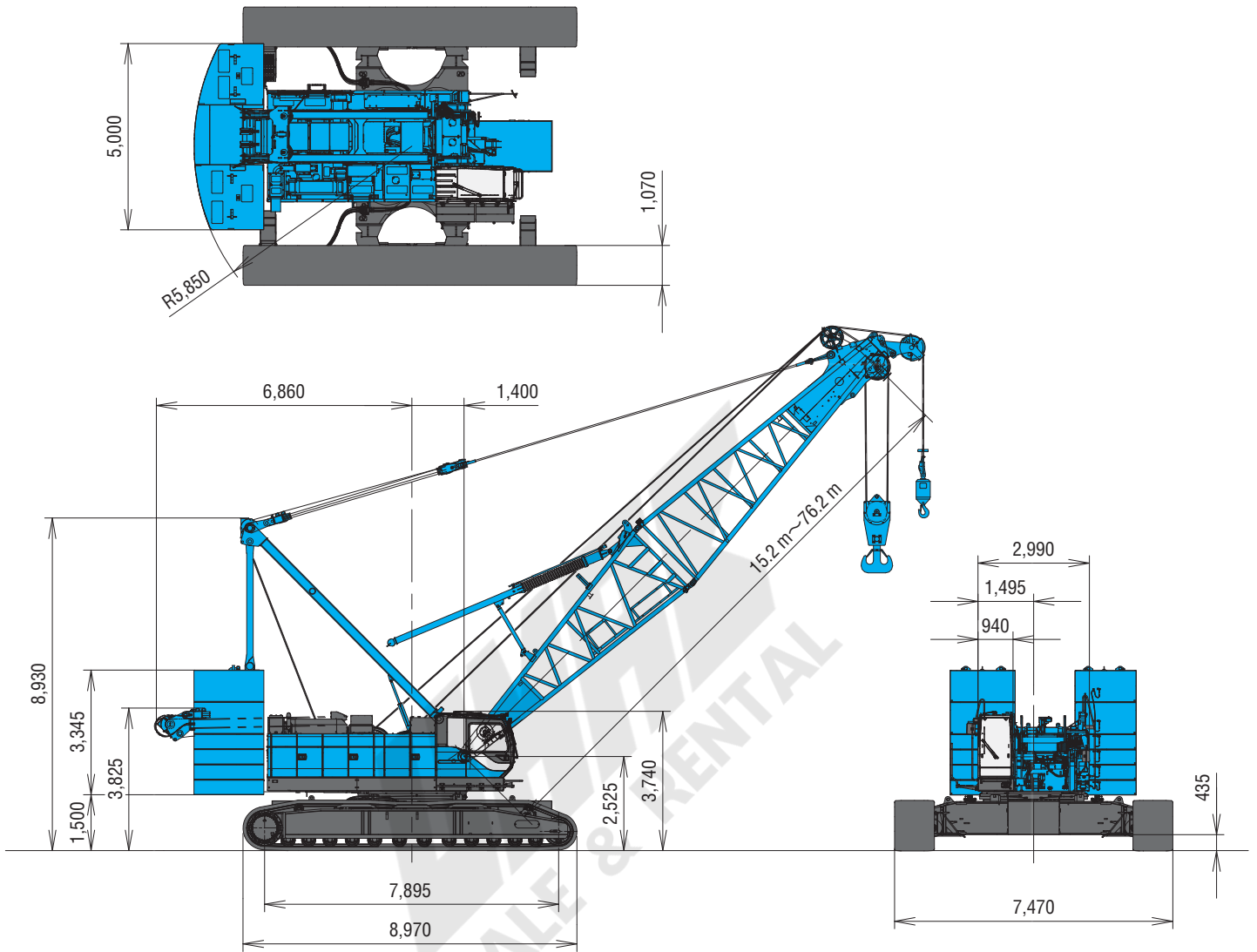

Limit of Hook Lifting

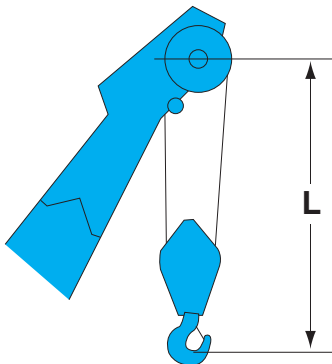

Hook	L
250 t hook	5.3 m
150 t hook	5.9 m
70 t hook	4.9 m
35 t hook	4.7 m

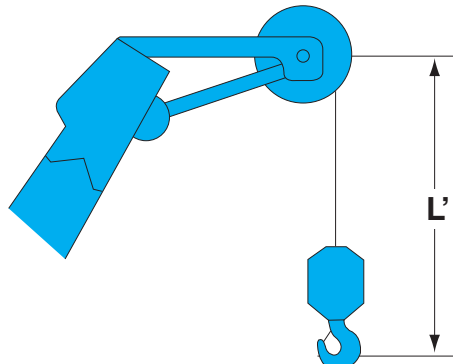

Hook	L'
Ball hook	3.2 m

Luffing Jib



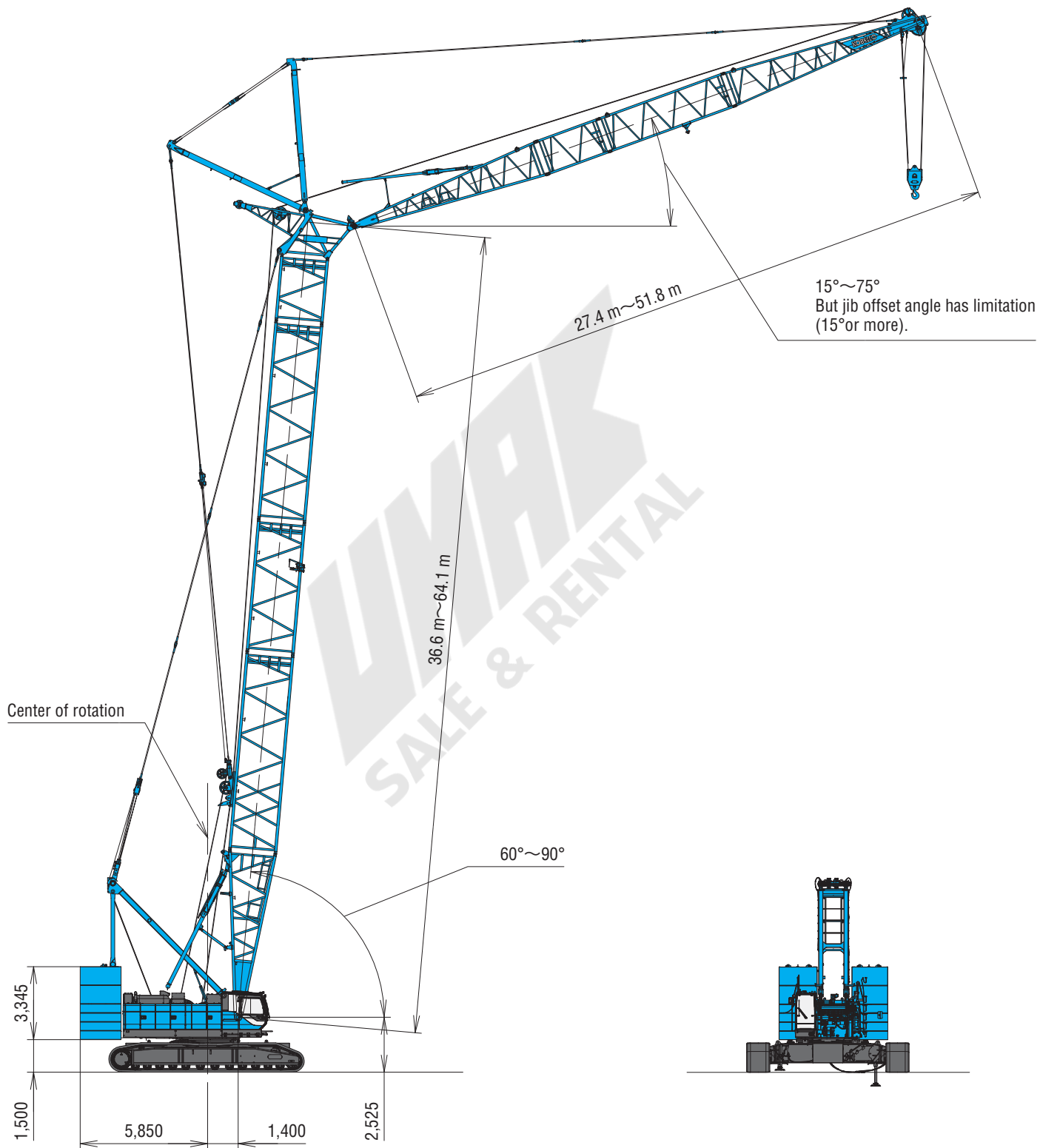





(Unit: mm)

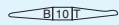
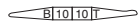
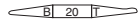
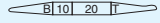
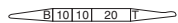

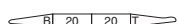
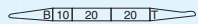
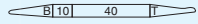
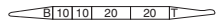
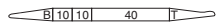

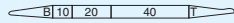

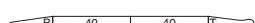
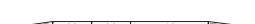
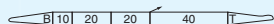
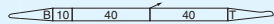
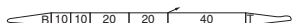



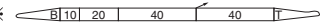
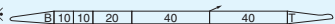
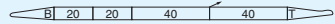
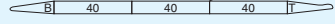

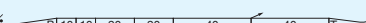
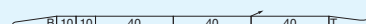
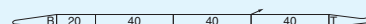

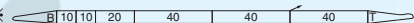
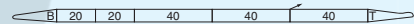
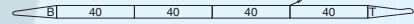
This catalog may contain photographs of machines with specifications, attachments and optional equipment.

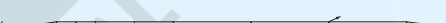
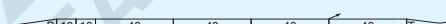
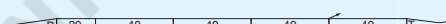
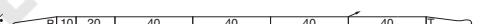
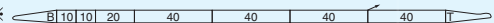
BOOM AND JIB ARRANGEMENTS

Crane Boom Arrangements

Boom length m (ft)	Boom arrangement
15.2 (50)	
18.3 (60)	
21.3 (70)	※  
24.4 (80)	※ 
27.4 (90)	※   
30.5 (100)	※  
33.5 (110)	※   
36.6 (120)	※ 
39.5 (130)	※   
42.7 (140)	※  
45.7 (150)	※   

Boom length m (ft)	Boom arrangement
48.8 (160)	※ 
51.8 (170)	※   
54.9 (180)	※  
57.9 (190)	※   
61.0 (200)	※ 
64.0 (210)	※   
67.1 (220)	※  
70.1 (230)	※   
73.2 (240)	※ 
76.2 (250)	※ 

Symbol	Boom Length	Remarks
	7.6 m	Boom Base
	7.6 m	Boom Top
	3.0 m	Insert Boom
	6.1 m	Insert Boom
	12.2 m	Insert Boom

↗ mark shows the guy line installing position when the fixed jib is used.

※ Indicates the most flexible combination of insert booms, which can be modified to form all shorter boom arrangements.

Long Boom Arrangements

Boom length m (ft)	Boom arrangement
73.2 (240)	
76.2 (250)	※
79.2 (260)	※
82.3 (270)	※
85.3 (280)	※
88.4 (290)	※
91.4 (300)	※

Symbol	Long Boom Length	Remarks
	7.6 m	Boom Base
	9.1 m	Tower Jib Top
	3.0 m	Insert Boom
	12.2 m	Insert Boom
	4.6 m	Tapered Boom
	3.0 m	Relay Jib
	3.0 m	Tower Insert Jib
	6.1 m	Tower Insert Jib
	9.1 m	Tower Insert Jib

※ Indicates the most flexible combination of insert long booms, which can be modified to form all shorter long boom arrangements.

Fixed Jib Arrangements

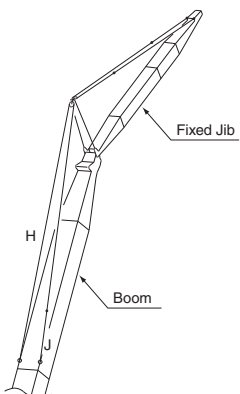

Crane boom length	Jib length m (ft)	Jib arrangement
42.7 m ~ 76.2 m	12.2 (40)	
	18.3 (60)	
	24.4 (80)	
	30.5 (100)	

Symbol	Jib Length	Remarks
	4.6 m	Jib Base
	4.6 m	Jib Top
	3.0 m	Insert Jib
	6.1 m	Insert Jib

BOOM AND JIB ARRANGEMENTS

Tower Arrangements

Tower length m (ft)	Tower arrangement
36.6 (120)	<p>Rail for upper spreader of luffing jib</p>
39.7 (130)	※
42.7 (140)	※
45.8 (150)	※
48.8 (160)	※

Tower length m (ft)	Tower arrangement
51.9 (170)	※
54.9 (180)	※
58.0 (190)	※
61.0 (200)	※
64.1 (210)	※

Symbol	Tower Length	Remarks
	7.6 m	Boom Base
	1.6 m	Tower Cap
	3.0 m	Insert Boom
	6.1 m	Insert Boom
	9.1 m	Special Insert Boom for Tower
	12.2 m	Insert Boom

※ Indicates the most flexible combination of insert towers, which can be modified to form all shorter tower arrangements.

Tower Jib Arrangements

Jib length m (ft)	Jib arrangement
27.4 (90)	
30.5 (100)	※
33.5 (110)	※
36.6 (120)	※
39.6 (130)	※

Jib length m (ft)	Jib arrangement
42.7 (140)	※
45.7 (150)	※
48.8 (160)	※
51.8 (170)	※

Symbol	Tower Jib Length	Remarks
	9.1 m	Tower Jib Base
	9.1 m	Tower Jib Top
	3.0 m	Relay Jib
	3.0 m	Tower Insert Jib
	6.1 m	Tower Insert Jib
	9.1 m	Tower Insert Jib

※ Indicates the most flexible combination of insert tower jibs, which can be modified to form all shorter tower jib arrangements.
 ⊙ mark: indicates position where cable rollers attached.

Tower and Jib Combinations and Allowable Tower Angle

Tower length	Jib length									
	27.4 m	30.5 m	33.5 m	36.6 m	39.6 m	42.7 m	45.7 m	48.8 m	51.8 m	Pillow plate
36.6 m	90°-60°	90°-60°	—	—	—	—	—	—	—	—
39.7 m	90°-60°	90°-60°	90°-60°	—	—	—	—	—	—	—
42.7 m	90°-60°	90°-60°	90°-60°	90°-60°	—	—	—	—	—	—
45.8 m	90°-60°	90°-60°	90°-60°	90°-60°	90°-60°	—	—	—	—	—
48.8 m	90°-60°	90°-60°	90°-60°	90°-60°	90°-60°	90°-60°	90°-60°	—	—	—
51.9 m	90°-60°	90°-60°	90°-60°	90°-60°	90°-60°	90°-60°	90°-60°	90°-60°	—	—
54.9 m	90°-60°	90°-60°	90°-60°	90°-60°	90°-60°	90°-60°	90°-60°	90°-60°	90°-60°	—
58.0 m	90°-60°	90°-60°	90°-60°	90°-60°	90°-60°	90°-60°	90°-60°	90°-60°	90°-60°	90°-70°
61.0 m	90°-60°	90°-60°	90°-60°	90°-60°	90°-60°	90°-60°	90°-60°	90°-60°	90°-60°	90°-70°
64.1 m	90°-60°	90°-60°	90°-60°	90°-60°	90°-60°	90°-60°	90°-70°	90°-70°	90°-70°	90°-70°
Hook	35 ton hook	○	○	○	○	○	○	○	○	Need
	Ball hook	×	○	○	○	○	○	○	○	

○ : Available
 × : Not available

WORKING RANGES

Crane Boom

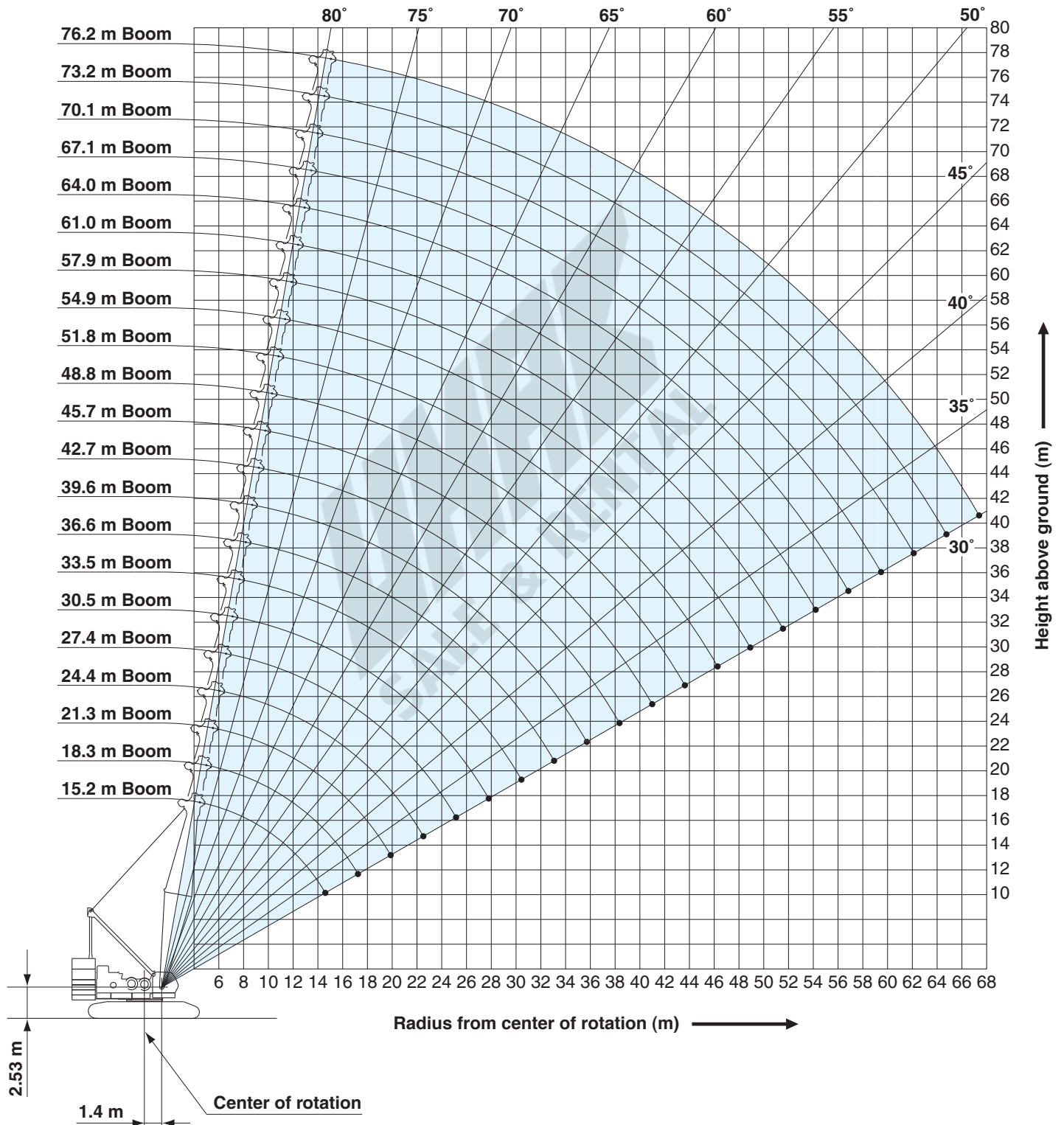

Fixed Jib 10°, 30°

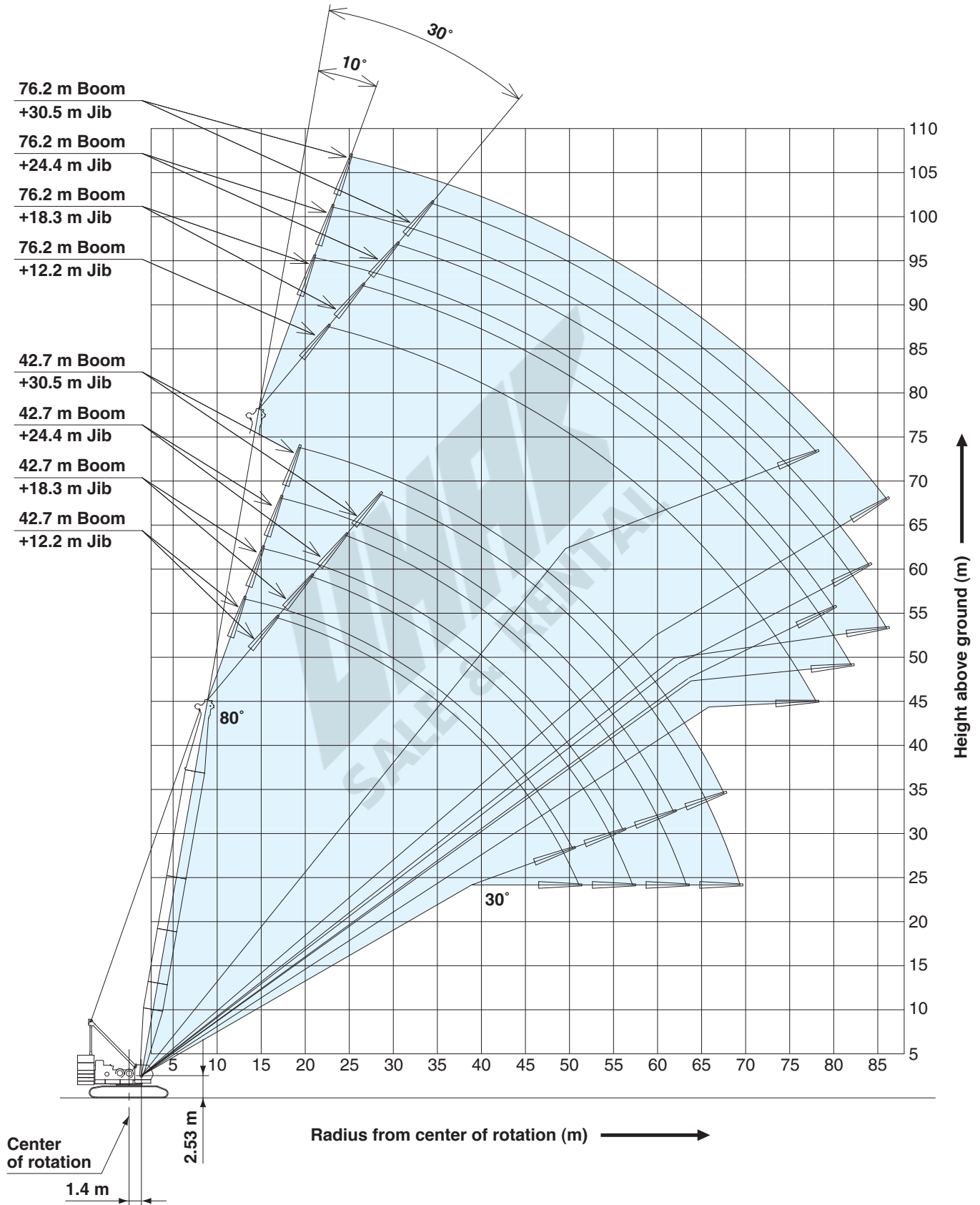

WORKING RANGES

Long Boom

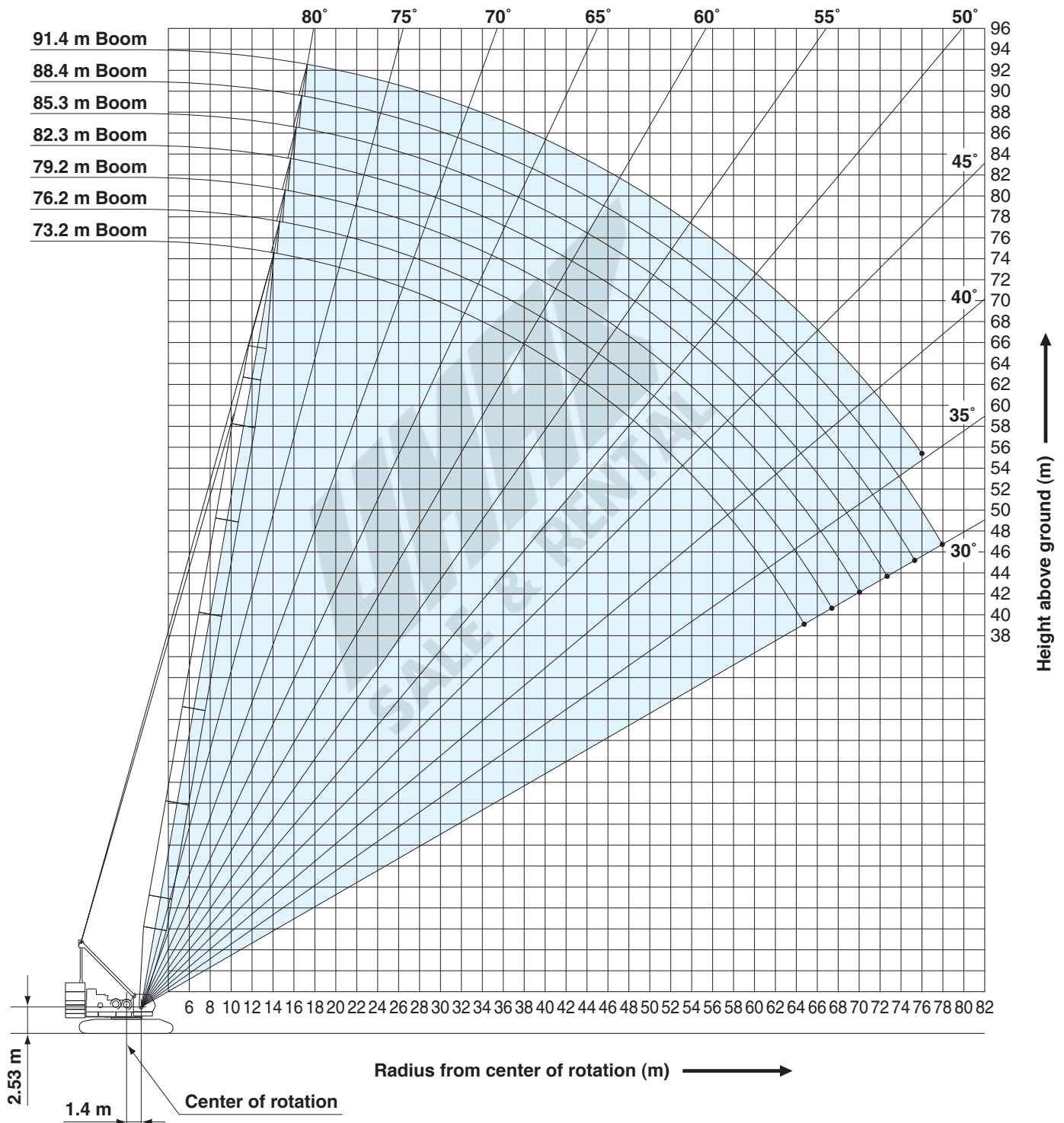

Tower Jib

Tower Length: 48.8 m

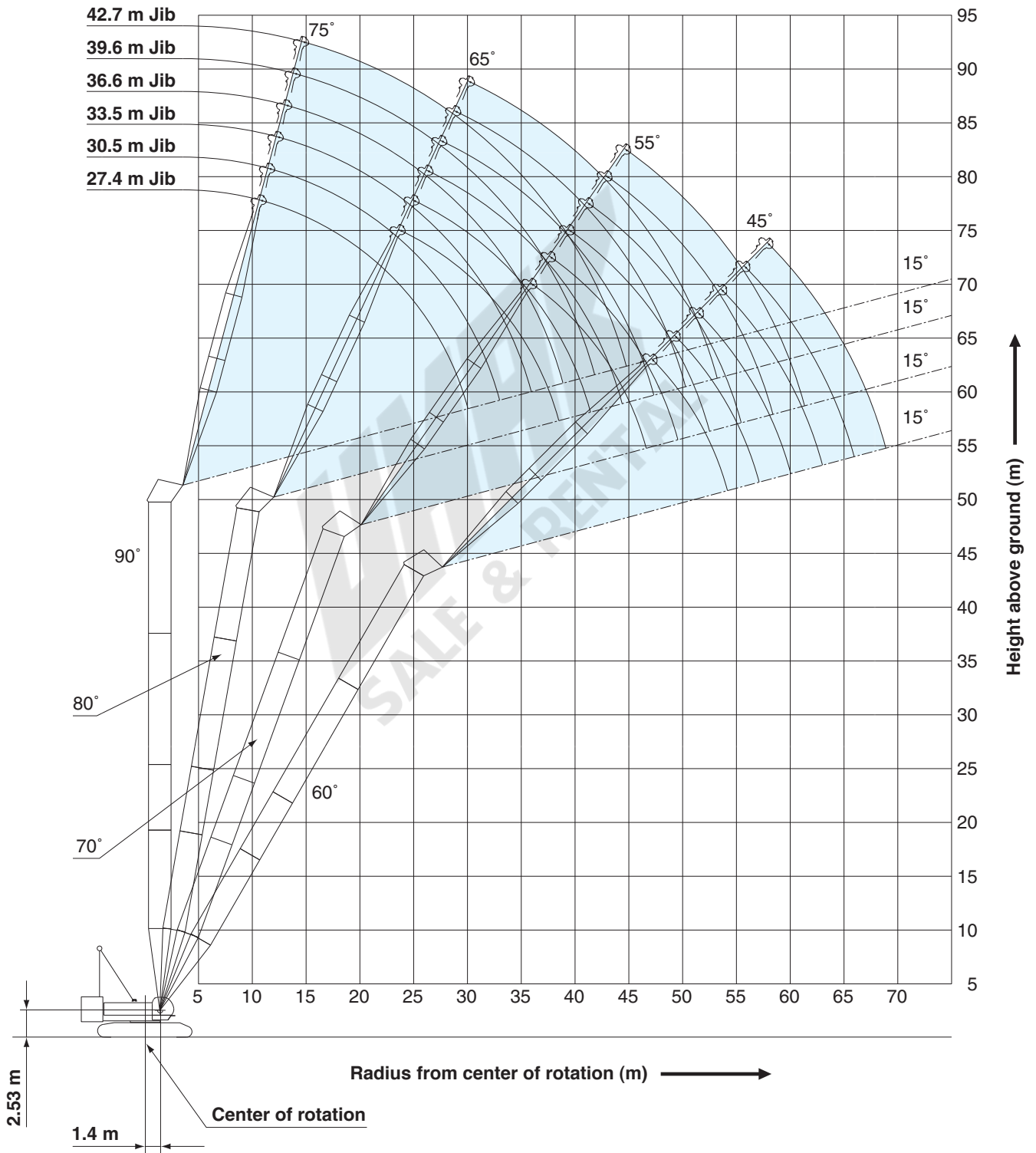

WORKING RANGES

Tower Jib

Tower Length: 64.1 m

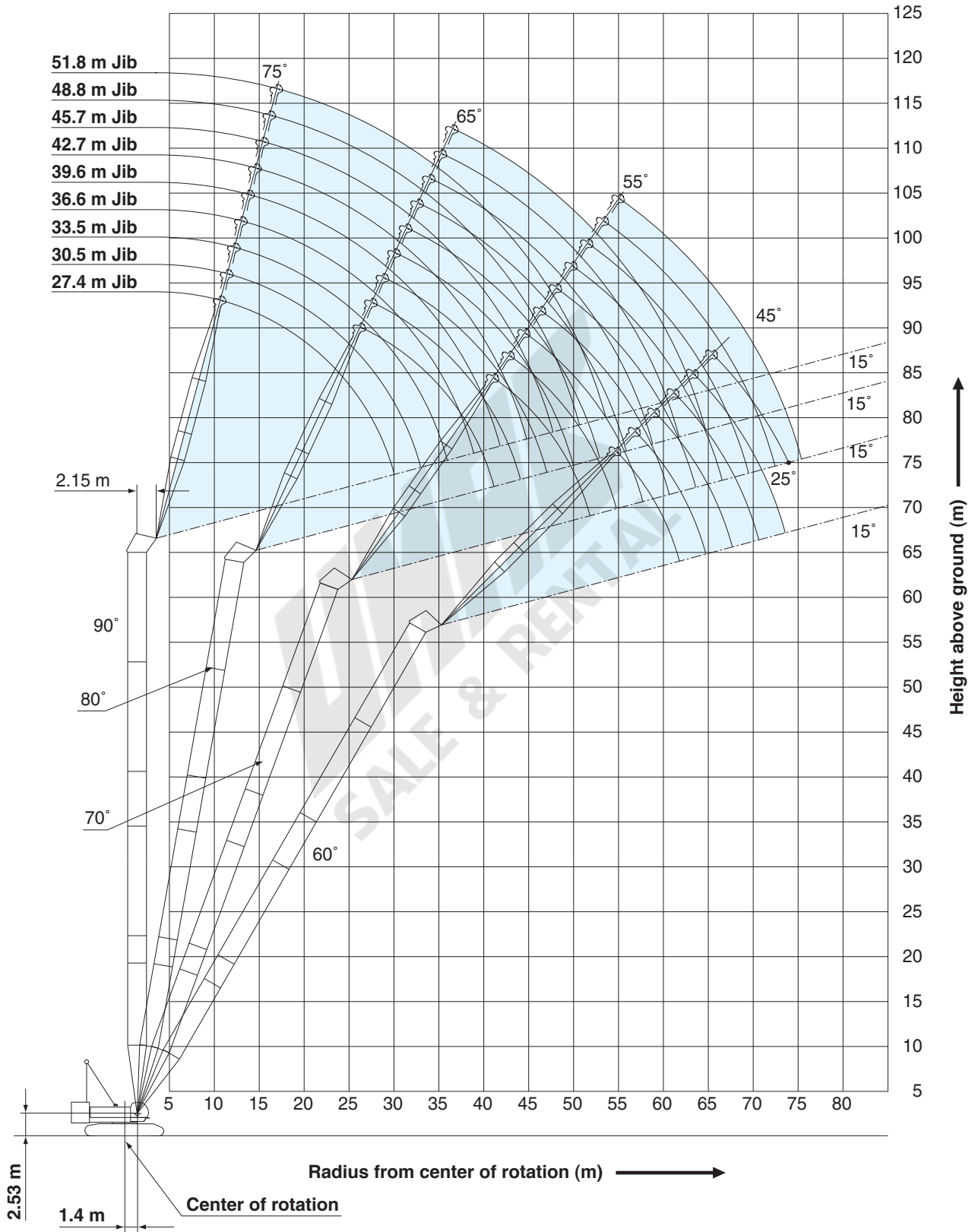

SUPPLEMENTAL DATA

- Ratings according to Japanese Construction Codes for Mobile Cranes.
- Operating radius is the horizontal distance from centerline of rotation to a vertical line through the center of gravity of the load.
- Deduct weight of hook block (s), slings and all other load handling accessories from main boom ratings shown.
- Ratings shown are based on freely suspended loads and make no allowance for such factors as wind effect on lifted load, ground conditions, out-of-level, operating speeds or any other condition that could be detrimental to the safe operation of this equipment. The operator, therefore, has the responsibility to judge the existing conditions and reduce lifted loads and operating speeds accordingly.
- Ratings are for operation on a firm and level surface, up to 1% gradient.
- At radii and boom lengths where no ratings are shown on chart, operation is not intended nor approved.
- Boom inserts and guy lines must be arranged as shown in the "Operator's Manual".
- Boom hoist reeving is 16 part line.
- Gantry must be in raised position for all conditions.
- Boom backstops are required for all boom lengths.
- The boom should be erected over the front of the crawlers, not laterally.
- Ratings inside of boxes are limited by strength of materials.
- The minimum rated load is 2.4 (ton).
- When erecting and lowering the boom length of 76.2 m with fixed jib, the blocks for erection must be placed at the end of the crawlers.

(Crane boom/long boom lifting)

- The total load that can be lifted is the value for weight of hook block, slings, and all other load handling accessories deducted from main boom ratings shown.

<Reference Information>

Main hoist loads

No. of Parts of Line	1	2	3	4	5
Maximum Loads (kN)	132	265	397	530	662
Maximum Loads (t)	13.5	27.0	40.5	54.0	67.5

No. of Parts of Line	6	7	8	9	10
Maximum Loads (kN)	794	927	1,059	1,192	1,324
Maximum Loads (t)	81.0	94.5	108.0	121.5	135.0

No. of Parts of Line	11	12	14	16	18
Maximum Loads (kN)	1,456	1,530	1,785	1,961	2,206
Maximum Loads (t)	148.5	156.0	182.0	200.0	225.0

No. of Parts of Line	22
Maximum Loads (kN)	2,452
Maximum Loads (t)	250.0

Auxiliary hoist loads

No. of Parts of Line	1	2
Maximum Loads (kN)	132	265
Maximum Loads (t)	13.5	27.0

Weight of hook block					
Hook Block	250 t	150 t	70 t	35 t	Ball Hook
Weight (t)	4.2	2.3	1.2	0.9	0.45

(Fixed jib lifting)

- The total load that can be lifted is the value for weight of jib hook block, slings, and all other load handling accessories deducted from fixed jib ratings shown.
- The availability of fixed jib mounting
 - on crane boom : range 42.7 m to 76.2 m.
- One part of line on hook is not allowed to use for 12.2 m jib length with offset angle 10 degrees.

Operation of this equipment in excess of rated loads or disregard of instruction voids the warranty.
--

LIFTING CAPACITIES



Crane Boom Lifting Capacities

Counterweight: 97.1 t
Carbody Weight: 23.1 t

Unit: metric ton

Working radius (m)	Boom length (m)												Working radius (m)	
	15.2	18.3	21.3	24.4	27.4	30.5	33.5	36.6	39.6	42.7	45.7	48.8		
4.6	4.6m/250.0													4.6
5.0	230.7	5.0m/219.0	5.5m/197.6											5.0
6.0	191.5	191.5	191.1	6.1m/175.6	6.6m/156.0									6.0
7.0	165.9	165.6	165.2	165.0	154.4	7.1m/141.7	7.7m/128.5							7.0
8.0	146.1	145.8	145.4	145.2	144.9	137.3	127.0	8.2m/117.3	8.7m/107.1					8.0
9.0	130.4	130.1	129.8	129.6	129.2	129.0	122.9	114.4	106.2	9.2m/98.6	9.8m/90.4			9.0
10.0	117.7	117.4	117.1	116.9	116.5	116.3	116.0	111.2	103.3	96.6	89.9	10.3m/81.0		10.0
12.0	90.5	90.3	90.1	90.0	89.8	89.8	89.5	89.5	89.4	89.2	85.1	79.8		12.0
14.0	69.0	72.7	72.4	72.3	72.1	72.0	71.8	71.8	71.6	71.4	71.2	71.2		14.0
16.0	14.8m/60.9	60.6	60.3	60.2	60.0	59.9	59.6	59.6	59.4	59.2	59.0	59.0		16.0
18.0		17.5m/52.2	51.6	51.4	51.2	51.1	50.8	50.8	50.5	50.3	50.1	50.1		18.0
20.0			45.0	44.8	44.5	44.4	44.0	44.0	43.8	43.6	43.4	43.3		20.0
22.0			20.1m/44.8	39.6	39.3	39.1	38.8	38.8	38.5	38.3	38.1	38.0		22.0
24.0				22.7m/38.0	35.1	34.9	34.5	34.5	34.2	34.0	33.8	33.7		24.0
26.0					25.4m/32.6	31.4	31.0	31.0	30.7	30.5	30.3	30.2		26.0
28.0						28.0m/28.5	28.1	28.1	27.8	27.5	27.3	27.3		28.0
30.0							25.7	25.7	25.3	25.1	24.8	24.8		30.0
32.0								30.7m/25.0	23.5	23.2	22.9	22.7		32.0
34.0									33.3m/22.3	21.4	21.1	20.8		34.0
36.0										35.9m/19.8	19.5	19.2		36.0
38.0											18.1	17.8		38.0
40.0											38.6m/17.7	16.5		40.0
42.0												41.2m/15.8		42.0
44.0													43.9m/14.3	44.0
Reeves	22	18	16	14	12	11	10	9	8	8	7	6		Reeves

Working radius (m)	Boom length (m)												Working radius (m)
	51.8	54.9	57.9	61.0	64.0	67.1	70.1	73.2	76.2				
10.0	10.8m/77.0	11.4m/71.4	11.9m/65.8										10.0
12.0	75.0	70.4	65.6	12.4m/61.1	12.9m/56.3	13.5m/51.6							12.0
14.0	70.8	66.5	61.9	58.3	54.7	50.8	14.0m/47.6	14.5m/43.1	15.1m/37.1				14.0
16.0	58.7	58.5	58.4	55.2	51.6	48.0	44.9	41.4	35.9				16.0
18.0	49.8	49.6	49.5	49.3	48.7	45.3	42.3	38.9	33.8				18.0
20.0	43.1	42.8	42.7	42.6	42.3	42.2	39.8	36.7	31.8				20.0
22.0	37.7	37.5	37.4	37.2	37.0	36.9	36.6	34.5	29.8				22.0
24.0	33.5	33.2	33.1	32.9	32.6	32.6	32.3	32.1	27.9				24.0
26.0	29.9	29.7	29.5	29.4	29.1	29.0	28.8	28.6	26.2				26.0
28.0	27.0	26.7	26.6	26.4	26.1	26.0	25.8	25.6	24.5				28.0
30.0	24.5	24.2	24.0	23.9	23.6	23.5	23.2	23.1	23.0				30.0
32.0	22.3	22.1	21.9	21.7	21.4	21.3	21.1	20.9	20.8				32.0
34.0	20.4	20.2	20.0	19.8	19.6	19.5	19.2	19.0	18.9				34.0
36.0	18.8	18.5	18.4	18.2	17.9	17.8	17.5	17.3	17.2				36.0
38.0	17.4	17.1	16.9	16.7	16.4	16.3	16.0	15.9	15.8				38.0
40.0	16.1	15.8	15.6	15.4	15.1	15.0	14.7	14.6	14.5				40.0
42.0	14.9	14.7	14.5	14.3	14.0	13.9	13.6	13.4	13.3				42.0
44.0	13.9	13.7	13.4	13.3	12.9	12.8	12.5	12.4	12.2				44.0
46.0	13.0	12.7	12.5	12.3	12.0	11.9	11.6	11.4	11.3				46.0
48.0	46.5m/12.8	11.9	11.6	11.5	11.2	11.0	10.7	10.6	10.4				48.0
50.0		49.1m/11.5	10.9	10.7	10.4	10.2	9.9	9.8	9.6				50.0
52.0			51.8m/10.3	10.0	9.7	9.5	9.2	9.0	8.9				52.0
54.0				9.4	9.0	8.9	8.6	8.4	8.2				54.0
56.0				54.4m/9.2	8.4	8.3	8.0	7.8	7.6				56.0
58.0					57.1m/8.2	7.7	7.4	7.2	6.9				58.0
60.0						59.7m/7.3	6.8	6.6	6.3				60.0
62.0							6.3	6.0	5.7				62.0
64.0							62.3m/6.2	5.5	5.2				64.0
66.0								65.0m/5.3	4.7				66.0
68.0									67.6m/4.3				68.0
Reeves	6	6	5	5	5	4	4	4	3				Reeves

Note:

Ratings according to Japanese Construction Codes for Mobile Cranes. Ratings shown in are determined by the strength of the boom or other structural components. Lifting capacities may vary depending on hook used or with/without auxiliary sheave. Please refer rated chart in operator's cabin.



Long Boom Lifting Capacities

Counterweight: 97.1 t
Carbody Weight: 23.1 t

Unit: metric ton

Working radius (m) \ Boom length (m)	73.2	76.2	79.2	82.3	85.3	88.4	91.4	Boom length (m) \ Working radius (m)
14.0	14.4m/37.5	14.9m/34.5	15.4m/32.6					14.0
16.0	36.0	33.5	32.1	16.0m/31.2	16.5m/27.0	17.0m/25.4	17.6m/21.5	16.0
18.0	34.4	31.9	30.6	29.6	27.0	25.0	21.2	18.0
20.0	32.9	30.4	29.1	28.2	26.2	24.1	20.0	20.0
22.0	31.6	29.1	27.9	26.9	25.2	23.0	18.9	22.0
24.0	30.4	27.9	26.8	25.7	24.2	22.0	17.8	24.0
26.0	28.8	26.5	25.6	24.6	23.2	21.1	16.9	26.0
28.0	26.2	25.2	24.5	23.6	22.3	20.1	16.0	28.0
30.0	23.8	23.6	23.3	22.6	21.1	19.1	15.3	30.0
32.0	21.8	21.7	21.6	21.5	19.9	18.1	14.5	32.0
34.0	19.9	19.9	19.7	19.7	18.7	17.1	13.8	34.0
36.0	18.3	18.3	18.2	18.1	17.7	16.1	13.1	36.0
38.0	16.9	16.8	16.7	16.7	16.5	15.1	12.5	38.0
40.0	15.6	15.6	15.4	15.4	15.4	14.2	11.8	40.0
42.0	14.5	14.5	14.3	14.3	14.3	13.4	11.2	42.0
44.0	13.4	13.4	13.2	13.2	13.2	12.5	10.7	44.0
46.0	12.5	12.5	12.3	12.3	12.2	11.8	10.2	46.0
48.0	11.6	11.5	11.4	11.4	11.3	11.1	9.8	48.0
50.0	10.7	10.7	10.6	10.5	10.5	10.3	9.4	50.0
52.0	10.0	10.0	9.9	9.8	9.8	9.6	8.9	52.0
54.0	9.3	9.3	9.1	9.1	9.0	9.0	8.5	54.0
56.0	8.6	8.6	8.5	8.4	8.4	8.4	7.8	56.0
58.0	8.0	8.0	7.8	7.8	7.7	7.7	7.2	58.0
60.0	7.4	7.3	7.2	7.2	7.1	7.1	6.7	60.0
62.0	6.8	6.7	6.7	6.6	6.6	6.6	6.1	62.0
64.0	6.3	6.1	6.1	6.1	6.0	6.0	5.6	64.0
66.0	64.9m/6.1	5.6	5.6	5.6	5.6	5.6	5.1	66.0
68.0		67.5m/5.4	5.3	5.2	5.2	5.2	4.6	68.0
70.0			4.8	4.7	4.7	4.7	4.1	70.0
72.0			70.2m/4.8	4.3	4.3	4.3	3.6	72.0
74.0				72.8m/4.2	3.9	3.9	3.1	74.0
76.0					74.5m/3.7	3.5	76.0m/2.6	76.0
78.0						3.2		78.0
80.0						78.1m/3.2		80.0
Reeves	3	3	3	3	2	2	2	Reeves

Note:

Ratings according to Japanese Construction Codes for Mobile Cranes.

Ratings shown in are determined by the strength of the boom or other structural components.

Lifting capacities may vary depending on hook used or with/without auxiliary sheave.

Please refer rated chart in operator's cabin.

LIFTING CAPACITIES



Fixed Jib Lifting Capacities (Without Main Hook) (Jib Offset Angle : 10°)

Counterweight: 97.1 t
Carbody Weight: 23.1 t
Unit: metric ton

Boom length (m)		42.7				45.7				48.8				Boom length (m)	
Jib length (m)		12.2	18.3	24.4	30.5	12.2	18.3	24.4	30.5	12.2	18.3	24.4	30.5	Jib length (m)	
Working radius (m)	12.0	12.9m/22.7				13.4m/22.7				13.9m/22.7				12.0	
	14.0	22.4	15.3m/15.3			22.6	15.8m/15.2			22.7				14.0	
	16.0	22.0	15.1	17.1m/8.6		22.1	15.2	17.6m/8.5		22.2	16.3m/15.2			16.0	
	18.0	21.6	14.8	8.5	18.5m/5.1	21.7	14.9	8.5	19.0m/5.1	21.8	15.0	18.1m/8.5	19.6m/5.1	18.0	
	20.0	21.1	14.6	8.3	5.0	21.3	14.6	8.4	5.0	21.4	14.7	8.4	5.0	20.0	
	22.0	20.8	14.3	8.2	4.9	20.9	14.4	8.3	4.9	21.1	14.5	8.3	4.9	22.0	
	24.0	20.4	14.0	8.1	4.8	20.6	14.1	8.1	4.8	20.7	14.2	8.2	4.8	24.0	
	26.0	20.1	13.8	7.8	4.6	20.3	13.9	7.9	4.6	20.4	14.0	8.0	4.7	26.0	
	28.0	19.8	13.5	7.5	4.4	20.0	13.6	7.6	4.5	20.1	13.7	7.8	4.5	28.0	
	30.0	19.5	13.3	7.3	4.2	19.7	13.4	7.4	4.3	19.9	13.5	7.5	4.4	30.0	
	32.0	19.3	13.1	7.1	4.0	19.3	13.2	7.2	4.1	19.6	13.3	7.3	4.2	32.0	
	34.0	18.8	12.9	6.8	3.9	18.6	13.0	7.0	4.0	19.1	13.1	7.1	4.0	34.0	
	36.0	18.1	12.5	6.6	3.8	17.8	12.8	6.8	3.8	18.5	12.9	6.9	3.9	36.0	
	38.0	17.4	11.9	6.5	3.6	17.1	12.4	6.6	3.7	17.8	12.8	6.7	3.8	38.0	
	40.0	16.8	11.4	6.3	3.5	16.3	11.8	6.4	3.6	16.7	12.3	6.5	3.7	40.0	
	42.0	15.8	10.9	6.1	3.4	15.5	11.3	6.3	3.5	15.5	11.7	6.4	3.5	42.0	
	44.0	14.8	10.4	6.0	3.3	14.6	10.8	6.1	3.4	14.4	11.2	6.2	3.4	44.0	
	46.0	14.0	10.0	5.9	3.2	13.6	10.4	6.0	3.3	13.4	10.8	6.1	3.3	46.0	
	48.0	13.1	9.6	5.7	3.1	12.7	10.0	5.8	3.2	12.5	10.4	6.0	3.2	48.0	
	50.0	12.2	9.3	5.6	3.0	11.9	9.7	5.7	3.1	11.7	10.0	5.8	3.2	50.0	
	52.0	50.3m/12.1	9.0	5.5	2.9	11.2	9.3	5.6	3.0	11.0	9.7	5.7	3.1	52.0	
	54.0		8.7	5.4	2.9	52.9m/10.9	9.0	5.5	2.9	10.3	9.4	5.6	3.0	54.0	
	56.0		8.5	5.3	2.8		8.8	5.4	2.9	55.5m/9.8	9.1	5.5	2.9	56.0	
	58.0		56.1m/8.4	5.3	2.7		8.5	5.3	2.8		8.8	5.4	2.9	58.0	
	60.0			5.2	2.7		58.7m/8.4	5.3	2.7		8.6	5.3	2.8	60.0	
	62.0			61.7m/5.1	2.6			5.2	2.7		61.4m/8.4	5.3	2.7	62.0	
	64.0				2.6			5.2	2.6			5.2	2.7	64.0	
	66.0				2.5			64.4m/5.1	2.6			5.2	2.6	66.0	
68.0				67.2m/2.5				2.5			67.0m/5.1	2.6	68.0		
70.0								69.8m/2.5				2.6	70.0		
72.0												2.5	72.0		
74.0												72.5m/2.5	74.0		
Reeves		2	2	1	1	2	2	1	1	2	2	1	1	Reeves	

Boom length (m)		51.8				54.9				57.9				Boom length (m)	
Jib length (m)		12.2	18.3	24.4	30.5	12.2	18.3	24.4	30.5	12.2	18.3	24.4	30.5	Jib length (m)	
Working radius (m)	14.0	14.4m/22.7				15.0m/22.7				15.5m/22.6				14.0	
	16.0	22.4	16.8m/15.2			22.5	17.4m/13.5			22.5	17.9m/13.5			16.0	
	18.0	22.0	15.1	18.7m/8.5		22.1	13.5	19.2m/8.5		22.2	13.5	19.7m/8.5		18.0	
	20.0	21.6	14.8	8.4	20.0m/5.1	21.7	13.5	8.5	20.6m/5.0	21.8	13.5	8.5	21.1m/5.0	20.0	
	22.0	21.2	14.5	8.3	5.0	21.4	13.5	8.3	5.0	21.5	13.5	8.4	5.0	22.0	
	24.0	20.9	14.3	8.2	4.9	21.0	13.5	8.2	4.9	21.2	13.5	8.3	4.9	24.0	
	26.0	20.6	14.1	8.1	4.8	20.7	13.5	8.1	4.8	20.9	13.5	8.2	4.8	26.0	
	28.0	20.3	13.8	7.9	4.6	20.4	13.5	8.0	4.7	20.6	13.5	8.1	4.7	28.0	
	30.0	20.0	13.6	7.6	4.4	20.2	13.5	7.7	4.5	20.3	13.5	7.8	4.5	30.0	
	32.0	19.8	13.4	7.4	4.3	19.9	13.5	7.5	4.3	20.0	13.5	7.6	4.4	32.0	
	34.0	19.5	13.2	7.2	4.1	19.7	13.3	7.3	4.2	19.8	13.4	7.4	4.2	34.0	
	36.0	19.2	13.0	7.0	4.0	18.9	13.1	7.1	4.0	18.6	13.2	7.2	4.1	36.0	
	38.0	17.7	12.9	6.8	3.8	17.4	13.0	6.9	3.9	17.1	13.1	7.0	4.0	38.0	
	40.0	16.4	12.7	6.6	3.7	16.1	12.8	6.7	3.8	15.8	12.9	6.8	3.9	40.0	
	42.0	15.2	12.1	6.5	3.6	14.9	12.6	6.6	3.7	14.6	12.8	6.7	3.7	42.0	
	44.0	14.1	11.6	6.3	3.5	13.8	12.0	6.4	3.6	13.5	12.4	6.5	3.6	44.0	
	46.0	13.1	11.2	6.2	3.4	12.8	11.6	6.3	3.5	12.5	11.9	6.4	3.5	46.0	
	48.0	12.2	10.8	6.1	3.3	12.0	11.1	6.2	3.4	11.6	11.5	6.3	3.4	48.0	
	50.0	11.4	10.4	5.9	3.2	11.1	10.7	6.0	3.3	10.8	11.1	6.1	3.3	50.0	
	52.0	10.7	10.0	5.8	3.1	10.4	10.4	5.9	3.2	10.1	10.5	6.0	3.3	52.0	
	54.0	10.0	9.7	5.7	3.1	9.7	10.0	5.8	3.1	9.4	9.8	5.9	3.2	54.0	
	56.0	9.4	9.4	5.6	3.0	9.1	9.5	5.7	3.0	8.8	9.2	5.8	3.1	56.0	
	58.0	8.8	9.1	5.5	2.9	8.5	8.9	5.6	3.0	8.2	8.6	5.7	3.0	58.0	
	60.0	58.2m/8.7	8.6	5.4	2.9	8.0	8.3	5.5	2.9	7.6	8.0	5.6	3.0	60.0	
	62.0		8.1	5.4	2.8	60.8m/7.8	7.8	5.4	2.8	7.1	7.5	5.5	2.9	62.0	
	64.0		64.0m/7.7	5.3	2.7		7.4	5.4	2.8	63.5m/6.8	7.0	5.4	2.8	64.0	
	66.0			5.2	2.7		6.9	5.3	2.7		6.6	5.4	2.8	66.0	
	68.0			5.2	2.6		66.6m/6.8	5.2	2.7		6.2	5.3	2.7	68.0	
70.0			69.6m/5.1	2.6			5.2	2.6		69.3m/5.9	5.2	2.7	70.0		
72.0				2.6			5.1	2.6			5.2	2.6	72.0		
74.0				2.5			72.3m/5.1	2.6			5.1	2.6	74.0		
76.0				75.1m/2.5				2.5			74.9m/5.1	2.6	76.0		
78.0								77.7m/2.5				2.5	78.0		
80.0												2.5	80.0		
82.0												80.4m/2.5	82.0		
Reeves		2	2	1	1	2	1	1	1	2	1	1	1	Reeves	

Note:

Ratings according to Japanese Construction Codes for Mobile Cranes.

Ratings shown in are determined by the strength of the boom or other structural components.

12.2 m (40 ft) jib length with offset angle 10 degrees, one part of line on hook is not allowed to use.

Lifting capacities may vary depending on hook used or with/without auxiliary sheave.

Please refer rated chart in operator's cabin.



Fixed Jib Lifting Capacities (Without Main Hook)

(Jib Offset Angle : 10°)

Counterweight: 97.1 t
Carbody Weight: 23.1 t

Unit: metric ton

Boom length (m)	61.0			64.0			67.1			70.1			Boom length (m)
Jib length (m)	18.3	24.4	30.5	18.3	24.4	30.5	18.3	24.4	30.5	18.3	24.4	30.5	Jib length (m)
18.0	18.4m/13.5			18.9m/13.5			19.4m/13.5						18.0
20.0	13.5	20.3m/8.5	21.7m/5.0	13.5	20.8m/8.5		13.5	21.4m/8.5		20.0m/13.5	21.8m/8.5		20.0
22.0	13.5	8.4	5.0	13.5	8.4	22.2m/5.0	13.5	8.5	22.7m/5.0	13.5	8.5	23.3m/5.0	22.0
24.0	13.5	8.3	4.9	13.5	8.3		13.5	8.3	5.0	13.5	8.4	5.0	24.0
26.0	13.5	8.2	4.8	13.5	8.2	4.9	13.5	8.2	4.9	13.5	8.3	4.9	26.0
28.0	13.5	8.1	4.8	13.5	8.1	4.8	13.5	8.1	4.8	13.5	8.2	4.8	28.0
30.0	13.5	7.9	4.6	13.5	8.0	4.7	13.5	8.1	4.7	13.5	8.1	4.7	30.0
32.0	13.5	7.7	4.4	13.5	7.8	4.5	13.5	7.9	4.6	13.5	8.0	4.6	32.0
34.0	13.5	7.5	4.3	13.5	7.6	4.4	13.5	7.7	4.4	13.5	7.8	4.5	34.0
36.0	13.3	7.3	4.2	13.4	7.4	4.2	13.5	7.5	4.3	13.5	7.6	4.3	36.0
38.0	13.2	7.1	4.0	13.3	7.2	4.1	13.3	7.3	4.2	13.4	7.4	4.2	38.0
40.0	13.0	6.9	3.9	13.1	7.0	4.0	13.2	7.1	4.0	13.3	7.2	4.1	40.0
42.0	12.9	6.8	3.8	12.9	6.9	3.9	13.0	7.0	3.9	13.1	7.1	4.0	42.0
44.0	12.7	6.6	3.7	12.8	6.7	3.8	12.9	6.8	3.8	12.9	6.9	3.9	44.0
46.0	12.3	6.5	3.6	12.5	6.6	3.6	12.2	6.7	3.7	11.9	6.8	3.8	46.0
48.0	11.8	6.4	3.5	11.6	6.4	3.6	11.3	6.5	3.6	11.0	6.6	3.7	48.0
50.0	11.1	6.2	3.4	10.7	6.3	3.5	10.5	6.4	3.5	10.2	6.5	3.6	50.0
52.0	10.3	6.1	3.3	10.0	6.2	3.4	9.7	6.3	3.4	9.4	6.4	3.5	52.0
54.0	9.6	6.0	3.2	9.3	6.1	3.3	9.0	6.2	3.3	8.7	6.2	3.4	54.0
56.0	9.0	5.9	3.2	8.7	6.0	3.2	8.4	6.1	3.3	8.1	6.1	3.3	56.0
58.0	8.4	5.8	3.1	8.1	5.9	3.1	7.8	6.0	3.2	7.5	6.0	3.2	58.0
60.0	7.8	5.7	3.0	7.5	5.8	3.1	7.2	5.9	3.1	6.9	5.9	3.2	60.0
62.0	7.3	5.6	3.0	7.0	5.7	3.0	6.7	5.8	3.1	6.4	5.8	3.1	62.0
64.0	6.8	5.5	2.9	6.5	5.6	2.9	6.2	5.7	3.0	5.9	5.7	3.0	64.0
66.0	6.4	5.4	2.8	6.1	5.5	2.9	5.8	5.6	2.9	5.5	5.7	3.0	66.0
68.0	6.0	5.4	2.8	5.7	5.4	2.8	5.4	5.5	2.9	5.1	5.6	2.9	68.0
70.0	5.6	5.3	2.7	5.3	5.4	2.8	5.0	5.4	2.8	4.7	5.2	2.9	70.0
72.0	71.9m/5.2	5.2	2.7	4.9	5.3	2.7	4.6	5.1	2.8	4.3	4.8	2.8	72.0
74.0		5.2	2.6	4.6	5.0	2.7	4.3	4.7	2.7	3.9	4.4	2.8	74.0
76.0		5.0	2.6	74.5m/4.5	4.7	2.6	3.9	4.4	2.7	3.6	4.1	2.7	76.0
78.0		77.6m/4.7	2.6		4.3	2.6	77.2m/3.8	4.1	2.6	3.3	3.8	2.7	78.0
80.0			2.5		4.0	2.6		3.8	2.6	79.9m/3.0	3.5	2.6	80.0
82.0			2.5		80.2m/4.0	2.5		3.5	2.6		3.2	2.6	82.0
84.0			83.0m/2.5			2.5		82.8m/3.3	2.5		2.9	2.6	84.0
86.0						85.7m/2.5			2.5		85.5m/2.7	2.5	86.0
88.0									2.5			2.5	88.0
90.0									88.3m/2.5			2.4	90.0
Reeves	1	1	1	1	1	1	1	1	1	1	1	1	Reeves

Boom length (m)	73.2			76.2			Boom length (m)
Jib length (m)	18.3	24.4	30.5	18.3	24.4	30.5	Jib length (m)
20.0	20.5m/13.5			21.1m/13.5			20.0
22.0	13.5	22.3m/8.5	23.8m/5.0	13.5	22.9m/8.5		22.0
24.0	13.5	8.4	5.0	13.5	8.4	24.4m/5.0	24.0
26.0	13.5	8.3	4.9	13.5	8.3	4.9	26.0
28.0	13.5	8.2	4.8	13.5	8.2	4.8	28.0
30.0	13.5	8.1	4.8	13.5	8.1	4.8	30.0
32.0	13.5	8.0	4.7	13.5	8.0	4.7	32.0
34.0	13.5	7.8	4.5	13.5	7.9	4.6	34.0
36.0	13.5	7.6	4.4	13.5	7.7	4.4	36.0
38.0	13.5	7.5	4.3	13.5	7.5	4.3	38.0
40.0	13.3	7.3	4.1	13.4	7.4	4.2	40.0
42.0	13.2	7.1	4.0	13.3	7.2	4.1	42.0
44.0	12.7	7.0	3.9	12.4	7.1	4.0	44.0
46.0	11.7	6.8	3.8	11.4	6.9	3.9	46.0
48.0	10.8	6.7	3.7	10.5	6.8	3.8	48.0
50.0	10.0	6.6	3.6	9.7	6.7	3.7	50.0
52.0	9.2	6.4	3.5	8.9	6.5	3.6	52.0
54.0	8.5	6.3	3.5	8.2	6.4	3.5	54.0
56.0	7.9	6.2	3.4	7.6	6.3	3.4	56.0
58.0	7.3	6.1	3.3	7.0	6.2	3.3	58.0
60.0	6.7	6.0	3.2	6.4	6.1	3.3	60.0
62.0	6.2	5.9	3.2	5.9	6.0	3.2	62.0
64.0	5.7	5.8	3.1	5.4	5.9	3.1	64.0
66.0	5.3	5.7	3.0	5.0	5.5	3.1	66.0
68.0	4.9	5.4	3.0	4.5	5.1	3.0	68.0
70.0	4.5	5.0	2.9	4.1	4.7	3.0	70.0
72.0	4.1	4.6	2.9	3.8	4.3	2.9	72.0
74.0	3.7	4.3	2.8	3.4	4.0	2.9	74.0
76.0	3.4	3.9	2.8	3.1	3.6	2.8	76.0
78.0	3.1	3.6	2.7	2.8	3.3	2.8	78.0
80.0	2.8	3.3	2.7	2.5	3.0	2.7	80.0
82.0	2.5	3.0	2.6		2.7	2.7	82.0
84.0		2.7	2.6		2.4	2.6	84.0
86.0		2.5	2.6			2.5	86.0
88.0			2.4				88.0
Reeves	1	1	1	1	1	1	Reeves

Note:

Ratings according to Japanese Construction Codes for Mobile Cranes. Ratings shown in are determined by the strength of the boom or other structural components. 12.2 m (40 ft) jib length with offset angle 10 degrees, one part of line on hook is not allowed to use.

Lifting capacities may vary depending on hook used or with/without auxiliary sheave. Please refer rated chart in operator's cabin.

LIFTING CAPACITIES



Fixed Jib Lifting Capacities (Without Main Hook) (Jib Offset Angle : 30°)

Counterweight: 97.1 t
Carbody Weight: 23.1 t
Unit: metric ton

Boom length (m)		42.7				45.7				48.8				Boom length (m)
Jib length (m)		12.2	18.3	24.4	30.5	12.2	18.3	24.4	30.5	12.2	18.3	24.4	30.5	Jib length (m)
Working radius (m)	16.0	16.5m/18.4				17.0m/18.4				17.6m/18.4				16.0
	18.0	17.7				18.0				18.2				18.0
	20.0	16.8	20.7m/12.1			17.1	21.2m/12.1			17.3	21.7m/12.1			20.0
	22.0	16.0	11.8			16.3	12.0			16.6	12.1			22.0
	24.0	15.3	11.3	24.4m/6.3		15.6	11.4	24.9m/6.3		15.9	11.6	25.4m/6.3		24.0
	26.0	14.7	10.7	6.2	27.7m/3.3	15.0	10.9	6.2		15.2	11.1	6.2		26.0
	28.0	14.1	10.3	6.0	3.3	14.4	10.5	6.1	28.2m/3.3	14.7	10.6	6.1	28.8m/3.3	28.0
	30.0	13.6	9.9	5.9	3.2	13.9	10.1	5.9	3.2	14.1	10.2	6.0	3.2	30.0
	32.0	13.1	9.5	5.7	3.1	13.4	9.7	5.8	3.1	13.7	9.9	5.8	3.2	32.0
	34.0	12.7	9.2	5.6	3.0	13.0	9.3	5.7	3.1	13.2	9.5	5.7	3.1	34.0
	36.0	12.3	8.8	5.5	3.0	12.6	9.0	5.6	3.0	12.9	9.2	5.6	3.0	36.0
	38.0	12.0	8.6	5.4	2.9	12.2	8.7	5.5	2.9	12.5	8.9	5.5	2.9	38.0
	40.0	11.7	8.3	5.3	2.8	11.9	8.5	5.4	2.8	12.2	8.7	5.4	2.9	40.0
	42.0	11.4	8.1	5.2	2.8	11.7	8.3	5.3	2.8	11.9	8.4	5.4	2.8	42.0
	44.0	11.2	7.9	5.2	2.7	11.4	8.0	5.2	2.7	11.6	8.2	5.3	2.8	44.0
	46.0	11.0	7.7	5.1	2.6	11.2	7.8	5.2	2.7	11.4	8.0	5.2	2.7	46.0
	48.0	10.9	7.5	5.0	2.6	11.0	7.7	5.1	2.6	11.2	7.8	5.1	2.7	48.0
	50.0	10.8	7.4	5.0	2.6	10.9	7.5	5.0	2.6	11.0	7.7	5.1	2.6	50.0
	52.0	51.0m/10.8	7.3	4.9	2.5	10.8	7.4	5.0	2.5	10.9	7.5	5.0	2.6	52.0
	54.0		7.2	4.9	2.5	53.7m/10.8	7.3	4.9	2.5	10.4	7.4	5.0	2.5	54.0
	56.0		7.1	4.8	2.4		7.2	4.9	2.5	9.8	7.3	4.9	2.5	56.0
	58.0		57.1m/7.1	4.8	2.4		7.1	4.8	2.4	56.3m/9.7	7.2	4.9	2.5	58.0
	60.0			4.7	2.4		59.8m/7.1	4.8	2.4		7.1	4.8	2.4	60.0
	62.0			4.7	2.4			4.7	2.4		7.1	4.8	2.4	62.0
	64.0			63.2m/4.7	2.4			4.7	2.4		62.4m/7.1	4.7	2.4	64.0
	66.0				2.4			65.9m/4.7	2.4			4.7	2.4	66.0
	68.0				2.4				2.4			4.6	2.4	68.0
	70.0				69.3m/2.4				2.4			68.5m/4.6	2.4	70.0
72.0								72.0m/2.4				2.4	72.0	
74.0												2.4	74.0	
76.0												74.6m/2.4	76.0	
Reeves		2	1	1	1	2	1	1	1	2	1	1	1	Reeves

Boom length (m)		51.8				54.9				57.9				Boom length (m)
Jib length (m)		12.2	18.3	24.4	30.5	12.2	18.3	24.4	30.5	12.2	18.3	24.4	30.5	Jib length (m)
Working radius (m)	18.0	18.1m/18.4				18.7m/18.4				19.2m/18.3				18.0
	20.0	17.6				17.8				18.0				20.0
	22.0	16.8	22.2m/12.1			17.1	22.8m/12.1			17.3	23.3m/12.1			22.0
	24.0	16.1	11.8			16.4	11.9			16.6	12.0			24.0
	26.0	15.5	11.3	26.0m/6.3		15.7	11.4	26.5m/6.2		16.0	11.5	27.1m/6.2		26.0
	28.0	14.9	10.8	6.1	29.3m/3.3	15.2	11.0	6.2	29.9m/3.3	15.4	11.1	6.2		28.0
	30.0	14.4	10.4	6.0	3.3	14.7	10.6	6.0	3.3	14.9	10.7	6.1	30.3m/3.3	30.0
	32.0	13.9	10.0	5.9	3.2	14.2	10.2	5.9	3.2	14.4	10.3	6.0	3.2	32.0
	34.0	13.5	9.7	5.8	3.1	13.8	9.9	5.8	3.1	14.0	10.0	5.8	3.1	34.0
	36.0	13.1	9.4	5.7	3.0	13.4	9.5	5.7	3.0	13.6	9.7	5.7	3.1	36.0
	38.0	12.8	9.1	5.6	3.0	13.0	9.3	5.6	3.0	13.2	9.4	5.7	3.0	38.0
	40.0	12.4	8.8	5.5	2.9	12.7	9.0	5.5	2.9	12.9	9.1	5.6	2.9	40.0
	42.0	12.1	8.6	5.4	2.8	12.4	8.7	5.5	2.9	12.6	8.9	5.5	2.9	42.0
	44.0	11.9	8.4	5.3	2.8	12.1	8.5	5.4	2.8	12.3	8.7	5.4	2.8	44.0
	46.0	11.6	8.2	5.3	2.7	11.8	8.3	5.3	2.7	12.0	8.5	5.3	2.8	46.0
	48.0	11.4	8.0	5.2	2.7	11.6	8.1	5.2	2.7	11.8	8.3	5.3	2.7	48.0
	50.0	11.2	7.8	5.1	2.6	11.4	7.9	5.2	2.7	11.1	8.1	5.2	2.7	50.0
	52.0	10.9	7.6	5.1	2.6	10.6	7.8	5.1	2.6	10.3	7.9	5.2	2.6	52.0
	54.0	10.2	7.5	5.0	2.5	9.9	7.6	5.1	2.6	9.6	7.8	5.1	2.6	54.0
	56.0	9.5	7.4	5.0	2.5	9.2	7.5	5.0	2.5	9.0	7.6	5.1	2.6	56.0
	58.0	8.9	7.3	4.9	2.5	8.6	7.4	5.0	2.5	8.3	7.5	5.0	2.5	58.0
	60.0	59.0m/8.6	7.2	4.9	2.4	8.1	7.3	4.9	2.5	7.7	7.4	5.0	2.5	60.0
	62.0		7.1	4.8	2.4	61.6m/7.6	7.2	4.9	2.4	7.2	7.3	4.9	2.5	62.0
	64.0		7.1	4.8	2.4		7.1	4.8	2.4	6.7	7.2	4.9	2.4	64.0
	66.0		65.0m/7.1	4.7	2.4		7.1	4.8	2.4	64.2m/6.7	6.9	4.8	2.4	66.0
	68.0			4.7	2.4		67.7m/6.7	4.7	2.4		6.4	4.8	2.4	68.0
	70.0			4.6	2.4			4.7	2.4		6.0	4.7	2.4	70.0
	72.0			71.1m/4.6	2.4			4.6	2.4		70.3m/5.9	4.7	2.4	72.0
74.0				2.4			73.8m/4.6	2.4			4.6	2.4	74.0	
76.0				2.4				2.4			4.6	2.4	76.0	
78.0				77.2m/2.4				2.4			76.4m/4.6	2.4	78.0	
80.0								79.9m/2.4				2.4	80.0	
82.0												2.4	82.0	
84.0												82.5m/2.4	84.0	
Reeves		2	1	1	1	2	1	1	1	2	1	1	1	Reeves

Note:
Ratings according to Japanese Construction Codes for Mobile Cranes.
Ratings shown in are determined by the strength of the boom or other structural components.
Lifting capacities may vary depending on hook used or with/without auxiliary sheave.
Please refer rated chart in operator's cabin.



Fixed Jib Lifting Capacities (Without Main Hook) (Jib Offset Angle : 30°)

Counterweight: 97.1 t
Carbody Weight: 23.1 t
Unit: metric ton

Boom length (m)		61.0				64.0				67.1				Boom length (m)
Jib length (m)		12.2	18.3	24.4	30.5	12.2	18.3	24.4	30.5	12.2	18.3	24.4	30.5	Jib length (m)
Working radius (m)	18.0	19.8m/13.5												18.0
	20.0	13.5				20.3m/13.5				20.8m/13.5				20.0
	22.0	13.5	23.9m/12.1			13.5				13.5				22.0
	24.0	13.5	12.1			13.5	24.4m/12.0			13.5	24.9m/12.0			24.0
	26.0	13.5	11.7	27.6m/6.2		13.5	11.8			13.5	11.9			26.0
	28.0	13.5	11.3	6.2		13.5	11.4	28.1m/6.2		13.5	11.5	28.6m/6.2		28.0
	30.0	13.5	10.9	6.1	30.9m/3.3	13.5	11.0	6.1	31.4m/3.3	13.5	11.1	6.1		30.0
	32.0	13.5	10.5	6.0	3.2	13.5	10.6	6.0	3.2	13.5	10.8	6.0	32.0m/3.3	32.0
	34.0	13.5	10.2	5.9	3.2	13.5	10.3	5.9	3.2	13.5	10.4	5.9	3.2	34.0
	36.0	13.5	9.8	5.8	3.1	13.5	10.0	5.8	3.1	13.5	10.1	5.8	3.1	36.0
	38.0	13.4	9.6	5.7	3.0	13.5	9.7	5.7	3.0	13.5	9.8	5.8	3.0	38.0
	40.0	13.1	9.3	5.6	3.0	13.3	9.4	5.6	3.0	13.5	9.6	5.7	3.0	40.0
	42.0	12.8	9.0	5.5	2.9	13.0	9.2	5.6	2.9	13.2	9.3	5.6	2.9	42.0
	44.0	12.5	8.8	5.4	2.8	12.7	8.9	5.5	2.9	12.9	9.1	5.5	2.9	44.0
	46.0	12.2	8.6	5.4	2.8	12.4	8.7	5.4	2.8	12.2	8.9	5.4	2.8	46.0
	48.0	11.8	8.4	5.3	2.7	11.5	8.5	5.3	2.8	11.3	8.7	5.4	2.8	48.0
	50.0	11.0	8.2	5.3	2.7	10.7	8.3	5.3	2.7	10.4	8.5	5.3	2.7	50.0
	52.0	10.2	8.0	5.2	2.6	9.9	8.2	5.2	2.7	9.6	8.3	5.3	2.7	52.0
	54.0	9.5	7.9	5.1	2.6	9.2	8.0	5.2	2.6	8.9	8.1	5.2	2.6	54.0
	56.0	8.8	7.7	5.1	2.6	8.5	7.9	5.1	2.6	8.3	8.0	5.2	2.6	56.0
	58.0	8.2	7.6	5.0	2.5	7.9	7.7	5.1	2.6	7.6	7.8	5.1	2.6	58.0
	60.0	7.6	7.5	5.0	2.5	7.3	7.6	5.0	2.5	7.1	7.7	5.1	2.5	60.0
	62.0	7.1	7.4	5.0	2.5	6.8	7.5	5.0	2.5	6.5	7.3	5.0	2.5	62.0
	64.0	6.6	7.3	4.9	2.4	6.3	7.0	5.0	2.5	6.0	6.8	5.0	2.5	64.0
	66.0	6.1	6.8	4.9	2.4	5.8	6.5	4.9	2.4	5.6	6.3	5.0	2.4	66.0
	68.0	66.9m/5.9	6.3	4.9	2.4	5.4	6.0	4.9	2.4	5.1	5.8	4.9	2.4	68.0
	70.0		5.9	4.8	2.4	69.5m/5.1	5.6	4.9	2.4	4.7	5.4	4.9	2.4	70.0
	72.0		5.5	4.8	2.4		5.2	4.8	2.4	4.3	5.0	4.9	2.4	72.0
	74.0		73.0m/5.2	4.8	2.4		4.8	4.8	2.4	72.2m/4.3	4.6	4.9	2.4	74.0
	76.0			4.7	2.4		75.6m/4.5	4.7	2.4		4.2	4.7	2.4	76.0
78.0			4.7	2.4			4.6	2.4		3.9	4.3	2.4	78.0	
80.0			79.1m/4.6	2.4			4.2	2.4		78.3m/3.8	4.0		80.0	
82.0				2.4			81.8m/3.9	2.4			3.7		82.0	
84.0				2.4							3.4		84.0	
86.0				85.1m/2.4							84.3m/3.3		86.0	
Reeves	1	1	1	1	1	1	1	1	1	1	1	1	Reeves	

Boom length (m)		70.1				73.2				76.2				Boom length (m)
Jib length (m)		12.2	18.3	24.4	30.5	12.2	18.3	24.4	30.5	12.2	18.3	24.4	30.5	Jib length (m)
Working radius (m)	20.0	21.3m/13.5				21.9m/13.5								20.0
	22.0	13.5				13.5				22.3m/13.5				22.0
	24.0	13.5	25.4m/12.1			13.5				13.5				24.0
	26.0	13.5	12.0			13.5	26.0m/12.1			13.5	26.5m/12.0			26.0
	28.0	13.5	11.6	29.1m/6.2		13.5	11.7	29.7m/6.2		13.5	11.8			28.0
	30.0	13.5	11.2	6.2		13.5	11.4	6.2		13.5	11.5	30.2m/6.2		30.0
	32.0	13.5	10.9	6.1	32.5m/3.2	13.5	11.0	6.1	33.0m/3.2	13.5	11.1	6.1	33.5m/3.2	32.0
	34.0	13.5	10.6	6.0	3.2	13.5	10.7	6.0	3.2	13.5	10.8	6.0	3.2	34.0
	36.0	13.5	10.2	5.9	3.1	13.5	10.4	5.9	3.1	13.5	10.5	5.9	3.1	36.0
	38.0	13.5	10.0	5.8	3.1	13.5	10.1	5.8	3.1	13.5	10.2	5.8	3.1	38.0
	40.0	13.5	9.7	5.7	3.0	13.5	9.8	5.7	3.0	13.5	9.9	5.7	3.0	40.0
	42.0	13.4	9.4	5.6	2.9	13.5	9.6	5.6	3.0	13.5	9.7	5.7	3.0	42.0
	44.0	12.9	9.2	5.5	2.9	12.8	9.3	5.6	2.9	12.5	9.5	5.6	2.9	44.0
	46.0	11.9	9.0	5.5	2.8	11.7	9.1	5.5	2.9	11.5	9.2	5.5	2.9	46.0
	48.0	11.0	8.8	5.4	2.8	10.8	8.9	5.4	2.8	10.5	9.0	5.5	2.8	48.0
	50.0	10.1	8.6	5.3	2.7	10.0	8.7	5.4	2.8	9.7	8.8	5.4	2.8	50.0
	52.0	9.3	8.4	5.3	2.7	9.2	8.5	5.3	2.7	8.9	8.7	5.3	2.7	52.0
	54.0	8.6	8.3	5.2	2.7	8.5	8.4	5.3	2.7	8.2	8.5	5.3	2.7	54.0
	56.0	7.9	8.1	5.2	2.6	7.8	8.2	5.2	2.6	7.5	8.3	5.2	2.7	56.0
	58.0	7.3	8.0	5.1	2.6	7.2	8.0	5.2	2.6	6.9	7.7	5.2	2.6	58.0
	60.0	6.7	7.6	5.1	2.6	6.6	7.4	5.1	2.6	6.3	7.1	5.1	2.6	60.0
	62.0	6.2	7.0	5.1	2.5	6.1	6.9	5.1	2.5	5.8	6.6	5.1	2.5	62.0
	64.0	5.7	6.5	5.0	2.5	5.6	6.3	5.0	2.5	5.3	6.1	5.1	2.5	64.0
	66.0	5.3	6.0	5.0	2.5	5.1	5.8	5.0	2.5	4.8	5.6	5.0	2.5	66.0
	68.0	4.8	5.5	5.0	2.4	4.7	5.4	5.0	2.5	4.3	5.1	5.0	2.5	68.0
	70.0	4.4	5.1	4.9	2.4	4.2	5.0	5.0	2.4	3.9	4.7	5.0	2.4	70.0
	72.0	4.0	4.7	4.9	2.4	3.8	4.5	4.9	2.4	3.5	4.3	4.8	2.4	72.0
	74.0	3.7	4.3	4.8	2.4	3.4	4.2	4.7	2.4	3.2	3.9	4.4	2.4	74.0
	76.0	74.8m/3.5	3.9	4.4	2.4	3.1	3.8	4.3	2.4	2.8	3.5	4.0		76.0
	78.0		3.6	4.1	2.4	77.5m/2.9	3.4	3.9	2.4	2.5	3.2	3.7		78.0
80.0		3.3	3.7			3.1	3.6			2.8	3.3		80.0	
82.0		80.9m/3.1	3.4			2.8	3.3			2.5	3.0		82.0	
84.0			3.1			83.5m/2.5	3.0				2.7		84.0	
86.0			2.8				2.7				2.4		86.0	
88.0			87.0m/2.6				2.4						88.0	
Reeves	1	1	1	1	1	1	1	1	1	1	1	1	Reeves	

Note:
Ratings according to Japanese Construction Codes for Mobile Cranes.
Ratings shown in are determined by the strength of the boom or other structural components.
Lifting capacities may vary depending on hook used or with/without auxiliary sheave.
Please refer rated chart in operator's cabin.

SUPPLEMENTAL DATA

- Ratings according to Japanese Construction Codes for Mobile Cranes.
- Operating radius is the horizontal distance from centerline of rotation to a vertical line through the center of gravity of the load.
- Ratings shown are based on freely suspended loads and make no allowance for such factors as wind effect on lifted load, ground conditions, out-of-level, operating speeds or any other condition that could be detrimental to the safe operation of this equipment. The operator, therefore, has the responsibility to judge the existing conditions and reduce lifted loads and operating speeds accordingly.
- Ratings are for operation on a firm and level surface, up to 1% gradient.
- At radii and boom lengths where no ratings are shown on chart, operation is not intended nor approved.
- Tower and jib inserts and guy lines must be arranged as shown in the "Operator's Manual".
- Tower hoist reeving is 16 part line.
- Jib hoist reeving is 8 part line.
- Gantry must be in raised position for all conditions.
- Tower and jib backstops are required for all tower and jib combinations.
- Ratings inside of boxes are limited by strength of materials.
- The tower should be erected over the front of the crawlers, not laterally.
- When erecting and lowering the tower length of 64.1 m, the blocks for erection must be placed at the end of the crawlers.
- The minimum rated load is 2.4 (ton).
- The total load that can be lifted is the value for weight of hook block, slings, and all other load handling accessories deducted from tower jib ratings shown.

Tower and jib combinations

		Jib Length (m)								
		27.4	30.5	33.5	36.6	39.6	42.7	45.7	48.8	51.8
Tower Length (m)	36.6	○	○	×	×	×	×	×	×	×
	39.7	○	○	○	×	×	×	×	×	×
	42.7	○	○	○	○	×	×	×	×	×
	45.8	○	○	○	○	○	×	×	×	×
	48.8	○	○	○	○	○	○	×	×	×
	51.9	○	○	○	○	○	○	○	×	×
	54.9	○	○	○	○	○	○	○	○	×
	58.0	○	○	○	○	○	○	○	○	○
	61.0	○	○	○	○	○	○	○	○	○
	64.1	○	○	○	○	○	○	○	○	○

○ : Combinations which is allowed.

- Maximum hoist load for number of reeving parts of line for hoist rope.

For jib hook

No. of Parts of Line	1	2
Maximum Loads (kN)	132	245
Maximum Loads (t)	13.5	25.0

Weight of hook block		
Hook Block	35 t	Ball Hook
Weight (t)	0.9	0.45

Operation of this equipment in excess of rated loads or disregard of instruction voids the warranty.

LIFTING CAPACITIES



Tower Jib Lifting Capacities

Counterweight: 97.1 t

Carbody Weight: 23.1 t

Unit: metric ton

36.6 m Tower Length	Tower length (m)	36.6								Tower length (m)
	Jib length (m)	27.4				30.5				Jib length (m)
	Tower angle	90°	80°	70°	60°	90°	80°	70°	60°	Tower angle
Working radius (m)	10.0	10.9m/25.0				11.7m/25.0				10.0
	12.0	25.0				25.0				12.0
	14.0	25.0				25.0				14.0
	16.0	25.0				25.0				16.0
	18.0	25.0				24.2				18.0
	20.0	24.2	21.7m/23.4			23.5				20.0
	22.0	23.2	23.2			22.7	23.0m/21.9			22.0
	24.0	21.0	21.0			21.0	21.0			24.0
	26.0	18.6	18.6			18.6	18.6			26.0
	28.0	16.0	16.8			16.7	16.7			28.0
	30.0	29.9m/11.2	15.2	31.9m/14.1		15.1	15.1			30.0
	32.0		14.0	14.0		12.0	13.9	33.7m/13.0		32.0
	34.0		12.8	12.8		32.8m/10.6	12.7	12.7		34.0
	36.0		11.8	11.8			11.7	11.7		36.0
	38.0		36.2m/11.8	11.1			11.0	11.0		38.0
	40.0			10.4	41.2m/10.0		39.2m/10.6	10.3		40.0
	42.0			9.7	9.7			9.6	43.3m/9.2	42.0
	44.0			42.3m/9.6	9.1			9.0	9.0	44.0
	46.0				8.6			45.2m/8.7	8.5	46.0
	48.0				47.9m/8.2				8.1	48.0
50.0								7.7	50.0	
52.0								50.8m/7.6	52.0	
Reeves	2	2	2	2	2	2	2	2	Reeves	

39.7 m Tower Length	Tower length (m)	39.7											Tower length (m)	
	Jib length (m)	27.4				30.5				33.5			Jib length (m)	
	Tower angle	90°	80°	70°	60°	90°	80°	70°	60°	90°	80°	70°	60°	Tower angle
Working radius (m)	10.0	10.9m/25.0				11.7m/25.0								10.0
	12.0	25.0				25.0				12.5m/25.0				12.0
	14.0	25.0				25.0				25.0				14.0
	16.0	25.0				25.0				24.2				16.0
	18.0	25.0				24.2				23.4				18.0
	20.0	24.2				23.5				22.6				20.0
	22.0	23.2	22.3m/22.8			22.7	23.6m/21.4			21.8				22.0
	24.0	20.9	20.9			21.0	20.9			21.0	24.8m/20.2			24.0
	26.0	18.5	18.6			18.6	18.6			18.8	18.6			26.0
	28.0	16.1	16.8			16.7	16.7			16.7	16.7			28.0
	30.0	29.9m/11.2	15.2			15.1	15.1			15.3	15.1			30.0
	32.0		14.0	33.0m/13.4		12.0	13.9			14.0	13.9			32.0
	34.0		12.8	12.8		32.8m/10.6	12.7	34.7m/12.4		12.0	12.7			34.0
	36.0		11.8	11.8			11.7	11.7		35.8m/9.2	11.7	36.5m/11.5		36.0
	38.0		36.7m/11.5	11.1			11.0	11.0			11.0	11.0		38.0
	40.0			10.4			39.7m/10.4	10.3			10.2	10.3		40.0
	42.0			9.7	42.7m/9.5			9.6			9.6	9.6		42.0
	44.0			43.3m/9.3	9.1			9.0	44.9m/8.7		42.6m/9.4	9.0		44.0
	46.0				8.6			8.5	8.5			8.4	47.0m/8.2	46.0
	48.0				8.2			46.3m/8.4	8.1			8.0	8.0	48.0
50.0				49.4m/8.0				7.7			49.2m/7.7	7.6	50.0	
52.0								7.3				7.2	52.0	
54.0									52.4m/7.2			6.8	54.0	
56.0												55.3m/6.6	56.0	
Reeves	2	2	2	2	2	2	2	2	2	2	2	2	Reeves	

Note:

Ratings according to Japanese Legislation for Mobile Cranes.

Ratings shown in are determined by the strength of the boom or other structural components.

Lifting capacities may vary depending on hook used or with/without auxiliary sheave.

Please refer rated chart in operator's cabin.

LIFTING CAPACITIES



Tower Jib Lifting Capacities

Counterweight: 97.1 t

Carbody Weight: 23.1 t

Unit: metric ton

42.7 m Tower Length	Tower length (m)	42.7																Tower length (m)
	Jib length (m)	27.4				30.5				33.5				36.6				Jib length (m)
	Tower angle	90°	80°	70°	60°	90°	80°	70°	60°	90°	80°	70°	60°	90°	80°	70°	60°	Tower angle
Working radius (m)	10.0	10.9m/25.0				11.7m/25.0												10.0
	12.0	25.0				25.0				12.5m/25.0				13.3m/23.9				12.0
	14.0	25.0				25.0				25.0				23.6				14.0
	16.0	25.0				25.0				24.2				22.9				16.0
	18.0	25.0				24.2				23.4				22.2				18.0
	20.0	24.2				23.5				22.6				21.4				20.0
	22.0	23.2	22.8m/22.3			22.7				21.8				20.7				22.0
	24.0	20.9	20.9			21.0	24.1m/20.9			21.0	25.4m/19.6			19.9				24.0
	26.0	18.5	18.6			18.6	18.6			18.8	18.6			18.8	26.7m/18.2			26.0
	28.0	16.3	16.8			16.7	16.7			16.7	16.7			16.8	16.7			28.0
	30.0	29.9m/11.3	15.2			15.1	15.1			15.3	15.1			15.2	15.0			30.0
	32.0		14.0			12.0	13.9			14.0	13.9			14.0	13.8			32.0
	34.0		12.8	34.0m/12.8		32.8m/10.6	12.7	35.8m/11.8		12.1	12.7			12.8	12.6			34.0
	36.0		11.8	11.8			11.7	11.7		35.8m/9.2	11.7			11.7	11.6			36.0
	38.0		37.3m/11.4	11.1			11.0	11.0			11.0	38.0m/11.0		9.3	10.9	39.3m/10.4		38.0
	40.0			10.4			10.3	10.3			10.2	10.3		38.7m/8.7	10.1	10.1		40.0
	42.0			9.7			40.2m/10.2	9.6			9.6	9.6			9.5	9.5		42.0
	44.0			9.1	44.2m/9.0			9.0			43.2m/9.3	9.0			8.9	8.9		44.0
	46.0			44.4m/8.9	8.6			8.5	46.4m/8.4			8.4			8.4	8.3		46.0
	48.0				8.2			47.3m/8.2	8.1			7.9	48.5m/7.9		46.1m/8.3	7.8		48.0
50.0				7.8				7.7			7.5	7.6		7.4	50.7m/7.3		50.0	
52.0				51.0m/7.6				7.3			50.2m/7.5	7.2		7.0	7.1		52.0	
54.0								53.9m/6.9				6.8		53.2m/6.7	6.7		54.0	
56.0												6.4				6.3	56.0	
58.0												56.8m/6.3				6.0	58.0	
60.0																59.8m/5.7	60.0	
	Reeves	2	2	2	2	2	2	2	2	2	2	2	2	2	2	2	2	Reeves

Note:

Ratings according to Japanese Legislation for Mobile Cranes.

Ratings shown in are determined by the strength of the boom or other structural components.

Lifting capacities may vary depending on hook used or with/without auxiliary sheave.

Please refer rated chart in operator's cabin.

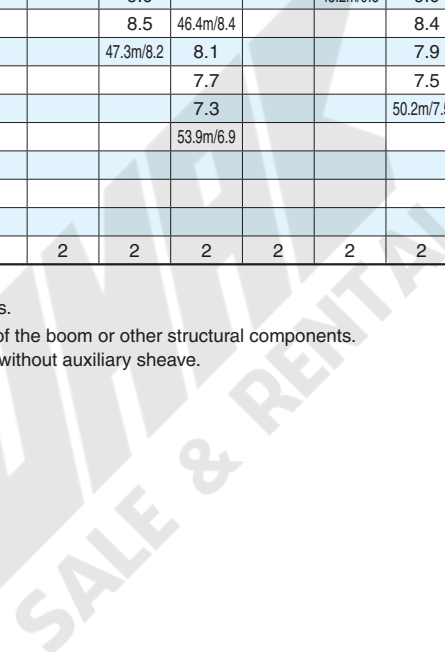



Tower Jib Lifting Capacities

Counterweight: 97.1 t
Carbody Weight: 23.1 t

Unit: metric ton

45.8 m Tower Length	Tower length (m)	45.8												Tower length (m)
	Jib length (m)	27.4				30.5				33.5				Jib length (m)
	Tower angle	90°	80°	70°	60°	90°	80°	70°	60°	90°	80°	70°	60°	Tower angle
Working radius (m)	10.0	10.9m/25.0				11.7m/25.0								10.0
	12.0	25.0				25.0				12.5m/25.0				12.0
	14.0	25.0				25.0				25.0				14.0
	16.0	25.0				25.0				24.2				16.0
	18.0	25.0				24.2				23.4				18.0
	20.0	24.2				23.5				22.6				20.0
	22.0	23.2	23.3m/21.7			22.7				21.8				22.0
	24.0	20.9	20.9			21.0	24.5m/20.3			21.0	25.9m/18.7			24.0
	26.0	18.5	18.6			18.6	18.6			18.8	18.6			26.0
	28.0	16.3	16.8			16.7	16.7			16.7	16.7			28.0
	30.0	29.9m/11.3	15.2			15.1	15.1			15.3	15.1			30.0
	32.0		14.0			12.0	13.9			14.0	13.9			32.0
	34.0		12.8	35.0m/12.3		32.8m/10.6	12.7			12.1	12.7			34.0
	36.0		11.8	11.8			11.7	36.8m/11.5		35.8m/9.2	11.7			36.0
	38.0		37.8m/11.2	11.1			11.0	11.0			11.0	38.5m/10.9		38.0
	40.0			10.4			10.3	10.3			10.2	10.3		40.0
	42.0			9.7			40.7m/10.1	9.6			9.6	9.6		42.0
	44.0			9.1	45.8m/8.6			9.0			43.7m/9.1	9.0		44.0
	46.0			45.4m/8.8	8.6			8.5	47.9m/8.1			8.4		46.0
	48.0				8.2			8.1	8.1			7.9		48.0
50.0				7.8			48.3m/8.1	7.7			7.5	50.1m/7.6	50.0	
52.0				7.4				7.3			51.3m/7.3	7.2	52.0	
54.0				52.5m/7.3				6.9				6.8	54.0	
56.0								55.4m/6.7				6.4	56.0	
58.0												6.1	58.0	
60.0												58.4m/6.0	60.0	
Reeves	2	2	2	2	2	2	2	2	2	2	2	2	Reeves	

45.8 m Tower Length	Tower length (m)	45.8								Tower length (m)
	Jib length (m)	36.6				39.6				Jib length (m)
	Tower angle	90°	80°	70°	60°	90°	80°	70°	60°	Tower angle
Working radius (m)	12.0	13.3m/23.9								12.0
	14.0	23.6				14.1m/22.0				14.0
	16.0	22.9				21.4				16.0
	18.0	22.2				20.8				18.0
	20.0	21.4				20.2				20.0
	22.0	20.7				19.6				22.0
	24.0	19.9				19.0				24.0
	26.0	18.8	27.2m/17.6			18.3				26.0
	28.0	16.8	16.7			16.8	28.5m/16.3			28.0
	30.0	15.2	15.0			15.2	14.9			30.0
	32.0	14.0	13.8			14.0	13.7			32.0
	34.0	12.8	12.6			12.8	12.5			34.0
	36.0	11.6	11.6			11.8	11.5			36.0
	38.0	9.3	10.9			10.8	10.8			38.0
	40.0	38.7m/8.7	10.1	40.3m/10.1		9.3	10.0			40.0
	42.0		9.5	9.5		41.7m/7.7	9.4	42.0m/9.4		42.0
	44.0		8.9	8.9			8.8	8.7		44.0
	46.0		8.4	8.3			8.2	8.1		46.0
	48.0		46.6m/8.2	7.8			7.6	7.6		48.0
	50.0			7.4			49.6m/7.2	7.2		50.0
52.0			7.0	52.2m/7.0			6.8		52.0	
54.0			6.6	6.7			6.4	54.4m/6.3	54.0	
56.0			54.2m/6.6	6.3			6.1	6.1	56.0	
58.0				6.0			57.2m/5.9	5.8	58.0	
60.0				5.7				5.5	60.0	
62.0				61.3m/5.5				5.3	62.0	
64.0								5.1	64.0	
66.0								64.3m/5.0	66.0	
Reeves	2	2	2	2	2	2	2	2	Reeves	

Note:

Ratings according to Japanese Legislation for Mobile Cranes.

Ratings shown in are determined by the strength of the boom or other structural components.

Lifting capacities may vary depending on hook used or with/without auxiliary sheave.

Please refer rated chart in operator's cabin.

LIFTING CAPACITIES



Tower Jib Lifting Capacities

Counterweight: 97.1 t
Carbody Weight: 23.1 t

Unit: metric ton

48.8 m Tower Length	Tower length (m)	48.8												Tower length (m)
	Jib length (m)	27.4				30.5				33.5				Jib length (m)
	Tower angle	90°	80°	70°	60°	90°	80°	70°	60°	90°	80°	70°	60°	Tower angle
Working radius (m)	10.0	10.9m/25.0				11.7m/25.0								10.0
	12.0	25.0				25.0				12.5m/25.0				12.0
	14.0	25.0				25.0				25.0				14.0
	16.0	25.0				25.0				24.2				16.0
	18.0	25.0				24.2				23.4				18.0
	20.0	24.2				23.5				22.6				20.0
	22.0	23.2	23.9m/21.2			22.7				21.8				22.0
	24.0	20.9	20.9			21.0	25.1m/19.7			21.0				24.0
	26.0	18.5	18.6			18.6	18.6			18.8	26.4m/18.4			26.0
	28.0	16.3	16.8			16.7	16.7			16.7	16.7			28.0
	30.0	29.9m/11.3	15.2			15.1	15.1			15.3	15.1			30.0
	32.0		14.0			12.0	13.9			14.0	13.9			32.0
	34.0		12.8			32.8m/10.6	12.7			12.1	12.7			34.0
	36.0		11.8	36.1m/11.8			11.7	37.8m/11.1		35.8m/9.2	11.7			36.0
	38.0		11.1	11.1			11.0	11.0			11.0	39.6m/10.3		38.0
	40.0		38.3m/11.0	10.4			10.3	10.3			10.2	10.2		40.0
	42.0			9.7			41.3m/9.9	9.6			9.6	9.5		42.0
	44.0			9.1				9.0			8.9	8.9		44.0
	46.0			8.6	47.3m/8.3			8.5			44.2m/8.9	8.4		46.0
	48.0			46.4m/8.5	8.2			8.0	49.4m/7.8			7.9		48.0
50.0				7.8			49.4m/7.7	7.7			7.5	51.6m/7.3	50.0	
52.0				7.4				7.3			7.1	7.2	52.0	
54.0				54.0m/7.0				6.9			52.3m/7.1	6.8	54.0	
56.0								6.5				6.4	56.0	
58.0								56.9m/6.4				6.1	58.0	
60.0												59.9m/5.8	60.0	
Reeves	2	2	2	2	2	2	2	2	2	2	2	2	Reeves	

48.8 m Tower Length	Tower length (m)	48.8												Tower length (m)
	Jib length (m)	36.6				39.6				42.7				Jib length (m)
	Tower angle	90°	80°	70°	60°	90°	80°	70°	60°	90°	80°	70°	60°	Tower angle
Working radius (m)	12.0	13.3m/23.9												12.0
	14.0	23.6				14.1m/22.0				14.9m/20.0				14.0
	16.0	22.9				21.4				19.7				16.0
	18.0	22.2				20.8				19.2				18.0
	20.0	21.4				20.2				18.6				20.0
	22.0	20.7				19.6				18.1				22.0
	24.0	19.9				19.0				17.5				24.0
	26.0	18.8	27.7m/17.0			18.3				17.0				26.0
	28.0	16.8	16.7			16.8	29.0m/15.8			16.5				28.0
	30.0	15.2	15.0			15.2	14.9			15.2	30.3m/14.7			30.0
	32.0	14.0	13.8			14.0	13.7			14.0	13.6			32.0
	34.0	12.8	12.6			12.8	12.5			12.8	12.4			34.0
	36.0	11.6	11.6			11.8	11.5			11.8	11.4			36.0
	38.0	9.3	10.9			10.8	10.8			10.9	10.6			38.0
	40.0	38.7m/8.7	10.1	41.3m/9.6		9.3	10.0			9.8	9.8			40.0
	42.0		9.5	9.4		41.7m/7.7	9.4	43.1m/9.0		8.9	9.2			42.0
	44.0		8.9	8.8			8.8	8.7		7.2	8.6	44.8m/8.3		44.0
	46.0		8.4	8.3			8.2	8.1		44.6m/6.8	8.0	7.9		46.0
	48.0		47.2m/8.1	7.8			7.6	7.6			7.4	7.4		48.0
	50.0			7.4			7.2	7.2			7.0	7.0		50.0
52.0			7.0	53.7m/6.8		50.1m/7.1	6.8			6.6	6.6		52.0	
54.0			6.6	6.7			6.4	55.9m/6.1		53.0m/6.4	6.2		54.0	
56.0			55.3m/6.4	6.3			6.1	6.1			5.9		56.0	
58.0				6.0			5.8	5.8			5.6	58.1m/5.6	58.0	
60.0				5.7			58.2m/5.8	5.5			5.4	5.4	60.0	
62.0				5.4				5.3			61.2m/5.3	5.2	62.0	
64.0				62.8m/5.3				5.1				5.0	64.0	
66.0								65.8m/4.9				4.8	66.0	
68.0												4.6	68.0	
70.0												68.7m/4.5	70.0	
Reeves	2	2	2	2	2	2	2	2	2	2	2	2	Reeves	

Note:

Ratings according to Japanese Legislation for Mobile Cranes.

Ratings shown in are determined by the strength of the boom or other structural components.

Lifting capacities may vary depending on hook used or with/without auxiliary sheave.

Please refer rated chart in operator's cabin.



Tower Jib Lifting Capacities

Counterweight: 97.1 t
Carbody Weight: 23.1 t

Unit: metric ton

51.9 m Tower Length	51.9																	
	Tower length (m)	51.9															Tower length (m)	
	Jib length (m)	27.4				30.5				33.5				36.6				Jib length (m)
Working radius (m)	Tower angle	90°	80°	70°	60°	90°	80°	70°	60°	90°	80°	70°	60°	90°	80°	70°	60°	Tower angle
10.0	10.9m/25.0					11.7m/25.0												10.0
12.0	25.0					25.0				12.5m/25.0				13.3m/23.9				12.0
14.0	25.0					25.0				25.0				23.6				14.0
16.0	25.0					25.0				24.2				22.9				16.0
18.0	25.0					24.2				23.4				22.2				18.0
20.0	24.2					23.5				22.6				21.4				20.0
22.0	23.2					22.7				21.8				20.7				22.0
24.0	20.9	24.4m/20.6				21.0	25.7m/19.0			21.0				19.9				24.0
26.0	18.5	18.6				18.6	18.6			18.8	27.0m/17.8			18.8				26.0
28.0	16.3	16.8				16.7	16.7			16.7	16.7			16.8	28.2m/16.6			28.0
30.0	29.9m/11.3	15.2				15.1	15.1			15.3	15.1			15.2	15.0			30.0
32.0		14.0				12.0	13.9			14.0	13.9			14.0	13.8			32.0
34.0		12.8				32.8m/10.6	12.7			12.1	12.7			12.8	12.6			34.0
36.0		11.8	37.1m/11.4				11.7			35.8m/9.2	11.7			11.6	11.6			36.0
38.0		11.1	11.1				11.0	38.9m/10.7			11.0			9.3	10.9			38.0
40.0		38.9m/10.8	10.4				10.3	10.3			10.2	40.6m/10		38.7m/8.7	10.1			40.0
42.0			9.7				41.8m/9.7	9.6			9.6	9.5			9.5	42.4m/9.3		42.0
44.0			9.1					9.0			8.9	8.9			8.9	8.8		44.0
46.0			8.6					8.5			44.7/8.8	8.4			8.4	8.3		46.0
48.0			47.5m/8.2	48.8m/8.0				8.0				7.9			47.7m/7.9	7.8		48.0
50.0				7.8				7.6	51.0m/7.5			7.5			7.4			50.0
52.0				7.4				50.4m/7.5	7.3			7.1	53.1m/7.0			7.0		52.0
54.0				7.0					6.9				53.4m/6.9	6.8		6.6	55.3m/6.4	54.0
56.0					55.5m/6.7				6.5					6.4		6.3	6.3	56.0
58.0									6.2					6.1		56.3m/6.3	6.0	58.0
60.0									58.5m/6.1					5.8			5.7	60.0
62.0														61.4m/5.6			5.4	62.0
64.0																	5.2	64.0
66.0																	64.4m/5.1	66.0
Reeves	2	2	2	2	2	2	2	2	2	2	2	2	2	2	2	2	2	Reeves

51.9 m Tower Length	51.9																	
	Tower length (m)	51.9															Tower length (m)	
	Jib length (m)	39.6				42.7				45.7				Jib length (m)				
Working radius (m)	Tower angle	90°	80°	70°	60°	90°	80°	70°	60°	90°	80°	70°	60°	90°	80°	70°	60°	Tower angle
14.0	14.1m/22.0					14.9m/20.0				15.7m/17.4								14.0
16.0	21.4					19.7				17.4								16.0
18.0	20.8					19.2				16.9								18.0
20.0	20.2					18.6				16.4								20.0
22.0	19.6					18.1				16.0								22.0
24.0	19.0					17.5				15.5								24.0
26.0	18.3					17.0				15.0								26.0
28.0	16.8	29.5m/15.4				16.5				14.6								28.0
30.0	15.2	14.9				15.2	30.8m/14.4			14.1								30.0
32.0	14.0	13.7				14.0	13.6			13.6	32.1m/13.4							32.0
34.0	12.8	12.5				12.8	12.4			12.6	12.3							34.0
36.0	11.8	11.5				11.8	11.4			11.6	11.3							36.0
38.0	10.8	10.8				10.8	10.6			10.6	10.5							38.0
40.0	9.3	10.0				9.8	9.8			9.7	9.7							40.0
42.0	41.7m/7.7	9.4				8.9	9.2			8.9	9.0							42.0
44.0		8.8	44.1m/8.7			7.2	8.6	45.9m/7.9		8.1	8.4							44.0
46.0		8.2	8.1			44.6m/6.8	8.0	7.9		7.1	7.8	47.6m/7.4						46.0
48.0		7.6	7.6				7.4	7.4		47.5m/6.1	7.2	7.3						48.0
50.0		7.2	7.2				7.0	7.0			6.8	6.8						50.0
52.0		50.6m/7.1	6.8				6.6	6.6			6.4	6.4						52.0
54.0			6.4				53.6m/6.2	6.2			6.0	6.0						54.0
56.0			6.1	57.4m/5.9				5.9			5.7	5.7						56.0
58.0			5.8	5.8				5.6	59.6m/5.3		56.5m/5.6	5.4						58.0
60.0			59.3m/5.6	5.5				5.4	5.3			5.2	61.7m/4.8					60.0
62.0				5.2				5.2	5.0				5.0	4.8				62.0
64.0				5.0				62.2m/5.2	4.8				4.8	4.6				64.0
66.0				4.8					4.6				65.2m/4.6	4.4				66.0
68.0				67.3m/4.6					4.4					4.2				68.0
70.0									4.2					4.0				70.0
72.0									70.2m/4.2					3.8				72.0
74.0														73.2m/3.7				74.0
Reeves	2	2	2	2	2	2	2	2	2	2	2	2	2	2	2	2	2	Reeves

Note:

Ratings according to Japanese Legislation for Mobile Cranes.

Ratings shown in are determined by the strength of the boom or other structural components.

Lifting capacities may vary depending on hook used or with/without auxiliary sheave.

Please refer rated chart in operator's cabin.

LIFTING CAPACITIES



Tower Jib Lifting Capacities

Counterweight: 97.1 t
Carbody Weight: 23.1 t

Unit: metric ton

54.9 m Tower Length	54.9																	
	Tower length (m)	54.9															Tower length (m)	
	Jib length (m)	27.4				30.5				33.5				36.6				Jib length (m)
Working radius (m)	Tower angle	90°	80°	70°	60°	90°	80°	70°	60°	90°	80°	70°	60°	90°	80°	70°	60°	Tower angle
	10.0	10.9m/25.0					11.7m/25.0											
12.0	25.0					25.0				12.5m/25.0				13.3m/23.9				12.0
14.0	25.0					25.0				25.0				23.6				14.0
16.0	25.0					25.0				24.2				22.9				16.0
18.0	25.0					24.2				23.4				22.2				18.0
20.0	24.2					23.5				22.6				21.4				20.0
22.0	23.2					22.7				21.7				20.7				22.0
24.0	20.9	24.9m/20.0				21.0				21.0				19.9				24.0
26.0	18.5	18.6				18.6	26.2m/18.6			18.8	27.5m/17.2			18.8				26.0
28.0	16.3	16.8				16.7	16.7			16.7	16.7			16.8	28.8m/16.2			28.0
30.0	29.9m/11.3	15.2				15.1	15.1			15.3	15.1			15.2	15.0			30.0
32.0		14.0				12.0	13.9			14.0	13.9			14.0	13.8			32.0
34.0		12.8				32.8m/10.6	12.7			12.2	12.7			12.8	12.6			34.0
36.0		11.8					11.7			35.8m/9.3	11.7			11.6	11.6			36.0
38.0		11.1	38.2m/11.0				11.0	39.9m/10.3			11.0			9.3	10.9			38.0
40.0			39.4m/10.6	10.4			10.3	10.3			10.2	41.7m/9.6		38.7m/8.7	10.1			40.0
42.0				9.7			9.5	9.6			9.6	9.5			9.5	43.4m/9.0		42.0
44.0				9.1			42.3m/9.5	9.0			8.9	8.9			8.9	8.8		44.0
46.0				8.6				8.5			45.3m/8.6	8.4			8.4	8.3		46.0
48.0				8.2				8.0			7.9	7.9			7.8	7.8		48.0
50.0					48.5m/8.1	50.3m/7.7		7.6			7.5				48.2m/7.8	7.4		50.0
52.0					7.4			51.5m/7.3	52.5m/7.2		7.1					7.0		52.0
54.0					7.0				6.9		6.8	54.6m/6.7				6.6		54.0
56.0					6.6				6.5			54.4m/6.7	6.4			6.3	56.8m/6.1	56.0
58.0						57.0m/6.4			6.1				6.0			57.4m/6.0	5.9	58.0
60.0									60.0m/5.8				5.7				5.6	60.0
62.0													5.4				5.3	62.0
64.0													62.9m/5.3				5.1	64.0
66.0																	65.9m/4.9	66.0
Reeves	2	2	2	2	2	2	2	2	2	2	2	2	2	2	2	2	2	Reeves

54.9 m Tower Length	54.9																	
	Tower length (m)	54.9															Tower length (m)	
	Jib length (m)	39.6				42.7				45.7				48.8				Jib length (m)
Working radius (m)	Tower angle	90°	80°	70°	60°	90°	80°	70°	60°	90°	80°	70°	60°	90°	80°	70°	60°	Tower angle
	14.0	14.1m/22.0					14.9m/20.0				15.7m/17.4							
16.0	21.4					19.7				17.4				16.5m/15.4				16.0
18.0	20.8					19.2				16.9				15.0				18.0
20.0	20.2					18.6				16.4				14.6				20.0
22.0	19.6					18.1				16.0				14.2				22.0
24.0	19.0					17.5				15.5				13.7				24.0
26.0	18.3					17.0				15.0				13.3				26.0
28.0	16.8					16.5				14.6				12.9				28.0
30.0	15.2	30.1m/14.9				15.2	31.4m/14.1			14.1				12.5				30.0
32.0	14.0	13.7				14.0	13.6	32.6m/13.4		13.6	32.6m/13.4			12.0	33.9m/12.1			32.0
34.0	12.8	12.5				12.8	12.4			12.6	12.3			11.6	12.1			34.0
36.0	11.8	11.5				11.8	11.4			11.6	11.3			10.9	11.1			36.0
38.0	10.8	10.8				10.8	10.6			10.6	10.5			10.1	10.2			38.0
40.0	9.5	10.0				9.8	9.8			9.7	9.7			9.4	9.4			40.0
42.0	41.7m/7.9	9.4				8.8	9.2			8.8	9.0			8.6	8.7			42.0
44.0		8.8	45.2m/8.3			7.3	8.6			8.1	8.4			7.9	8.1			44.0
46.0		8.2	8.1			44.6m/6.9	8.0	46.9m/7.7		7.1	7.8			7.3	7.6			46.0
48.0		7.6	7.6				7.4	7.4		47.5m/6.1	7.2	48.7m/7.1		6.6	7.0			48.0
50.0		7.2	7.2				7.0	7.0			6.8	6.8		5.6	6.6	50.4m/6.5		50.0
52.0			51.2m/6.9	6.8			6.6	6.6			6.4	6.4		50.5m/5.3	6.2	6.2		52.0
54.0				6.4			6.2	6.2			6.0	6.0			5.8	5.8		54.0
56.0				6.1							5.7	5.7			5.5	5.5		56.0
58.0				5.8	58.9m/5.7			5.6			57.0m/5.5	5.4			5.2	5.2		58.0
60.0				5.6	5.5			5.4	61.1m/5.1						60.0m/5.0	5.0		60.0
62.0					60.3m/5.6	5.2			5.2	5.0			5.0	63.3m/4.7		4.8		62.0
64.0						5.0			63.3m/5.0	4.8			4.8	4.6		4.6	65.4m/4.3	64.0
66.0						4.8				4.6			4.6	4.4		4.4	4.2	66.0
68.0						4.6				4.4			66.2m/4.6	4.2		4.2	4.0	68.0
70.0						68.8m/4.5				4.2				4.0		69.1m/4.1	3.8	70.0
72.0										71.8m/4.0				3.8			3.6	72.0
74.0														3.6			3.4	74.0
76.0															74.7m/3.5		3.2	76.0
78.0																	77.7m/3.0	78.0
Reeves	2	2	2	2	2	2	2	2	2	2	2	2	2	2	2	2	2	Reeves

Note:

Ratings according to Japanese Legislation for Mobile Cranes.

Ratings shown in are determined by the strength of the boom or other structural components.

Lifting capacities may vary depending on hook used or with/without auxiliary sheave. Please refer rated chart in operator's cabin.



Tower Jib Lifting Capacities

Counterweight: 97.1 t
Carbody Weight: 23.1 t

Unit: metric ton

58.0 m Tower Length	Tower length (m)	58.0												Tower length (m)
	Jib length (m)	27.4				30.5				33.5				Jib length (m)
	Tower angle	90°	80°	70°	60°	90°	80°	70°	60°	90°	80°	70°	60°	Tower angle
Working radius (m)	10.0	10.9m/25.0				11.7m/25.0								10.0
	12.0	25.0				25.0				12.5m/25.0				12.0
	14.0	25.0				25.0				25.0				14.0
	16.0	25.0				25.0				24.2				16.0
	18.0	24.9				24.2				23.4				18.0
	20.0	24.0				23.5				22.6				20.0
	22.0	23.0				22.7				21.7				22.0
	24.0	20.7	25.4m/19.4			21.0				21.0				24.0
	26.0	18.3	18.6			18.6	26.7m/18.1			18.8				26.0
	28.0	16.3	16.8			16.7	16.7			16.7	28.0m/16.7			28.0
	30.0	29.9m/11.3	15.2			15.1	15.1			15.3	15.1			30.0
	32.0		14.0			12.0	13.9			14.0	13.9			32.0
	34.0		12.8			32.8m/10.6	12.7			12.2	12.7			34.0
	36.0		11.8				11.7			35.8m/9.3	11.7			36.0
	38.0		11.1	39.7m/10.6			11.0				11.0			38.0
	40.0		39.9m/10.4	10.4			10.3	41.0m/10.0			10.2			40.0
	42.0			9.7			9.5	9.6			9.6	42.7m/9.2		42.0
	44.0			9.1			42.9m/9.3	9.0			8.9	8.9		44.0
	46.0			8.6				8.5			45.8m/8.5	8.4		46.0
	48.0			8.2				8.0				7.9		48.0
	50.0			49.6m/7.9	51.8m/7.4			7.6				7.5		50.0
	52.0				7.4			7.3				7.1		52.0
	54.0				7.0			52.5m/7.2	54.0m/6.9			6.8		54.0
	56.0				6.6				6.5			55.5m/6.5	56.2m/6.4	56.0
58.0				6.2				6.1				6.0	58.0	
60.0				58.6m/6.1				5.8				5.7	60.0	
62.0								61.5m/5.6				5.4	62.0	
64.0												5.1	64.0	
66.0												64.5m/5.0	66.0	
Reeves	2	2	2	2	2	2	2	2	2	2	2	2	Reeves	

58.0 m Tower Length	Tower length (m)	58.0												Tower length (m)
	Jib length (m)	36.6				39.6				42.7				Jib length (m)
	Tower angle	90°	80°	70°	60°	90°	80°	70°	60°	90°	80°	70°	60°	Tower angle
Working radius (m)	12.0	13.3m/23.9												12.0
	14.0	23.6				14.1m/22.0				14.9m/20.0				14.0
	16.0	22.9				21.4				19.7				16.0
	18.0	22.2				20.8				19.2				18.0
	20.0	21.4				20.2				18.6				20.0
	22.0	20.7				19.6				18.1				22.0
	24.0	19.9				19.0				17.5				24.0
	26.0	18.8				18.3				17.0				26.0
	28.0	16.8	29.3m/15.7			16.8				16.5				28.0
	30.0	15.2	15.0			15.2	30.6m/14.8			15.2	31.9m/13.7			30.0
	32.0	14.0	13.8			14.0	13.7			14.0	13.6			32.0
	34.0	12.8	12.6			12.8	12.5			12.8	12.4			34.0
	36.0	11.6	11.6			11.8	11.5			11.8	11.4			36.0
	38.0	9.5	10.9			10.7	10.8			10.8	10.6			38.0
	40.0	38.7m/8.9	10.1			9.5	10.0			9.8	9.8			40.0
	42.0		9.5			41.7m/7.9	9.4			8.8	9.2			42.0
	44.0		8.9	44.5m/8.7			8.8			7.4	8.6			44.0
	46.0		8.4	8.3			8.2	46.2m/8.1		44.6m/7.0	8.0			46.0
	48.0		7.8	7.8			7.6	7.6			7.4	48.0m/7.4		48.0
	50.0		48.7m/7.7	7.4			7.2	7.2			7.0	7.0		50.0
	52.0			7.0			51.7m/6.8	6.8			6.6	6.6		52.0
	54.0			6.6				6.4			6.2	6.2		54.0
	56.0			6.3				6.1			54.6m/6.1	5.9		56.0
	58.0			6.0	58.3m/5.8			5.8				5.6		58.0
60.0			58.4m/5.9	5.6			5.6	60.5m/5.3			5.4		60.0	
62.0				5.3			61.3m/5.4	5.1			5.2	62.6m/4.8	62.0	
64.0				5.0				4.8			4.9	4.6	64.0	
66.0				4.8				4.6			64.3m/4.8	4.4	66.0	
68.0				67.4m/4.6				4.4				4.2	68.0	
70.0								4.2				4.0	70.0	
72.0								70.3m/4.2				3.8	72.0	
74.0												73.3m/3.6	74.0	
Reeves	2	2	2	2	2	2	2	2	2	2	2	2	Reeves	

Note:

Ratings according to Japanese Legislation for Mobile Cranes.

Ratings shown in are determined by the strength of the boom or other structural components.

Lifting capacities may vary depending on hook used or with/without auxiliary sheave.

Please refer rated chart in operator's cabin.

LIFTING CAPACITIES



Tower Jib Lifting Capacities

Counterweight: 97.1 t
Carbody Weight: 23.1 t

Unit: metric ton

58.0 m Tower Length	Tower length (m)	58.0										Tower length (m)		
	Jib length (m)	45.7				48.8				51.8			Jib length (m)	
	Tower angle	90°	80°	70°	60°	90°	80°	70°	60°	90°	80°	70°	Tower angle	
Working radius (m)	14.0	15.7m/17.4											14.0	
	16.0	17.4				16.5m/15.4				17.2m/13.9			16.0	
	18.0	16.9				15.0				13.7			18.0	
	20.0	16.4				14.6				13.3			20.0	
	22.0	16.0				14.2				12.8			22.0	
	24.0	15.5				13.7				12.4			24.0	
	26.0	15.0				13.3				12.0			26.0	
	28.0	14.6				12.9				11.6			28.0	
	30.0	14.1				12.5				11.2			30.0	
	32.0	13.6	33.2m/12.7			12.0				10.8			32.0	
	34.0	12.6	12.3			11.6	34.5m/11.8			10.4	35.7m/10.6			34.0
	36.0	11.5	11.3			10.9	11.1			9.8	10.4			36.0
	38.0	10.6	10.5			10.1	10.2			9.1	9.7			38.0
	40.0	9.6	9.7			9.4	9.4			8.5	9.0			40.0
	42.0	8.8	9.0			8.6	8.7			7.9	8.4			42.0
	44.0	8.1	8.4			7.9	8.1			7.4	7.8			44.0
	46.0	7.1	7.8			7.3	7.6			6.9	7.3			46.0
	48.0	47.5m/6.1	7.2	49.7m/6.9		6.6	7.0			6.3	6.8			48.0
	50.0		6.8	6.8		5.6	6.6	51.5m/6.3		5.9	6.4			50.0
	52.0		6.4	6.4		50.5m/5.3	6.2	6.2		5.4	6.0	53.2m/5.7		52.0
	54.0		6.0	6.0			5.8	5.8		53.4m/4.9	5.6	5.6		54.0
	56.0		5.7	5.7			5.5	5.5			5.3	5.3		56.0
	58.0		57.6m/5.4	5.4			5.2	5.2			5.0	5.0		58.0
	60.0			5.2			5.0	5.0			4.8	4.8		60.0
	62.0			5.0			60.5m/4.9	4.8			4.6	4.6		62.0
	64.0			4.8	64.8m/4.3			4.6			63.5m/4.3	4.4		64.0
	66.0			4.6	4.2			4.4	66.9m/3.9			4.2		66.0
	68.0			67.2m/4.4	4.0			4.2	3.8			4.0		68.0
	70.0				3.8			4.0	3.6			3.8		70.0
	72.0				3.6			70.2m/4.0	3.4			3.6		72.0
74.0				3.4				3.2			73.1m/3.5		74.0	
76.0				3.2				3.0					76.0	
78.0				76.2m/3.2				2.8					78.0	
80.0								79.2m/2.7					80.0	
Reeves		2	2	2	2	2	2	2	2	2	2	2	Reeves	

Note:
 Ratings according to Japanese Legislation for Mobile Cranes.
 Ratings shown in are determined by the strength of the boom or other structural components.
 Lifting capacities may vary depending on hook used or with/without auxiliary sheave.
 Please refer rated chart in operator's cabin.



Tower Jib Lifting Capacities

Counterweight: 97.1 t
Carbody Weight: 23.1 t

Unit: metric ton

61.0 m Tower Length	61.0													Tower length (m)
	27.4				30.5				33.5				Jib length (m)	
	Tower angle	90°	80°	70°	60°	90°	80°	70°	60°	90°	80°	70°	60°	Tower angle
10.0	10.9m/25.0				11.7m/25.0					12.5m/25.0				10.0
12.0	25.0				25.0									12.0
14.0	25.0				25.0									14.0
16.0	24.6				24.6									16.0
18.0	23.7				23.7									18.0
20.0	22.9				22.7									20.0
22.0	21.5				21.5									22.0
24.0	20.0				20.0									24.0
26.0	18.3	26.0m/18.6			18.6	27.3m/17.4				18.8				26.0
28.0	16.3	16.8			16.7	16.7				16.7	28.5m/16.4			28.0
30.0	29.9m/11.3	15.2			15.1	15.1				15.3	15.1			30.0
32.0		14.0			12.0	13.9				14.0	13.9			32.0
34.0		12.8			32.8m/10.6	12.7				12.3	12.7			34.0
36.0		11.8				11.7				35.8m/9.4	11.7			36.0
38.0		11.1				11.0					11.0			38.0
40.0		10.4	40.3m/10.3			10.3					10.2			40.0
42.0		40.4m/10.2	9.7			9.5	42.0m/9.6				9.6	43.8m/8.8		42.0
44.0			9.1			43.4m/9.2	9.0				8.9	8.8		44.0
46.0			8.6				8.5				8.4	8.4		46.0
48.0			8.2				8.0				46.3m/8.4	7.9		48.0
50.0			7.8				7.6					7.5		50.0
52.0			50.6m/7.7	53.4m/6.8			7.3					7.1		52.0
54.0				6.7			53.6m/6.9	55.5m/6.4				6.7		54.0
56.0				6.4				6.3				6.4	57.7m/5.7	56.0
58.0				6.1				6.0				56.5m/6.3	5.7	58.0
60.0				5.8				5.7					5.5	60.0
62.0				60.1m/5.8				5.4					5.2	62.0
64.0								63.0m/5.2					5.0	64.0
66.0													4.8	66.0
68.0													66.0m/4.8	68.0
Reeves	2	2	2	2	2	2	2	2	2	2	2	2	2	Reeves

61.0 m Tower Length	61.0													Tower length (m)
	36.6				39.6				42.7				Jib length (m)	
	Tower angle	90°	80°	70°	60°	90°	80°	70°	60°	90°	80°	70°	60°	Tower angle
12.0	13.3m/23.9													12.0
14.0	23.6				14.1m/22.0					14.9m/20.0				14.0
16.0	22.9				21.4					19.7				16.0
18.0	22.2				20.8					19.2				18.0
20.0	21.4				20.2					18.6				20.0
22.0	20.7				19.6					18.1				22.0
24.0	19.9				19.0					17.5				24.0
26.0	18.8				18.3					17.0				26.0
28.0	16.8	29.8m/15.2			16.8					16.5				28.0
30.0	15.2	15.0			15.2	31.1m/14.3				15.2				30.0
32.0	14.0	13.8			14.0	13.7				14.0	32.4m/13.5			32.0
34.0	12.8	12.6			12.8	12.5				12.8	12.4			34.0
36.0	11.5	11.6			11.8	11.5				11.8	11.4			36.0
38.0	9.5	10.9			10.7	10.8				10.8	10.6			38.0
40.0	38.7m/8.9	10.1			9.5	10.0				9.8	9.8			40.0
42.0		9.5			41.7m/7.9	9.4				8.9	9.2			42.0
44.0		8.9	45.5m/8.4			8.8				7.4	8.6			44.0
46.0		8.4	8.3			8.2	47.3m/7.8			44.6m/6.9	8.0			46.0
48.0		7.8	7.8			7.6	7.6				7.4	49.0m/7.2		48.0
50.0		49.3m/7.5	7.4			7.2	7.2				7.0	7.0		50.0
52.0			7.0			6.8	6.8				6.6	6.6		52.0
54.0			6.6			52.2m/6.8	6.4				6.2	6.2		54.0
56.0			6.3				6.1				55.2m/5.9	5.9		56.0
58.0			6.0	59.8m/5.3			5.8					5.6		58.0
60.0			59.4m/5.8	5.3			5.6					5.4		60.0
62.0				5.1			5.4	62.0m/4.9				5.2		62.0
64.0				4.9			62.4m/5.3	4.7				5.0	64.1m/4.0	64.0
66.0				4.7				4.5				65.3m/4.9	4.0	66.0
68.0				4.4				4.2					3.8	68.0
70.0				68.9m/4.3				3.9					3.6	70.0
72.0								3.6					3.4	72.0
74.0								71.9m/3.6					3.2	74.0
76.0													74.8m/3.1	76.0
Reeves	2	2	2	2	2	2	2	2	2	2	2	2	2	Reeves

Note:

Ratings according to Japanese Legislation for Mobile Cranes.

Ratings shown in are determined by the strength of the boom or other structural components.

Lifting capacities may vary depending on hook used or with/without auxiliary sheave.

Please refer rated chart in operator's cabin.

LIFTING CAPACITIES



Tower Jib Lifting Capacities

Counterweight: 97.1 t
Carbody Weight: 23.1 t

Unit: metric ton

61.0 m Tower Length	Tower length (m)	61.0										Tower length (m)	
	Jib length (m)	45.7				48.8				51.8			Jib length (m)
	Tower angle	90°	80°	70°	60°	90°	80°	70°	60°	90°	80°	70°	Tower angle
Working radius (m)	14.0	15.7m/17.4											14.0
	16.0	17.4				16.5m/15.4				17.2m/13.9			16.0
	18.0	16.9				15.0				13.7			18.0
	20.0	16.4				14.6				13.3			20.0
	22.0	16.0				14.2				12.8			22.0
	24.0	15.5				13.7				12.4			24.0
	26.0	15.0				13.3				12.0			26.0
	28.0	14.6				12.9				11.6			28.0
	30.0	14.1				12.5				11.2			30.0
	32.0	13.6	33.7m/12.6			12.0				10.8			32.0
	34.0	12.6	12.3			11.6	35.0m/11.4			10.4			34.0
	36.0	11.5	11.3			10.8	11.0			9.8	36.3m/9.7		36.0
	38.0	10.4	10.5			9.9	10.1			9.1	9.3		38.0
	40.0	9.5	9.7			9.3	9.3			8.5	8.7		40.0
	42.0	8.7	9.0			8.5	8.6			7.9	8.2		42.0
	44.0	8.1	8.4			7.8	8.0			7.4	7.6		44.0
	46.0	7.2	7.8			7.3	7.5			6.9	7.1		46.0
	48.0	47.5m/6.2	7.2			6.6	6.9			6.3	6.6		48.0
	50.0		6.8	50.8m/6.7		5.6	6.5			5.8	6.2		50.0
	52.0		6.4	6.4		50.5m/5.3	6.1	52.5m/6.0		5.3	5.8		52.0
	54.0		6.0	6.0			5.7	5.7		53.4m/4.9	5.4	54.2m/5.3	54.0
	56.0		5.7	5.7			5.4	5.4			5.1	5.1	56.0
	58.0		5.4	5.4			5.1	5.1			4.8	4.8	58.0
	60.0		58.1m/5.4	5.2			4.9	4.9			4.6	4.6	60.0
	62.0			5.0			61.0m/4.7	4.7			4.4	4.4	62.0
	64.0			4.8				4.5			64.0m/4.1	4.2	64.0
	66.0			4.6	66.3m/3.7			4.3				4.0	66.0
	68.0			4.3	3.5			4.1				3.8	68.0
	70.0			68.3m/4.3	3.3			3.9	70.0m/3.1			3.6	70.0
	72.0				3.1			71.2m/3.8	2.9			3.4	72.0
74.0				2.9				2.7			3.2	74.0	
76.0				2.7				2.5			74.2m/3.2	76.0	
78.0				77.8m/2.5				78.0m/2.3				78.0	
	Reeves	2	2	2	2	2	2	2	2	2	2	Reeves	

Note:
Ratings according to Japanese Legislation for Mobile Cranes.
Ratings shown in are determined by the strength of the boom or other structural components.
Lifting capacities may vary depending on hook used or with/without auxiliary sheave.
Please refer rated chart in operator's cabin.



Tower Jib Lifting Capacities

Counterweight: 97.1 t
Carbody Weight: 23.1 t

Unit: metric ton

64.1 m Tower Length	64.1													Tower length (m)
	27.4				30.5				33.5				Jib length (m)	
	Tower angle	90°	80°	70°	60°	90°	80°	70°	60°	90°	80°	70°	60°	Tower angle
10.0	10.9m/25.0				11.7m/25.0					12.5m/24.8				10.0
12.0	25.0				25.0									12.0
14.0	24.3				24.3					24.3				14.0
16.0	23.6				23.6					23.6				16.0
18.0	22.9				22.9					22.9				18.0
20.0	22.2				22.2					22.0				20.0
22.0	21.5				21.5					21.0				22.0
24.0	20.0				20.0					20.0				24.0
26.0	18.3	26.5m/18.3			18.6	27.8m/15.9				18.8				26.0
28.0	16.3	16.8			16.7	16.7				16.7	29.1m/15.9			28.0
30.0	29.9m/11.3	15.2			15.1	15.1				15.3	15.1			30.0
32.0		14.0			12.0	13.9				14.0	13.9			32.0
34.0		12.8			32.8m/10.6	12.7				12.3	12.7			34.0
36.0		11.8				11.7				35.8m/9.4	11.7			36.0
38.0		11.1				11.0					11.0			38.0
40.0		10.4	41.3m/9.9			10.3					10.2			40.0
42.0		41.0m/10.0	9.7			9.5	43.1m/9.3				9.6			42.0
44.0			9.1			43.9m/9.0	9.0				8.9	44.8m/8.7		44.0
46.0			8.6				8.5				8.4	8.4		46.0
48.0			8.2				8.0				46.9m/8.2	7.9		48.0
50.0			7.8				7.6					7.5		50.0
52.0			51.7m/7.4				7.3					7.1		52.0
54.0				54.9m/6.0			6.9					6.7		54.0
56.0				5.9			54.6m/6.7	57.1m/5.4				6.4		56.0
58.0				5.7				5.3				57.5m/6.2	59.2m/4.9	58.0
60.0				5.5				5.1					4.8	60.0
62.0				61.6m/5.3				4.9					4.6	62.0
64.0								4.7					4.4	64.0
66.0								64.6m/4.6					4.2	66.0
68.0													67.5m/4.0	68.0
Reeves	2	2	2	2	2	2	2	2	2	2	2	2	2	Reeves

Working radius (m)	64.1													Tower length (m)
	36.6				39.6				42.7				Jib length (m)	
	Tower angle	90°	80°	70°	60°	90°	80°	70°	60°	90°	80°	70°	60°	Tower angle
12.0	13.3m/23.9													12.0
14.0	23.6					14.1m/22.0				14.9m/20.0				14.0
16.0	22.9					21.4				19.7				16.0
18.0	22.2					20.8				19.2				18.0
20.0	21.4					20.2				18.6				20.0
22.0	20.7					19.6				18.1				22.0
24.0	19.9					19.0				17.5				24.0
26.0	18.8					18.3				17.0				26.0
28.0	16.8					16.8				16.5				28.0
30.0	15.2	30.4m/14.9				15.2	31.7m/13.9			15.2				30.0
32.0	14.0	13.8				14.0	13.7			14.0	32.9m/13.3			32.0
34.0	12.8	12.6				12.8	12.5			12.8	12.4			34.0
36.0	11.5	11.6				11.8	11.5			11.8	11.4			36.0
38.0	9.5	10.9				10.7	10.8			10.8	10.6			38.0
40.0	38.7m/8.9	10.1				9.5	10.0			9.7	9.8			40.0
42.0		9.5				41.7m/7.9	9.4			8.8	9.2			42.0
44.0		8.9					8.8			7.4	8.6			44.0
46.0		8.4	46.5m/8.1				8.2			44.6m/6.9	8.0			46.0
48.0		7.8	7.8				7.6	48.3m/7.6			7.4			48.0
50.0		49.8m/7.4	7.4				7.2	7.2			7.0	50.0m/7.0		50.0
52.0			7.0				6.7	6.8			6.6	6.6		52.0
54.0			6.6				52.7m/6.6	6.4			6.1	6.2		54.0
56.0			6.3					6.1			55.7m/5.8	5.9		56.0
58.0			6.0					5.8				5.6		58.0
60.0			5.7	61.4m/4.5				5.6				5.4		60.0
62.0			60.5m/5.6	4.4				5.4	63.5m/4.0			5.2		62.0
64.0				4.2				63.4m/5.3	4.0			5.0		64.0
66.0				4.0					3.8			4.8	66.0m/3.4	66.0
68.0				3.8					3.6			66.4m/4.7	3.4	68.0
70.0				3.6					3.4				3.2	70.0
72.0				70.5m/3.5					3.2				3.0	72.0
74.0									73.4m/3.0				74.0m/2.8	74.0
Reeves	2	2	2	2	2	2	2	2	2	2	2	2	2	Reeves

Note:

Ratings according to Japanese Legislation for Mobile Cranes.

Ratings shown in are determined by the strength of the boom or other structural components.

Lifting capacities may vary depending on hook used or with/without auxiliary sheave.

Please refer rated chart in operator's cabin.

LIFTING CAPACITIES



Tower Jib Lifting Capacities

Counterweight: 97.1 t

Carbody Weight: 23.1 t

Unit: metric ton

64.1 m Tower Length	Tower length (m)	64.1									Tower length (m)	
	Jib length (m)	45.7			48.8			51.8			Jib length (m)	
	Tower angle	90°	80°	70°	90°	80°	70°	90°	80°	70°	Tower angle	
Working radius (m)	14.0	15.7m/17.4										14.0
	16.0	17.4			16.5m/15.4			17.2m/13.9				16.0
	18.0	16.9			15.0			13.7				18.0
	20.0	16.4			14.6			13.3				20.0
	22.0	16.0			14.2			12.8				22.0
	24.0	15.5			13.7			12.4				24.0
	26.0	15.0			13.3			11.9				26.0
	28.0	14.6			12.9			11.5				28.0
	30.0	14.1			12.5			11.1				30.0
	32.0	13.6			12.0			10.8				32.0
	34.0	12.6	34.2m/12.3		11.6	35.5m/11.4		10.4				34.0
	36.0	11.5	11.3		10.8	11.0		9.8	36.8m/9.2			36.0
	38.0	10.4	10.5		9.9	10.1		9.1	9.0			38.0
	40.0	9.5	9.7		9.3	9.3		8.5	8.4			40.0
	42.0	8.7	9.0		8.5	8.6		7.9	7.9			42.0
	44.0	7.9	8.4		7.8	8.0		7.4	7.3			44.0
	46.0	7.1	7.8		7.1	7.5		6.8	6.8			46.0
	48.0	47.5m/6.2	7.2		6.4	6.9		6.2	6.3			48.0
	50.0		6.8	51.8m/6.4	5.6	6.5		5.6	5.9			50.0
	52.0		6.4	6.4	50.5m/5.3	6.1	53.5m/5.8	5.0	5.5			52.0
	54.0		6.0	6.0		5.7	5.7	53.4m/4.5	5.1	55.3m/4.9		54.0
	56.0		5.7	5.7		5.4	5.4		4.8	4.8		56.0
	58.0		5.4	5.4		5.1	5.1		4.5	4.5		58.0
	60.0		58.6m/5.3	5.2		4.9	4.9		4.3	4.3		60.0
	62.0			5.0		61.6m/4.7	4.7		4.1	4.1		62.0
	64.0			4.8			4.5		3.8	3.9		64.0
	66.0			4.6			4.3		64.5m/3.7	3.7		66.0
68.0			4.4			4.1			3.5		68.0	
70.0			69.3m/4.3			3.9			3.3		70.0	
72.0						3.8			3.1		72.0	
74.0						72.3m/3.7			3.0		74.0	
76.0									75.2m/2.9		76.0	
	Reeves	2	2	2	2	2	2	2	2	2	Reeves	

Note:

Ratings according to Japanese Legislation for Mobile Cranes.

Ratings shown in are determined by the strength of the boom or other structural components.

Lifting capacities may vary depending on hook used or with/without auxiliary sheave.

Please refer rated chart in operator's cabin.

- Operating radius is the horizontal distance from centerline of rotation to a vertical line through the center of gravity of the load.
- Deduct weight of bucket, slings and all other load handling accessories from main boom ratings shown.
- Ratings shown are based on freely suspended loads and make no allowance for such factors as wind effect on lifted load, ground conditions, out-of-level, operating speeds or any other condition that could be detrimental to the safe operation of this equipment. The operator, therefore, has the responsibility to judge the existing conditions and reduce lifted loads and operating speeds accordingly.
- Rated loads do not exceed 66% of minimum tipping loads.
- Ratings are for operation on a firm and level surface, up to 1% gradient.
- At radii and boom lengths where no ratings are shown on chart, operation is not intended nor approved.
- Boom inserts and guy lines must be arranged as shown in the "Operator's Manual".
- Boom hoist reeving is 16 part line.
- Gantry must be in raised position for all conditions.
- Boom backstops are required for all boom lengths.
- The boom should be erected over the front of the crawlers, not laterally.

(Clamshell bucket lifting)

- The total load that can be lifted is the value for weight of bucket, slings, and all other load handling accessories deducted from main boom ratings shown.
- The weight of bucket and materials must not exceed rated load.
- Optimum bucket should be required according to material. $\text{Bucket capacity (m}^3\text{)} \times \text{specified gravity of material (ton/m}^3\text{)} + \text{bucket weight (ton)} = \text{rated load}$.
- Bucket weight must also be decreased according to operating cycle and bucket lowering height.
- Rated loads are determined by stability and boom strength. During simultaneous operations of boom and swing, rapid acceleration or deceleration must be avoided.
- Do not attempt to cast the bucket while swinging or diagonal draw-cutting.

<Reference Information>

Main hoist loads

No. of Parts of Line	1
Maximum Loads (kN)	123
Maximum Loads (t)	12.5

Assembling the counterweight

75.1 ton counterweight
without carbody weight

No.5		No.6
No.4		
No.3		
No.2		
No.1		

Counterweights



Carbody weights

Operation of this equipment in excess of rated loads or disregard of instruction voids the warranty.

LIFTING CAPACITIES



Clamshell Rating Charts Crane Boom Capacities

Counterweight: 75.1 t

Unit: metric ton

Working radius (m) \ Boom length (m)	18.3	21.3	24.4	27.4	30.5	33.5	Boom length (m) \ Working radius (m)
8.0	12.5						8.0
9.0	12.5	12.5					9.0
10.0	12.5	12.5	12.5				10.0
11.0	12.5	12.5	12.5	12.5			11.0
12.0	12.5	12.5	12.5	12.5	12.5		12.0
13.0	12.5	12.5	12.5	12.5	12.5	12.5	13.0
14.0	12.5	12.5	12.5	12.5	12.5	12.5	14.0
15.0	12.5	12.5	12.5	12.5	12.5	12.5	15.0
16.0	12.5	12.5	12.5	12.5	12.5	12.5	16.0
17.0		12.5	12.5	12.5	12.5	12.5	17.0
18.0		12.5	12.5	12.5	12.5	12.5	18.0
19.0		12.5	12.5	12.5	12.5	12.5	19.0
20.0			12.5	12.5	12.5	12.5	20.0
21.0			12.5	12.5	12.5	12.5	21.0
22.0			12.5	12.5	12.5	12.5	22.0
23.0				12.5	12.5	12.5	23.0
24.0				12.5	12.5	12.5	24.0
25.0					12.5	12.5	25.0
26.0					12.5	12.5	26.0
27.0					12.5	12.3	27.0
28.0						12.0	28.0
29.0						11.7	29.0
Reeves	1	1	1	1	1	1	Reeves

Note:
Please refer rated chart in operator's cabin.



SUPPLEMENTAL DATA FOR REDUCED WEIGHTS RATING CHART

- Ratings according to Japanese Construction Codes for Mobile Cranes.
- Operating radius is the horizontal distance from centerline of rotation to a vertical line through the center of gravity of the load.
- Deduct weight of hook block (s), slings and all other load handling accessories from main boom ratings shown.
- Ratings shown are based on freely suspended loads and make no allowance for such factors as wind effect on lifted load, ground conditions, out-of-level, operating speeds or any other condition that could be detrimental to the safe operation of this equipment. The operator, therefore, has the responsibility to judge the existing conditions and reduce lifted loads and operating speeds accordingly.
- Ratings are for operation on a firm and level surface, up to 1% gradient.
- At radii and boom lengths where no ratings are shown on chart, operation is not intended nor approved.
- Boom inserts and guy lines must be arranged as shown in the "Operator's Manual".
- Boom hoist reeving is 16 part line.
- Gantry must be in raised position for all conditions.
- Boom backstops are required for all boom lengths.
- The boom should be erected over the front of the crawlers, not laterally.
- Ratings inside of boxes are limited by strength of materials.
- The minimum rated load is 2.4 (ton).
- When erecting and lowering the boom length of 76.2 m with fixed jib, the blocks for erection must be placed at the end of the crawlers.

(Crane boom)

- The total load that can be lifted is the value for weight of hook block, slings, and all other load handling accessories deducted from main boom ratings shown.

<Reference Information>

Main hoist loads

No. of Parts of Line	1	2	3	4	5
Maximum Loads (kN)	132	265	397	530	662
Maximum Loads (t)	13.5	27.0	40.5	54.0	67.5

No. of Parts of Line	6	7	8	9	10
Maximum Loads (kN)	794	927	1,059	1,192	1,324
Maximum Loads (t)	81.0	94.5	108.0	121.5	135.0

No. of Parts of Line	11	12	14	16	18
Maximum Loads (kN)	1,456	1,530	1,785	1,961	2,206
Maximum Loads (t)	148.5	156.0	182.0	200.0	225.0

No. of Parts of Line	22
Maximum Loads (kN)	2,452
Maximum Loads (t)	250.0

Auxiliary hoist loads

No. of Parts of Line	1	2
Maximum Loads (kN)	132	265
Maximum Loads (t)	13.5	27.0

Weight of hook block					
Hook Block	250 t	150 t	70 t	35 t	Ball Hook
Weight (t)	4.2	2.3	1.2	0.9	0.45

Assembling the counterweight

75.1 ton counterweight
without carbody weight

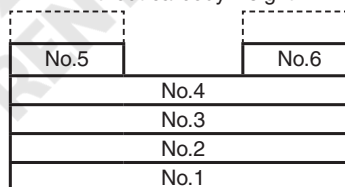

Counterweights

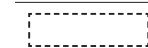

Carbody weights

- The lifting capacity does not change due to the type of counterweights.

Operation of this equipment in excess of rated loads or disregard of instruction voids the warranty.

LIFTING CAPACITIES



Reduced Weights Rating Charts Crane Boom Lifting Capacities

Counterweight: 75.1 t

Unit: metric ton

Working radius (m)	Boom length (m)	Lifting Capacity (t)											Working radius (m)	
		15.2	18.3	21.3	24.4	27.4	30.5	33.5	36.6	39.6	42.7	45.7		
4.6	4.6m/231.7													4.6
5.0	214.7	5.0m/214.3	5.5m/194.9											5.0
6.0	181.2	181.0	180.6	6.1m/175.6	6.6m/156.0									6.0
7.0	148.6	148.4	148.2	148.2	148.1	7.1m/141.7	7.7m/128.5							7.0
8.0	124.3	124.2	124.1	124.1	124.0	123.9	123.8	8.2m/117.3	8.7m/107.1					8.0
9.0	104.3	104.2	104.1	104.1	104.0	103.9	103.8	103.8	103.8	9.2m/98.6	9.8m/90.4			9.0
10.0	88.2	88.1	87.9	87.9	87.8	87.7	87.5	87.5	87.4	87.3	87.2			10.0
12.0	67.1	66.9	66.7	66.6	66.5	66.4	66.2	66.2	66.0	65.9	65.7			12.0
14.0	53.9	53.7	53.4	53.3	53.2	53.0	52.8	52.8	52.6	52.4	52.3			14.0
16.0	14.8m/49.9	44.7	44.4	44.2	44.0	43.9	43.7	43.7	43.5	43.3	43.1			16.0
18.0		17.5m/39.8	37.8	37.7	37.4	37.3	37.0	37.0	36.8	36.6	36.4			18.0
20.0			32.9	32.7	32.4	32.2	32.0	31.9	31.7	31.5	31.3			20.0
22.0			20.1m/32.7	28.8	28.5	28.3	28.0	28.0	27.8	27.5	27.3			22.0
24.0				22.7m/27.6	25.3	25.1	24.8	24.8	24.5	24.3	24.1			24.0
26.0					25.4m/23.5	22.5	22.2	22.2	21.9	21.7	21.5			26.0
28.0						28.0m/20.4	20.1	20.0	19.7	19.5	19.3			28.0
30.0							18.2	18.1	17.9	17.6	17.4			30.0
32.0							30.7m/17.7	16.6	16.3	16.0	15.8			32.0
34.0								33.3m/15.7	14.9	14.6	14.4			34.0
36.0									35.9m/13.8	13.4	13.2			36.0
38.0										12.4	12.1			38.0
40.0										38.6m/12.1	11.2			40.0
42.0											41.2m/10.7			42.0
Reeves	20	18	16	14	12	11	10	9	8	8	7			Reeves

Working radius (m)	Boom length (m)	Lifting Capacity (t)											Working radius (m)
		48.8	51.8	54.9	57.9	61.0	64.0	67.1	70.1	73.2	76.2		
10.0	10.3m/81.0	10.8m/76.7	11.4m/71.1	11.9m/65.8									10.0
12.0	65.7	65.5	65.3	65.3	12.4m/61.0	12.9m/56.3	13.5m/51.6						12.0
14.0	52.3	52.1	51.9	51.8	51.6	51.4	50.8	14.0m/47.6	14.5m/43.1	15.1m/37.1			14.0
16.0	43.1	42.8	42.6	42.5	42.4	42.2	42.1	41.9	41.3	36.0			16.0
18.0	36.4	36.1	35.9	35.8	35.7	35.4	35.4	35.1	35.0	33.7			18.0
20.0	31.3	31.0	30.8	30.7	30.5	30.3	30.2	30.0	29.8	29.8			20.0
22.0	27.3	27.0	26.8	26.7	26.5	26.3	26.2	26.0	25.8	25.7			22.0
24.0	24.1	23.8	23.6	23.4	23.3	23.0	23.0	22.7	22.5	22.5			24.0
26.0	21.4	21.1	20.9	20.8	20.6	20.4	20.3	20.0	19.9	19.8			26.0
28.0	19.2	18.9	18.7	18.5	18.4	18.1	18.0	17.8	17.6	17.5			28.0
30.0	17.3	17.0	16.8	16.6	16.5	16.2	16.1	15.9	15.7	15.6			30.0
32.0	15.7	15.4	15.2	15.0	14.9	14.6	14.5	14.2	14.1	14.0			32.0
34.0	14.3	14.0	13.8	13.6	13.4	13.2	13.1	12.8	12.6	12.5			34.0
36.0	13.1	12.8	12.5	12.4	12.2	11.9	11.8	11.6	11.4	11.3			36.0
38.0	12.0	11.7	11.5	11.3	11.1	10.8	10.7	10.5	10.3	10.2			38.0
40.0	11.1	10.8	10.5	10.3	10.1	9.9	9.7	9.5	9.3	9.2			40.0
42.0	10.2	9.9	9.6	9.4	9.3	9.0	8.9	8.6	8.4	8.3			42.0
44.0	43.9m/9.5	9.1	8.9	8.7	8.5	8.2	8.1	7.8	7.6	7.5			44.0
46.0		8.5	8.2	8.0	7.8	7.5	7.4	7.1	6.9	6.8			46.0
48.0		46.5m/8.3	7.6	7.3	7.2	6.9	6.7	6.4	6.3	6.1			48.0
50.0			49.1m/7.3	6.8	6.6	6.3	6.1	5.9	5.6	5.4			50.0
52.0				51.8m/6.3	6.1	5.8	5.6	5.2	5.0	4.8			52.0
54.0					5.6	5.3	5.0	4.6	4.4	4.1			54.0
56.0					54.4m/5.5	4.7	4.5	4.0	3.8	3.6			56.0
58.0						57.1m/4.5	4.0	3.5	3.3	3.0			58.0
60.0							59.7m/3.6	3.1	2.8	2.6			60.0
62.0								2.6	2.4				62.0
64.0								62.3m/2.6					64.0
Reeves	6	6	6	5	5	5	4	4	4	3			Reeves

Note:

Ratings according to Japanese Construction Codes for Mobile Cranes. Ratings shown in [] are determined by the strength of the boom or other structural components. Lifting capacities may vary depending on hook used or with/without auxiliary sheave. Please refer rated chart in operator's cabin.

SUPPLEMENTAL DATA FOR BARGE RATING CHART

- Operating radius is the horizontal distance from centerline of rotation to a vertical line through the center of gravity of the load.
- Deduct weight of hook block (s), slings and all other load handling accessories from main boom ratings shown.
- Condition of barge stability this rating chart were determined under the condition below. The stability of barge shall meet below condition. During operation the machinery static inclination against horizontal level.
 - (A) Both sides (right & left) of machine
Maximum inclination shall be within 1.5 degrees
 - (B) Front & backward of machine
Maximum inclination shall be within 3.0 degrees

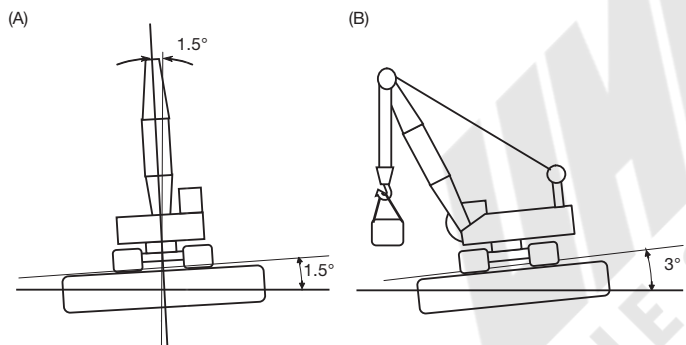
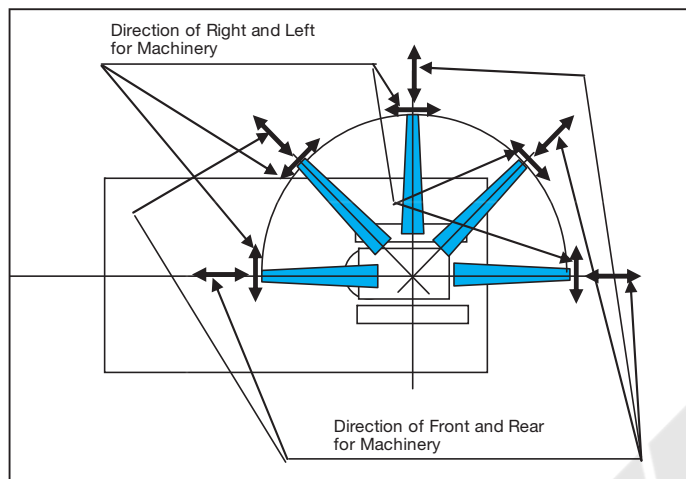

- Working area shall be inshore and smooth water.
- Applicable regulations for structure
- Japanese construction codes for mobile crane
 - ※ Regulation of class of shipping (abs, lloyd, bv, nk, etc) are not adapted.
- At radii and boom lengths where no ratings are shown on chart, operation is not intended nor approved.
- Boom inserts and guy lines must be arranged as shown in the "Operator's Manual".
- Boom hoist reeving is 16 part line.
- Gantry must be in raised position for all conditions.
- Boom backstops are required for all boom lengths.
- The boom should be erected over the front of the crawlers, not laterally.
- Ratings inside of boxes are limited by strength of materials.
- The minimum rated load is 2.4 (ton).
- The machinery should be fastened to the deck of the barge to prevent tip over and sliding.

- Towing area
Towing area shall be within coastal area and quiet wave condition. Offshore and open sea is not considered for this machinery. Depend on the height of wave, counterweight shall be reduced during towing.

(Crane boom)

- The total load that can be lifted is the value for weight of hook block, slings, and all other load handling accessories deducted from main boom ratings shown.

(Main boom with auxiliary sheave frame)

- The total load that can be lifted is the value for weight of main hook block, slings, and all other load handling accessories deducted from main boom with auxiliary sheave ratings shown.

(Auxiliary sheave)

- The total load that can be lifted is the value for weight of auxiliary sheave hook block, slings, and all other load handling accessories deducted from auxiliary sheave ratings shown.

<Reference Information>

Main hoist loads

No. of Parts of Line	1	2	3	4	5
Maximum Loads (kN)	132	265	397	530	662
Maximum Loads (t)	13.5	27.0	40.5	54.0	67.5

No. of Parts of Line	6	7	8	10
Maximum Loads (kN)	794	927	1,059	1,275
Maximum Loads (t)	81.0	94.5	108.0	130.0

Auxiliary hoist loads

No. of Parts of Line	1
Maximum Loads (kN)	132
Maximum Loads (t)	13.5

Weight of hook block					
Hook Block	250 t	150 t	70 t	35 t	Ball Hook
Weight (t)	4.2	2.3	1.2	0.9	0.45

Operation of this equipment in excess of rated loads or disregard of instruction voids the warranty.

Assembling the counterweight

75.1 ton counterweight without carbody weight

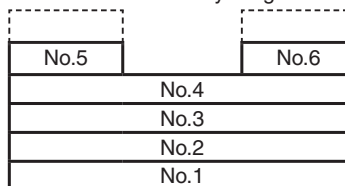

Counterweights

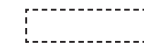

Carbody weights

- Counterweight shall be reduced to 75.1 ton, and carbody weight shall be removed.

	On Barge	On Gound (full c/w)
Boom Length	18.3 m to 54.9 m	15.2 m to 76.2 m
Counterweight	75.1 t	97.1 t
Carbody weight	None (Removed)	23.1 t

LIFTING CAPACITIES



Barge Rating Charts Crane Boom Lifting Capacities

Counterweight: 75.1 t

Unit: metric ton

Working radius (m)	Boom length (m)									Boom length (m)	Working radius (m)
		18.3	21.3	24.4	27.4	30.5	33.5	36.6	39.6		
6.0	130.0	6.6m/114.0									6.0
7.0	109.0	107.2	7.3m/103.0								7.0
8.0	93.5	93.1	92.7	92.5	8.7m/82.5						8.0
9.0	82.6	82.2	81.8	81.4	81.1	9.4m/75.0					9.0
10.0	73.8	73.4	73.0	72.7	72.4	72.1	10.1m/67.5	10.7m/62.0	11.4m/56.5		10.0
12.0	58.4	60.3	59.9	59.6	59.2	58.9	58.6	58.2	55.6		12.0
14.0	47.1	48.9	49.1	49.8	49.9	49.6	49.3	49.0	48.7		14.0
16.0	38.1	40.1	40.5	41.4	42.1	42.6	42.3	42.0	41.7		16.0
18.0	17.5m/29.6	33.4	34.1	35.0	35.5	36.2	36.7	36.4	36.2		18.0
20.0		26.6	29.2	29.9	30.5	31.0	31.5	31.5	31.3		20.0
22.0		20.1m/26.1	25.3	25.9	26.5	27.0	27.4	27.6	27.4		22.0
24.0			22.7m/23.1	22.8	23.3	23.7	24.0	24.2	24.1		24.0
26.0				25.4m/20.6	20.6	21.1	21.4	21.5	21.6		26.0
28.0					18.4	18.7	19.0	19.2	19.4		28.0
30.0						16.8	17.1	17.3	17.5		30.0
32.0						30.7m/16.1	15.5	15.6	16.0		32.0
34.0							33.3m/14.5	14.2	14.5		34.0
36.0								35.9m/12.9	13.4		36.0
38.0									12.4		38.0
40.0									38.6m/12.1		40.0
Reeves	10	9	8	7	7	6	5	5	5		Reeves

Working radius (m)	Boom length (m)					Boom length (m)	Working radius (m)
		45.7	48.8	51.8	54.9		
12.0	12.1m/52.0	12.8m/48.0	13.5m/43.8			12.0	
14.0	48.5	46.2	43.2	14.2m/40.5		14.0	
16.0	41.4	40.9	40.8	38.7		16.0	
18.0	35.9	35.4	35.2	35.0		18.0	
20.0	31.2	31.0	30.8	30.5		20.0	
22.0	27.2	27.0	26.8	26.6		22.0	
24.0	24.0	23.8	23.6	23.4		24.0	
26.0	21.4	21.2	21.0	20.7		26.0	
28.0	19.2	19.0	18.7	18.5		28.0	
30.0	17.3	17.1	16.9	16.6		30.0	
32.0	15.8	15.5	15.3	15.0		32.0	
34.0	14.3	14.1	13.9	13.7		34.0	
36.0	13.2	12.9	12.6	12.4		36.0	
38.0	12.2	11.9	11.6	11.3		38.0	
40.0	11.2	10.9	10.6	10.4		40.0	
42.0	41.2m/10.7	10.1	9.8	9.6		42.0	
44.0		43.9m/9.3	9.0	8.8		44.0	
46.0			8.4	8.1		46.0	
48.0			46.5m/8.3	7.5		48.0	
50.0				49.1m/7.2		50.0	
Reeves	4	4	4	3		Reeves	

Note:

Ratings according to Japanese Construction Codes for Mobile Cranes.

Ratings shown in are determined by the strength of the boom or other structural components.

Lifting capacities may vary depending on hook used or with/without auxiliary sheave.

Please refer rated chart in operator's cabin.

TRANSPORTATION PLAN

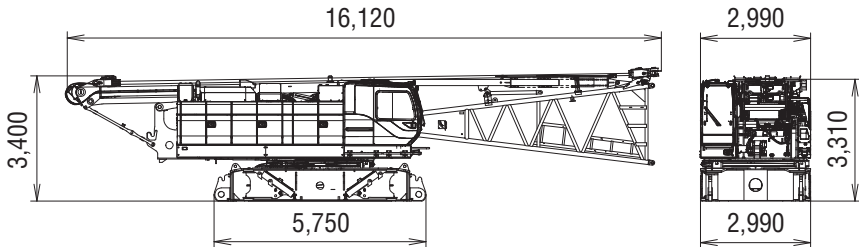
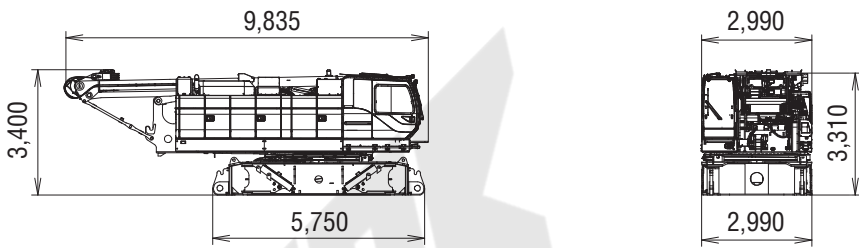
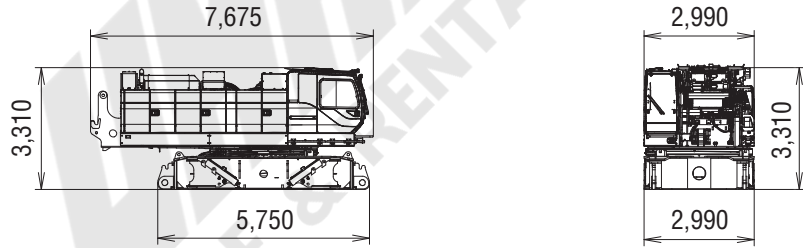
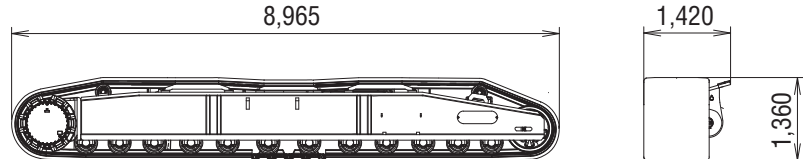
Name	Dimension	Weight (kg)
Base machine <ul style="list-style-type: none"> • Boom base • Gantry • Wire rope (Front / rear / boom hoist) • Crane backstop • Without crawler 		45,200
Base machine <ul style="list-style-type: none"> • Gantry • Wire rope (Front / rear / boom hoist) • Without crawler 		40,200
Base machine <ul style="list-style-type: none"> • Without crawler • Without gantry • Without wire rope (Front / rear / drum) • Without boom hoist winch 		32,000
Crawler		20,300

PARTS AND ATTACHMENTS

Base Machine

Gantry, Wire rope (Front/rear/boom hoist)
Crane backstop, Without crawler
Weight: 45,200 kg Width: 2,990 mm

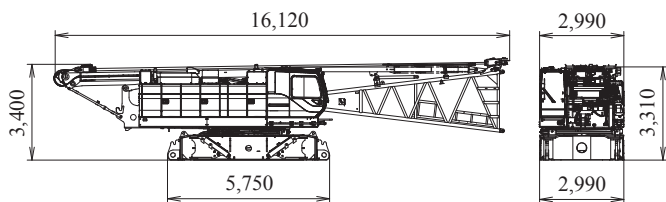

Crawler

Weight: 20,300 kg

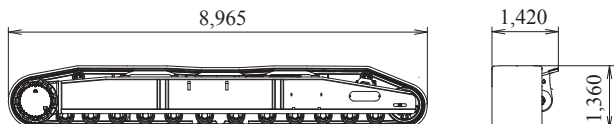

Gantry

Weight: 2,830 kg

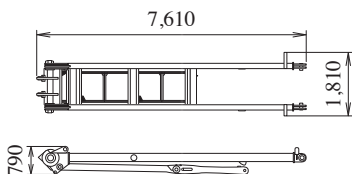

Counterweight (1)

Weight: 13,500 kg

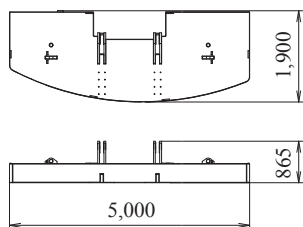

Counterweight (2)

Weight: 13,200 kg

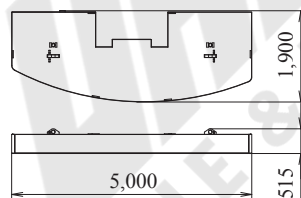

Counterweight (3)

Weight: 13,200 kg

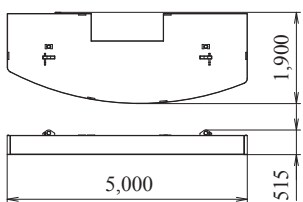

Counterweight (4)

Weight: 13,190 kg

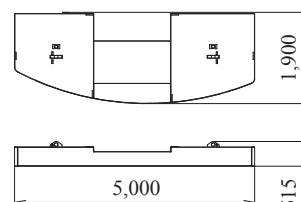

Counterweight (L) (5) (7)

Weight: 10,080 kg

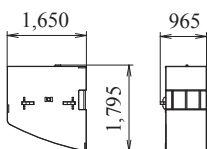

Counterweight (R) (6) (8)

Weight: 11,925 kg

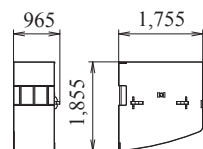

Carbody Weight

Weight: 11,535 kg

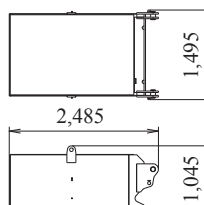

Boom Top

Weight: 3,860 kg

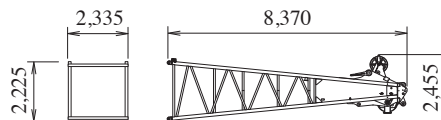

Boom Top (for Long Boom and Tower Jib)

Weight: 1,120 kg

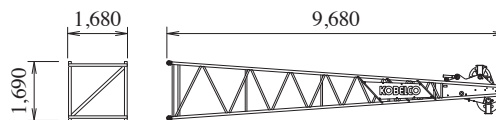

Boom Base (with Backstop)

Weight: 4,180 kg

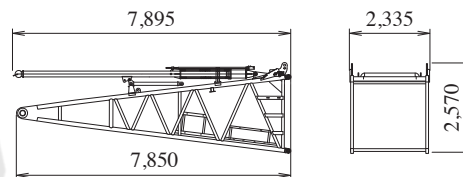

3.0 m Insert Boom

Weight: 740 kg

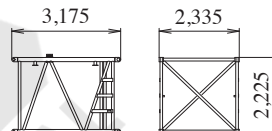

6.1 m Insert Boom

Weight: 1,210 kg

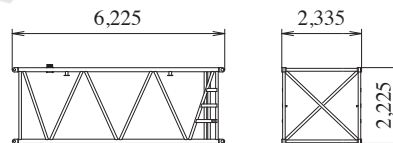

12.2 m Insert Boom

Weight: 2,150 kg

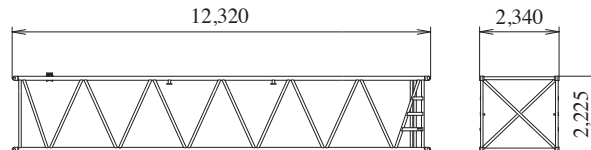

9.1 m Special Insert Boom for Tower

Weight: 2,200 kg

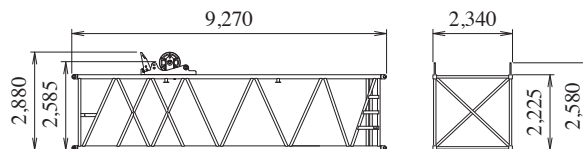

Insert Tapered Boom

Weight: 1,160 kg

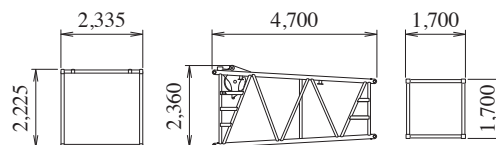

Jib Top (for Crane)

Weight: 315 kg

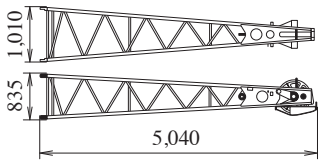

Jib Base (for Crane)

Weight: 210 kg

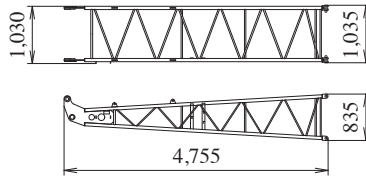

Jib Strut

Weight: 300 kg

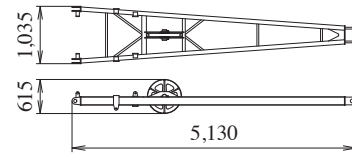

3.0 m Insert Jib

Weight: 110 kg

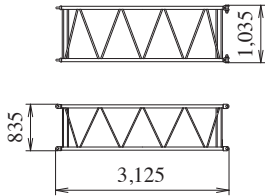

6.1 m Insert Jib

Weight: 190 kg

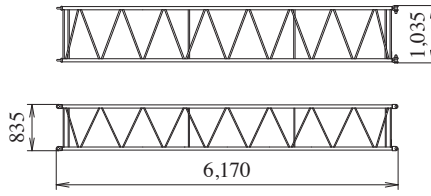

Tower Jib Base

Weight: 1,710 kg

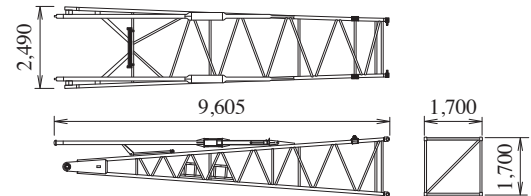

3.0 m Insert Tower Jib

Weight: 320 kg

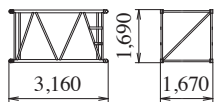

6.1 m Insert Tower Jib

Weight: 530 kg

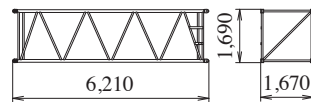

9.1 m Insert Tower Jib

Weight: 740 kg

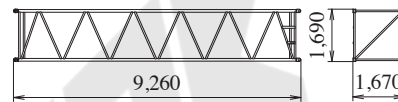

Attachments	Weight	Dimensions (L x W x H)
Relay jib	400 kg (with guy cables)	3,170 mm x 1,670 mm x 1,690 mm
Trans-lifter	395 kg	1,145 mm x 400 mm x 1,390 mm

Upper Spreader

Weight: 670 kg

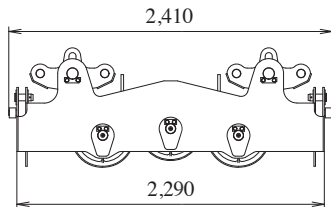

Lower Spreader

Weight: 400 kg

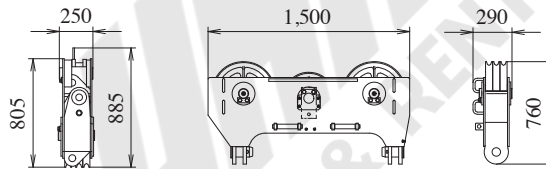

Tower Cap

Weight: 2,310 kg

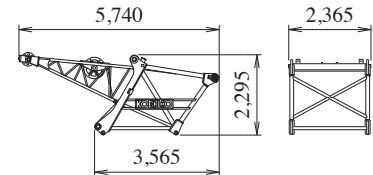

Upper Spreader (for Tower Jib)

Weight: 260 kg

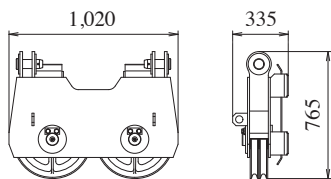

Lower Spreader (for Tower Jib)

Weight: 490 kg

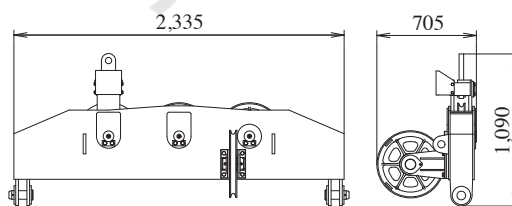

Tower Strut

Weight: 2,190 kg

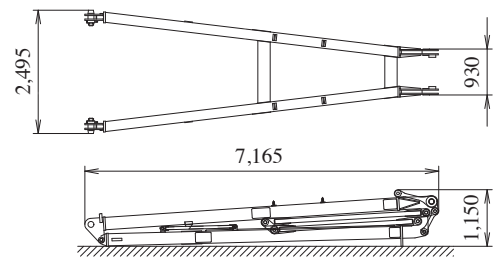

250 t Hook

Weight: 4,200 kg

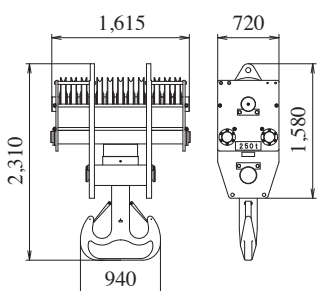

150 t Hook

Weight: 2,300 kg

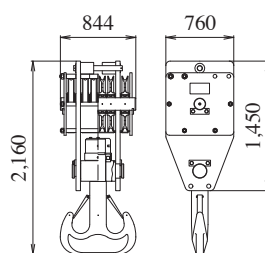

70 t Hook

Weight: 1,200 kg

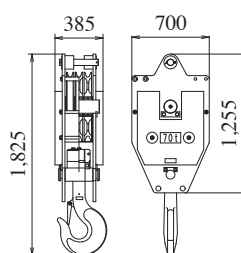

35 t Hook

Weight: 900 kg

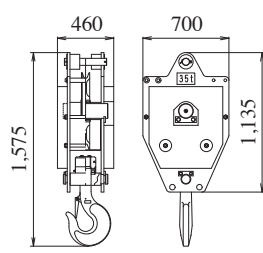

Ball Hook

Weight: 450 kg

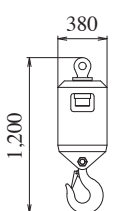

Note: Estimated weights may vary ± 2%.

WMAK
SALE & RENTAL

Note: This catalog may contain photographs of machines with specifications, attachments and optional equipment not certified for operation in your country. Please consult KOBELCO for those items you may require. Due to our policy of continual product improvements all designs and specifications are subject to change without advance notice.

Copyright by KOBELCO CRANES CO., LTD. No part of this catalog may be reproduced in any manner without notice.

KOBELCO CRANES CO., LTD.

17-1, Higashigotanda 2-chome, Shinagawa-ku, Tokyo 141-8626 JAPAN

Tel: +81-3-5789-2130 Fax: +81-3-5789-3372

URL: <http://www.kobelco-cranes.com/>

Inquiries To: