

HYDRAULIC CRAWLER CRANE

7120

Crane Boom

Max. Lifting Capacity:

120t at 5.0m

Tower Jib

Max. Lifting Capacity:

20t at 15.0m



A Crane in a Class of its Own

Hydraulic Crawler Crane 7120

The Difference is in its Basic Performance

KOBELCO's 7120 hydraulic crawler crane features new technologies that raise performance to a new height. Precise, high-elevation crane jobs depend on accuracy and speed, while lifting for general construction jobs demands reliable safety and a sufficient working area. The versatile 7120 fully meets all of these requirements in one, tough unit. Its powerful hoist winches can easily handle precise, continuous jobs, while the new hydraulic system, working in combination with a large drum capacity, delivers ultra-smooth operation.

Of course, KOBELCO is renowned for its productivity-boosting technical advances, backed by extensive worldwide experience in the construction machinery field. The 7120 exemplifies this engineering excellence, offering reliable durability, excellent lifting performance, economical transportation, smooth control functions and a wide range of safety features. In short, the 7120 can handle all types of crane jobs, ensuring utmost customer satisfaction.



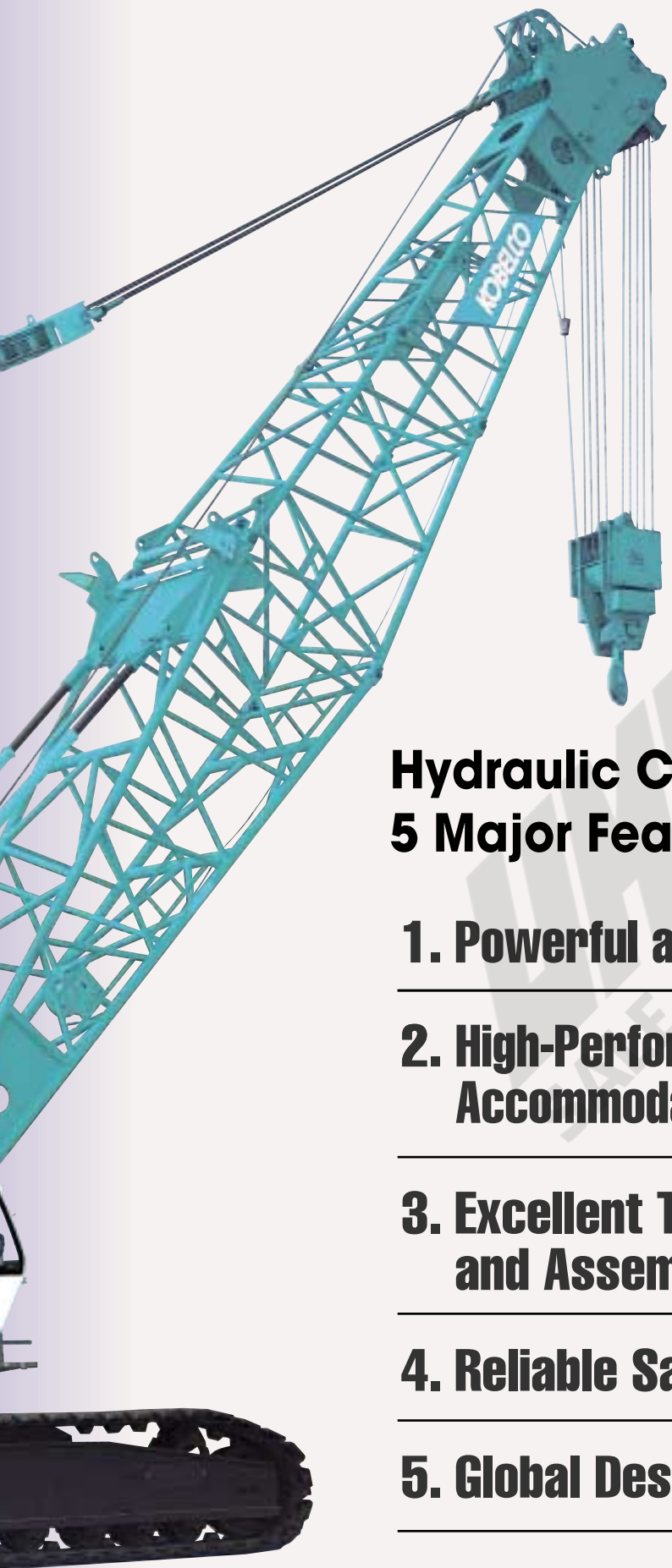

Hydraulic Crawler Crane 7120 5 Major Features

1. Powerful and Versatile Performance

**2. High-Performance Winch
Accommodates a Wide Range of Jobs**

**3. Excellent Transportability
and Assembly**

4. Reliable Safety Features

5. Global Design Super-structure

For both high and heavy lifting

Powerful and Versatile Performance

Large Lifting Capacity

Max. lifting capacity

120t at 5.0m

Tower jib max. lifting capacity

20t at 15.0m

Long Boom Configuration to Achieve Wider Working Ranges

The long boom specification provides a wider operating range with plenty of lifting capacity. The maximum working radius is 64.9m with a lifting capacity of 2.2 metric tons.

Long boom length

61.0m to 79.2m

Lifting capacity at the max. working radius

2.2t at 64.9m

(using the long 73.2m boom)

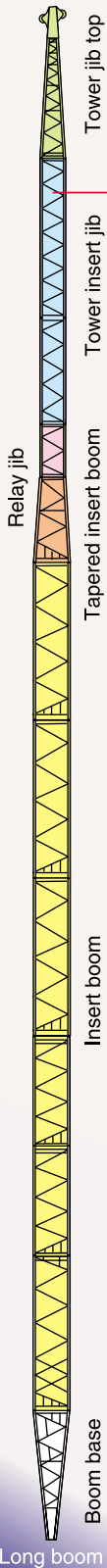



New Hydraulic System Improves Simultaneous Operations

In a conventional series hydraulic circuit (a conflux hydraulic circuit), the boom winch is driven by the same hydraulic pump that drives the main or auxiliary winches. This can result in hydraulic pressure interference that reduces line speed when the hook and boom are hoisted or lowered simultaneously.

The 7120 features independent hydraulic circuits for the main, auxiliary, and boom hoist winches, thereby eliminating interference. The circuits can be operated simultaneously with lower shocks and virtually no speed reductions, regardless of winch speed or load condition.

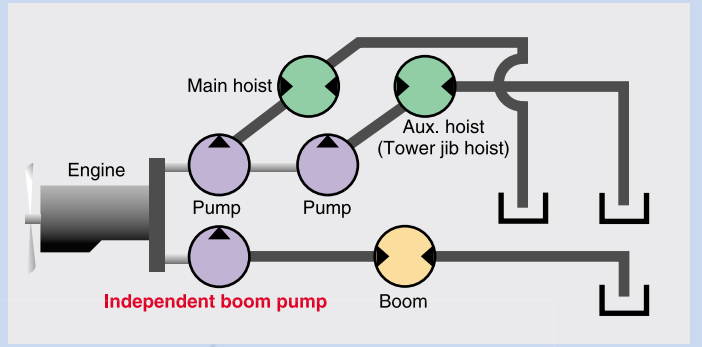

30.5m Fixed Jib, the Longest in its Class

The maximum length of the fixed jib installed on the crane boom is extended up to 30.5m, making work at higher and deeper sites possible.

Jib length **12.2m to 30.5m**

High Traveling Speed for On-Site Maneuverability

Max. travel speed **1.3km/h**

High-Output Engine

The engine has an impressive rated output of 247 kW and complies with NRMM (Europe) Stage IIIA and US EPA Tier III exhaust emissions regulations. All of this power works with KOBELCO's unique Engine Speed Sensing (ESS) control system and new hydraulic systems to ensure stable and smooth simultaneous operations.

High-Speed Lifting Increases Work Efficiency

The main and auxiliary winches deliver a fast maximum hoisting and lowering speed of 120 m/min that improves operational efficiency on high-rise jobs.

Max. line speed **120m/min** (First layer)

Control Levers Connected Directly to Pilot Valves for Smooth Operation

The control levers regulate the pilot valves directly to reduce the amount of play and ensure smooth, precise hoisting start-ups and inching. Control is light and sure, with almost no clatter even over long operating periods.

Winch Speed Controller

The speeds of the main winch, auxiliary winch and boom hoist can be set independently with trimmer controls.



■ Hydraulic pilot system detects swing reaction force.



■ Electric throttle with a twist grip ensures sensitive engine control.

■ Red switch on the boom lever grip allows easy inching control for hoist, boom hoist, and travel. The operator can activate it without taking his hands off the boom hoist lever.

■ The drum turning sensor enables sensing start of hoisting and lowering (main and aux winches only) by touching the top of the hoisting lever grip (optional).



Selectable Swing Modes to Match the Job at Hand

■ Free Swing Mode (High/Low):

This mode is designed for material handling and other cycle-duty operations that require consecutive swing cycles. The swing is completely free and can be operated at High or Low speed to suit job requirements.

■ Neutral Brake Swing Mode:

When the crane is working on a slope in Free Swing Mode, it may swing in an unintended direction as soon as



the swing parking brake is released. To prevent this, the Neutral Brake Swing Mode reduces operating speeds by lowering the flow of oil in the hydraulic circuit, thus making swing starts and stops easy to control when working on a slope or in windy conditions.

Swing speed is also reduced in this mode to prevent the load from moving sideways.

Durable operation for toughest jobs

High-Performance Winch Accommodates a Wide Range of Jobs



Wide, Large-Capacity Winches for Smooth High-Rise Work

The wide hoist winches provide an impressive spooling capacity of 50.2 m (24 rows) on the first layer with a 26 mm hoist rope. Their large capacity and large diameter help to prevent uneven spooling and wear while ensuring smooth operation when using a long boom for high-rise work.

Winches with a Powerful Line Pull Handle Hard Work with Ease

Through the efficient match-up of a high-output engine and high-performance hydraulic motors, the winches deliver plenty of line pull for single-line work. It can easily perform continuous, hard work such as construction material handling at high lifting heights.

Rated line-pull (main/aux.)

118kN {12.0 tf}

Large Third Winch

Because of a compact winch design and side engine layout, the optional third winch is almost identical in size to the main and auxiliary winches, allowing for more attachment options and better operation coordination.



The optional third winch is only available with non free-fall function.

Choice of Two Types of Winch

The 7120 features a non free-fall winch as standard that provides constant hydraulic power to the winches to prevent accidental free-fall through operator error. An optional free-fall winch (with wet-type disc brake) is also available, which delivers highly reliable performance for material handling and general foundation work.

Non Free Fall Winch (Standard)

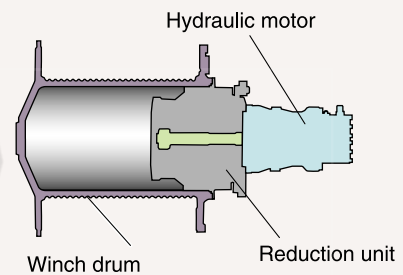

Wet-Type Multi Disc Brake System (Optional)

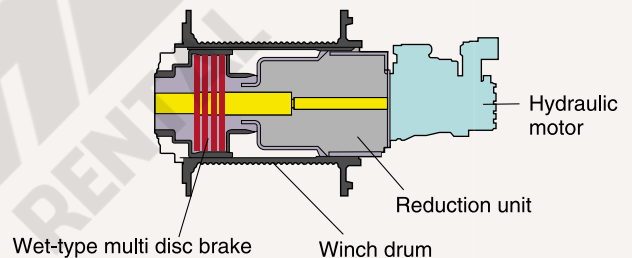

KOBELCO's new oil cooled wet-type multi disc brake system provides quiet, dependable braking power. Multiple discs are self-adjusting and self equalizing. Forced oil circulation keeps brake temperatures cooler during long, continuous operations and maximizes smooth brake operation. The completely enclosed system eliminates the possibility of outside contamination, providing years of problem-free service life. The low brake pedal effort reduces operator fatigue when the machine is working in the optional free-fall mode.

Maintenance-Free Winches

Both types of winches are maintenance-free. The built-in wet-type disc brake for the free-fall winch has a forced-oil cooling system to prevent overheating, and requires no band adjustment or lining replacement.

Environmentally Friendly Design

Because there's no brake band, the brake operates quietly and doesn't generate lining dust.

For better man-machine communication

Multi-Function LMI Display

Multi-Function LMI Display

The newly designed load moment indicator (LMI) system features a large, easy-to-read LCD display. The rated load, actual load, load ratio, and other information are displayed in large characters. Warnings and other items are displayed in color, and text messages and alarms alert the operator to prevent dangerous conditions from developing. Other information can also be displayed, including a rated load chart and rated load curve, in addition to a function that regulates the working range.



Overload prevention display (Overload alarm display)



Overload and Boom over-hoist alarm display



Boom over-hoist alarm display



Rated load display



Rated load curve display



Working area limit display

Multi Display



The easy-to-read LCD multi display provides information on the current status of such functions as engine rpm, maintenance, and on-board trouble-shooting, so that the operator has an ongoing, real-time assessment of the machine's condition at a glance.

• Normal displays

- Engine speed (Lifting height^{*1})
- Engine oil change interval
- Reeving number for main/aux. winch wire rope
- Low-speed switch status
- Wind speed^{*2}

^{*1} With the optional lifting height gauge installed

^{*2} With optional anemometer installed

• Warning displays

- Warning (malfunction, maintenance information, etc.)
- Self-diagnostic function (detects malfunctions in solenoid valves, sensors, etc.)

Side-Engine Layout for Easy Maintenance

A new engine layout on the side of the machine provides easy access for routine inspections and servicing. Maintenance crews can access the entire power plant just by opening the side door.

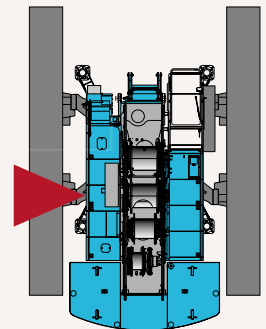

To ensure safe assembly and increase actual working hours

Excellent Transportability and Assembly

Transport with Boom Base

Transport weight **36.8t**
 Transport width **3,200mm**

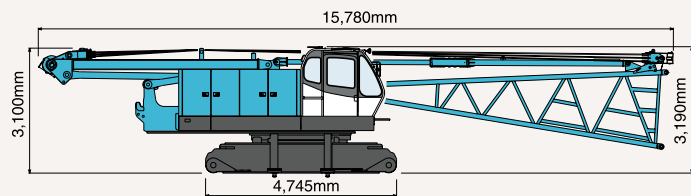

Faster Attachment Transport and Assembly

A variety of new mechanisms greatly reduce the time needed to assemble attachments. This results in lower labor and assist-crane costs, and greater productivity on the job.

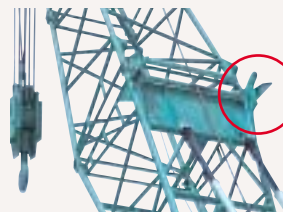

■ The upper spreader storage guides make it easy to connect guy cables.

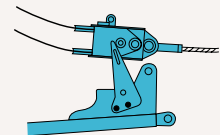

■ Large-tapered guy cable pin makes assembly easy.

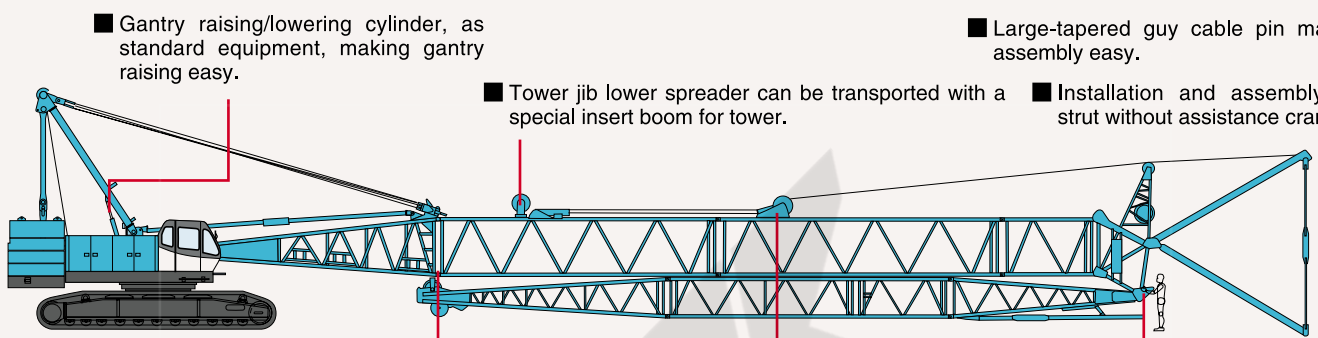

■ Gantry raising/lowering cylinder, as standard equipment, making gantry raising easy.

■ Tower jib lower spreader can be transported with a special insert boom for tower.

■ Installation and assembly of strut without assistance crane.

■ Crawler connection to carbody by hydraulic pin system makes assembly and disassembly easy.
 ■ Switching from/to the tower and crane specifications without relocating the boom upper spreader.

■ Jib upper spreader does not need to be unloaded even when being stored at a depot.
 ■ Boom base connecting tapered pins at both ends, which helps safe connection and disconnection of boom inserts from outside the boom.

■ Jib foot pin is set at a height that ensures safe assembly and disassembly from the ground.

Basic Tower Configuration Able to be Assembled by Cantilever

Thanks to the boom base with enhanced strength, cantilever of the boom is made possible up to 36.6m, in case of the crane specification, and up to 30.4m, in case of tower specification, simplifying the assembly procedures.

Thin Counterweights with Excellent Transportation Efficiency

The counterweights with a 6-pieces pilling up system and weight of 6.1 tons to 10.0 tons each are easy to handle for transportation. Furthermore they also can be transported together with the insert boom contributing to the saving of transportation vehicles.

Nested Booms Improve Transport Efficiency

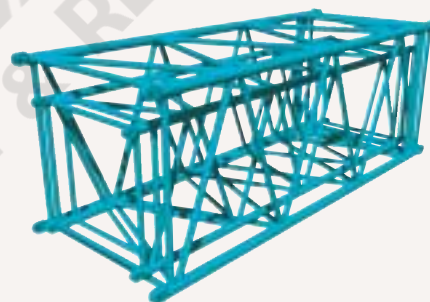

The tower insert jib can be easily nested in the insert boom by using the optional stowing guide rollers. This reduces the number of trailers needed for transport and helps to minimize required storage space.

Boom Assembly/Disassembly Mode

The boom assembly/disassembly mode, which is used to release the over-hoist prevention function to facilitate boom assembly and disassembly, is activated with a switch located under the multi-function LCD display of the load moment indicator (LMI). (This switch is different from the switch that releases the auto-stop functions for over-load and hook over-hoist.) When the boom is lifted to a certain angle, it is automatically deactivated and the LMI function is automatically re-engaged to ensure that the boom assembly/disassembly function is used only when needed.



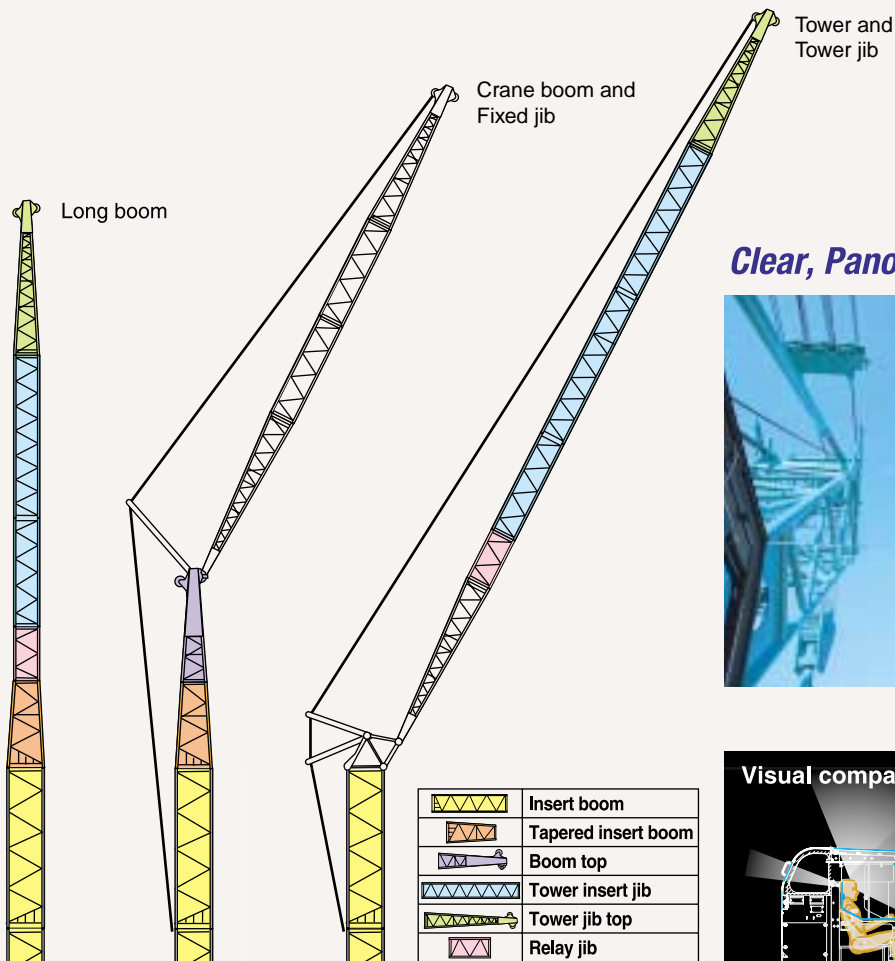

Clear, Panoramic View



The 7120 has a new cabin design with sash-less front and top glass that provides a panoramic frontward and skylight view. The glass also has less curvature to minimize distortion. The front upper window has been broadened on both sides for a view that is 31% wider than a conventional cab, while the top-window view is widened toward the rear.

Saving Storage and Transport Costs through the Common Use of Boom and Jib

The 7120 features an innovative boom design to enhance lifting performance. The common use of the boom and jib reduces labor when changing configurations and saves storage and transport costs.

Visual comparison of new and conventional cabins

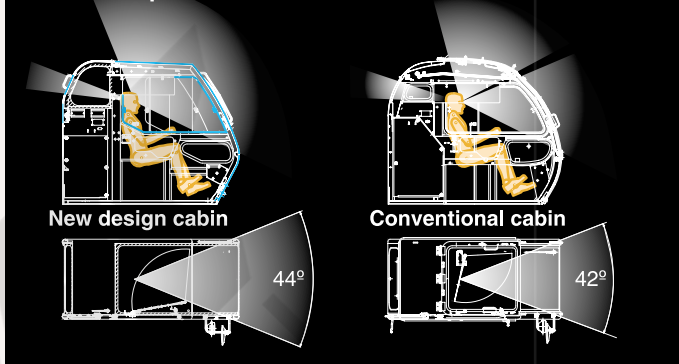

Comfortable 940mm-Wide Cab

- Air conditioner
- Fully adjustable, high backed seat with a head-rest and arm rests
- Intermittent wipers and window washers
- Cup holder
- Luggage tray



Luggage tray



Cup holder

No compromise in KOBELCO's safety policy

Reliable Safety Features

Two-Stage System to Prevent Boom and Jib Over-Hoists

With primary and secondary over-hoist prevention devices, this new safety system can prevent boom over-hoist at two stages. The primary stop function is activated when the boom or tower approaches the critical angle-to-ground during hoisting. This new system monitors the angle-to-ground of the boom, tower or jib with a sensor, and swiftly alerts the operator of danger. For the tower, the angle-to-machine is also monitored at this stage. The secondary stop function uses a device that monitors the angle-to-machine of the boom, tower or jib through a limit switch fitted to the boom and jib backstops. It stops the machine automatically to prevent it from working outside of the safety range, and once activated it cannot be cancelled.

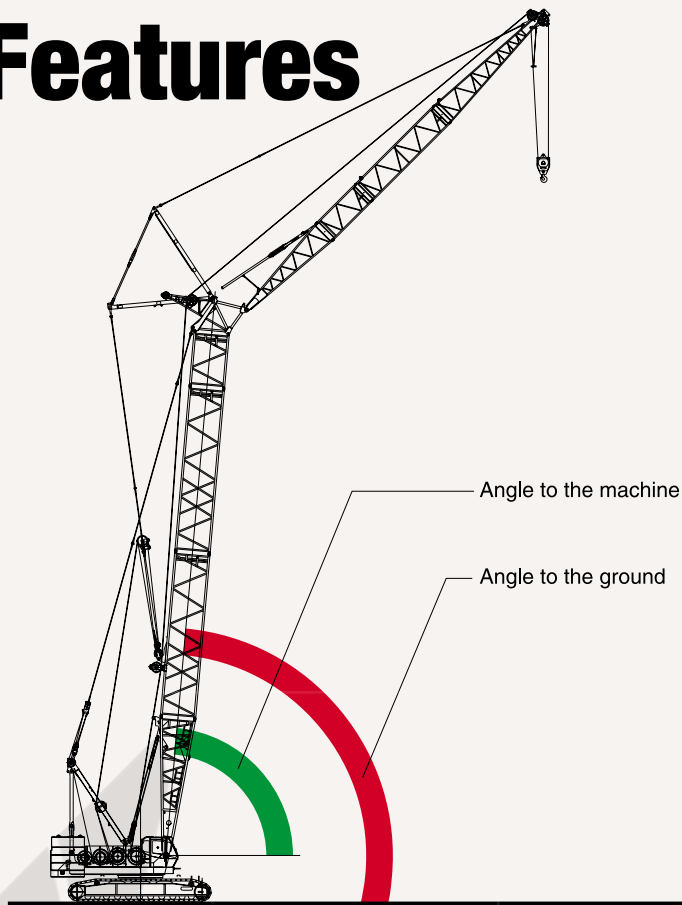

Automatic Soft-Stop Function Reduces Shocks

This function is activated automatically when boom or tower jib lowering, or boom hoisting is stopped by the over-load prevention system and the over-hoist prevention system. It makes for a smooth stop and reduces dangerous swinging of the load.



Automatic Stop Release Switch with Safety Function

The automatic stop system prevents over-load, hook over-hoist and boom over-hoist. To deactivate the system, a two-stage release procedure is employed that uses a master key and separate switches. This makes it easy to supervise the use of the single key and prevent unauthorized release of the automatic stop system.

Safety Functions of the Optional Free-fall Winch

Free-fall with Monitoring and Lock Functions

Free-fall operations can only be initiated by releasing the lock using a key switch. Unless the lock is released, free-fall cannot occur even if the switch is put in the "neutral-free" position. Also, to prevent the free-fall mode from being activated accidentally because of system malfunction, a monitoring function monitors the free-fall clutch cylinder pressure in the winch.

Free-fall Switch with Interlock



The free-fall switches are strategically located on the hoist levers, allowing the operator to engage free-fall without removing his hands from the control levers. To prevent the load from accidentally dropping, the interlock function makes it impossible to initiate free-fall unless the foot brake is fully depressed.



To prevent the load from accidentally dropping because of operator error, do not use free-fall during lifting work.

Other Safety Systems

- Function lock lever helps prevent accidental operation when the operator enters or leaves the cab.
- Directional markings on the crawlers make it easy to see which direction the crawlers will move.
- Swing flashers and warning buzzer warn surrounding workers when the machine is swinging.
- One-way call supports the safety of onsite personnel (optional).
- External lamp for over-load alarm notifies surrounding workers of the load condition (optional).
- Cameras and color monitor provide views of the rear of the machine, the main and auxiliary winches, and the boom hoist winch (optional).



• Function lock lever



• Directional markings on the crawlers



• One-way call (optional)

For the satisfaction of every user

**HYDRAULIC
CRAWLER CRANE
7120**

Global Design Super-Structure

The Global Design Super-Structure

The Global Design Super-Structure is the ultimate answer to user needs for all over the world.

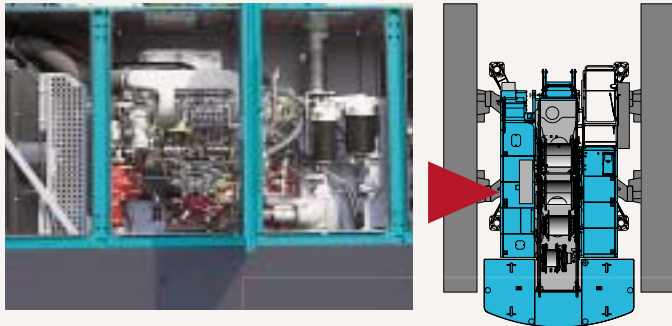

Versatile Operation

The 7120 has the power, structural strength, safety specs, and nimble operability needed to accommodate all kinds of jobs, from standard crane work to high-rise lifting and construction material handling work.

Super-Fine Filter, a Long-Life Filter for Hydraulic Oil

The large-capacity, super-fine filter is made of a high-performance filter medium consisting of glass fiber reinforced with steel wires. The replacement cycle is extended to four times longer than that of conventional filters to reduce lifelong operating costs.

Photomicrograph (× 250)



Super fine filter
(glass fiber)



Conventional filter
(paper fiber)



Complies with Worldwide Exhaust Gas Regulations

With its low pollution engine, the 7120 meets NRMM (Europe) Stage IIIA and U.S. EPA tier III exhaust emissions regulations.

Complies with Japanese Noise Regulations

The 7120 is designed with advanced Kobelco low-noise construction technologies, as specified by the Japanese Ministry of Land, Infrastructure and Transport.



■ Main Specification (Model: 7120-1F)

Crane Boom	
Max. Lifting Capacity	120 t/5.0 m
Max. Length	61.0 m
Long Boom	
Max. Lifting Capacity	24 t/16.0 m
Max. Length	79.2 m
Fixed Jib	
Max. Lifting Capacity	12 t/28.0 m
Max. Combination	61.0 m + 30.5 m
Tower Jib	
Max. Lifting Capacity	20 t/15.0 m
Max. Combination	51.7 m + 44.2 m
Tower Angle	60°~90°
Main & Aux. Winch	
Max. Line Speed	120 m/min (1st layer)
Rated Line Pull (Single line)	118 kN {12.0 tf}
Wire Rope Diameter	26 mm
Wire Rope Length	Crane 275 m (Main) 255 m (Aux.)
	Tower 290 m (Main) 145 m (Aux.)
Brake Type	Spring set hydraulically released multiple disc brake(Negative)
Free-Fall Brake Type	Wet-type multiple disc brake (Optional)

Working Speed	
Swing Speed	2.1 min ⁻¹ {rpm}
Travel Speed	1.3/0.9 km/h
Power Plant	
Model	Hino P11C-UN
Engine Output	247 kW/2,000 min ⁻¹ {rpm}
Fuel Tank Capacity	400 liters
Hydraulic System	
Main Pumps	4 variable displacement
Max. Pressure	31.9 MPa {325 kgf/cm ² }
Hydraulic Tank Capacity	535 liters
Weight	
Operating Weight*	Approx. 120 t
Ground Pressure*	94 kPa {0.96 kgf/cm ² }
Counterweight	52.3 t
Transport Weight**	Approx. 36.8 t

Units are SI units. { } indicates conventional units.

* Including upper and lower machine, 52.3 ton counterweight, basic boom, hook, and other accessories.

**Base machine with boom base, gantry, carbody, lower spreader and upper spreader.

■ General Dimensions (Unit:mm)

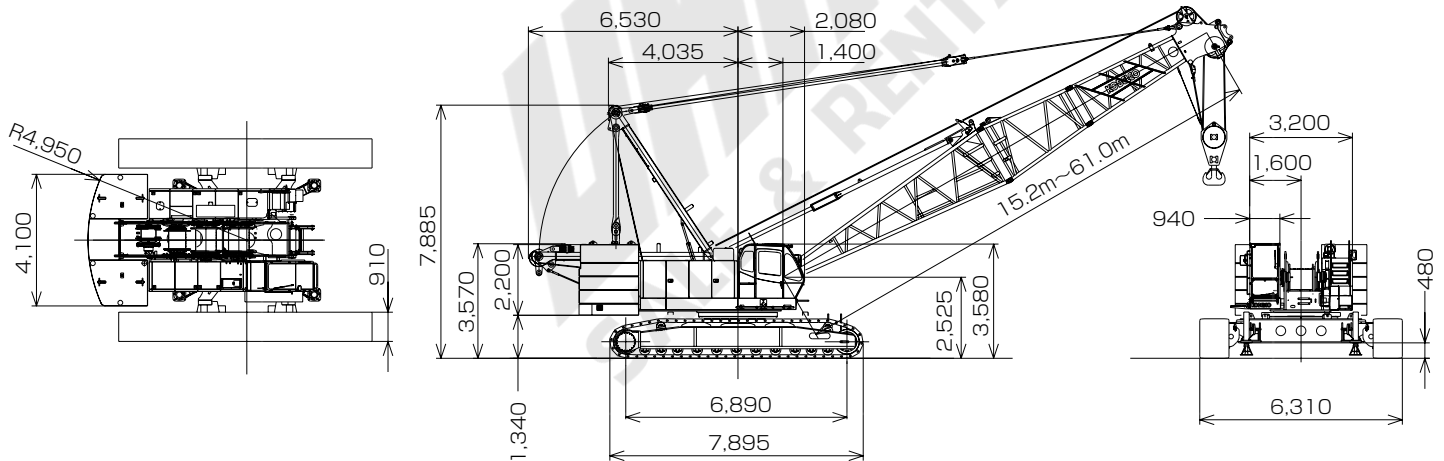

Note: This catalog may contain photographs of machines with specifications, attachments and optional equipment not certified for operation in your country. Please consult KOBELCO for those items you may require. Due to our policy of continual product improvements all designs and specifications are subject to change without advance notice.

Copyright by KOBELCO CRANES CO., LTD. No part of this catalog may be reproduced in any manner without notice.

KOBELCO CRANES CO., LTD.

17-1, Higashigotanda 2-chome, Shinagawa-ku, Tokyo, 141-8626 JAPAN
Tel: +81-3-5789-2130 Fax: +81-3-5789-3372

Inquiries To: