



HYDRAULIC CRAWLER CRANE

CKE1800

Model: CKE1800-1F



Max. Lifting Capacity: 180 ton x 3.75 m
Max. Crane Boom Length: 85.3 m
Max. Long Boom Length: 85.3 m
Max. Fixed Jib Combination: 73.2 m + 30.5 m
Max. Luffing Jib Combination: 54.9 m + 51.8 m



ASIAGROUP LEASING PTE LTD

NO.3 PIONEER PLACE SINGAPORE 627804 TEL:+65 67562288 FAX:+65 67568822

Email : asiagroup@asiacrane.com Website : www.asiacranes.com



ASIAGROUP LEASING PTE LTD

NO.3 PIONEER PLACE SINGAPORE 627804 TEL:+65 67562288 FAX:+65 67568822

Crane Boom

Max. Lifting Capacity:
160 metric ton x 4.4 m
Max. Boom Length:
85.3 m



Long Boom

Max. Lifting Capacity:
40.1 metric ton x 12.0 m
Max. Boom Length:
85.3 m



Heavy Duty Crane Boom

Max. Lifting Capacity:
180 metric ton x 3.75 m
Max. Boom Length:
12.2 m



Luffing Boom

Max. Lifting Capacity:
110 metric ton x 5.2 m
Max. Boom Length:
54.9 m





ASIAGROUP LEASING PTE LTD

NO.3 PIONEER PLACE SINGAPORE 627804 TEL:+65 67562288 FAX:+65 67568822

Fixed Jib

Max. Lifting Capacity:
26.8 metric ton x 15.2 m
Max. Combination:
73.2 m + 30.5 m



Luffing Jib

Max. Lifting Capacity:
48.6 metric ton x 9.14 m
Max. Combination:
54.9 m + 51.8 m



Luffing Boom with Luffing Jib

Max. Lifting Capacity:
71.5 metric ton x 9.0 m



CONTENTS

- Configuration 1
- Specifications 3
- General Dimensions 5
- Boom and Jib Arrangements**
- Crane Boom Arrangements 7
- Fixed Jib Arrangements 8
- Long Boom Arrangements 8
- Luffing Boom Arrangements for Luffing 9
- Luffing Boom Arrangements for Crane 9
- Luffing Jib Arrangements 10
- Working Ranges and Lifting Capacities**
- Crane Boom Working Ranges 12
- Crane Boom Lifting Capacity 13
- Luffing Boom Working Ranges 14
- Luffing Boom Lifting Capacity 15
- Long Boom Working Ranges 16
- Long Boom Lifting Capacity 17
- Fixed Jib Working Ranges 18
- Fixed Jib Lifting capacities 19
- Luffing Jib Working Ranges 21
- Luffing Jib Lifting Capacities 23
- Luffing Boom Lifting Capacities with Luffing Jib 30
- Parts and Attachments 31
- Transportation Plan 33





Power Plant

Model: Hino diesel engine P11C-UN
Type: Water-cooled, direct fuel injection, with turbocharger
 Complies with NRMM (Europe) Tier III and USA EPA Tier III
Displacement: 10.520 liters
Rated Power: 247 kW/ 2,000 min⁻¹ {rpm} (ISO)
Max. torque: 1,300 N-m/1,500 min⁻¹
Cooling system: Liquid, re-circulating bypass
Starter: 24V / 6.0 kW
Radiator: Corrugated type core, thermostatically controlled
Air cleaner: Dry type with replaceable paper element
Throttle: Electric throttle control, twist grip type
Fuel filter: Replaceable paper element.
Batteries: Two 12 V, 170 Ah/20 HR capacity batteries, series connected.
Fuel tank capacity: 400 liters



Hydraulic System

Four variable displacement piston pumps are driven by heavy-duty pump drive. Two of variable displacement pumps are used in the main hook hoist circuit, auxiliary hook hoist circuit, third hoist circuit and each propel circuit. One of the other two pumps is used in the boom hoist circuit, and the other is used in the swing circuit.

Control: Full-flow hydraulic control system for infinitely variable pressure to front and rear drums, boom hoist brakes and clutches. Controls respond instantly to the touch, delivering smooth function operation.

Cooling: Oil-to-air heat exchanger (plate-fin type)

Filtration: Full-flow and bypass type with replaceable element

Electrical system: All wiring corded for easy servicing, individual fused branch circuits.

Max. relief valve pressure:

Load hoist, boom hoist and propel system:

31.9 MPa {325 kgf/cm²}

Swing system: 27.5 MPa {280 kgf/cm²}

Control system: 7.0 MPa {71.3 kgf/cm²}

Reservoir capacity: 550 liters



Boom Hoisting System

Powered by a hydraulic motor through a planetary reducer.

Brake: A spring-set, hydraulically released multiple-disc brake is mounted on the boom hoist motor and operated through a counter-balance valve.

Drum lock: External ratchet for locking drum.

Drum: Double drum, grooved for 22 mm dia. wire rope.

Line speed: Double line on first drum layer
Hoisting/Lowering: 54 m/min

Diameter of wire ropes

Boom guy line: 30 mm

Boom hoist reeving: 16 parts of 22 mm dia. high strength wire rope

Boom backstops: Telescopic type with spring bumper
Required for all boom lengths



Load Hoist System

Front and rear drums for load hoist powered by a hydraulic variable plunger motors, driven through planetary reducers.

Negative Brake: A spring-set, hydraulically released multiple-disc brake is mounted on the hoist motor and operated through a counter-balance valve. (Positive free fall brake is optional item.)

Drum lock: External ratchet for locking drum

Drums:

Front drum:

617.4 mm P.C.D. x 833.7 mm Lg. wide drum, grooved for 25 mm wire rope. Rope capacity is 430 m working length and 510 m storage length.

Rear drum:

617.1 mm P.C.D. x 833.7 mm Lg. wide drum, grooved for 25 mm wire rope. Rope capacity is 335 m working length and 510 m storage length.

Note: Rope lengths listed above denote drum capacity and may differ from actual rope lengths supplied when machinery is shipped.

Line speed: Single line on the first drum layer

Hoisting/Lowering: 100 m/min

Line Pull (Single-line):

Rated line pull: 132 kN {13.5 tf}



Swing System

Swing unit is powered by hydraulic motor driving spur gears through planetary reducers (2 sets), the swing system provides 360° rotation.

Swing parking brakes: A spring-set, hydraulically released multiple-disc brake is mounted on swing motor.

Swing circle: Single-row ball bearing with an integral internally cut swing gear.

Swing lock: Manually, four position lock for transportation

Swing speed: 2.6 min⁻¹ {rpm}



Upper Structure

Torsion-free precision machined upper frame. All components are located clearly and service friendly. Engine with low noise level. Complies with European Noise Regulations.

Counterweight: 60.0 ton





ASIAGROUP LEASING PTE LTD

NO.3 PIONEER PLACE SINGAPORE 627804 TEL:+65 67562288 FAX:+65 67568822



Cab & Control

Totally enclosed, full vision cab with safety glass, fully adjustable, high backed seat with a head-rest and armrests, and intermittent wiper and window washer (skylight and front window).

Cab fittings:

Air conditioner, convenient compartment (for tool), cup holder, ashtray, cigarette lighter, sun visor, roof blind, tinted glass, floor mat, foot-rest, shoe tray

Controls:

Four adjustable levers for front drum, rear drum, boom drum and swing controls, and boom hoist pedal.



Lower Structure

Steel-welded carbody with axles. Crawler assemblies are designed with quick disconnect feature for individual removal as a unit from axles. Crawler belt tension is maintained by hydraulic jack force on the track-adjusting bearing block.

Carbody weight: 20.0 ton

Crawler drive: Independent hydraulic propel drive is built into each crawler side frame. Each drive consists of a hydraulic motor propelling a driving tumbler through a planetary gear box. Hydraulic motor and gear box are built into the crawler side frame within the shoe width.

Crawler brakes: Spring-set, hydraulically released parking brakes are built into each propel drive.

Steering mechanism: A hydraulic propel system provides both skid steering (driving one track only) and counter-rotating steering (driving each track in opposite directions).

Track rollers: Sealed track rollers for maintenance-free operation.

Shoes (flat): 64 shoes, 1,070 mm wide each crawler

Max. travel speed: 1.1/0.7 km/h

Max. gradeability: 30%



Weight

Including upper and lower machine, 60.0 ton counterweight and 20.0 ton carbody weight, basic boom (or basic boom + basic jib), hook, and other accessories.

Specification

Weight

Ground pressure

Crane boom Approx. 164 ton, 103 kPa {1.06 kgf/cm²}

Luffing jib Approx. 171.0 ton, 95.0 kPa {0.97 kgf/cm²}



Attachment

Boom and Jib:

Welded lattice construction using tubular, high-tensile steel chords with pin connections between sections.

Boom and Jib Length

	Min. Length (Min. Combination)	Max. Length (Max. Combination)
Crane Boom	15.2 m	85.3 m
Luffing Boom	15.2 m	54.9 m
Long Boom	61.0 m	85.3 m
Fixed Jib	24.4 m + 12.2 m	73.2 m + 30.5 m
Luffing Jib	21.3 m + 21.3 m	54.9 m + 51.8 m



Main Specifications (Model: CKE 1800-1F)

Heavy Duty Crane Boom	
Max. Lifting Capacity	180 t/3.75 m
Max. Length	12.2 m
Crane Boom	
Max. Lifting Capacity	160 t/4.4 m
Max. Length	85.3 m
Luffing Boom	
Max. Lifting Capacity	110 t/5.2 m
Max. Length	54.9 m
Long Boom	
Max. Lifting Capacity	40.1 t/12.0 m
Max. Length	85.3 m
Fixed Jib	
Max. Lifting Capacity	26.8 t/15.2 m
Max. Length	30.5 m
Max. Combination	73.2 m + 30.5 m
Luffing Jib	
Max. Lifting Capacity	48.6 t/9.14 m
Jib Length	21.3 m ~ 51.8 m
Max. Combination	54.9 m + 51.8 m
Luffing Angle	60° ~ 88°
Working Speed	
Swing Speed	2.6 min ⁻¹ {rpm}
Travel Speed	1.1/0.7 km/h

Power Plant	
Model	Hino P11C-UN
Engine Output	247 kW/2,000 min ⁻¹ {rpm}
Fuel Tank Capacity	400 liters
Main & Aux. Winch	
Max. Line Speed	100 m/min (1st layer)
Rated Line Pull	132 kN {13.5 tf}
Wire Rope Diameter	25 mm
Wire Rope Length	430 m (Main) 335 m (Aux.)
Brake Type	Spring set hydraulically released (Negative)
Free Fall Brake	Wet-type multiple disc brake (Optional)
Hydraulic System	
Pumps	4 variable displacement
Max. Pressure	31.9 MPa {325 kgf/cm ² }
Hydraulic Tank Capacity	550 liters
Self Erection Device	
Standard	
Weight	
Operating Weight*	Approx. 164 t
Ground Pressure*	103 kPa {1.06 kgf/cm ² }
Counterweight	60.0 t (Upper), 20.0 t (Lower)
Transportation Weight**	Approx. 44.0 t

* Including upper and lower machine, 60.0 ton counterweight, 20.0 ton carbody weight, basic boom, hook, and other accessories.

** Base machine with boom base, trans-lifter, main and aux. winches (non-freefall) including wire rope, self removal device.

Units are SI units. { } indicates conventional units.



Crane Boom

(Unit: mm)

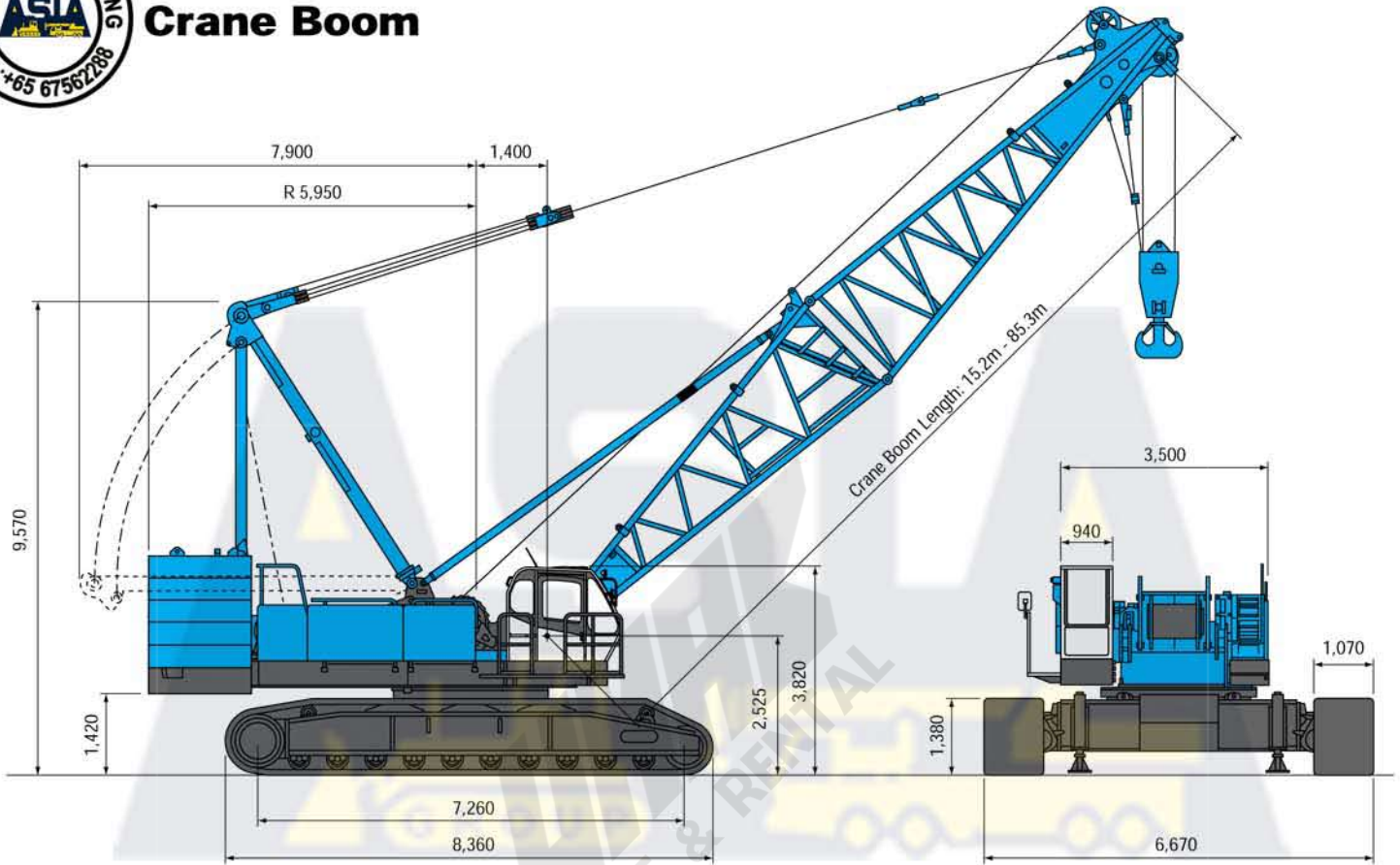

Limit of Hook Lifting

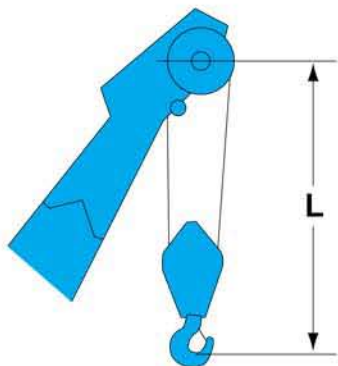

Hook	L
180 t/160 t hook	5.2 m
110 t hook	5.1 m
70 t hook	4.9 m
35 t hook	4.7 m

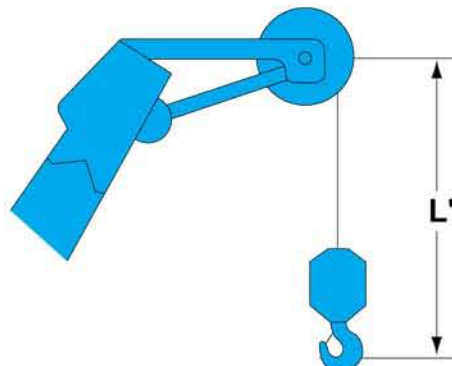

Hook	L'
13.5 t ball hook	3.5 m



ASIAGROUP LEASING PTE LTD

NO.3 PIONEER PLACE SINGAPORE 627804 TEL:+65 67562288 FAX:+65 67568822

Luffing Jib

(Unit: mm)

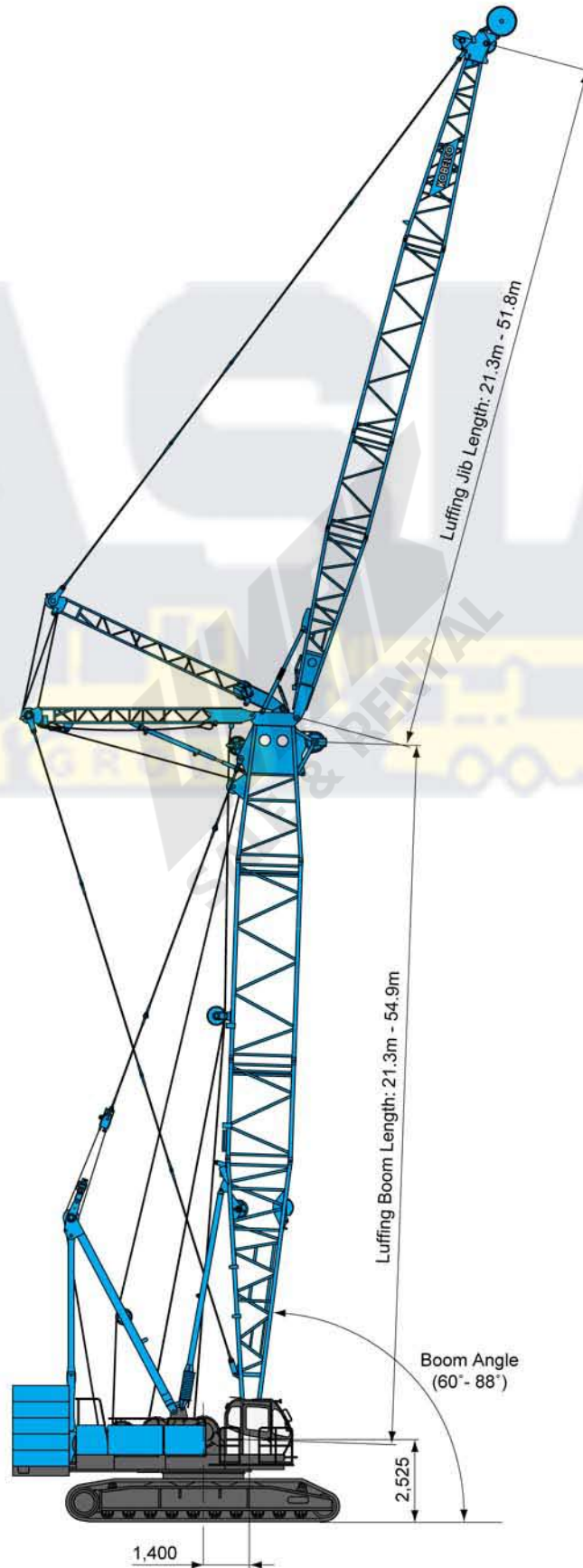



Crane Boom Arrangements

Boom length m (ft)	Boom arrangement
12.2 (40)	For Heavy Duty Crane Boom
15.2 (50)	
18.3 (60)	
21.3 (70)	
24.4 (80)	
27.4 (90)	
30.5 (100)	
33.5 (110)	
36.6 (120)	
39.6 (130)	
42.7 (140)	
45.7 (150)	
48.8 (160)	
51.8 (170)	
54.9 (180)	

Boom length m (ft)	Boom arrangement
57.9 (190)	
61.0 (200)	
64.0 (210)	
67.1 (220)	
70.1 (230)	
73.2 (240)	
76.2 (250)	
79.3 (260)	
82.3 (270)	
85.3 (280)	

Symbol	Boom Length	Remarks
	8.5 m	Boom Base
	3.7 m	Heavy Duty Crane Boom Top
	6.7 m	Boom Top
	3.0 m	Insert Boom
	6.1 m	Insert Boom
	9.1 m	Insert Boom
	12.2 m	Insert Boom

↗ mark shows the guy line installing position when the fixed jib is used.

※ Indicates the most flexible combination of insert booms, which can be modified to form all shorter boom arrangements.





ASIAGROUP LEASING PTE LTD

NO.3 PIONEER PLACE SINGAPORE 627804 TEL:+65 67562288 FAX:+65 67568822

Fixed Jib Arrangements

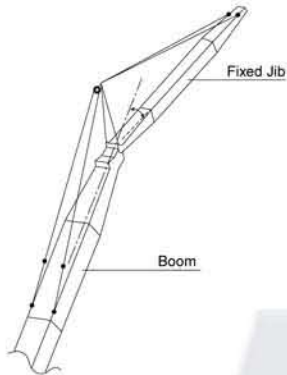

Crane boom length	Jib length m (ft)	Jib arrangement
24.4 m 73.2 m	12.2 (40)	
	18.3 (60)	
	24.4 (80)	
	30.5 (100)	



Symbol	Jib Length	Remarks
	4.6 m	Jib Base
	4.6 m	Jib Top
	3.0 m	Insert Jib
	6.1 m	Insert Jib

Long Boom Arrangements

Boom length m (ft)	Long Boom arrangement
61.0 (200)	
64.0 (210)	
67.1 (220)	
70.1 (230)	
73.2 (240)	
76.2 (250)	
79.3 (260)	
82.3 (270)	
85.3 (280)	



Symbol	Long Boom Length	Remarks
	8.5 m	Boom Base
	6.4 m	Luffing Jib Top
	3.0 m	Insert Boom
	6.1 m	Insert Boom
	9.1 m	Insert Boom
	3.6 m	Tapered Boom
	3.0 m	Luffing Insert Jib
	6.1 m	Luffing Insert Jib
	9.1 m	Luffing Insert Jib

※ Indicates the most flexible combination of insert long booms, which can be modified to form all shorter long boom arrangements.



Luffing Boom Arrangements for Luffing

Boom length m (ft)	Boom arrangement	Boom length m (ft)	Boom arrangement
21.3 (70)		39.6 (130)	
24.4 (80)		42.7 (140)	
27.4 (90)		45.7 (150)	
30.5 (100)		48.8 (160)	
33.5 (110)		51.8 (170)	
36.6 (120)		54.9 (180)	



Symbol	Luffing Boom Length	Remarks
	8.5 m	Boom Base
	3.7 m	Luffing Boom Top
	3.0 m	Insert Boom
	6.1 m	Insert Boom
	9.1 m	Insert Boom

※ Indicates the most flexible combination of insert luffing booms, which can be modified to form all shorter luffing boom arrangements.

Luffing Boom Arrangements for Crane

Boom length m (ft)	Boom arrangement	Boom length m (ft)	Boom arrangement
15.2 (50)		36.6 (120)	
18.3 (60)		39.6 (130)	
21.3 (70)		42.7 (140)	
24.4 (80)		45.7 (150)	
27.4 (90)		48.8 (160)	
30.5 (100)		51.8 (170)	
33.5 (110)		54.9 (180)	



Symbol	Luffing Boom Length	Remarks
	8.5 m	Boom Base
	3.7 m	Luffing Boom Top
	3.0 m	Insert Boom
	6.1 m	Insert Boom
	9.1 m	Insert Boom

※ Indicates the most flexible combination of insert luffing booms, which can be modified to form all shorter luffing boom arrangements.



Luffing Jib Arrangements

Jib length m (ft)	Jib arrangement
21.3 (70)	
24.4 (80)	
27.4 (90)	
30.5 (100)	
33.5 (110)	

Jib length m (ft)	Jib arrangement
36.6 (120)	
39.6 (130)	
42.7 (140)	
45.7 (150)	
48.8 (160)	
51.8 (170)	

Symbol	Luffing Jib Length	Remarks
	5.8 m	Luffing Jib Base
	6.4 m	Luffing Jib Top
	3.0 m	Luffing Insert Jib
	6.1 m	Luffing Insert Jib
	9.1 m	Luffing Insert Jib

※ Indicates the most flexible combination of insert luffing jibs, which can be modified to form all shorter luffing jib arrangements.

Luffing Boom and Jib Combinations.

		Jib Length (m)										
		21.3	24.4	27.4	30.5	33.5	36.6	39.6	42.7	45.7	48.8	51.8
Boom Length (m)	21.3	<input type="checkbox"/>	<input type="checkbox"/>	<input type="checkbox"/>	<input type="checkbox"/>	<input type="checkbox"/>	<input type="checkbox"/>	<input type="checkbox"/>	<input type="checkbox"/>	<input type="checkbox"/>	<input type="checkbox"/>	<input type="checkbox"/>
	24.4	<input type="checkbox"/>	<input type="checkbox"/>	<input type="checkbox"/>	<input type="checkbox"/>	<input type="checkbox"/>	<input type="checkbox"/>	<input type="checkbox"/>	<input type="checkbox"/>	<input type="checkbox"/>	<input type="checkbox"/>	<input type="checkbox"/>
	27.4	<input type="checkbox"/>	<input type="checkbox"/>	<input type="checkbox"/>	<input type="checkbox"/>	<input type="checkbox"/>	<input type="checkbox"/>	<input type="checkbox"/>	<input type="checkbox"/>	<input type="checkbox"/>	<input type="checkbox"/>	<input type="checkbox"/>
	30.5	<input type="checkbox"/>	<input type="checkbox"/>	<input type="checkbox"/>	<input type="checkbox"/>	<input type="checkbox"/>	<input type="checkbox"/>	<input type="checkbox"/>	<input type="checkbox"/>	<input type="checkbox"/>	<input type="checkbox"/>	<input type="checkbox"/>
	33.5	<input type="checkbox"/>	<input type="checkbox"/>	<input type="checkbox"/>	<input type="checkbox"/>	<input type="checkbox"/>	<input type="checkbox"/>	<input type="checkbox"/>	<input type="checkbox"/>	<input type="checkbox"/>	<input type="checkbox"/>	<input type="checkbox"/>
	36.6	<input type="checkbox"/>	<input type="checkbox"/>	<input type="checkbox"/>	<input type="checkbox"/>	<input type="checkbox"/>	<input type="checkbox"/>	<input type="checkbox"/>	<input type="checkbox"/>	<input type="checkbox"/>	<input type="checkbox"/>	<input type="checkbox"/>
	39.6	<input type="checkbox"/>	<input type="checkbox"/>	<input type="checkbox"/>	<input type="checkbox"/>	<input type="checkbox"/>	<input type="checkbox"/>	<input type="checkbox"/>	<input type="checkbox"/>	<input type="checkbox"/>	<input type="checkbox"/>	<input type="checkbox"/>
	42.7	<input type="checkbox"/>	<input type="checkbox"/>	<input type="checkbox"/>	<input type="checkbox"/>	<input type="checkbox"/>	<input type="checkbox"/>	<input type="checkbox"/>	<input type="checkbox"/>	<input type="checkbox"/>	<input type="checkbox"/>	<input type="checkbox"/>
	45.7	<input type="checkbox"/>	<input type="checkbox"/>	<input type="checkbox"/>	<input type="checkbox"/>	<input type="checkbox"/>	<input type="checkbox"/>	<input type="checkbox"/>	<input type="checkbox"/>	<input type="checkbox"/>	<input type="checkbox"/>	<input type="checkbox"/>
	48.8	<input type="checkbox"/>	<input type="checkbox"/>	<input type="checkbox"/>	<input type="checkbox"/>	<input type="checkbox"/>	<input type="checkbox"/>	<input type="checkbox"/>	<input type="checkbox"/>	<input type="checkbox"/>	<input type="checkbox"/>	<input type="checkbox"/>
	51.8	<input type="checkbox"/>	<input type="checkbox"/>	<input type="checkbox"/>	<input type="checkbox"/>	<input type="checkbox"/>	<input type="checkbox"/>	<input type="checkbox"/>	<input type="checkbox"/>	<input type="checkbox"/>	<input type="checkbox"/>	<input type="checkbox"/>
54.9	<input type="checkbox"/>	<input type="checkbox"/>	<input type="checkbox"/>	<input type="checkbox"/>	<input type="checkbox"/>	<input type="checkbox"/>	<input type="checkbox"/>	<input type="checkbox"/>	<input type="checkbox"/>	<input type="checkbox"/>	<input type="checkbox"/>	

○ : Combinations which is allowed





ASIAGROUP LEASING PTE LTD

NO.3 PIONEER PLACE SINGAPORE 627804 TEL:+65 67562288 FAX:+65 67568822



Hook Blocks

A range of hook blocks can be specified, each with a safety latch.

Hooks	Weight (kg)	No. of sheaves	No. of lines and max. rated loads (tons)					
			1	2	3	4	5	6
180/160-ton	2,800	8	-	26.8	40.1	53.5	66.9	80.3
110-ton	1,800	4	-	26.8	40.1	53.5	66.9	80.3
70-ton	1,200	3	-	26.8	40.1	53.5	66.9	70.0
35-ton	900	1	-	26.8	35.0	-	-	-
13.5-ton ball hook	460	0	13.5	-	-	-	-	-

Hooks	Weight (kg)	No. of sheaves	No. of lines and max. rated loads (tons)					
			7	8	9	10	12	14
180/160-ton	2,800	8	93.7	107.0	120.4	133.8	160.0	180.0
110-ton	1,800	4	93.7	107.0	110.0	-	-	-
70-ton	1,200	3	-	-	-	-	-	-
35-ton	900	1	-	-	-	-	-	-
13.5-ton ball hook	460	0	-	-	-	-	-	-



Main Hoist Drum Rated Loads in Metric Tons

No. of Parts of Line	1	2	3	4	5	6
Max. Loads (ton)	13.5	26.8	40.1	53.5	66.9	80.3
No. of Parts of Line	7	8	9	10	12	14
Max. Loads (ton)	93.7	107.0	120.4	133.8	160.0	180.0

Symbols for Attachments:



Crane Boom Auxiliary Sheave for Crane Boom Luffing Boom Aux. Sheave for Luffing Boom Long Boom Aux. Sheave for Long Boom Fixed Jib Luffing Jib Luffing Boom with Luffing Jib



Crane Boom Working Ranges

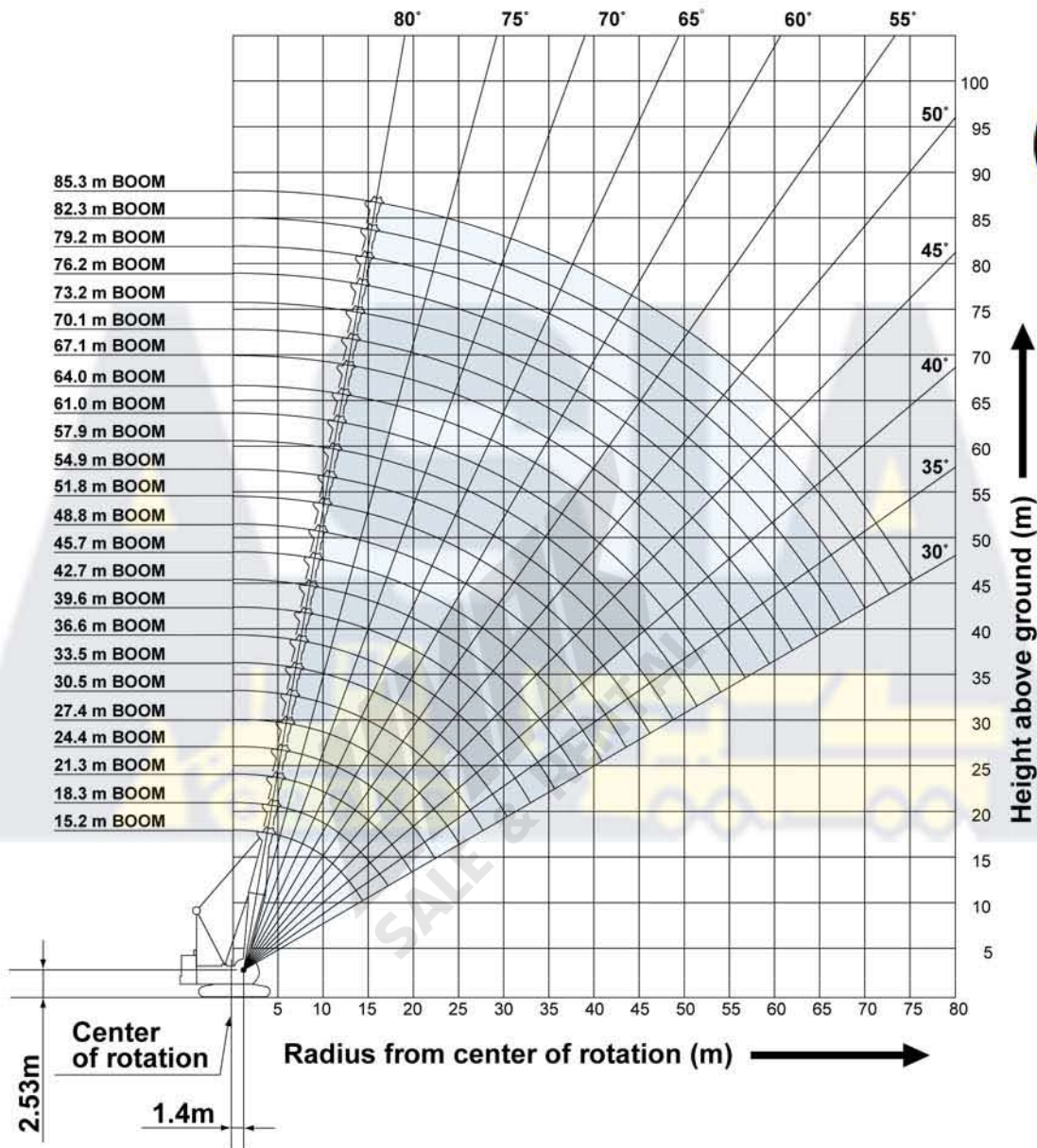

NOTES:

1. Ratings according to EN13000.
2. Ratings in metric tons for 360° working area.
3. Operating radius is the horizontal distance from center of rotation to a vertical line through the center of gravity of the load.
4. Deduct weight of hook block(s), slings and all other load handling accessories from main boom or auxiliary sheave ratings shown.
5. Ratings shown are based on freely suspended loads and make no allowance for such factors as wind effect on lifted load, ground conditions out-of-level, operating speeds or any other condition that could be detrimental to the safe operation of this equipment. Operator, therefore, has the responsibility to judge the existing conditions and reduce lifted loads and operating speeds accordingly.
6. Ratings are for operation on a firm and level surface, up to 1% gradient.
7. At radii and boom lengths where no ratings are shown on chart, operation is not intended nor approved.
8. Boom inserts and guy lines must be arranged as shown in the "Operator's Manual".
9. Boom hoist reeving is 16 part line.
10. Gantry must be in raised position for all conditions.
11. Boom backstops are required for all boom lengths.
12. The boom should be erected over the front of crawlers, not laterally.
13. Ratings shown in are determined by the strength of the boom or other structural component.
14. Instruction in the "Operator's Manual" must be strictly observed when operating the machine.
15. Crane boom ratings: Deduct weight of hook block(s), slings, and all other load handling accessories from crane boom ratings shown.
16. Auxiliary sheave ratings: Deduct 0.6 ton (weight of auxiliary sheave frame), weight of hook block(s), slings and all other load handling accessories from crane boom ratings shown, but should not exceed 26.8 tons.
Crane boom lengths for auxiliary sheave mounting are 15.2 m to 82.3 m.
17. Crane boom ratings with auxiliary sheave: Deduct 0.6 ton, weight of hook block(s), slings and all other load handling accessories from crane boom ratings shown. Minimum ratings is 1.6 tons.
18. Heavy duty crane boom ratings: Deduct weight of hook block(s), slings and all other load handling accessories from crane boom ratings shown.



ASIAGROUP LEASING PTE LTD

NO.3 PIONEER PLACE SINGAPORE 627804 TEL:+65 67562288 FAX:+65 67568822

Crane Boom Lifting Capacity

Unit: metric ton

Counterweight: 60.0 t, Carbody weight: 20.0 t

Working radius (m)	Boom Length (m)														Working radius (m)	
	12.2*	15.2	18.3	21.3	24.4	27.4	30.5	33.5	36.6	39.6	42.7	45.7	48.8	51.8		
3.0	3.75m/180.0															3.0
4.0	171.5	4.4m/160.0	4.9m/144.2													4.0
5.0	140.5	141.6	141.6	5.4m/131.4	5.9m/121.3											5.0
6.0	119.1	119.3	119.3	119.3	119.3	6.4m/112.0	6.9m/103.9									6.0
7.0	102.0	102.7	102.7	102.7	102.7	102.7	102.5	7.4m/97.1	7.9m/90.6							7.0
8.0	88.1	89.5	89.5	89.5	89.5	89.5	89.5	89.5	89.5	8.4m/80.3	8.9m/76.8					8.0
9.0	76.8	79.0	79.0	79.0	79.0	79.0	79.0	79.0	79.0	78.4	76.3	9.4m/70.6				9.0
10.0	67.7	71.5	71.5	71.5	71.5	71.5	71.5	71.5	71.5	70.2	68.4	66.6	10.0m/65.4	10.5m/60.7		10.0
12.0	51.4	58.8	58.7	58.6	58.5	58.4	58.3	58.2	58.2	57.8	56.5	55.1	54.0	52.8		12.0
14.0	12.4m/50.0	47.2	47.7	47.6	47.4	47.3	47.2	47.0	47.0	46.9	46.7	46.5	46.0	45.0		14.0
16.0		14.8m/41.9	40.2	40.1	39.9	39.8	39.6	39.4	39.4	39.3	39.1	38.9	38.8	38.6		16.0
18.0			17.5m/35.9	34.4	34.2	34.1	34.0	33.7	33.7	33.6	33.3	33.2	33.1	32.9		18.0
20.0				30.1	29.8	29.6	29.5	29.3	29.2	29.1	28.9	28.7	28.6	28.4		20.0
22.0				20.1m/29.9	26.5	26.3	26.2	25.9	25.8	25.7	25.5	25.3	25.3	25.0		22.0
24.0					22.7m/25.4	23.6	23.4	23.2	23.0	22.9	22.7	22.5	22.4	22.2		24.0
26.0						25.4m/22.0	21.1	20.9	20.7	20.6	20.4	20.2	20.1	19.9		26.0
28.0							28.0m/19.2	19.0	18.8	18.7	18.5	18.3	18.2	18.0		28.0
30.0								17.4	17.2	17.1	16.9	16.7	16.6	16.4		30.0
32.0								30.7m/16.9	15.8	15.7	15.4	15.2	15.1	14.9		32.0
34.0									33.3m/15.0	14.4	14.2	14.0	13.9	13.6		34.0
36.0										35.9m/13.4	13.1	13.0	12.8	12.6		36.0
38.0											12.2	12.1	11.8	11.7		38.0
40.0											38.6m/12.0	11.1	11.0	10.7		40.0
42.0												41.2m/10.7	10.3	10.0		42.0
44.0													43.8m/9.7	9.4		44.0
46.0														8.7		46.0
48.0														46.5m/8.6		48.0
Reeves	14	12	12	10	10	9	8	8	7	6	6	6	5	5	Reeves	

* Values of 12.2 m boom length are lifting capacities for heavy duty crane boom.

Working radius (m)	Boom Length (m)												Working radius (m)	
	54.9	57.9	61.0	64.0	67.1	70.1	73.2	76.2	79.2	82.3	85.3			
10.0	11.0m/56.4	11.5m/52.4												10.0
12.0	51.5	50.5	12.0m/48.3	12.5m/44.7	13.0m/41.2	13.5m/38.0								12.0
14.0	43.9	43.2	42.3	41.5	40.1	37.5	14.0m/34.5	14.5m/31.8	15.0m/29.0	15.5m/25.9				14.0
16.0	38.1	37.5	36.7	36.1	35.3	34.8	32.2	30.1	27.9	25.3	16.1m/21.0			16.0
18.0	32.7	32.7	32.3	31.8	31.1	30.7	29.8	27.8	25.9	22.9	19.0			18.0
20.0	28.3	28.2	28.0	27.9	27.7	27.3	26.7	25.8	23.9	20.9	17.2			20.0
22.0	24.9	24.8	24.6	24.5	24.4	24.2	24.0	23.6	22.0	19.1	15.6			22.0
24.0	22.1	22.0	21.9	21.7	21.6	21.4	21.4	21.3	20.3	17.5	14.2			24.0
26.0	19.7	19.7	19.4	19.4	19.2	19.0	19.0	18.9	18.7	16.0	13.0			26.0
28.0	17.8	17.7	17.5	17.5	17.3	17.1	17.0	17.0	16.8	14.7	11.8			28.0
30.0	16.2	16.1	15.9	15.8	15.6	15.5	15.4	15.3	15.2	13.5	10.8			30.0
32.0	14.7	14.6	14.4	14.3	14.2	14.0	13.9	13.8	13.7	12.4	9.9			32.0
34.0	13.5	13.4	13.2	13.1	12.9	12.8	12.7	12.6	12.4	11.4	9.0			34.0
36.0	12.4	12.3	12.1	12.0	11.9	11.7	11.6	11.5	11.3	10.4	8.2			36.0
38.0	11.4	11.3	11.2	11.1	10.9	10.8	10.7	10.5	10.3	9.6	7.4			38.0
40.0	10.6	10.4	10.2	10.2	10.0	9.8	9.7	9.6	9.4	8.7	6.7			40.0
42.0	9.9	9.7	9.5	9.4	9.3	9.1	9.0	8.9	8.7	8.0	6.0			42.0
44.0	9.2	9.0	8.9	8.8	8.5	8.4	8.3	8.2	8.0	7.3	5.4			44.0
46.0	8.5	8.4	8.2	8.1	7.9	7.7	7.6	7.5	7.4	6.6	4.8			46.0
48.0	8.0	7.9	7.6	7.6	7.4	7.2	7.1	7.0	6.8	6.0	4.2			48.0
50.0	49.1m/7.7	7.4	7.1	7.0	6.9	6.7	6.6	6.5	6.3	5.4	3.7			50.0
52.0		51.8m/6.9	6.7	6.6	6.4	6.2	6.0	5.9	5.8	4.8	3.2			52.0
54.0			6.2	6.2	6.0	5.7	5.6	5.5	5.3	4.3	2.7			54.0
56.0			54.4m/6.1	5.8	5.5	5.3	5.2	5.0	4.8	3.8	2.2			56.0
58.0				57.0m/5.5	5.1	4.9	4.7	4.6	4.4	3.3	1.8			58.0
60.0					59.7m/4.8	4.5	4.4	4.2	4.0	2.8	59.0m/1.6			60.0
62.0						4.2	4.0	3.9	3.7	2.4				62.0
64.0						62.3m/4.1	3.7	3.6	3.3	1.9				64.0
66.0							65.0m/3.5	3.2	2.9	65.0m/1.7				66.0
68.0								67.6m/3.0	2.4					68.0
70.0									70.0m/2.0					70.0
reeves	5	4	4	4	4	3	3	3	3	2	2	reeves		

Note: Ratings according to EN13000.

Ratings shown in are determined by the strength of the boom or other structural components.

Refer to notes P12.



Luffing Boom Working Ranges

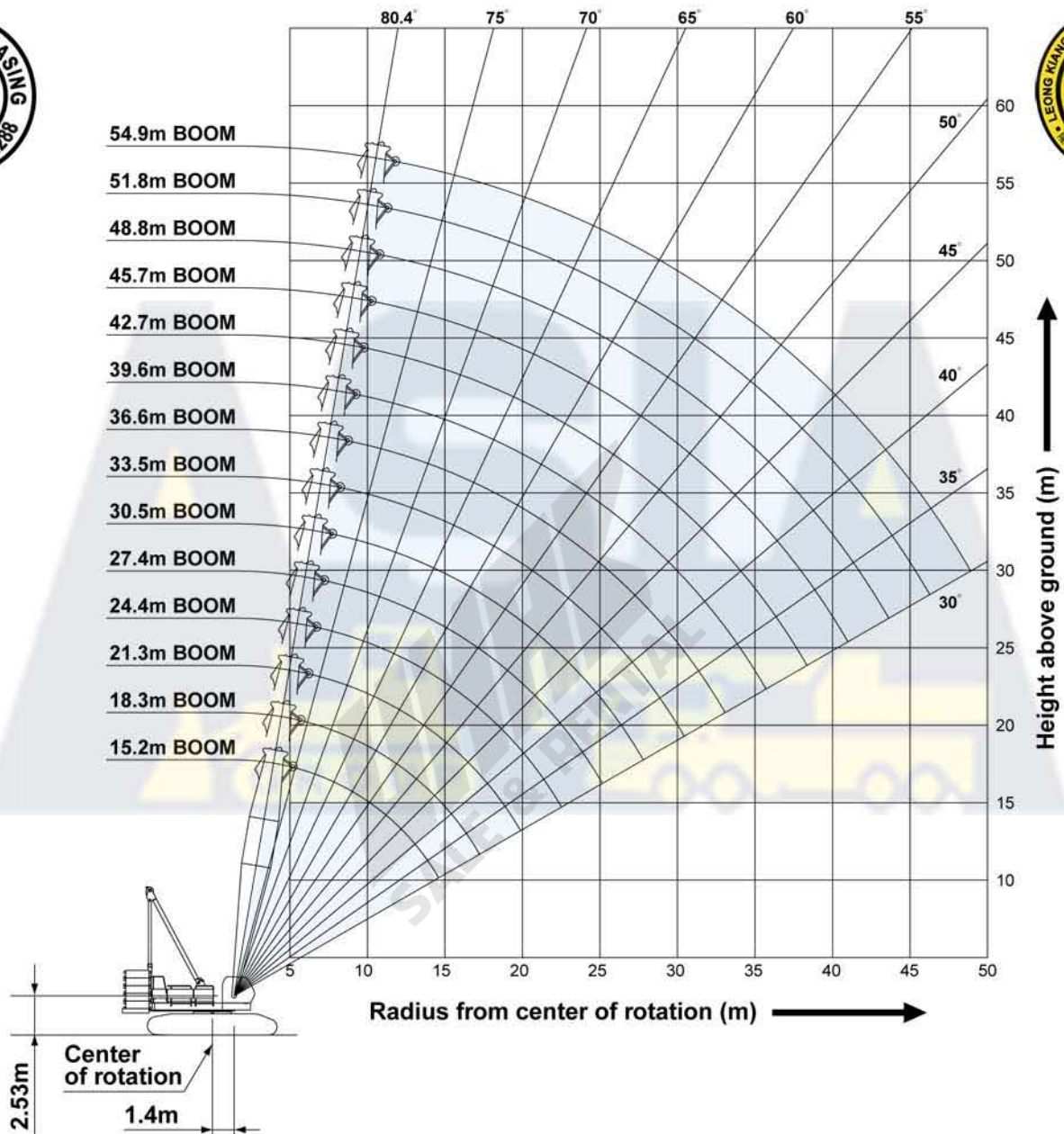

NOTES:

- Ratings according to EN13000.
- Ratings in metric tons for 360° working area.
- Operating radius is the horizontal distance from center of rotation to a vertical line through the center of gravity of the load.
- Deduct weight of hook block(s), slings and all other load handling accessories from long boom or jib ratings shown.
- Ratings shown are based on freely suspended loads and make no allowance for such factors as wind effect on lifted load, ground conditions out-of-level, operating speeds or any other condition that could be detrimental to the safe operation of this equipment. Operator, therefore, has the responsibility to judge the existing conditions and reduce lifted loads and operating speeds accordingly.
- Ratings are for operation on a firm and level surface, up to 1% gradient.
- At radii and boom lengths where no ratings are shown on chart, operation is not intended nor approved.
- Boom/ jib inserts and guy lines must be arranged as shown in the "Operator's Manual".
- Boom hoist reeving is 16 part line.
- Gantry must be in raised position for all conditions.
- Boom backstops are required for all boom lengths.
- The boom should be erected over the front of crawlers, not laterally.
- Ratings shown in are determined by the strength of the boom or other structural component.
- Instruction in the "Operator's Manual" must be strictly observed when operating the machine.
- Luffing boom ratings: Deduct weight of hook block(s), slings and all other load handling accessories from luffing boom ratings shown.
- Auxiliary sheave ratings: Deduct 0.6 ton (weight of auxiliary sheave frame), weight of hook block(s), slings and all other load handling accessories from luffing boom ratings shown, but should not exceed 26.8 tons.
Luffing boom lengths for auxiliary sheave mounting are 15.2 m to 54.9 m.
- Luffing boom ratings with auxiliary sheave: Deduct 0.6 ton, weight of hook block(s), slings and all other load handling accessories from luffing boom ratings shown.



ASIAGROUP LEASING PTE LTD

NO.3 PIONEER PLACE SINGAPORE 627804 TEL:+65 67562288 FAX:+65 67568822

Luffing Boom Lifting Capacity

Unit: metric ton

Counterweight: 60.0 t, Carbody weight: 20.0 t

Working radius (m)	Boom Length (m)															Working radius (m)
	15.2	18.3	21.3	24.4	27.4	30.5	33.5	36.6	39.6	42.7	45.7	48.8	51.8	54.9		
5.0	5.2m /110.0	5.7m /107.0														5.0
6.0	107.0	106.7	6.2m /106.2	6.8m /103.7												6.0
7.0	101.3	101.2	101.1	101.0	7.3m /96.8	7.8m /90.4										7.0
8.0	89.8	89.7	89.6	89.5	89.4	89.3	8.3m /85.5	8.8m /80.3								8.0
9.0	79.4	79.3	79.3	79.1	79.0	79.0	78.8	78.7	9.3m /75.5	9.8m /69.3						9.0
10.0	71.2	71.1	71.0	70.9	70.8	70.7	70.6	70.5	69.4	67.5	10.3m /64.0	10.8m /59.3	11.3m /55.1	11.8m /51.3		10.0
12.0	57.5	57.3	57.2	57.0	56.9	56.8	56.6	56.6	56.5	55.5	54.2	52.9	51.6	50.4		12.0
14.0	46.2	46.4	46.3	46.1	46.0	45.9	45.7	45.7	45.6	45.4	45.2	44.8	43.7	42.7		14.0
16.0	15.2m /39.2	39.0	38.9	38.6	38.5	38.4	38.2	38.1	38.0	37.8	37.7	37.6	37.4	36.9		16.0
18.0		17.8m /33.6	33.2	32.9	32.8	32.7	32.5	32.4	32.3	32.1	32.0	31.9	31.7	31.5		18.0
20.0			29.2	28.7	28.6	28.4	28.2	28.1	28.0	27.8	27.7	27.6	27.4	27.2		20.0
22.0			20.5m /28.0	25.3	25.2	25.1	24.8	24.7	24.6	24.4	24.2	24.2	24.0	23.8		22.0
24.0				23.1m /23.7	22.5	22.3	22.1	22.0	21.9	21.6	21.5	21.4	21.2	21.0		24.0
26.0					25.7m /20.4	20.1	19.8	19.7	19.6	19.3	19.2	19.1	18.9	18.7		26.0
28.0						18.2	17.9	17.8	17.7	17.5	17.3	17.2	17.0	16.8		28.0
30.0						28.4m /17.8	16.3	16.2	16.1	15.8	15.7	15.6	15.4	15.2		30.0
32.0							31.0m /15.6	14.8	14.7	14.4	14.3	14.2	13.9	13.8		32.0
34.0								33.7m /13.8	13.5	13.3	13.1	13.0	12.7	12.6		34.0
36.0									12.5	12.2	12.0	11.9	11.7	11.5		36.0
38.0									36.3m /12.3	11.2	11.0	10.9	10.7	10.5		38.0
40.0										38.9m /10.9	10.3	10.2	9.9	9.7		40.0
42.0											41.6m /9.7	9.4	9.1	9.0		42.0
44.0												8.8	8.5	8.3		44.0
46.0												44.2m /8.6	7.8	7.7		46.0
48.0													46.9m /7.6	7.1		48.0
50.0														49.5m /6.7		50.0
Reeves	8	8	8	8	8	7	7	6	6	6	5	5	5	4	Reeves	

Note: Ratings according to EN13000.

Ratings shown in are determined by the strength of the boom or other structural components.

Refer to notes P14.





Long Boom Working Ranges

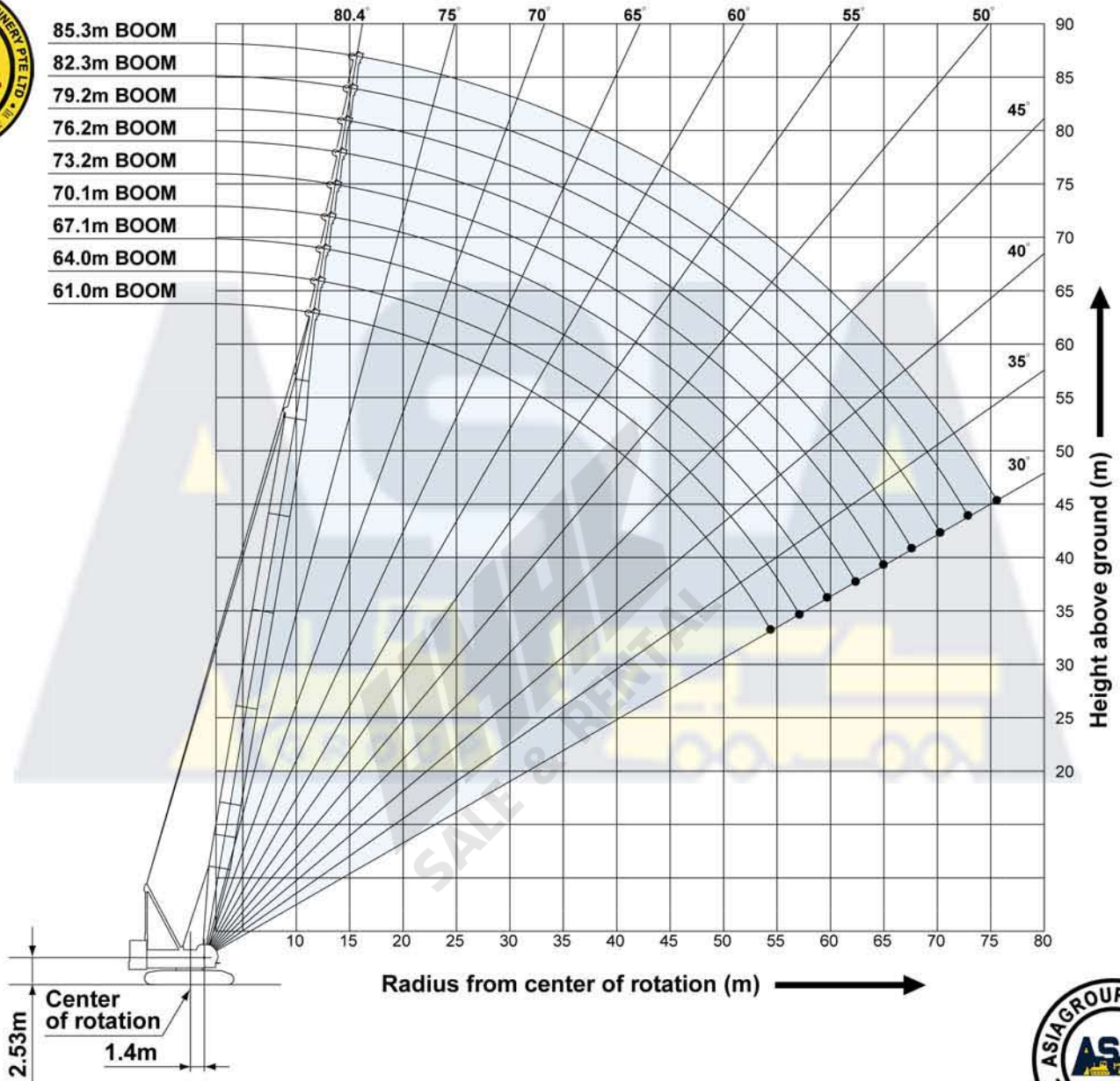

NOTES:

1. Ratings according to EN13000.
2. Ratings in metric tons for 360° working area.
3. Operating radius is the horizontal distance from center of rotation to a vertical line through the center of gravity of the load.
4. Deduct weight of hook block(s), slings and all other load handling accessories from long boom or jib ratings shown.
5. Ratings shown are based on freely suspended loads and make no allowance for such factors as wind effect on lifted load, ground conditions out-of-level, operating speeds or any other condition that could be detrimental to the safe operation of this equipment. Operator, therefore, has the responsibility to judge the existing conditions and reduce lifted loads and operating speeds accordingly.
6. Ratings are for operation on a firm and level surface, up to 1% gradient.
7. At radii and boom lengths where no ratings are shown on chart, operation is not intended nor approved.
8. Boom/ jib inserts and guy lines must be arranged as shown in the "Operator's Manual".
9. Boom hoist reeving is 16 part line.
10. Gantry must be in raised position for all conditions.
11. Boom backstops are required for all boom lengths.
12. Ratings shown in are determined by the strength of the boom or other structural component.
13. Instruction in the "Operator's Manual" must be strictly observed when operating the machine.
14. Long boom ratings: Deduct weight of hook block(s), slings and all other load handling accessories from long boom ratings shown.
15. Auxiliary sheave ratings: Deduct 0.4 ton (weight of auxiliary sheave frame), weight of hook block(s), slings and all other load handling accessories from long boom ratings shown, but should not exceed 13.5 tons. Long boom length for auxiliary sheave mounting are 61.0 m to 79.2 m.



ASIAGROUP LEASING PTE LTD

NO.3 PIONEER PLACE SINGAPORE 627804 TEL:+65 67562288 FAX:+65 67568822

Long Boom Lifting Capacity

Unit: metric ton

Counterweight: 60.0 t,
Carbody weight: 20.0 t

Working radius (m)	Boom Length (m)												Boom Length (m)	
	61.0	64.0	67.1	70.1	73.2	76.2	79.2	82.3	85.3	Working radius (m)	Working radius (m)			
10.0	11.9m/40.1											10.0		
12.0	40.1	12.4m/37.8	12.9m/35.0	13.4m/33.2	13.9m/31.6							12.0		
14.0	37.2	35.8	34.5	32.8	31.5	14.4m/27.9	14.9m/23.9	15.5m/20.7				14.0		
16.0	34.1	33.1	32.1	30.6	29.5	26.5	23.2	20.4	20.3			16.0		
18.0	31.0	30.3	29.6	28.4	27.5	24.9	21.9	19.4	19.3			18.0		
20.0	27.9	27.4	27.1	26.2	25.5	23.3	20.6	18.4	18.3			20.0		
22.0	24.9	24.7	24.5	24.0	23.5	21.7	19.5	17.4	17.3			22.0		
24.0	22.1	22.0	21.9	21.8	21.5	20.1	18.3	16.4	16.4			24.0		
26.0	19.8	19.7	19.6	19.6	19.5	18.5	17.1	15.5	15.5			26.0		
28.0	17.9	17.8	17.7	17.6	17.5	17.0	16.0	14.7	14.7			28.0		
30.0	16.3	16.2	16.1	16.0	15.9	15.5	14.9	13.9	13.9			30.0		
32.0	14.9	14.8	14.6	14.6	14.5	14.1	13.7	13.0	13.0			32.0		
34.0	13.6	13.5	13.4	13.4	13.2	12.9	12.8	12.3	12.3			34.0		
36.0	12.6	12.5	12.3	12.3	12.2	11.9	11.8	11.5	11.5			36.0		
38.0	11.6	11.5	11.4	11.3	11.2	10.9	10.9	10.8	10.8			38.0		
40.0	10.8	10.7	10.5	10.5	10.4	10.1	10.0	10.0	10.0			40.0		
42.0	10.0	9.9	9.8	9.7	9.6	9.4	9.3	9.3	9.3			42.0		
44.0	9.3	9.2	9.1	9.0	8.9	8.7	8.6	8.6	8.6			44.0		
46.0	8.7	8.6	8.5	8.4	8.3	8.1	8.0	8.0	8.0			46.0		
48.0	8.2	8.0	7.9	7.9	7.7	7.5	7.4	7.4	7.4			48.0		
50.0	7.7	7.5	7.4	7.3	7.2	7.0	6.9	6.9	6.9			50.0		
52.0	7.2	7.1	6.9	6.9	6.7	6.5	6.5	6.5	6.5			52.0		
54.0	6.8	6.6	6.5	6.4	6.3	6.1	6.0	6.0	6.0			54.0		
56.0	54.5m/16.7	6.3	6.1	6.1	5.9	5.7	5.7	5.7	5.6			56.0		
58.0		57.2m/16.0	5.8	5.7	5.6	5.4	5.3	5.3	5.2			58.0		
60.0			59.8m/15.5	5.4	5.2	5.0	5.0	5.0	4.8			60.0		
62.0				5.0	4.9	4.7	4.6	4.6	4.4			62.0		
64.0				62.4m/15.0	4.6	4.4	4.4	4.3	4.1			64.0		
66.0					65.1m/14.5	4.2	4.1	4.0	3.8			66.0		
68.0						67.7m/13.9	3.8	3.7	3.5			68.0		
70.0							3.5	3.5	3.2			70.0		
72.0								70.4m/13.4	3.2	3.0		72.0		
74.0									73.0m/13.1	2.8		74.0		
76.0										75.6m/12.6		76.0		
reeves	3	3	3	3	3	3	2	2	2			reeves		

Note: Ratings according to EN13000.

Ratings shown in are determined by the strength of the boom or other structural components. Refer to notes P16.



Fixed Jib Working Ranges

Jib Offset Angle: 10°, 30°

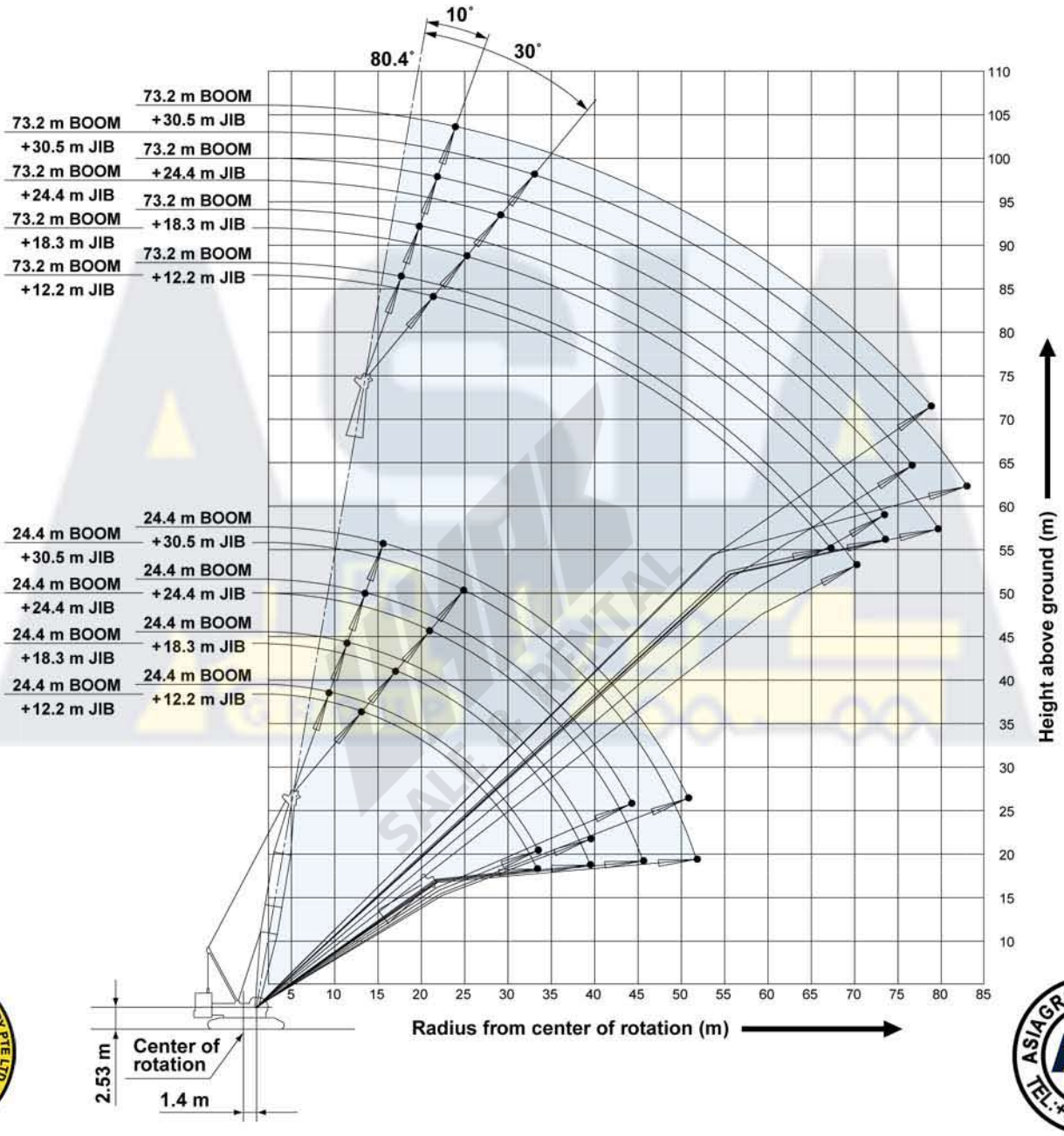

NOTES:

1. Ratings according to EN 13000.
2. Ratings in metric tons for 360° working area.
3. Operating radius is the horizontal distance from center of rotation to a vertical line through the center of gravity of the load.
4. Deduct weight of hook block (s), slings and all other load handling accessories from fixed jib ratings shown.
5. Ratings shown are based on freely suspended loads and make no allowance for such factors as wind effect on lifted load, ground conditions out-of-level, operating speeds or any other condition that could be detrimental to the safe operation of this equipment. Operator, therefore, has the responsibility to judge the existing conditions and reduce lifted loads and operating speeds accordingly.
6. Ratings are for operation on a firm and level surface, up to 1% gradient.
7. At radii and boom lengths where no ratings are shown on chart, operation is not intended nor approved.
8. Boom inserts and guy lines must be arranged as shown in the "Operator's Manual".
9. Boom hoist reeving is 16 part line.
10. Gantry must be in raised position for all conditions.
11. Boom backstops are required for all boom lengths.
12. Ratings shown in are determined by the strength of the boom or other structural component.
13. The boom should be erected over the front of the crawlers not laterally.
14. Instruction in the "Operator's Manual" must be strictly observed when operating the machine.
15. Fixed jib ratings: Deduct weight of hook block (s), slings, and all other load handling accessories from jib ratings shown.
16. Boom lengths for jib mounting are 24.4 m to 73.2 m.
17. One part of line on hook is not allowed to use for 12.2 m jib length with offset angle 10 degrees.



ASIAGROUP LEASING PTE LTD

NO.3 PIONEER PLACE SINGAPORE 627804 TEL:+65 67562288 FAX:+65 67568822

Fixed Jib Lifting Capacities (Without Main Hook)

Unit: metric ton

Jib Offset Angle: 10°

Counterweight: 60.0 t, Carbody weight: 20.0 t

Boom length (m)		24.4				33.5				42.7				51.8				Boom length (m)		
Jib length (m)		12.2	18.3	24.4	30.5	12.2	18.3	24.4	30.5	12.2	18.3	24.4	30.5	12.2	18.3	24.4	30.5	Jib length (m)		
Working radius (m)	9.0	9.8m/26.8																	9.0	
	10.0	26.8	11.0m/19.5			11.0m/26.8													10.0	
	12.0	26.5	19.3	12.8m/10.1		26.3	12.8m/19.4			12.2m/26.8									12.0	
	14.0	23.1	18.9	9.9	14.0m/6.1	24.3	19.1	14.6m/10.1		26.0	14.6m/19.3			14.0m/26.8					14.0	
	16.0	20.7	18.1	9.7	5.9	22.8	18.7	9.9	16.8m/6.0	24.6	19.1	16.8m/10.0		26.0	16.8m/19.2				16.0	
	18.0	19.2	17.5	9.5	5.8	21.4	18.2	9.7	5.9	23.2	18.6	9.9	18.3m/6.0	24.6	18.9	18.3m/9.9	19.8m/6.0		18.0	
	20.0	18.0	16.2	9.3	5.6	20.1	17.6	9.5	5.8	21.9	18.1	9.7	5.9	23.4	18.5	9.8	6.0		20.0	
	22.0	16.9	14.3	8.8	5.3	19.1	16.7	9.3	5.6	20.8	17.7	9.5	5.8	22.3	18.1	9.7	5.9		22.0	
	24.0	16.0	13.2	8.4	5.0	18.1	15.4	9.0	5.4	19.8	17.2	9.4	5.7	21.3	17.8	9.5	5.8		24.0	
	26.0	15.2	12.2	8.1	4.8	17.1	14.3	8.7	5.2	18.9	16.1	9.2	5.5	20.0	17.4	9.4	5.6		26.0	
	28.0	14.4	11.3	7.8	4.6	16.4	13.3	8.3	4.9	18.0	15.1	8.8	5.3	18.1	16.7	9.3	5.5		28.0	
	30.0	13.7	10.6	7.4	4.4	15.7	12.5	8.0	4.7	16.8	14.2	8.6	5.0	16.4	15.7	9.0	5.3		30.0	
	34.0	33.5m/12.7	9.4	6.9	4.0	14.5	11.1	7.5	4.4	14.2	12.6	8.0	4.7	13.7	13.9	8.5	4.9		34.0	
	38.0		8.4	6.5	3.7	12.7	10.0	7.1	4.0	12.2	11.4	7.6	4.4	11.6	11.8	8.0	4.6		38.0	
	42.0		39.6m/8.2	6.2	3.4	39.6m/12.0	9.1	6.7	3.8	10.5	10.4	7.2	4.1	9.9	10.2	7.6	4.4		42.0	
	46.0			44.2m/6.1	3.2		45.7m/8.4	6.4	3.5	9.2	9.4	6.8	3.9	8.6	8.8	7.3	4.1		46.0	
	50.0				3.0			6.1	3.3	48.8m/8.4	8.3	6.5	3.6	7.5	7.7	6.9	3.9		50.0	
	54.0				50.3m/3.0			51.8m/6.1	3.2			7.3	6.3	3.4	6.5	6.8	6.7	3.7		54.0
	58.0								57.9m/3.0			54.9m/7.1	6.1	3.3	57.9m/5.8	5.9	6.2	3.5		58.0
	62.0												61.0m/6.0	3.1		61.0m/5.4	5.5	3.4		62.0
66.0													3.0			4.9	3.2		66.0	
70.0														67.1m/3.0		67.1m/4.7	3.1		70.0	
74.0																	73.2m/3.0		74.0	
Reeves	2	2	1	1	2	2	1	1	2	2	1	1	2	2	1	1	Reeves			

Boom length (m)		61.0				70.1				73.2				Boom length (m)	
Jib length (m)		12.2	18.3	24.4	30.5	12.2	18.3	24.4	30.5	12.2	18.3	24.4	30.5	Jib length (m)	
Working radius (m)	16.0	16.8m/26.6				16.8m/21.7									16.0
	18.0	25.9	18.3m/19.1	19.8m/9.9		21.4	19.8m/19.1			18.3m/19.1	19.8m/18.7				18.0
	20.0	24.7	18.8	9.9	21.3m/6.0	21.0	19.1	21.3m/9.9		18.8	18.7	21.3m/9.9			20.0
	22.0	23.6	18.5	9.8	5.9	20.6	18.7	9.9	22.9m/5.9	18.4	18.3	9.9	22.9m/6.0		22.0
	24.0	21.8	18.1	9.7	5.9	20.2	18.4	9.8	5.9	18.0	17.9	9.8	5.9		24.0
	26.0	19.6	17.8	9.5	5.7	19.1	18.1	9.7	5.8	17.6	17.5	9.7	5.8		26.0
	28.0	17.6	17.3	9.4	5.6	17.1	17.4	9.5	5.7	16.9	16.9	9.5	5.7		28.0
	30.0	15.9	16.1	9.3	5.5	15.4	15.7	9.4	5.6	15.2	15.6	9.4	5.6		30.0
	34.0	13.2	13.4	8.8	5.2	12.7	13.0	9.2	5.4	12.5	12.8	9.2	5.4		34.0
	38.0	11.1	11.3	8.4	4.9	10.6	10.9	8.7	5.1	10.4	10.7	8.8	5.2		38.0
	42.0	9.4	9.7	8.0	4.6	8.9	9.2	8.3	4.8	8.8	9.0	8.4	4.9		42.0
	46.0	8.0	8.3	7.6	4.4	7.6	7.8	7.9	4.6	7.3	7.6	8.0	4.6		46.0
	50.0	6.9	7.2	7.3	4.1	6.5	6.7	7.1	4.3	6.3	6.5	6.8	4.4		50.0
	54.0	6.0	6.2	6.5	3.9	5.5	5.8	6.1	4.1	5.3	5.5	5.9	4.2		54.0
	58.0	5.2	5.4	5.7	3.7	4.6	4.9	5.3	3.9	4.4	4.6	5.1	4.0		58.0
	62.0	4.4	4.7	5.0	3.5	3.8	4.1	4.5	3.8	3.5	3.8	4.2	3.8		62.0
	66.0	64.0m/4.1	4.0	4.4	3.4	3.1	3.4	3.8	3.6	2.8	3.0	3.5	3.6		66.0
	70.0		3.4	3.7	3.3	2.4	2.7	3.1	3.3	2.1	2.4	2.8	2.9		70.0
	74.0		70.1m/3.4	3.1	3.2	73.2m/2.0	2.1	2.5	2.7	70.1m/2.1	73.2m/2.0	2.3	2.4		74.0
	78.0			76.2m/2.9	2.8		76.2m/1.9	2.0	2.2			76.2m/2.0	77.7m/2.0		78.0
82.0				2.3			79.2m/1.9	80.8m/1.9						82.0	
86.0				82.3m/2.3										86.0	
Reeves	2	2	1	1	2	2	1	1	2	2	1	1	Reeves		

Note: Ratings according to EN13000.

Ratings shown in are determined by the strength of the boom or other structural components.

Refer to notes P18.

※ One part of line on hook is not allowed to use for 12.2 m jib length with offset angle 10 degrees.





ASIAGROUP LEASING PTE LTD

NO.3 PIONEER PLACE SINGAPORE 627804 TEL:+65 67562288 FAX:+65 67568822

Unit: metric ton

Jib Offset Angle: 30°

Counterweight: 60.0 t, Carbody weight: 20.0 t

Boom length (m)		24.4				33.5				42.7				51.8				Boom length (m)			
Jib length (m)		12.2	18.3	24.4	30.5	12.2	18.3	24.4	30.5	12.2	18.3	24.4	30.5	12.2	18.3	24.4	30.5	Jib length (m)			
Working radius (m)	12.0	13.4m/17.2																12.0			
	14.0	17.2				14.6m/17.2												14.0			
	16.0	16.0	16.8m/12.8							16.8m/17.1								16.0			
	18.0	15.2	12.2			16.1	18.3m/12.8			16.7	19.8m/12.8				18.3m/17.1			18.0			
	20.0	14.3	11.2	21.3m/7.5		15.6	12.1			16.1	12.8				16.6	21.3m/12.8		20.0			
	22.0	13.5	10.5	7.4		14.8	11.4	22.9m/7.5		15.7	12.1			16.2	12.6			22.0			
	24.0	12.7	9.8	7.2	24.4m/4.1		14.1	10.8	7.4	25.9m/4.1		15.2	11.4	24.4m/7.5		15.8	12.0	25.9m/7.5		24.0	
	26.0	12.1	9.3	7.0	4.0	13.4	10.2	7.2	4.1	14.5	10.9	7.4	27.4m/4.1		15.3	11.5	7.5		26.0		
	28.0	11.6	8.8	6.8	3.9	12.8	9.7	7.0	4.0	13.9	10.4	7.2	4.1	14.8	11.0	7.4	29.0m/4.1		28.0		
	30.0	11.2	8.3	6.5	3.7	12.3	9.2	6.8	3.9	13.4	9.9	7.1	4.0	14.2	10.5	7.2	4.0		30.0		
	34.0	33.5m/10.6		7.6	5.9	3.4	11.5	8.4	6.4	3.6	12.5	9.1	6.8	3.8	13.3	9.8	6.9	3.9	34.0		
	38.0		7.1	5.4	3.3	36.6m/11.1		7.8	5.9	3.4	11.7	8.5	6.4	3.5	11.9	9.1	6.7	3.7	38.0		
	42.0		39.6m/7.0		5.0	3.1		7.4	5.5	3.3	10.7	8.0	5.9	3.4	10.2	8.6	6.3	3.5	42.0		
	46.0			45.7m/4.8		3.0		42.7m/7.3		5.2	3.1	45.7m/9.4		7.5	5.6	3.3	8.8	8.1	5.9	3.4	46.0
	50.0				2.9			48.8m/5.0		3.0			7.2	5.3	3.1	7.6	7.7	5.6	3.2	50.0	
	54.0				51.8m/2.9					2.9		51.8m/7.1		5.0	3.0	51.8m/7.2		7.1	5.4	3.2	54.0
	58.0								54.9m/2.9				57.9m/4.9		2.9		57.9m/6.2		5.1	3.0	58.0
	62.0													2.9				4.9	3.0	62.0	
	66.0													64.0m/2.9				64.0m/4.9		2.9	66.0
	70.0																		2.9	70.0	
74.0																		70.1m/2.9		74.0	
Reeves	2	1	1	1	2	1	1	1	2	1	1	1	2	1	1	1	1	1	Reeves		

Boom length (m)		61.0				70.1				73.2				Boom length (m)			
Jib length (m)		12.2	18.3	24.4	30.5	12.2	18.3	24.4	30.5	12.2	18.3	24.4	30.5	Jib length (m)			
Working radius (m)	18.0	19.8m/17.1													18.0		
	20.0	17.0				21.3m/17.1				21.3m/17.2					20.0		
	22.0	16.6	22.9m/12.8							17.1					22.0		
	24.0	16.2	12.5			16.6	24.4m/13.2			16.7	25.9m/12.9				24.0		
	26.0	15.9	12.0	27.4m/7.5		16.2	12.8			16.4	12.9				26.0		
	28.0	15.5	11.5	7.5		15.9	12.3	29.0m/7.5		16.0	12.4	29.0m/7.6			28.0		
	30.0	15.0	11.0	7.3	30.5m/4.1		15.6	11.8	7.5	32.0m/4.1		15.6	12.0	7.5	32.0m/4.1		30.0
	34.0	13.6	10.3	7.1	3.9	13.2	11.1	7.2	4.0	13.1	11.2	7.3	4.0		34.0		
	38.0	11.4	9.6	6.8	3.8	11.1	10.4	7.0	3.8	10.9	10.5	7.0	3.9		38.0		
	42.0	9.7	9.1	6.6	3.6	9.3	9.8	6.8	3.7	9.1	9.8	6.8	3.7		42.0		
	46.0	8.3	8.6	6.3	3.4	7.9	8.5	6.6	3.5	7.7	8.3	6.7	3.6		46.0		
	50.0	7.1	7.6	5.9	3.4	6.7	7.3	6.4	3.4	6.5	7.1	6.5	3.4		50.0		
	54.0	6.2	6.6	5.7	3.3	5.8	6.3	6.1	3.4	5.6	6.1	6.2	3.4		54.0		
	58.0	57.9m/5.3		5.8	5.4	3.1	4.9	5.4	5.7	3.2	4.6	5.2	5.6	3.3	58.0		
	62.0		5.0	5.2	3.0	4.0	4.6	4.9	3.1	3.7	4.4	4.8	3.2	62.0			
	66.0		64.0m/4.7		4.6	3.0	3.2	3.8	4.2	3.1	2.9	3.6	4.0	3.1	66.0		
	70.0			4.0	2.9	67.1m/3.0		3.1	3.5	3.0	67.1m/2.8		2.9	3.3	3.0	70.0	
	74.0			70.1m/4.0		2.9		73.2m/2.6		2.9	2.9	73.2m/2.4		2.6	2.9	74.0	
	78.0				76.2m/2.9				2.3	2.6			2.0	2.4	78.0		
	82.0							79.2m/2.1		2.0		79.2m/1.9		1.8	82.0		
84.0								83.8m/1.8				82.3m/1.8		84.0			
Reeves	2	1	1	1	2	1	1	1	2	1	1	1	1	Reeves			

Note: Ratings according to EN13000.

Ratings shown in [] are determined by the strength of the boom or other structural components. Refer to notes P18.





Luffing Jib Working Ranges

Boom Angle: 88°

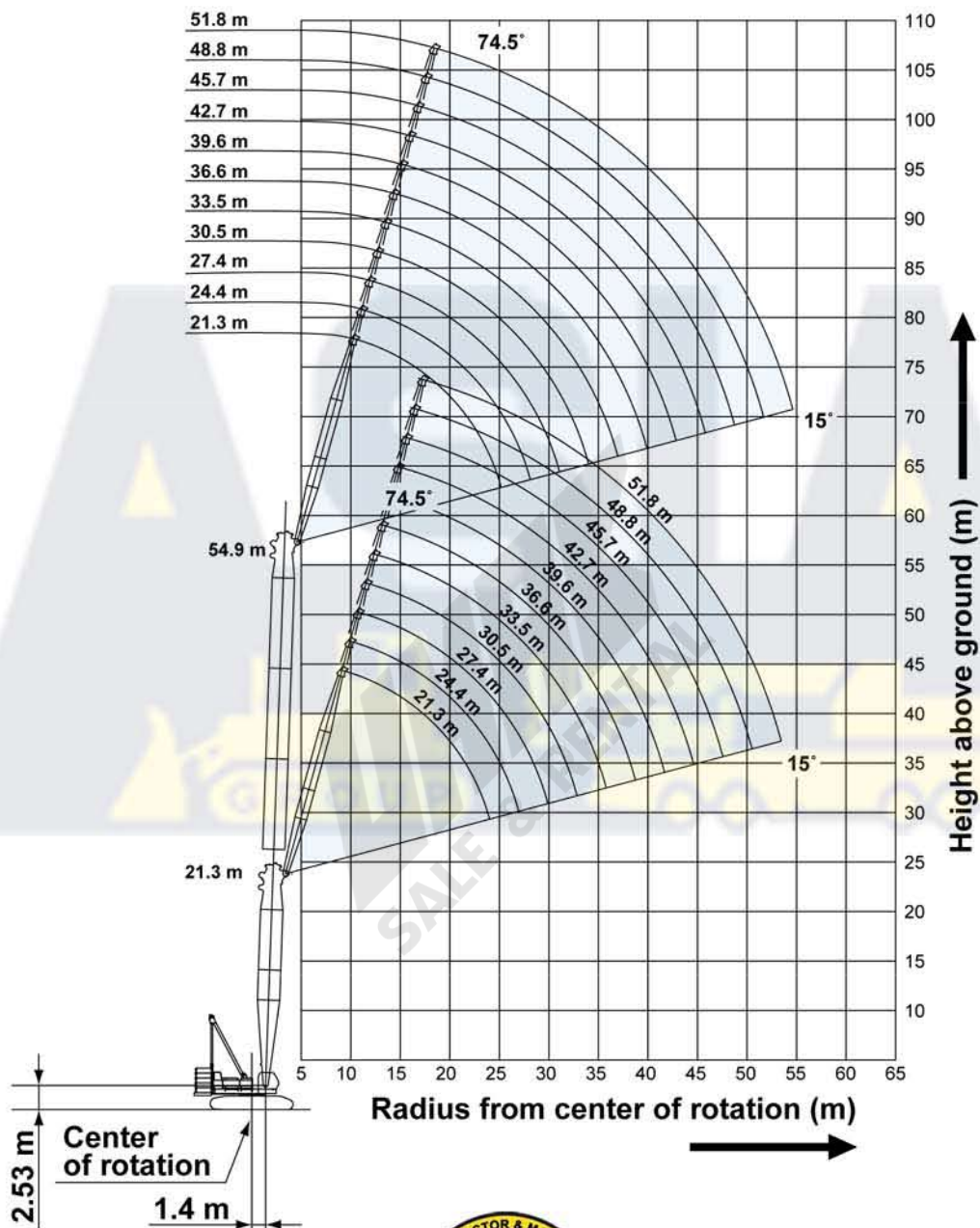

NOTES:

1. Ratings according to EN13000.
2. Ratings in metric tons for 360° working area.
3. Operating radius is the horizontal distance from center of rotation to a vertical line through the center of gravity of the load.
4. Deduct weight of hook block(s), slings and all other load handling accessories from luffing jib ratings or main boom ratings with luffing jib shown.
5. Ratings shown are based on freely suspended loads and make no allowance for such factors as wind effect on lifted load, ground conditions out-of-level, operating speeds or any other condition that could be detrimental to the safe operation of this equipment. Operator, therefore, has the responsibility to judge the existing conditions and reduce lifted loads and operating speeds accordingly.
6. Ratings are for operation on a firm and level surface, up to 1% gradient.
7. At radii and boom lengths where no ratings are shown on chart, operation is not intended nor approved.
8. Boom/jib inserts and guy lines must be arranged as shown in the "Operator's Manual".
9. Luffing boom hoist reeving is 16 part line.
10. Jib hoist reeving is 8 part line.

Boom Angle: 60°

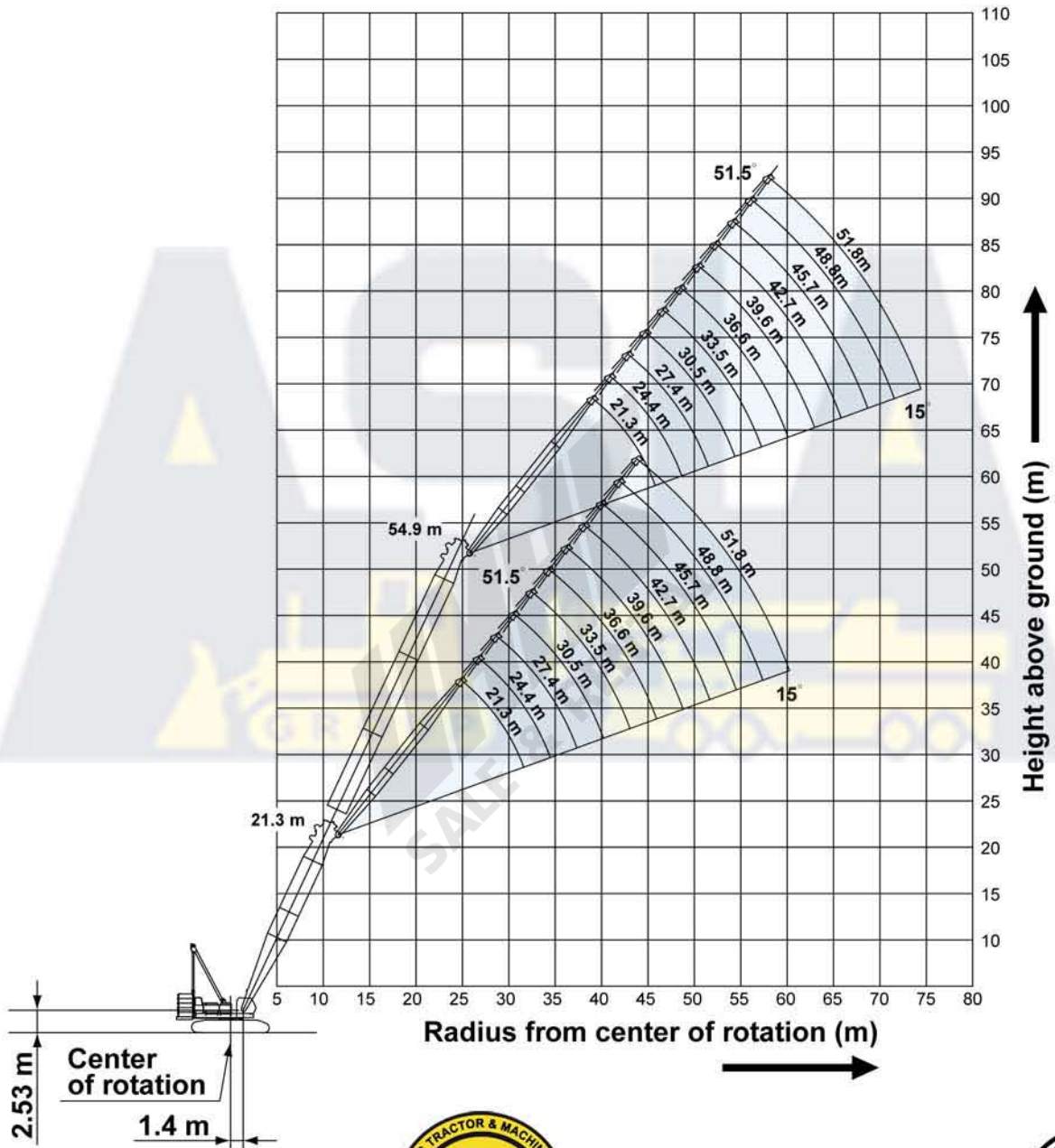

11. Gantry must be in raised position for all conditions.
12. Boom and jib backstops are required for all boom and jib combinations.
13. Ratings shown in are determined by the strength of the boom or other structural component.
14. The boom should be erected over the front of crawlers, not laterally.
15. When erecting and lowering the all boom and jib combinations, the pillow plate for erection must be placed at the end of crawlers.
16. Instruction in the "Operator's Manual" must be strictly observed when operating the machine.
17. The minimum rated load is 2.0 tons.
18. Luffing jib ratings: Deduct weight of hook block(s), slings, and all other load handling accessories from luffing jib ratings shown.
19. Main boom ratings with luffing jib: Deduct weight of hook block(s), slings, and all other load handling accessories from main boom ratings with luffing jib shown.



Luffing Jib Lifting Capacities (Without Main Hook)

Unit: metric ton

Counterweight: 60.0 t, Carbody weight: 20.0 t

21.3 m Boom Length	21.3																	Boom length (m)
	21.3				27.4				33.5				39.6				Jib length (m)	
	88°	83°	65°	60°	88°	83°	65°	60°	88°	83°	65°	60°	88°	83°	65°	60°	Boom angle	
9.14	48.6																9.14	
10.0	48.3																10.0	
12.0	47.7				47.4												12.0	
14.0	43.3	47.4			43.2			42.9				34.6					14.0	
16.0	35.8	40.9			35.7	40.7		35.4				33.5					16.0	
18.0	30.4	35.1			30.2	34.9		30.0	34.7			29.7					18.0	
20.0	26.2	30.2			26.2	30.1		25.9	30.3			25.6	30.0				20.0	
22.0	23.0	26.1			22.9	26.0		22.7	26.1			22.4	25.9				22.0	
24.0		22.9			20.4	22.8		20.1	22.9			19.9	22.7				24.0	
26.0			20.3		18.2	20.3		18.0	20.3			17.7	20.1				26.0	
28.0			18.6		16.5	18.2		16.2	18.2			16.0	17.9				28.0	
30.0			17.1	16.7		16.4	16.7	14.7	16.4			14.5	16.2				30.0	
34.0				32.0m/15.4			14.3	13.8	32.0m/13.4	13.6	13.9		12.1	13.4			34.0	
38.0							36.0m/13.3	12.1		36.0m/12.5	12.2	11.7	10.3	11.2	11.8		38.0	
42.0											10.7	10.5		9.6	10.5	10.0	42.0	
46.0												44.0m/9.8			9.3	9.0	46.0	
50.0															46.0m/8.8	8.1	50.0	
Reeves		4				4			4				3				Reeves	

21.3 m Boom Length	21.3								Boom length (m)
	45.7				51.8				Jib length (m)
	88°	83°	65°	60°	88°	83°	65°	60°	Boom angle
18.0	22.9							18.0	
20.0	21.2				16.3			20.0	
22.0	19.8	21.5			15.1			22.0	
24.0	18.4	19.7			14.1			24.0	
26.0	17.3	18.4			13.0	14.0		26.0	
28.0	15.9	17.3			12.3	13.1		28.0	
30.0	14.4	16.2			11.5	12.3		30.0	
34.0	12.0	13.3			10.2	10.8		34.0	
38.0	10.1	11.2			9.1	9.6		38.0	
42.0	8.6	9.5	10.0		8.2	8.6		42.0	
46.0	44.0m/8.0	8.2	9.1	8.5	7.3	7.7	8.7	46.0	
50.0		48.0m/7.6	8.1	7.8	6.3	6.8	7.8	52.0m/7.1	50.0
54.0			7.2	7.0		52.0m/6.3	6.9	6.6	54.0
58.0				56.0m/6.6			58.0m/6.2	6.0	58.0
62.0								5.4	62.0
Reeves		2				2			Reeves

Note: Ratings according to EN13000.
Ratings shown in [] are determined by the strength of the boom or other structural components. Refer to notes P21 and P22.





ASIAGROUP LEASING PTE LTD

NO.3 PIONEER PLACE SINGAPORE 627804 TEL:+65 67562288 FAX:+65 67568822

27.4 m Boom Length	27.4																Working radius (m)																	
	21.3				27.4				33.5				39.6																					
	88°	83°	65°	60°	88°	83°	65°	60°	88°	83°	65°	60°	88°	83°	65°	60°																		
Working radius (m)	10.0	12.0	14.0	16.0	18.0	20.0	22.0	24.0	26.0	28.0	30.0	34.0	38.0	42.0	46.0	50.0	54.0	10.0	12.0	14.0	16.0	18.0	20.0	22.0	24.0	26.0	28.0	30.0	34.0	38.0	42.0	46.0	50.0	54.0
Reeves	4				4				4				3				Reeves																	

Note: Ratings according to EN13000.
Ratings shown in are determined by the strength of the boom or other structural components. Refer to notes P21 and P22.

27.4 m Boom Length	27.4								Working radius (m)																							
	45.7				51.8																											
	88°	83°	65°	60°	88°	83°	65°	60°																								
Working radius (m)	18.0	20.0	22.0	24.0	26.0	28.0	30.0	34.0	38.0	42.0	46.0	50.0	54.0	58.0	62.0	66.0	18.0	20.0	22.0	24.0	26.0	28.0	30.0	34.0	38.0	42.0	46.0	50.0	54.0	58.0	62.0	66.0
Reeves	2				2				Reeves																							





ASIAGROUP LEASING PTE LTD

NO.3 PIONEER PLACE SINGAPORE 627804 TEL:+65 67562288 FAX:+65 67568822

Unit: metric ton

Counterweight: 60.0 t, Carbody weight: 20.0 t

33.5 m Boom Length	33.5																Boom length (m)
	21.3				27.4				33.5				39.6				Jib length (m)
	88°	83°	65°	60°	88°	83°	65°	60°	88°	83°	65°	60°	88°	83°	65°	60°	Boom angle
10.0	47.4																10.0
12.0	47.4				47.4												12.0
14.0	45.7	47.4			45.6				42.6								14.0
16.0	37.5	40.2			37.5				37.2				33.0				16.0
18.0	31.6	34.4			31.6	34.2			31.4				31.3				18.0
20.0	27.2	30.1			27.2	30.0			26.9	29.6			27.2				20.0
22.0	23.7	26.6			23.7	26.5			23.5	26.3			23.7	25.9			22.0
24.0		23.9			21.0	23.8			20.8	23.5			20.9	23.4			24.0
26.0		21.5			18.7	21.5			18.5	21.2			18.6	21.1			26.0
28.0					16.8	19.5			16.7	19.3			16.7	19.2			28.0
30.0			32.0m/14.4			17.9			15.1	17.7			15.1	17.6			30.0
34.0			13.3	36.0m/11.9			36.0m/12.2		32.0m/13.7	14.6			12.6	14.4			34.0
38.0				11.1			11.3	40.0m/9.8		36.0m/13.3		10.7	10.6	12.1			38.0
42.0							40.0m/10.6	9.5				9.7	44.0m/8.3	10.2	44.0m/8.8		42.0
46.0								44.0m/8.9				8.5	8.1		8.3	48.0m/7.0	46.0
50.0													7.2		7.4	6.9	50.0
54.0															52.0m/7.0	6.2	54.0
58.0																56.0m/5.9	58.0
Reeves			4				4					4			3		Reeves

Working radius (m)	33.5								Boom length (m)
	45.7				51.8				Jib length (m)
	88°	83°	65°	60°	88°	83°	65°	60°	Boom angle
18.0	23.2								18.0
20.0	21.5				16.6				20.0
22.0	20.0				15.3				22.0
24.0	18.6	20.9			14.2				24.0
26.0	17.4	19.3			13.2	14.7			26.0
28.0	16.4	18.0			12.3	13.7			28.0
30.0	14.8	16.9			11.6	12.8			30.0
34.0	12.3	14.5			10.3	11.2			34.0
38.0	10.3	12.1			9.1	10.0			38.0
42.0	8.8	10.2			8.2	8.9			42.0
46.0	44.0m/8.1	8.7	7.6		6.3	7.9			46.0
50.0		48.0m/8.1	7.1	52.0m/5.8	4.1	6.7	52.0m/6.4		50.0
54.0			6.3	5.8		4.1	6.0		54.0
58.0			5.7	5.2			5.3	4.9	58.0
62.0				4.6			4.7	4.3	62.0
66.0							64.0m/4.5	3.8	66.0
70.0								68.0m/3.6	70.0
Reeves			2				2		Reeves

Note: Ratings according to EN13000.
Ratings shown in [] are determined by the strength of the boom or other structural components. Refer to notes P21 and P22.





ASIAGROUP LEASING PTE LTD

NO.3 PIONEER PLACE SINGAPORE 627804 TEL:+65 67562288 FAX:+65 67568822



Unit: metric ton

Counterweight: 60.0 t, Carbody weight: 20.0 t

39.6 m Boom Length	39.6																Boom length (m)
	21.3				27.4				33.5				39.6				Jib length (m)
	88°	83°	65°	60°	88°	83°	65°	60°	88°	83°	65°	60°	88°	83°	65°	60°	Boom angle
10.0	47.4																10.0
12.0	47.4				47.4												12.0
14.0	43.4				43.0				37.7								14.0
16.0	38.1	39.7			37.7				37.0				29.8				16.0
18.0	32.2	34.2			32.1				31.9				29.3				18.0
20.0	27.6	29.8			27.6	29.6			27.4	29.2			27.6				20.0
22.0	24.0	26.4			24.1	26.2			23.9	25.9			24.0	25.5			22.0
24.0		23.7			21.2	23.5			21.0	23.2			21.2	23.1			24.0
26.0		21.4			18.9	21.2			18.7	20.9			18.8	20.9			26.0
28.0					17.0	19.3			16.8	19.0			16.9	19.0			28.0
30.0						17.7			15.2	17.4			15.3	17.4			30.0
34.0			12.4			32.0m/16.3			32.0m/13.8	14.8			12.7	14.7			34.0
38.0			11.0	10.1			10.4			12.6			10.7	12.4			38.0
42.0				9.1			9.4	44.0m/8.2			8.7			10.5			42.0
46.0							44.0m/8.8	7.7			8.0	7.1		44.0m/9.7	7.7		46.0
50.0											7.1	6.6			6.9	52.0m/5.9	50.0
54.0												52.0m/6.2			6.1	5.6	54.0
58.0															56.0m/5.8	4.9	58.0
Reeves			4				4				3			3			Reeves

39.6 m Boom Length	39.6								Boom length (m)
	45.7				51.8				Jib length (m)
	88°	83°	65°	60°	88°	83°	65°	60°	Boom angle
18.0	23.3							18.0	
20.0	21.6				16.7			20.0	
22.0	20.1				15.4			22.0	
24.0	18.7				14.3			24.0	
26.0	17.6	19.8			13.2	15.1		26.0	
28.0	16.5	18.5			12.3	14.0		28.0	
30.0	15.0	17.1			11.6	13.1		30.0	
34.0	12.4	14.5			10.3	11.5		34.0	
38.0	10.4	12.5			9.2	10.2		38.0	
42.0	8.8	10.5			8.2	9.1		42.0	
46.0	44.0m/8.2	8.9			6.0	8.1		46.0	
50.0		48.0m/8.3	6.5		3.7	6.6	52.0m/5.6	50.0	
54.0			5.8	56.0m/4.7		3.9	5.4	54.0	
58.0			5.1	4.6			4.8	60.0m/3.8	58.0
62.0			4.6	4.0			4.2	3.7	62.0
66.0				64.0m/3.8			3.7	3.2	66.0
70.0							68.0m/3.5	2.8	70.0
Reeves			2			2			Reeves

Note: Ratings according to EN13000.
 Ratings shown in are determined by the strength of the boom or other structural components.
 Refer to notes P21 and P22.





ASIAGROUP LEASING PTE LTD

NO.3 PIONEER PLACE SINGAPORE 627804 TEL:+65 67562288 FAX:+65 67568822



Unit: metric ton

Counterweight: 60.0 t, Carbody weight: 20.0 t

45.7 m Boom Length	45.7																	Boom length (m)
	21.3				27.4				33.5				39.6				Jib length (m)	
	Boom angle	88°	83°	65°	60°	88°	83°	65°	60°	88°	83°	65°	60°	88°	83°	65°	60°	Boom angle
Working radius (m)	10.0	47.4																10.0
	12.0	43.8			41.2													12.0
	14.0	38.3			37.5				33.0									14.0
	16.0	33.9			33.2				32.2				26.6					16.0
	18.0	30.4	33.7		29.6				28.9				26.1					18.0
	20.0	27.5	29.5		26.7	29.2			26.1	28.7			25.5					20.0
	22.0	24.3	26.1		24.3	25.8			23.7	25.6			23.1					22.0
	24.0		23.4		21.4	23.1			21.3	22.9			21.1	22.8				24.0
	26.0		21.1		19.1	20.9			19.0	20.6			19.1	20.5				26.0
	28.0				17.1	19.0			17.1	18.7			17.1	18.7				28.0
	30.0					17.4			15.4	17.2			15.4	17.1				30.0
	34.0						32.0m/16.0		12.8	14.6			12.8	14.5				34.0
	38.0							40.0m/8.9		12.6			10.7	12.5				38.0
	42.0			10.3										11.0				42.0
	46.0			40.0m/9.6	8.0			8.7						44.0m/10.2	48.0m/6.2			46.0
	50.0				44.0m/7.8			7.7	6.6			7.4						50.0
	54.0							6.2				6.5	5.4		6.2			54.0
	58.0											52.0m/6.2	5.1		5.5	4.3		58.0
	62.0												56.0m/4.8		4.9	4.2	3.7	62.0
Reeves				4				4				3			2			Reeves

45.7 m Boom Length	45.7																	Boom length (m)
	45.7				51.8				Jib length (m)				Boom length (m)					
	Boom angle	88°	83°	65°	60°	88°	83°	65°	60°	88°	83°	65°	60°	88°	83°	65°	60°	Boom angle
Working radius (m)	18.0	21.4																18.0
	20.0	21.0				16.8												20.0
	22.0	20.2				15.5												22.0
	24.0	18.8				14.3												24.0
	26.0	17.6	20.3			13.3												26.0
	28.0	16.6	18.4			12.5	14.4											28.0
	30.0	15.1	16.8			11.7	13.4											30.0
	34.0	12.5	14.3			10.3	11.7											34.0
	38.0	10.5	12.3			9.2	10.4											38.0
	42.0	8.9	10.7			8.2	9.2											42.0
	46.0	44.0m/8.2	9.2			5.6	8.2											46.0
	50.0		7.9	52.0m/5.0		3.3	6.5											50.0
	54.0			5.0			3.7	56.0m/4.3										54.0
	58.0			4.5	3.3		56.0m/2.6	4.2										58.0
	62.0			4.0	3.3			3.6	64.0m/2.8									62.0
	66.0			64.0m/3.8	2.9			3.2	2.6									66.0
	70.0				68.0m/2.7			2.8	2.2									70.0
	74.0								72.0m/2.0									74.0
Reeves				2				2										Reeves

Note: Ratings according to EN13000.

Ratings shown in are determined by the strength of the boom or other structural components. Refer to notes P21 and P22.





ASIAGROUP LEASING PTE LTD

NO.3 PIONEER PLACE SINGAPORE 627804 TEL:+65 67562288 FAX:+65 67568822



Unit: metric ton

Counterweight: 60.0 t, Carbody weight: 20.0 t

51.8 m Boom Length	51.8																	Boom length (m)
	21.3				27.4				33.5				39.6				Jib length (m)	
	88°	83°	65°	60°	88°	83°	65°	60°	88°	83°	65°	60°	88°	83°	65°	60°	Boom angle	
Working radius (m)	12.0	37.2			35.4												12.0	
	14.0	32.7			31.6			28.8									14.0	
	16.0	29.2			28.1			27.2				23.6					16.0	
	18.0	26.3	31.9		25.3			24.4				23.1					18.0	
	20.0	23.9	28.6		22.9	27.5		22.0				21.2					20.0	
	22.0	21.8	25.7		20.9	24.9		20.1	23.5			19.3					22.0	
	24.0	20.2	23.0		19.2	22.6		18.4	21.5			17.7	20.6				24.0	
	26.0		20.8		17.8	20.6		16.9	19.7			16.3	19.0				26.0	
	28.0		18.9		16.5	18.7		15.7	18.1			15.1	17.4				28.0	
	30.0					17.1		14.6	16.7			14.0	16.0				30.0	
	34.0					32.0m/15.8		12.7	14.4			12.2	13.8				34.0	
	38.0			9.2						12.5		10.7	12.0				38.0	
	42.0			8.3			44.0m/7.5					40.0m/10.0	10.6				42.0	
	46.0			44.0m/7.8	6.5			7.1			6.1			44.0m/10.0			46.0	
	50.0				48.0m/6.1			6.2	5.3		5.8	52.0m/4.1			52.0m/5.0		50.0	
	54.0								52.0m/5.0		5.1	4.1			4.8		54.0	
	58.0											3.8			4.3	3.2	58.0	
	62.0													60.0m/4.0	3.0		62.0	
	66.0														64.0m/2.8		66.0	
Reeves			3				3			3			2				Reeves	

51.8 m Boom Length	51.8								Boom length (m)
	45.7				51.8				Jib length (m)
	88°	83°	65°	60°	88°	83°	65°	60°	Boom angle
Working radius (m)	18.0	19.2							18.0
	20.0	18.9			15.7				20.0
	22.0	18.5			15.5				22.0
	24.0	17.0			14.4				24.0
	26.0	15.6	18.0		13.4				26.0
	28.0	14.3	16.6		12.5	14.8			28.0
	30.0	13.3	15.3		11.7	13.7			30.0
	34.0	11.5	13.1		10.4	12.0			34.0
	38.0	10.0	11.3		9.2	10.6			38.0
	42.0	8.8	9.9		8.2	9.2			42.0
	46.0	44.0m/8.3	8.8		5.3	8.1			46.0
	50.0		7.8		3.0	6.4			50.0
	54.0			3.9		3.6			54.0
	58.0			3.9		56.0m/2.4	3.3		58.0
	62.0			3.4			3.0		62.0
	66.0			3.0			2.6		66.0
	70.0						2.2		70.0
	74.0						72.0m/2.0		74.0
Reeves			2			2			Reeves

Note: Ratings according to EN13000.
Ratings shown in are determined by the strength of the boom or other structural components. Refer to notes P21 and P22.





ASIAGROUP LEASING PTE LTD

NO.3 PIONEER PLACE SINGAPORE 627804 TEL:+65 67562288 FAX:+65 67568822



Unit: metric ton

Counterweight: 60.0 t, Carbody weight: 20.0 t

54.9 m Boom Length	54.9																Boom length (m)
	21.3				27.4				33.5				39.6				Jib length (m)
	88°	83°	65°	60°	88°	83°	65°	60°	88°	83°	65°	60°	88°	83°	65°	60°	Boom angle
12.0	33.7			32.6													12.0
14.0	29.8			28.8				26.9									14.0
16.0	26.7			25.6				24.7				22.2					16.0
18.0	24.1	29.6		23.1				22.1				21.2					18.0
20.0	21.9	26.5		21.0	24.9			20.0				19.2					20.0
22.0	20.2	24.0		19.2	22.7			18.2	21.5			17.5					22.0
24.0	18.7	21.9		17.6	20.6			16.7	19.7			16.0					24.0
26.0		20.1		16.3	18.9			15.4	18.0			14.7	17.3				26.0
28.0		18.6		15.2	17.5			14.3	16.6			13.6	15.8				28.0
30.0				14.2	16.2			13.3	15.3			12.6	14.6				30.0
34.0						32.0m/15.1		11.6	13.2			11.0	12.5				34.0
38.0			40.0m/8.1						11.6			9.7	10.9				38.0
42.0			8.0									40.0m/9.1	9.6				42.0
46.0			44.0m/7.5				6.6				48.0m/5.3		44.0m/9.1				46.0
50.0							5.9				5.3				52.0m/4.2		50.0
54.0											4.8				4.2		54.0
58.0											56.0m/4.5				3.9		58.0
62.0															3.4		62.0
Reeves			3				3				3				2		Reeves

Working radius (m)	54.9																Working radius (m)
	45.7								51.8								Jib length (m)
	88°	83°	65°	60°	88°	83°	65°	60°	88°	83°	65°	60°	88°	83°	65°	60°	Boom angle
18.0	18.2																18.0
20.0	17.9							14.9									20.0
22.0	16.7							14.6									22.0
24.0	15.2							14.3									24.0
26.0	14.0	16.2						13.2									26.0
28.0	12.9	15.0						12.1	14.0								28.0
30.0	11.9	13.8						11.2	13.0								30.0
34.0	10.3	11.8						9.6	11.0								34.0
38.0	9.0	10.2						8.3	9.4								38.0
42.0	7.9	8.9						7.2	8.2								42.0
46.0	44.0m/7.4	7.8						5.2	7.1								46.0
50.0		7.0						2.8	6.3								50.0
54.0			56.0m/3.2						3.5								54.0
58.0			3.2					56.0m/2.3	60.0m/2.9								58.0
62.0			3.1						2.7								62.0
66.0			2.7						2.3								66.0
70.0			68.0m/2.5														70.0
Reeves			2						2								Reeves

Note: Ratings according to EN13000.
Ratings shown in [] are determined by the strength of the boom or other structural components. Refer to notes P21 and P22.





Luffing Boom Lifting Capacities with Luffing Jib Attached at 23 Degree Boom to Luffing Jib Offset Angle

Unit: metric ton

Counterweight: 60.0 t,
Carbody weight: 20.0 t

21.3 m Boom Length	Boom length (m)	21.3					
	Jib length (m)	21.3	27.4	33.5	39.6	45.7	51.8
	7.0	70.6	67.8	65.0	61.5	57.9	53.6
	8.0	70.6	67.8	65.0	61.5	57.9	53.6
	9.0	70.6	67.8	65.0	61.5	57.9	53.6
	10.0	66.0	63.7	61.4	58.5	55.7	52.3
	12.0	48.7	46.6	44.5	41.8	39.2	36.1
	14.0	37.8	35.8	33.8	31.3	28.9	25.9
	16.0	30.3	28.4	26.5	24.1	21.8	19.0
	18.0	24.7	22.8	21.0	18.7	16.6	13.9
	20.0	20.3	18.5	16.8	14.7	12.6	10.0
	21.0	18.5	16.7	15.1	12.9	10.9	8.4
	Reeves	6	6	5	5	5	5

27.4 m Boom Length	Boom length (m)	27.4					
	Jib length (m)	21.3	27.4	33.5	39.6	45.7	51.8
	8.0	71.1	68.6	66.1	62.9	59.8	56.0
	9.0	71.1	68.6	66.1	62.9	59.8	56.0
	10.0	66.2	64.1	62.0	59.3	56.7	53.5
	12.0	48.9	47.0	45.0	42.6	40.2	37.3
	14.0	38.0	36.2	34.4	32.1	29.8	27.1
	16.0	30.5	28.7	27.0	24.8	22.7	20.2
	18.0	24.9	23.2	21.5	19.4	17.4	15.0
	20.0	20.5	18.9	17.3	15.3	13.4	11.0
	22.0	17.2	15.6	14.0	12.1	10.3	8.0
	24.0	14.4	12.9	11.4	9.5	7.7	5.5
	25.0	13.2	11.7	10.2	8.4	6.7	4.5
	Reeves	6	6	5	5	5	5

33.5 m Boom Length	Boom length (m)	33.5					
	Jib length (m)	21.3	27.4	33.5	39.6	45.7	51.8
	9.0	71.5	69.3	67.2	64.4	61.7	58.4
	10.0	64.9	62.9	60.9	58.4	55.9	52.9
	12.0	49.0	47.1	45.3	43.0	40.8	38.0
	14.0	38.0	36.2	34.5	32.4	30.3	27.8
	16.0	30.4	28.7	27.1	25.0	23.1	20.7
	18.0	24.7	23.1	21.6	19.6	17.8	15.5
	20.0	20.5	18.9	17.4	15.5	13.8	11.6
	22.0	17.0	15.5	14.1	12.2	10.5	8.4
	24.0	14.2	12.8	11.4	9.6	7.9	5.9
	26.0	12.0	10.5	9.2	7.5	5.8	
	28.0	10.1	8.7	7.4	5.7	4.1	
	30.0	8.5	7.2	5.9	4.2		
	32.0	7.2	5.8	4.6			
	Reeves	6	6	6	5	5	5

39.6 m Boom Length	Boom length (m)	39.6					
	Jib length (m)	21.3	27.4	33.5	39.6	45.7	51.8
	10.0	61.4	59.5	57.5	55.1	52.8	49.9
	12.0	48.7	46.9	45.1	42.9	40.8	38.2
	14.0	37.9	36.2	34.6	32.5	30.5	28.1
	16.0	30.2	28.6	27.1	25.2	23.3	21.0
	18.0	24.6	23.1	21.6	19.7	18.0	15.8
	20.0	20.2	18.8	17.3	15.6	13.9	11.8
	22.0	16.8	15.3	14.0	12.2	10.6	8.6
	24.0	14.0	12.6	11.3	9.6	8.0	6.1
	26.0	11.8	10.4	9.1	7.4	5.9	4.0
	28.0	9.9	8.5	7.3	5.7	4.2	
	30.0	8.3	7.0	5.7	4.2		
	32.0	6.9	5.6	4.4			
	35.0	5.2	3.9				
	36.0	4.7					
	37.0	4.2					
	Reeves	5	5	5	5	4	4

45.7 m Boom Length	Boom length (m)	45.7					
	Jib length (m)	21.3	27.4	33.5	39.6	45.7	51.8
	11.0	51.9	50.1	48.3	46.1	43.9	41.3
	12.0	46.6	44.8	43.2	41.0	39.0	36.4
	14.0	37.7	36.1	34.5	32.5	30.6	28.3
	16.0	30.1	28.5	27.0	25.2	23.4	21.2
	18.0	24.4	22.9	21.5	19.7	18.0	16.0
	20.0	20.1	18.6	17.3	15.6	13.9	11.9
	22.0	16.6	15.2	13.9	12.2	10.7	8.8
	24.0	13.8	12.5	11.2	9.6	8.1	6.2
	26.0	11.6	10.2	9.0	7.4	6.0	4.1
	28.0	9.7	8.4	7.2	5.6	4.2	
	30.0	8.0	6.7	5.5	4.0		
	32.0	6.6	5.4	4.2			
	34.0	5.4	4.2				
	36.0	4.4					
	37.0	3.9					
	Reeves	4	4	4	4	4	4

51.8 m Boom Length	Boom length (m)	51.8					
	Jib length (m)	21.3	27.4	33.5	39.6	45.7	51.8
	12.0	44.5	42.8	41.1	39.0	37.0	34.6
	14.0	36.4	34.8	33.3	31.3	29.5	27.2
	16.0	29.7	28.2	26.8	25.0	23.3	21.1
	18.0	24.1	22.7	21.3	19.6	17.9	15.9
	20.0	19.7	18.3	17.0	15.4	13.8	11.9
	22.0	16.3	14.9	13.7	12.1	10.6	8.7
	24.0	13.5	12.2	11.0	9.4	8.0	6.2
	26.0	11.2	10.0	8.8	7.2	5.8	4.1
	28.0	9.4	8.1	6.9	5.4	4.1	
	30.0	7.7	6.4	5.3	3.8		
	32.0	6.3	5.1	4.0			
	34.0	5.1	3.9				
	36.0	4.0					
	Reeves	4	4	4	3	3	3

54.9 m Boom Length	Boom length (m)	54.9					
	Jib length (m)	21.3	27.4	33.5	39.6	45.7	51.8
	13.0	39.3	37.7	36.2	34.2	32.3	30.0
	14.0	35.6	34.0	32.5	30.6	28.8	26.6
	16.0	29.4	27.9	26.5	24.7	23.0	20.9
	18.0	23.9	22.5	21.2	19.5	17.8	15.9
	20.0	19.6	18.2	16.9	15.3	13.7	11.8
	22.0	16.1	14.8	13.5	12.0	10.5	8.6
	24.0	13.3	12.0	10.8	9.3	7.9	6.1
	26.0	11.1	9.8	8.6	7.1	5.7	4.0
	28.0	9.1	7.9	6.7	5.2	3.9	
	30.0	7.5	6.3	5.2	3.7		
	32.0	6.1	4.9	3.8			
	34.0	4.9	3.7				
	35.0	4.3					
	Reeves	3	3	3	3	3	3

Note: Ratings according to EN13000.
Ratings shown in are determined by the strength of the boom or other structural components.
Refer to notes P21 and P22.





ASIAGROUP LEASING PTE LTD

NO.3 PIONEER PLACE SINGAPORE 627804 TEL:+65 67562288 FAX:+65 67568822

Base Machine + Boom Base

With boom base, trans-lifter, main and aux. winches (non free-fall) including wire rope, self removal device
Weight: approx. 44,000 kg*, Width: 3,500 mm

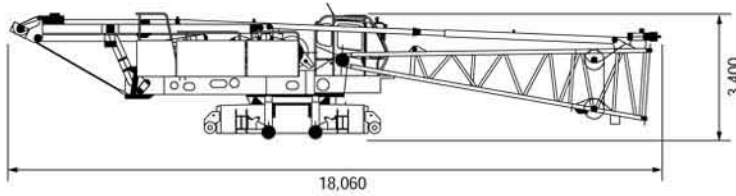

Crawler

Weight: 17,155 kg, Width: 1,070 mm

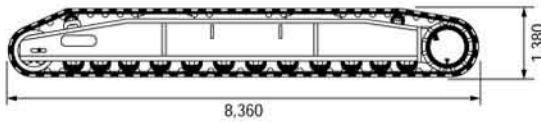

Gantry

Weight: 2,700 kg

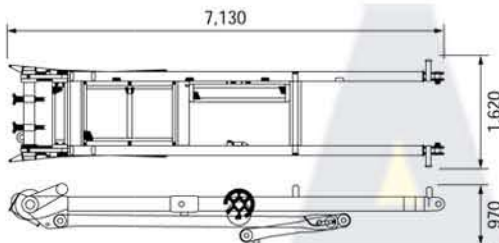

Counterweight A

Weight: 10,000 kg

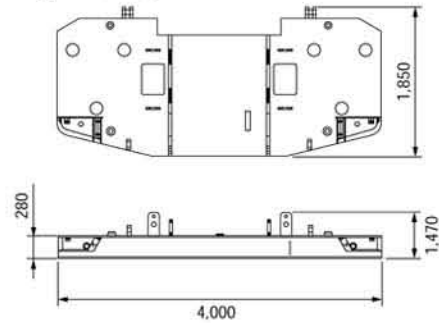

Counterweight B

Weight: 5,000 kg x 10 pieces

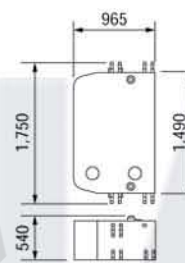

Carbody Weight A

Weight: 5,000 kg x 2 pieces

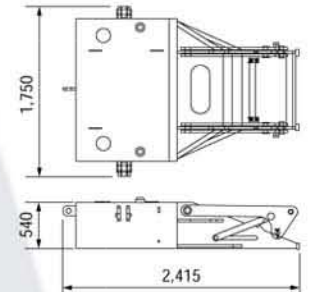

Carbody Weight B

Weight: 5,000 kg x 2 pieces

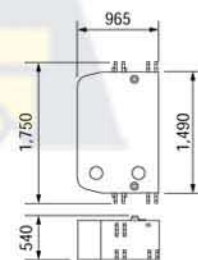

Boom Base

Weight: 2,620 kg

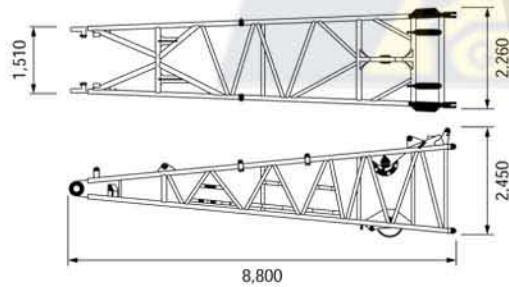

Boom Top

Weight: 2,240 kg (with Guy Cables)

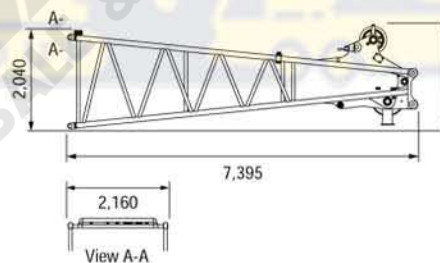

Jib Base with Strut (For Crane)

Weight: 510 kg, Width: 1,040 mm

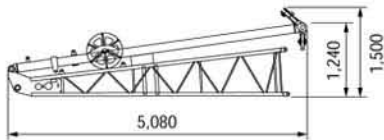

Insert Boom

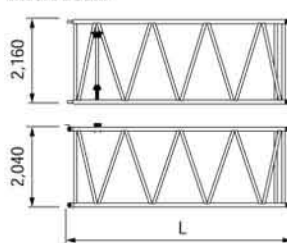

	L (mm)	Weight (kg)*
3.0m	3,180	630
6.1m	6,230	1,030
9.1m	9,280	1,420
12.2m	12,320	1,680

*with guy cables

Jib Top (For Crane)

Weight: 315 kg

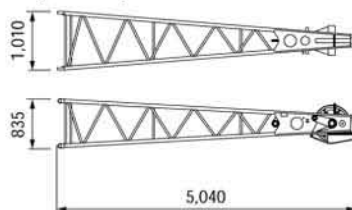

Travel Kit Assembly

Weight: 6,600 kg

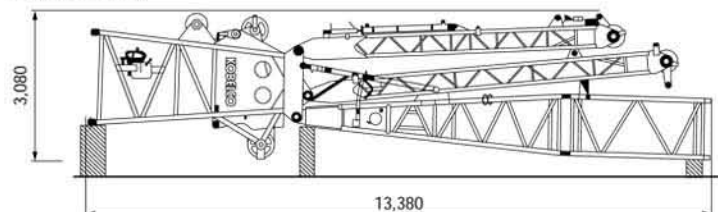

Dimensions: mm Weight: kg

Luffing Boom Top
Weight: 2,545 kg

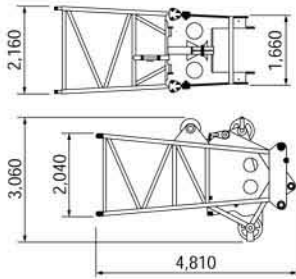

Front Strut (Luffing Jib)
Weight: 1,000 kg

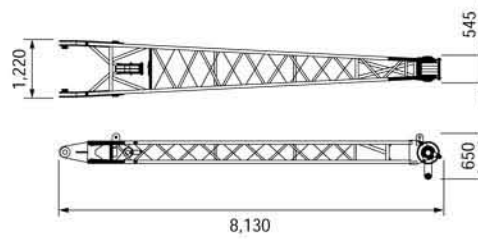

Luffing Jib Base
Weight: 1,140 kg

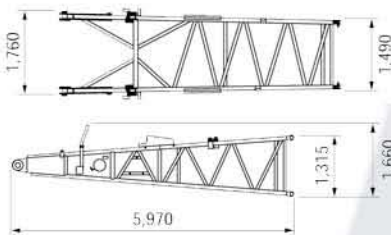

Rear Strut (Luffing Jib)
Weight: 1,090 kg

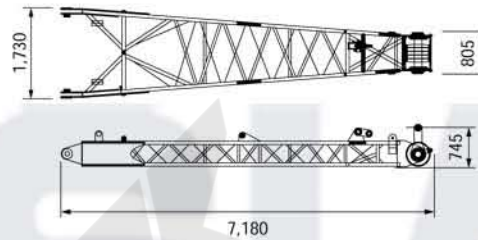

Luffing Jib Top
Weight: 1,170 kg

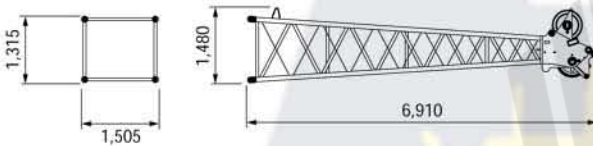

Other Attachments

Attachments	Weight	Dimensions (L x W x H)
Base machine (without boom base)	38,150 kg	10,700 mm x 3,500 mm x 3,390 mm
Trans-lifter	360 kg	1,050 mm x 1,030 mm
Boom backstop	740 kg/1 piece	7,090 mm x 360 mm
3.0 m Insert jib (for crane)	110 kg	3,130 mm x 1,020 mm x 840 mm
6.1 m Insert jib (for crane)	190 kg	6,175 mm x 1,020 mm x 840 mm
Auxiliary sheave	295 kg	2,030 mm x 740 mm x 720 mm
Upper spreader	590 kg	2,230 mm x 395 mm x 790 mm
Lower spreader	400 kg	1,500 mm x 290 mm x 780 mm
3.0 m luffing Insert jib	310 kg	3,165 mm x 1,490 mm x 1,290 mm
6.1 m luffing Insert jib	540 kg	6,210 mm x 1,490 mm x 1,290 mm
9.1 m luffing Insert jib	740 kg	9,260 mm x 1,490 mm x 1,290 mm
Luffing jib backstop	100 kg/1 piece	2,940 mm x 210 mm x 230 mm
Strut backstop (luffing jib)	180 kg/1 piece	2,890 mm x 270 mm
Auxiliary sheave (luffing jib)	380 kg	1,010 mm x 890 mm x 910 mm
Luffing jib drum	1,470 kg	840 mm x 1,620 mm x 900 mm
180-ton hook	2,800 kg	2,225 mm x 700 mm x 1,000 mm
110-ton hook	1,730 kg	2,140 mm x 540 mm x 700 mm
70-ton hook	1,200 kg	1,825 mm x 470 mm x 700 mm
35-ton hook	900 kg	1,575 mm x 365 mm x 700 mm
Ball hook	460 kg	1,200 mm x 380 mm dia.

Note: Estimated weights may vary $\pm 2\%$.

Luffing Boom 54.9 m + Luffing Jib 51.8 m

Configuration	Description	Total Weight
No.1 Low Loader Width: 3,500 mm 	Base Machine = Including 3rd winch Translifter All wire ropes	Approx. 44.00ton
No.2 Semi Loader 	Crawler No.1 = Crawler No.2 = Luffing Jib Top = Total =	17.16 ton 17.16 ton 1.17 ton <hr/> 35.49 ton
No.3 Semi Loader 	Travel Kit Assembly =	6.60 ton
No. 4 Tent Side Truck 	Counterweight B (4 x 5.00 ton) = 9.1 m Insert Boom x 1 = 9.1 m Luffing Insert Jib x 1 = 3.0 m Insert Boom x 1 = Total =	20.00 ton 1.42 ton 0.74 ton 0.63 ton <hr/> 22.79 ton
No.5 Tent Side Truck 	Counterweight B (4 x 5.00 ton) = 9.1 m Insert Boom x 1 = 9.1 m Luffing Insert Jib x 1 = 3.0 m Insert Boom x 1 = Total =	20.00 ton 1.42 ton 0.74 ton 0.53 ton <hr/> 22.69 ton
No.6 Tent Side Truck 	Counterweight B (2 x 5.00 ton) Carbody Weight B (2 x 5.00 ton) = 9.1 m Insert Boom x 1 = 9.1 m Luffing Insert Jib x 1 = Total =	10.00 ton 10.00 ton 1.42 ton 0.74 ton <hr/> 22.16 ton
No.7 Tent Side Truck 	Counterweight A Base = 9.1 m Insert Boom x 1 = 6.1 m Luffing Insert Jib x 1 = 3.0 m Luffing Insert Jib x 1 = Carbody Weight A (2x5.00 ton) = Total =	10.00 ton 1.42 ton 0.54 ton 0.31 ton 10.00 ton <hr/> 22.27 ton

Note: Estimated weights may vary \pm 2%.

This transport plan depends on specifications of your trailers/trucks and the areas or countries where you transport.



Standard Equipment

Upper structure/Lower structure

Counterweight: 60.0 ton (total weight)
Carbody weight: 20.0 ton (total weight)
1,070 mm shoe crawlers
Batteries (170 Ah/20 HR)
Trans-lifter (jack system)
Gantry raising/lowering cylinder
Electric hand throttle grip
Variable boom hoist speed controller
Swing neutral-free/brake select switch
Side deck for cab
Side deck (right side guard)
Steps (crawlers)
Two front working lights
Tools (for routine maintenance)
Two rear view mirrors
Electric fuel pump
Counterweight self removal
Crawler self removal
Cable roller (for boom)

Cab/Control

Boom hoist pedal (EU area only)
Air conditioner
Cup holder
Ashtray
Cigar lighter
Intermittent wiper & window washer (skylight and front window)
Sun visor
Roof blind
Floor mat (cloth)
Foot rest
Shoe tray
Level gauge (operator cabin)

Safety Device

Load Moment Indicator (with boom lowering slow stop function)
LMI release key (for hook over-hoist prevention device and boom over-hoist prevention device)
LCD multi display
Ultimate stop function for boom over-hoist
Function lock lever
Propel lever lock
Mechanical drum lock pawl (main, aux. and boom hoist)
Signal horn
Swing parking brake
Mechanical swing lock pin (four positions)
Swing flashers/warning buzzer
Cab window guard (left side)
Cab top guard
Fire extinguisher
External lamp for over-load alarm
Life hammer

